

## DuraBand® with Built-In Strap

General purpose terminal box can be attached on Duraband diameters of 63.5 mm (2½") or larger. It offers excellent protection to exposed terminals. To simplify wiring, the box has a 13 mm (½") trade size knockout [actual diameter 22 mm (7/8")] that will accept standard conduit or flexible armor cable connectors. It can be field assembled on most band heaters with screw terminals having a center distance of 22 mm (7/8").

Flexible armor cable for lead protection is available where abrasion is a problem.

For maximum surface contact, the torque resistant and virtually unbreakable stainless steel screw terminals are securely fastened to a connecting jumper, assuring positive contact with the windings and providing maximum amperage carrying capacity. For other terminal or lead arrangements, see pages 13 through 18.

Specially designed mounting brackets with ¼"-20 socket cap screws are used to draw the built-in strap to a high degree of tension. This tension exerts the great amount of drawing power required to pull the heating element assembly against the cylinder evenly and tightly across its entire width, thus eliminating all air gaps that can cause premature heater failure. The number of bracket assemblies used increases as the width of a Duraband heater increases.

Specially treated rust-resistant steel sheath casing provides the best combination of physical strength, high emissivity and good thermal conductivity to heated cylindrical parts, good for sheath temperatures up to 480°C (900°F).

Specially selected grade and thickness of mica sheet is used to insulate the windings, providing excellent thermal conductivity and dielectric strength.

The gauge of nickel-chrome resistance ribbon wire is selected to achieve the lowest internal element temperatures possible, resulting in maximum heater life. The ribbon wire is wound evenly spaced on a specially selected mica strip, providing even heat distribution and thus eliminating hot spotting that can cause premature heater failure.

Duraband's built-in strap is a unique design feature. A low thermal expansion alloy sheath is used for the outer sheath, covering the entire width of the band heater.



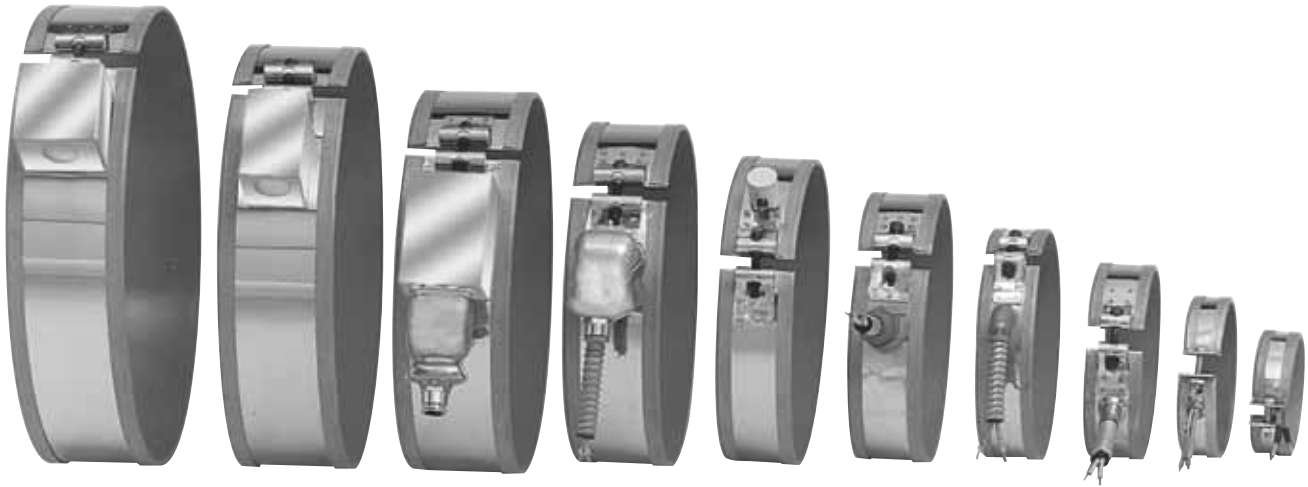

- Built-In Bracket for Superior Clamping
- Unbreakable and Torque-Resistant Screw Terminals
- Temperatures Up to 480°C (900°F)
- Full Width Stainless Steel Built-In Strap
- Flexibility to Incorporate Holes and Cutouts
- Available Two-Piece and Expandable Designs
- Best Mica Insulated Heater on the Market
- Faster Delivery than Any Other Type of Heater Band
- Most Economical Among Various Heater Bands
- Most Versatile and Commonly Used Heater Band

#### Typical Applications

- Plastic Injection Molding Machines
- Plastic Extruders
- Oil Reclamation Equipment
- Food and Candy Extruders
- Drum Heating
- Extrusion Dies
- Holding Tanks
- Blow Molding Machines
- Vending Machines
- Barrels and Heads
- Food Service Warming
- Autoclaves and Sterilizers
- Metallurgical Analyzers
- Fluidized Beds
- Hot Runner Molds
- Pulp and Paper Processing Equipment

#### Designed For Trouble-Free Service

The Duraband heater design is the result of many years of research, development and testing for a reliable mica insulated band heater that can perform at the higher operating temperatures [up to 480°C (900°F)] essential to process high temperature resins, providing long, efficient service necessary for today's high productivity of plastic extruders, injection and blow molding machines.

Duraband is a proven heater design for good life efficiency and dependability. It assures maintaining the lowest winding temperatures possible, keeping a low-mass heating element assembly for fast heat-up and quick thermal response to controls. It incorporates the low thermal expansion built-in strap, a unique design feature.

#### Advantages and Variations

Duraband mica insulated heaters are widely used on operations involving heating of cylindrical surfaces and are manufactured in a full range of standard construction variations, physical dimensions, electrical ratings, and a complete arrangement of screw terminals and lead terminations. (See pages 13 through 18).

However, these standard Duraband heater variations and terminations do not represent the full extent of our capabilities. OMEGA's engineering staff, with many years of experience in heat processing and temperature control applications, can assist you in designing the right Duraband heater for your specific application.

## Standard Specifications and Tolerances

### Performance Ratings

**Maximum Temperature:**

**Standard Sheath:** 482°C (900°F)

**Nominal Watt Density:** 3 to 7 Watt/cm<sup>2</sup> (20 to 45 Watt/in<sup>2</sup>)

**Maximum Watt Density:** Dependent on heater size and operating temperature

### Electrical Ratings

**Maximum Voltage:** 480 Vac

**Dual Voltage or 3-Phase:** Available depending on heater design

**Maximum Amperage:**

**Lead Wire Termination:** 10 Amp

**Screw Terminations:** 8-32 UNF—20 Amp;  
10-32 UNF—25 Amp

**Resistance Tolerance:** 10%, -5%

**Wattage Tolerance:** 5%, -10%

### Physical Size Construction Limitations

**Minimum Width:** 19.1 mm (¾")

**Width Tolerance:** 1.59 mm (±1/16")

**Minimum Inside Diameter:** 22.1 mm (7/8")

**Nominal Gap:** 9.5 mm (¾")—if a larger gap is required for probes or thermocouples, specify when ordering

### Built-In Brackets

Heater Width	Number of Brackets
38 to 76 mm (1½ to 3")	1
79 to 127 mm (3⅛ to 5")	2
130 to 145 mm (5⅛ to 6⅞")	3
178 to 254 mm (7 to 10")	4
257 to 381 mm (10⅛ to 15")	5

*If tighter tolerances are required, contact OMEGA.*

**CAUTION:** Exposed electrical wiring on band heater installations is a violation of Electrical Safety Codes including O.S.H.A.

### Minimum ID and Width for Construction/Clamping Styles

Style	Minimum ID		Minimum Width	
	mm	inch	mm	inch
NB	50.8	2	31.8	1¼
NS	76.2	3	31.8	1¼
NE	63.5	2½	31.8	1¼
SB	22.1	7/8	19.1	¾
SS	50.8	2	19.1	¾
SE	63.5	2½	31.8	1¼
FB	25.4	1	19.1	¾
FS	50.8	2	19.1	¾
FE	63.5	2½	31.8	1¼
SL	101.6	4	31.8	1¼
NSL	101.6	4	31.8	1¼
NEL	101.6	4	31.8	1¼
LT	177.8	7	38.1	1½
LS	177.8	7	38.1	1½
LE	177.8	7	38.1	1½
TWL	25.4	1	25.4	1
RNB	134.7	5½	25.4	1
RNS	254	10	25.4	1

**Note:** Refer to individual descriptions for further information. Actual heater minimums will be a combination of termination and construction/strap styles.

## Maximum Watt Densities

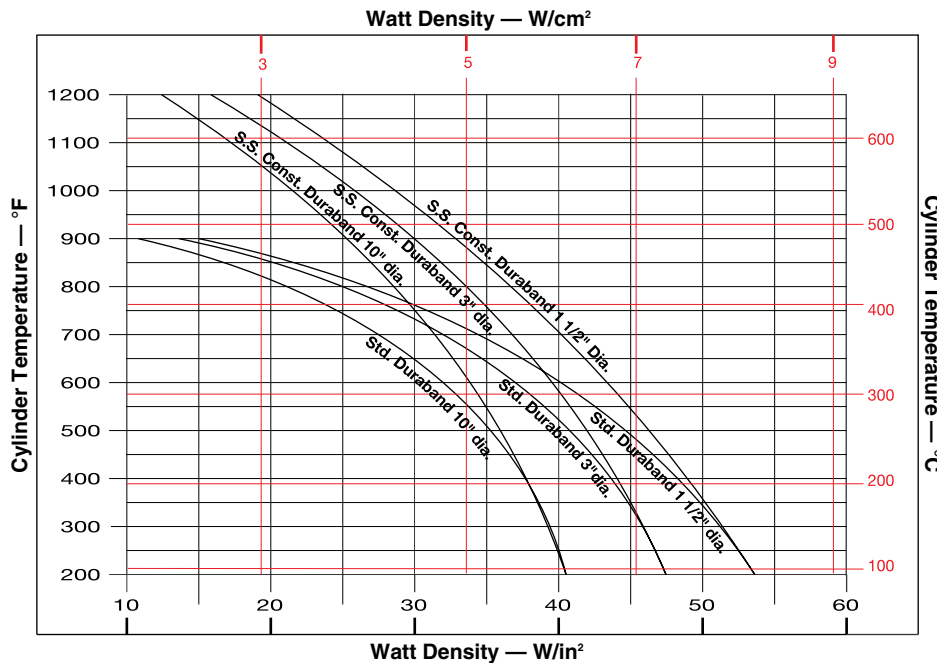

### Maximum Allowable Watt Density

The chart displays the maximum Watt Density curves for various diameter heaters. Use this chart when determining the appropriate wattage value for your chosen heater.

Be aware that certain factors will require you to derate the watt density (Watt/in<sup>2</sup>) of your heater selection.

**CAUTION: Failure to adhere to the maximum allowable watt density per heater size will result in poor operating life.**

### Correction Factors

For heaters wider than 76.2 mm (3"), reduce maximum recommended watt density from chart by 20%.

For applications using insulating shroud, reduce maximum recommended watt density from chart by 25%.

### Calculating Maximum Watt Density

#### Factors to be Taken into Consideration:

- A. Type of controls
- B. Voltage variations
- C. Machine cycling rate
- D. Type of resin being processed
- E. Coefficient of thermal expansion and conductivity of the cylinder
- F. Designing a heater that closely matches the wattage requirement will decrease the frequency of cycling and temperature overshoot, thereby increasing the life of the heater.

### Once These Factors have been Established, Proceed with the Following Steps:

1. Determine the maximum operating temperature.
2. Calculate the total wattage required to obtain the maximum operating temperature.
3. Determine the quantity and size of the heater bands to be used. 38 through 76 mm (1½ through 3") wide band heaters have proven to be the most efficient and reliable in most cylindrical heating applications.
4. Determine individual band heater wattage by dividing the total required wattage by the quantity of band heaters selected.
5. Determine the band heater watt density by subtracting unheated areas from the band heater diameter created by screw terminals, gaps, holes, and cutouts (see formula below).
6. Determine if the required watt density previously calculated exceeds the maximum recommended watt density. Note the maximum cylinder temperature required on the left-hand side of the graph, follow the horizontal line until it intersects with the line of the band heater being used, and read directly down to obtain the maximum recommended watt density (Watt/in<sup>2</sup>).
7. If the calculated watt density is higher than the recommended value, it must be corrected or it will cause poor heater life. This can be accomplished by using more band heaters, lowering the heater wattage, or using a different construction type or a different type of band heater.
8. Should you have a problem in selecting the proper band heater or establishing watt density for your application, contact one of the qualified engineers at OMEGA.

Nominal Unheated Areas	
Construction Style	Unheated Area to Subtract
One-piece band	1" x width
Two-piece band	2" x width
Holes and cutouts	Size + ½" x width

### Watt Density Formula

Wattage

$$\text{Watt Density (Watt/in}^2\text{)} = \frac{\text{Wattage}}{[3.14 \times (\text{Band ID}) - \text{Gap-1}\frac{3}{8}] \times \text{Band Width} - \text{Unheated Area (see table)}}$$

Unheated Area (See Table) = Unheated area for construction style + unheated area for any holes or cutouts

## Construction Styles

### 3 Construction Types



Shown with Type NB Built-In Strap

#### One-Piece Band

The one-piece construction is available on any screw or lead termination and clamping variation. It can be used where band heaters can be slipped over the end of the cylinder.



Shown with Type NS Built-In Strap

#### Two-Piece Band

The two-piece construction is available on any screw or lead and clamping variation. The Duraband two-piece design provides a built-in hinge, making handling and installation easier. It is used on large cylinders or where the heater cannot be slipped over the end of the cylinder. Two-piece band heaters are rated at watts and volts per each half when ordering.

**Note:** Multiple segment designs are recommended on larger diameter [typically larger than 381 mm (15")] heaters to improve the clamping force and increase the surface contact between the heater and the barrel for efficient heat transfer.



Shown with Type NE Built-In Strap

#### One-Piece Expandable Band

The one-piece expandable construction is available on any screw or lead and clamping variation. It can be used where a one-piece band heater would have to be expanded to fit over the barrel during installation, rather than slipped over the end of the barrel.

**Note:** The one-piece expandable band should not be opened and closed more than twice.

## Construction/Clamping Variations

### Standard Built-In Strap Clamping (Low Thermal Expansion)

The built-in strap is available with any screw or lead termination and construction variation. The built-in strap eliminates the use of awkward-to-handle separate straps, providing more drawing power than any other type of clamping system. The Duraband with built-in strap is standard on many designs.

#### Type NB—One-Piece Band

**Minimum ID:** 50.8 mm (2")  
**Minimum Width:** 31.8 mm (1¼")

#### Type NS—Two-Piece Band

**Minimum ID:** 76.2 mm (3")  
**Minimum Width:** 31.8 mm (1¼")

#### Type NE—One-Piece Expandable Band

**Minimum ID:** 63.5 mm (2½")  
**Minimum Width:** 31.8 mm (1¼")

Type NB shown

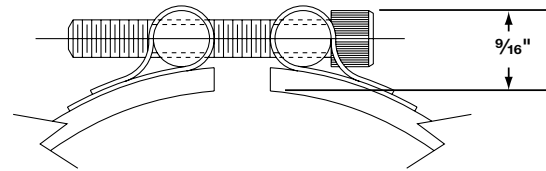

### Wedge Lock

Wedge lock clamping is designed for applications where mounting space is severely limited. It lends itself mainly to small diameter nozzle heaters.

#### Type TWL—One-Piece Band

**Minimum ID:** 25.4 mm (1")  
**Minimum Width:** 25.4 mm (1")  
**Maximum Width:** 88.9 mm (3½")

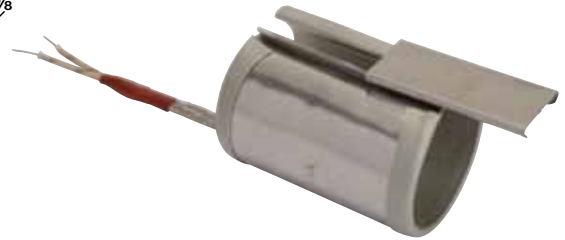
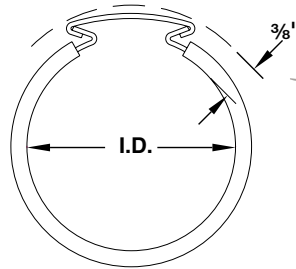

### Separate Straps

The separate strap clamping is available with any screw or lead termination and construction variation. It is strongly recommended that the Duraband with built-in strap design be used whenever possible because it provides more drawing power than any other type of clamping system.

#### Type SB—One-Piece Band

**Minimum ID:** 22.2 mm (7/8")  
**Minimum Width:** 19.1 mm (¾")

#### Type SS—Two-Piece Band

**Minimum ID:** 50.8 mm (2")  
**Minimum Width:** 19.1 mm (¾")

Type SB shown



#### Type SE—One-Piece Expandable Band

**Minimum ID:** 63.5 mm (2½")  
**Minimum Width:** 31.8 mm (1¼")

### Clearance Dimensions for Separate Strap Clamping

**Separate strap clearance dimensions:** Dependent on heater inside diameter. The strap dimensions are shown below.

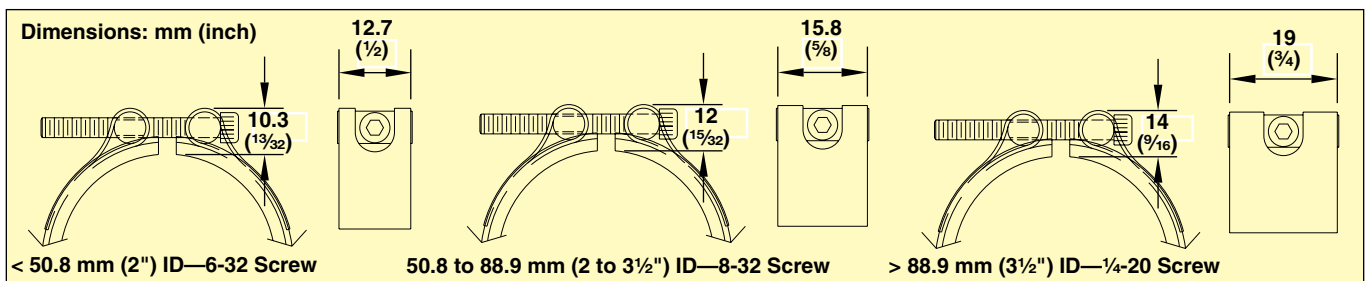

## Construction/Clamping Variations

### Spring Loaded with Built-In Bracket

The heavy duty stainless steel spring with built-in bracket is a variation on the basic Duraband® design. It is available with any screw or lead termination and construction variation. It is recommended for heaters over 305 mm (12") in diameter, and for any diameter heater used in the vertical position, to prevent the heater from slipping off the machine. The springs provide constant tension, therefore maintaining optimum surface contact against the cylinder being heated.

#### Type SL—One-Piece Band

**Minimum ID:** 101.6 mm (4")

**Minimum Width:** 31.8 mm (1¼")

#### Type NSL—Two-Piece Band

**Minimum ID:** 101.6 mm (4")

**Minimum Width:** 31.8 mm (1¼")

#### Type NEL—One-Piece Expandable Band

**Minimum ID:** 101.6 mm (4")

**Minimum Width:** 31.8 mm (1¼")



Type SL shown

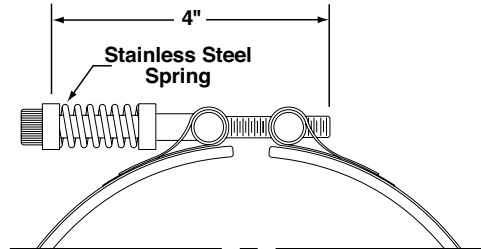

### Latch and Trunion

The latch and trunion clamping system is available with any screw or lead termination and construction variation. It is ideal in absorbing thermal expansion due to the spring loading on the screws. The latch fully opens, facilitating installation on large diameter cylinders. The outer sheath is made from a low thermal expansion alloy.

#### Type LT—One-Piece Band

**Minimum ID:** 177.8 mm (7")

**Minimum Width:** 38.1 mm (1½")

#### Type LS—Two-Piece Band

**Minimum ID:** 177.8 mm (7")

**Minimum Width:** 38.1 mm (1½")

#### Type LE—One-Piece Expandable Band

**Minimum ID:** 177.8 mm (7")

**Minimum Width:** 38.1 mm (1½")



Type LT shown

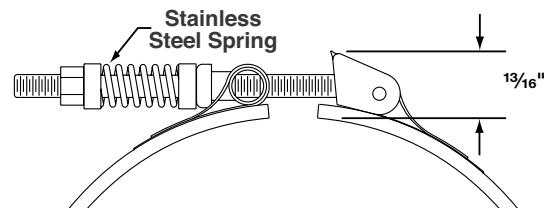

### Bent-Up Flange (Ears)

The bent-up flange clamping is available with any screw or lead termination and construction variation. The outer sheath is made from a low thermal expansion alloy. The bent-up flange design is best suited for narrow band heaters with small diameters.

#### Type FB—One-Piece Band

**Minimum ID:** 25.4 mm (1")

**Minimum Width:** 19.1 mm (¾")

#### Type FS—Two-Piece Band

**Minimum ID:** 50.8 mm (2")

**Minimum Width:** 19.1 mm (¾")

#### Type FE—One-Piece Expandable Band

**Minimum ID:** 63.5 mm (2½")

**Minimum Width:** 31.8 mm (1¼")



Type FB shown

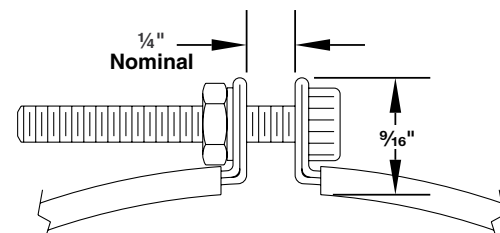

**Note:** The bent-up flange design should only be used when other clamping methods are not suitable for a specific application. OMEGA recommends built-in strap clamping be used whenever possible, especially on large diameter heaters, because it provides superior clamping power.

## Internal Reverse Bands

### Type RN—Internal Reverse Band (with Bracket Clamping)

This construction style is used to heat cylindrical surfaces from the inside on heaters 140 mm (5½") diameter and larger.

#### Type RNB—Reverse 1-Piece Construction

**ID:** 139.7 to 2854 mm (5½ to 10")  
**Width:** 25.4 to 88.9 mm (1" to 3½")  
**Maximum Voltage:** 240 Vac

#### Type RNS—Reverse 2-Piece Construction

**ID:** 254 to 508 mm (10 to 20")  
**Width:** 25.4 to 88.9 mm (1 to 3½")  
**Maximum Voltage:** 240 Vac

*For inside diameters greater than 508 mm (20"), contact OMEGA with your requirements.*

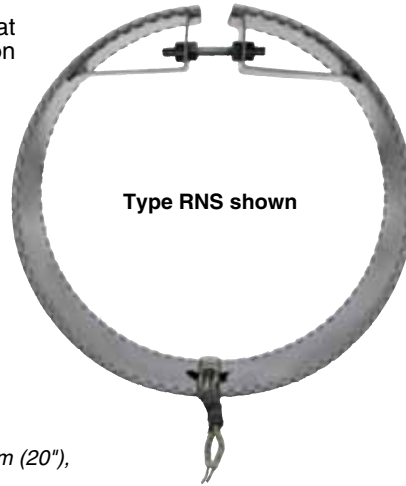

### Type RTWL—Internal Reverse Band (with Wedge Lock Clamping)

This construction style is used to heat cylindrical surfaces from the inside on heaters less than 127 mm (5") outside diameter.



**ID:** Less than 139.7 mm (5½")  
**Width:** 25.4 to 88.9 mm (1 to 3½")

## Partial Coverage

### Type NS—2-Piece with Built-In Brackets

Partial coverage band heaters are normally required when holes and cutouts will not allow the heater to sufficiently clear the machine obstructions. The preferred method of construction is the two-piece band heater with built-in brackets as illustrated. The heater is screwed down to the cylinder at the ends and the built-in low thermal expansion strap pulls the heater tightly against the cylinder being heated. The standard center of hole to edge of heater dimension is 6.3 mm (¼"). When ordering, please provide the angle of coverage from center to center of the mounting screw holes as shown.

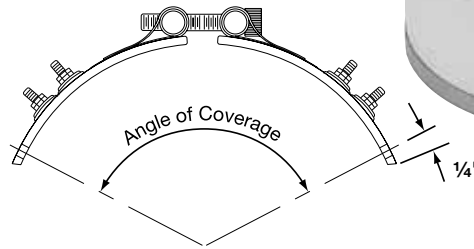

### Type PS—One-Piece with Two-Piece Separate Strap with Padded Ends

The alternate method of partial coverage construction is the one-piece band heater with a separate two-piece strap. The two-piece strap itself is screwed down at the padded ends, allowing the heater to float between the pads as illustrated. When the strap is tightened, it will pull the heater against the cylinder being heated. The standard center of hole to edge of heater dimension is 6.3 mm (¼"). When ordering, please provide the angle of coverage from center to center of the mounting screw holes as shown.

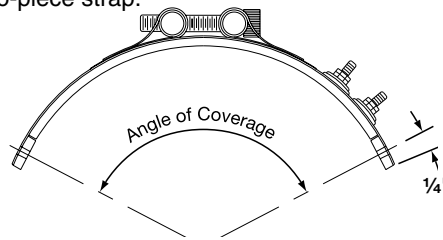

### Type NB—One-Piece with Built-In Strap Clamping

Another alternate method of partial coverage construction. The one piece with clamp screws on both sides allows it to be secured to anchor points on either side of a barrel without drilling holes into the barrel.

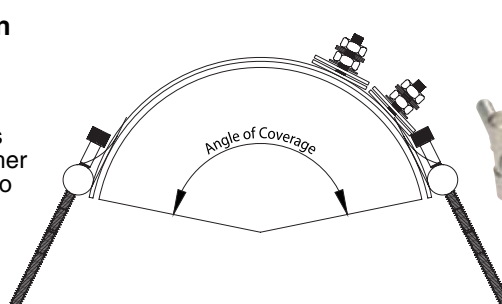



## Terminations—Stainless Steel Power Terminals: Type T1, Type T2 and Type T3

Available on any clamping or construction variation, the specially designed stainless steel power terminals are internally connected to the heater and are resistant to over-torquing.

The screw terminals are virtually unbreakable. Secure tightening of the electrical connections is essential for safety and long heater life.

### Type T1—Screw Terminals

#### One-Piece Band

**Standard Termination Location:** Each side of gap; center of width

**Minimum Inside Diameter:** 50.8 mm (2")

**Minimum Width:** 22.2 mm (7/8")

**Post Terminals:** 10-32 standard except 8-32 on <1" wide heaters and heaters with ID <3"

**Maximum Volts/Amps:** 480 Vac/25 A (10-32) or 20 A (8-32)

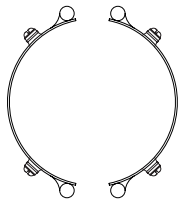
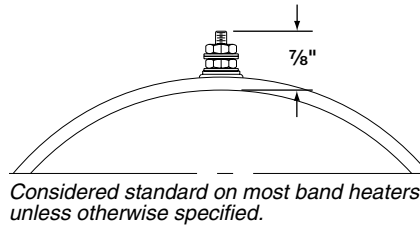

#### Two-Piece Band

**Standard Termination Location:** Next to gaps on each half; center of width

**Minimum Inside Diameter:** 50.8 mm (2")

**Minimum Width:** 22.2 mm (7/8")

**Post Terminals:** 10-32 standard except 8-32 on <1" wide heaters and heaters with ID <3"

**Maximum Volts/Amps:** 480 Vac/25 A (10-32) or 20 A (8-32) each half

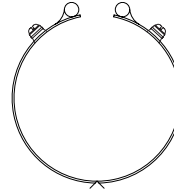

#### One-Piece Expandable Band

**Standard Termination Location:** Each side of gap; center of width

**Minimum Inside Diameter:** 63.5 mm (2½")

**Minimum Width:** 31.8 mm (1¼")

**Post Terminals:** 10-32 standard except 8-32 on heaters with ID <3"

**Maximum Volts/Amps:** 480 Vac/25 A (10-32) or 20 A (8-32)

### Type T2—Screw Terminals

#### One-Piece Band

**Standard Termination Location:** Next to gap; center of width

**Minimum Inside Diameter:** 50.8 mm (2")

**Minimum Width:** 22.2 mm (7/8")

**Post Terminals:** 10-32 standard except 8-32 on <1" wide heaters and heaters with ID <3"

**Maximum Volts/Amps:** 480 Vac/25 A (10-32) or 20 A (8-32)

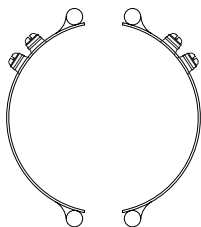
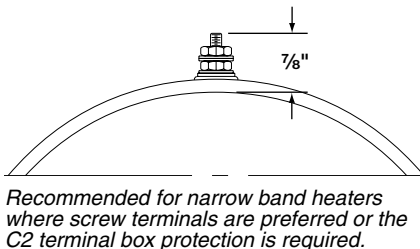

#### Two-Piece Band

**Standard Termination Location:** Next to same gap on each half; center of width

**Minimum Inside Diameter:** 50.8 mm (2")

**Minimum Width:** 22.2 mm (7/8")

**Post Terminals:** 10-32 standard except 8-32 on <1" wide heaters and heaters with ID <3"

**Maximum Volts/Amps:** 480 Vac/25 A (10-32) or 20 A (8-32) each half

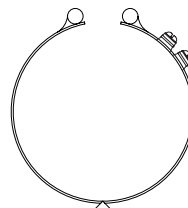

#### One-Piece Expandable Band

**Standard Termination Location:** Next to gap; center of width

**Minimum Inside Diameter:** 63.5 mm (2½")

**Minimum Width:** 31.8 mm (1¼")

**Post Terminals:** 10-32 standard except 8-32 on heaters with ID <3"

**Maximum Volts/Amps:** 480 Vac/25 A (10-32) or 20 A (8-32)

## Terminations

### Type T3-Screw Terminals

#### One-Piece Band

**Standard Termination Location:**

Next to gap; across center of width

**Minimum Inside Diameter:** 50.8 mm (2")

**Minimum Width:** 50.8 mm (2")

**Post Terminals:** 10-32 standard except 8-32 on 50.8 to 63.5 mm (2 to 2½") wide heaters and heaters with ID <3"

**Maximum Volts/Amps:** 480 Vac/25 A (10-32) or 20 A (8-32)

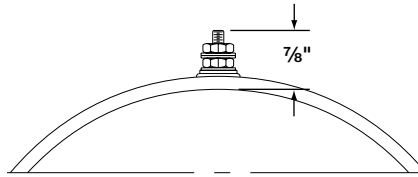

*The preferred design on band heaters over 76.2 mm (3") wide or when C3 terminal box is required.*

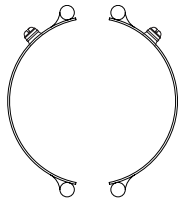

#### Two-Piece Band

**Standard Termination Location:**

Next to same gap on each half; across center of width

**Minimum Inside Diameter:** 50.8 mm (2")

**Minimum Width:** 50.8 mm (2")

**Post Terminals:** 10-32 standard except 8-32 on 50.8 to 63.5 mm (2 to 2½") wide heaters and heaters with ID <3"

**Maximum Volts/Amps:** 480 Vac/25 A (10-32) or 20 A (8-32) each half

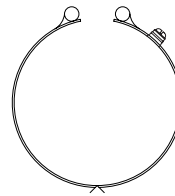

#### One-Piece Expandable Band

**Standard Termination Location:** Next to gap; across center of width

**Minimum Inside Diameter:** 63.5 mm (2½")

**Minimum Width:** 50.8 mm (2")

**Post Terminals:** 10-32 standard except 8-32 on 50.8 to 63.5 mm (2 to 2½") wide heaters and heaters with ID <3"

**Maximum Volts/Amps:** 480 Vac/25 A (10-32) or 20 A (8-32)

## Optional Igloo™ Ceramic Covers for Heaters with Screw Terminals

Igloo™ ceramic terminal covers consist of two individual ceramic parts. Unlike conventional ceramic caps, Igloo fully insulates any standard #8 or #10 terminal lugs used for electrical hook-ups.

### Limitations

To assemble Igloo covers, terminals should be at least 22 mm (7/8") apart

**Minimum ID:** 50.8 mm (2")

**Minimum Width:** 31.7 mm (1¼")

Three types of Igloo™ bases are available:

**Type C6**—Double Port In-Line model number: CER-101-104

**Type C7**—Double Port 90° model number: CER-101-106

**Type C8**—Single Port model number: CER-101-107

**Igloo™ Caps are Available in the Following Three Screw Terminal Sizes:**

**10-32**—model number: CER-102-101

**10-24**—model number: CER-102-104

**8-32**—model number: CER-102-105

When ordering, specify the type of Igloo and the screw terminal size.

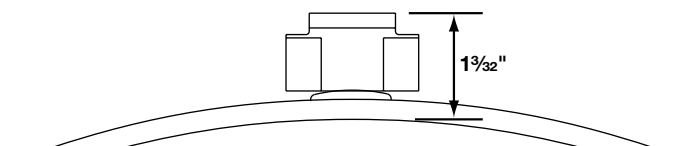
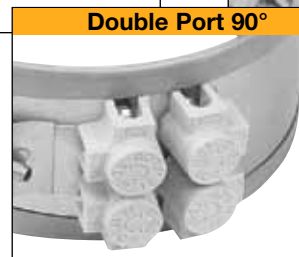
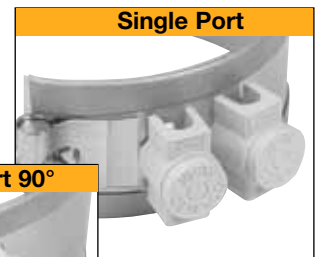
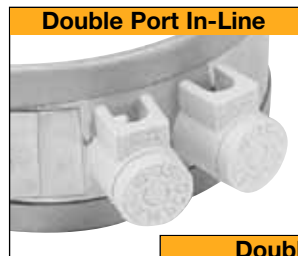

**CAUTION:** Exposed electrical wiring on band heater installations is a violation of Electrical Safety Codes including O.S.H.A.

## Terminations—Low-Profile Button Terminals: Type B1, Type B2 and Type B3

Available on any clamping or construction variation, the specially designed stainless steel button terminals are internally connected to the heater and are resistant to

over-torquing while offering a low profile for tight spaces. They are virtually unbreakable. Secure tightening of the electrical connections is essential for safety and long heater life.

### Type B1—Button Terminals

#### One-Piece Band

**Standard Termination Location:** Each side of gap; center of width

**Minimum Inside Diameter:** 50.8 mm (2")

**Minimum Width:** 38.1 mm (1½")

**Screw Size:** 10-32 standard except 6-32 on IDs <5"

**Maximum Volts:** 480 Vac

**Maximum Amps:** 25 A (10-32) or 20 A (6-32)

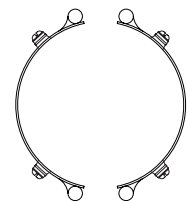
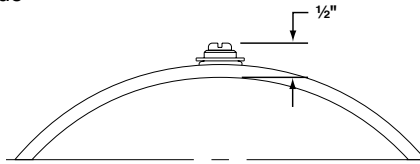

#### Two-Piece Band

**Standard Termination Location:** Next to gaps on each half; center of width

**Minimum Inside Diameter:** 50.8 mm (2")

**Minimum Width:** 38.1 mm (1½")

**Screw Size:** 10-32 standard except 6-32 on IDs <5"

**Maximum Volts/Amps:** 480 Vac/25 A (10-32) or 20 A (6-32) each half

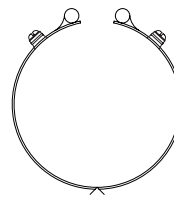

#### One-Piece Expandable Band

**Standard Termination Location:** Each side of gap; center of width

**Minimum Inside Diameter:** 63.5 mm (2½")

**Minimum Width:** 38.1 mm (1½")

**Screw Size:** 10-32 standard except 6-32 on IDs <5"

**Maximum Volts/Amps:** 480 Vac/25 A (10-32) or 20 A (6-32)

### Type B2—Button Terminals

#### One-Piece Band

**Standard Termination Location:** Next to gap; center of width

**Minimum Inside Diameter:** 50.8 mm (2")

**Minimum Width:** 38.1 mm (1½")

**Screw Size:** 10-32 standard except 6-32 on IDs <5"

**Maximum Volts:** 480 Vac

**Maximum Amps:** 25 A (10-32) or 20 A (6-32)

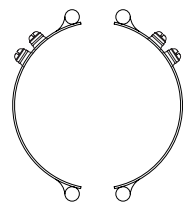

#### Two-Piece Band

**Standard Termination Location:** Next to same gap on each half; center of width

**Minimum Inside Diameter:** 50.8 mm (2")

**Minimum Width:** 38.1 mm (1½")

**Screw Size:** 10-32 standard except 6-32 On IDs <5"

**Maximum Volts/Amps:** 480 Vac/25 A (10-32) or 20 A (6-32) each half

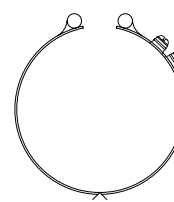

#### One-Piece Expandable Band

**Standard Termination Location:** Next to gap; center of width

**Minimum Inside Diameter:** 63.5 mm (2½")

**Minimum Width:** 38.1 mm (1½")

**Screw Size:** 10-32 standard except 6-32 on IDs <5"

**Maximum Volts/Amps:** 480 Vac/25 A (10-32) or 20 A (6-32)

## Type B3-Button Terminals

### One-Piece Band

**Standard Termination Location:** Next to gap; across center of width

**Minimum Inside Diameter:** 50.8 mm (2")

**Minimum Width:** 60.3 mm (2<sup>3</sup>/<sub>8</sub>")

**Screw Size:** 10-32 standard except 6-32 on IDs <5"

**Maximum Volts:** 480 Vac

**Maximum Amps:** 25 A (10-32) or 20 A (6-32)

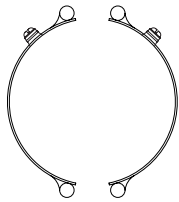
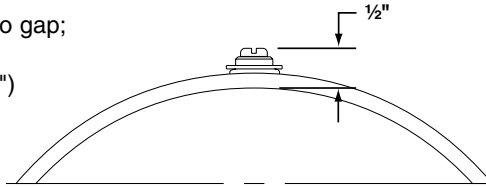

### Two-Piece Band

**Standard Termination Location:** Next to same gap on each half; across center of width

**Minimum Inside Diameter:** 50.8 mm (2")

**Minimum Width:** 60.3 mm (2<sup>3</sup>/<sub>8</sub>")

**Screw Size:** 10-32 standard except 6-32 on IDs <5"

**Maximum Volts/Amps:** 480 Vac/25 A (10-32) or 20 A (6-32) each half

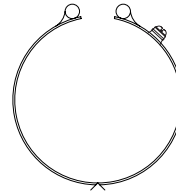

### One-Piece Expandable Band

**Standard Termination Location:** Next to gap; across center of width

**Minimum Inside Diameter:** 63.5 mm (2<sup>1</sup>/<sub>2</sub>")

**Minimum Width:** 60.3 mm (2<sup>3</sup>/<sub>8</sub>")

**Screw Size:** 10-32 standard except 6-32 On IDs <5"

**Maximum Volts/Amps:** 480 Vac/25 A (10-32) or 20 A (6-32)

## Plain Lead Wire Terminations: Type L1, Type L2 and Type L4 Available on Any Clamping or Construction Variation

### Type L1-Straight Lead Wires

The lead wires exit through a brass eyelet. The standard flexible leads are 254 (10") long with 76 (3") of fiberglass sleeving.

**Note:** If longer leads are required, specify when ordering.

### One-Piece Band

**Standard Termination Location:** Next to gap; center of width

**Minimum Inside Diameter:** 50.8 mm (2")

**Minimum Width:** 25.4 mm (1")

**Maximum Volts:** 480 Vac

**Maximum Amps:** 10 A

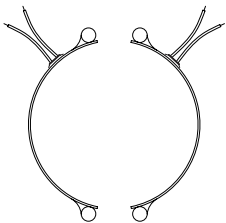

### Two-Piece Band

**Standard Termination Location:** Next to same gap on each half; center of width

**Minimum Inside Diameter:** 50.8 mm (2")

**Minimum Width:** 25.4 mm (1")

**Maximum Volts:** 480V each half

**Maximum Amps:** 10 A each half

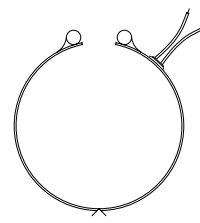

### One-Piece Expandable Band

**Standard Termination Location:** Next to gap; center of width

**Minimum Inside Diameter:** 63.5 mm (2<sup>1</sup>/<sub>2</sub>")

**Minimum Width:** 31.8 mm (1<sup>1</sup>/<sub>4</sub>")

**Maximum Volts:** 480V

**Maximum Amps:** 10 A

## Terminations

### Type L2—Straight Lead Wires

Type L2 is the preferred termination on all small diameter and small width band heaters. The standard flexible leads are 254 mm (10") long with 76 mm (3") of fiberglass sleeving.

*Note: If longer leads are required, specify when ordering.*

#### One-Piece Band

**Standard Termination Location:** Each side of gap; edge of width

**Minimum Inside Diameter:** 22.2 mm ( $\frac{7}{8}$ " )

**Minimum Width:** 19.1 mm ( $\frac{3}{4}$ " )

**Maximum Volts:** 480 Vac

**Maximum Amps:** 10 A

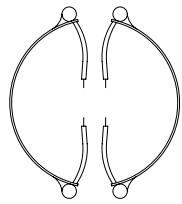

#### Two-Piece Band

**Standard Termination Location:** Each side of each gap; edge of width

**Minimum Inside Diameter:** 50.8 mm (2" )

**Minimum Width:** 19.1 mm ( $\frac{3}{4}$ " )

**Maximum Volts:** 480V each half

**Maximum Amps:** 10 A each half

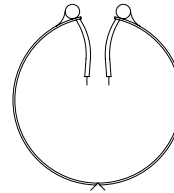

#### One-Piece Expandable Band

**Standard Termination Location:** Each side of gap; edge of width

**Minimum Inside Diameter:** 63.5 mm ( $2\frac{1}{2}$ " )

**Minimum Width:** 31.8 mm ( $1\frac{1}{4}$ " )

**Maximum Volts:** 480V

**Maximum Amps:** 10 A

### Type L4—Straight Lead Wires

Type L4 is a suitable lead termination for small band heaters. The standard flexible leads are 254 mm (10") long with 76 mm (3") of fiberglass sleeving.

*Note: If longer leads are required, specify when ordering.*

#### One-Piece Band

**Standard Termination Location:** Same side of gap; edge of width

**Minimum Inside Diameter:** 22.2 mm ( $\frac{7}{8}$ " )

**Minimum Width:** 25.4 mm (1" )

**Maximum Volts:** 480 Vac

**Maximum Amps:** 10 A

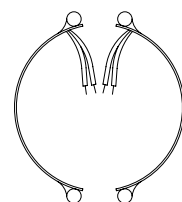

#### Two-Piece Band

**Standard Termination Location:** Each side of same gap; center of width

**Minimum Inside Diameter:** 50.8 mm (2" )

**Minimum Width:** 25.4 mm (1" )

**Maximum Volts:** 480V each half

**Maximum Amps:** 10 A each half

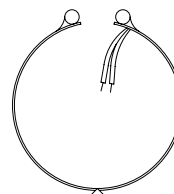

#### One-Piece Expandable Band

**Standard Termination Location:** Same side of gap; edge of width

**Minimum Inside Diameter:** 63.5 mm ( $2\frac{1}{2}$ " )

**Minimum Width:** 31.8 mm ( $1\frac{1}{4}$ " )

**Maximum Volts:** 480 Vac

**Maximum Amps:** 10 A

## Abrasion Resistant Lead Terminations: Type W1, Type W2, Type W2M, Type W3, Type W4 and Type W5M

### Type W1—Straight Wire Braid Leads

Available on any clamping or construction variation. Wire braid leads offer sharp bending not possible with armor cable.

The standard leads are 254 mm (10") of wire braid over 305 mm (12") of flexible leads.

**Note:** If longer leads are required, specify when ordering.



#### One-Piece Band

##### Standard Termination Location:

Next to gap; center of width

**Minimum Inside Diameter:** 50.8 mm (2")

**Minimum Width:** 25.4 mm (1")

**Maximum Volts:** 480 Vac

**Maximum Amps:** 10 A

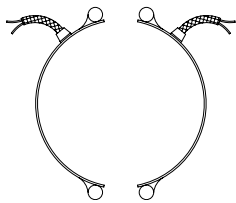
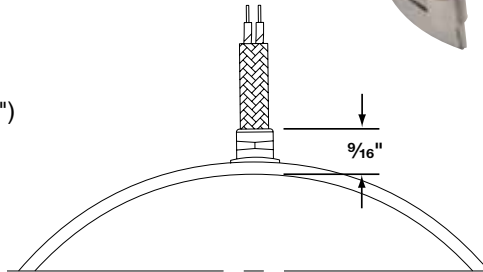

#### Two-Piece Band

**Standard Termination Location:**  
Next to same gap on each half;  
center of width

**Minimum Inside Diameter:**  
50.8 mm (2")

**Minimum Width:** 25.4 mm (1")

**Maximum Volts:** 480 Vac each half

**Maximum Amps:** 10 A each half

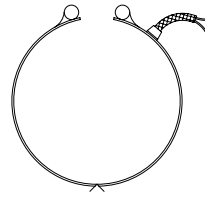

#### One-Piece Expandable Band

**Standard Termination Location:**  
Next to gap; center of width

**Minimum Inside Diameter:**  
63.5 mm (2½")

**Minimum Width:** 31.8 mm (1¼")

**Maximum Volts:** 480 Vac

**Maximum Amps:** 10 A

### Type W2—Wire Braid Leads

The W2 wire braid exits at 180° from the gap for special nozzle heating applications. Sleeving is used for additional protection. The standard leads are 254 mm (10") of wire braid over 305 mm (12") of flexible leads with 76 mm (3") of fiberglass sleeving.

**Note:** If longer leads are required, specify when ordering.

Type W2 is not available on two-piece or one-piece expandable Duraband heaters.

#### One-Piece Band

##### Standard Termination Location:

Opposite the gap; edge of width

**Minimum Inside Diameter:** 22.2 mm (7/8")

**Minimum Width:** 28.6 mm (1⅛")

**Maximum Volts:** 480 Vac

**Maximum Amps:** 10 A

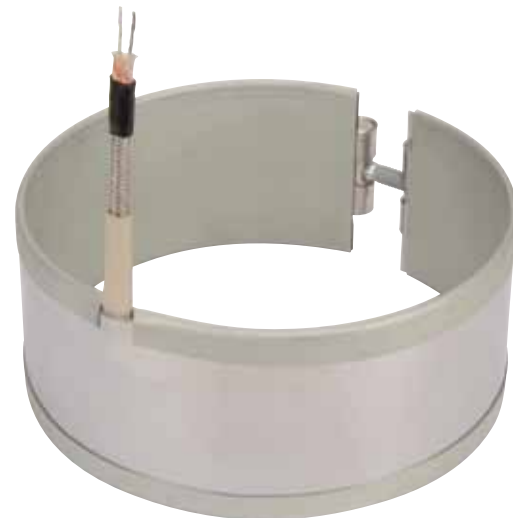

## Terminations

### Type W3—Single Wire Braid Leads

Highly recommended for nozzle heating applications. The standard leads are 254 mm (10") of wire braid over 305 mm (12") of flexible leads with 76 mm (3") of fiber glass sleeving.

**Note:** If longer leads are required, specify when ordering.



#### One-Piece Band

**Standard Termination Location:** Each side of gap; edge of width

**Minimum Inside Diameter:** 19.1 mm (¾")

**Minimum Width:** 22.2 mm (7/8")

**Maximum Volts:** 480 Vac

**Maximum Amps:** 10 A

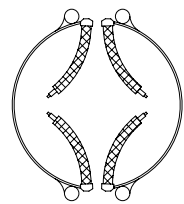

#### Two-Piece Band

**Standard Termination Location:** Each side of each gap; edge of width

**Minimum Inside Diameter:** 50.8 mm (2")

**Minimum Width:** 19.1 mm (¾")

**Maximum Volts:** 480 Vac each half

**Maximum Amps:** 10 A each half

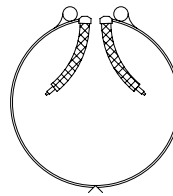

#### One-Piece Expandable Band

**Standard Termination Location:** Each side of gap; edge of width

**Minimum Inside Diameter:** 19.0 mm (2½")

**Minimum Width:** 31.8 mm (1¼")

**Maximum Volts:** 480 Vac

**Maximum Amps:** 10 A

### Type W4—Wire Braid Leads on One Side

A suitable termination for nozzle heating applications. The standard leads are 254 mm (10") of wire braid over 305 mm (12") of flexible leads.

**Note:** If longer leads are required, specify when ordering.



#### One-Piece Band

**Standard Termination Location:** Next to gap; edge of width

**Minimum Inside Diameter:** 22.2 mm (7/8")

**Minimum Width:** 25.4 mm (1")

**Maximum Volts:** 480 Vac

**Maximum Amps:** 10 A

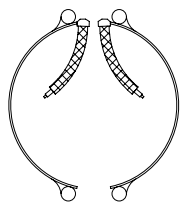

#### Two-Piece Band

**Standard Termination Location:** Next to same gap on each half; edge of width

**Minimum Inside Diameter:** 50.8 mm (2")

**Minimum Width:** 25.4 mm (1")

**Maximum Volts:** 480 Vac each half

**Maximum Amps:** 10 A each half

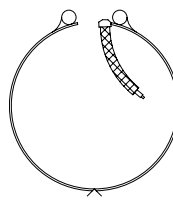

#### One-Piece Expandable Band

**Standard Termination Location:** Next to gap; edge of width

**Minimum Inside Diameter:** 63.5 mm (2½")

**Minimum Width:** 31.8 mm (1¼")

**Maximum Volts:** 480 Vac

**Maximum Amps:** 10 A

## Type W2M—Right-Angle Wire Braid Leads, 90° to Heater

Stainless steel wire braid exits perpendicular to the heater centerline through a low profile stainless steel cap. This cap acts as a strain relief which protects against excessive flexing or pulling of the lead wire. The standard leads are 254 mm (10") of wire braid over 305 mm (12") of flexible leads.

**Note:** If longer leads are required, specify when ordering. Stainless steel construction may be required for widths of 22.2 mm (7/8") to 41.3 mm (1 5/8").



### One-Piece Band

**Standard Termination Location:** Opposite of gap; center of width

**Minimum Inside Diameter:** 38.1 mm (1 1/2")

**Minimum Width:** 31.8 mm (1 1/4")

**Maximum Volts:** 480 Vac

**Maximum Amps:** 10 A



### Two-Piece Band

**Standard Termination Location:** Next to same gap on each half; center of width

**Minimum Inside Diameter:** 50.8 mm (2")

**Minimum Width:** 31.8 mm (1 1/4")

**Maximum Volts:** 480 Vac each half

**Maximum Amps:** 10 A each half



### One-Piece Expandable Band

**Standard Termination Location:** Next to gap; center of width

**Minimum Inside Diameter:** 63.5 mm (2 1/2")

**Minimum Width:** 31.8 mm (1 1/4")

**Maximum Volts:** 480 Vac

**Maximum Amps:** 10 A

## Type W5M—Right-Angle Wire Braid Leads, Parallel to Heater

Stainless steel wire braid exits parallel to the heater centerline through a low profile stainless steel cap. This cap acts as a strain relief which protects against excessive flexing or pulling of the lead wire. The standard leads are 254 mm (10") of wire braid over 305 mm (12") of flexible leads.

**Note:** If longer leads are required, specify when ordering. Stainless steel construction may be required for widths of 22.2 mm (7/8") to 41.3 mm (1 5/8").



### One-Piece Band

**Standard Termination Location:** Opposite of gap; center of width

**Minimum Inside Diameter:** 38.1 mm (1 1/2")

**Minimum Width:** 31.8 mm (1 1/4")

**Maximum Volts:** 480 Vac

**Maximum Amps:** 10 A

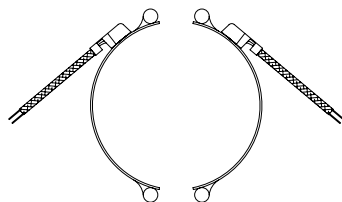

### Two-Piece Band

**Standard Termination Location:** Next to same gap on each side; center of width

**Minimum Inside Diameter:** 50.8 mm (2")

**Minimum Width:** 31.8 mm (1 1/4")

**Maximum Volts:** 480 Vac each half

**Maximum Amps:** 10 A each half

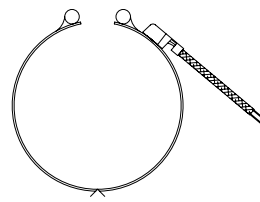

### One-Piece Expandable Band

**Standard Termination Location:** Next to gap; center of width

**Minimum Inside Diameter:** 63.5 mm (2 1/2")

**Minimum Width:** 31.8 mm (1 1/4")

**Maximum Volts:** 480 Vac

**Maximum Amps:** 10 A



## Terminations—Armor Cable Terminations: Type R1, Type R2 and Type R3

Available on any clamping or construction variation. Armor cable provides far superior protection to lead wires where

abrasion is a constant problem. The standard leads are 254 mm (10") of armor cable over 305 mm (12") of flexible leads.

*Note: If longer leads are required, specify when ordering.*

### Type R1 – Straight Armor Cable

- Type R1A—Galvanized armor cable, crimped
- Type R1B—Stainless Steel armor cable, crimped
- Type R1C—Galvanized armor cable, tack welded

- Type R1D—Stainless Steel armor cable, tack welded
- Type R1E—Galvanized armor cable, full silver brazing
- Type R1F—Stainless Steel armor cable, full silver brazing

#### One-Piece Band

##### Standard Termination Location:

Next to gap; center of width

**Minimum Inside Diameter:** 38.1 mm (1½")

**Minimum Width:** 25.4 mm (1")

**Maximum Volts:** 480 Vac

**Maximum Amps:** 10 A

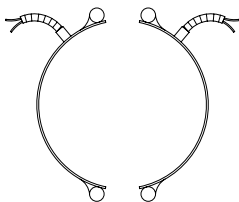
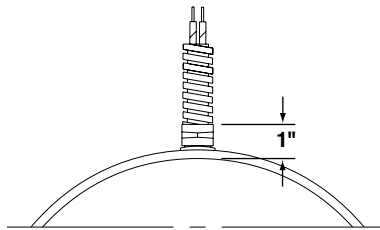

#### Two-Piece Band

##### Standard Termination Location:

Next to same gap on each half; center of width

**Minimum Inside Diameter:** 50.8 mm (2")

**Minimum Width:** 25.4 mm (1")

**Maximum Volts/Amps:** 480 Vac/10 A each half

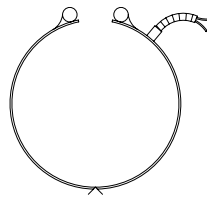

#### One-Piece Expandable Band

##### Standard Termination Location:

Next to gap; center of width

**Minimum Inside Diameter:** 65.3 mm (2½")

**Minimum Width:** 31.8 mm (1¼")

**Maximum Volts/Amps:** 480 Vac/10 A

### Type R2—Right-Angle Armor Cable

- Type R2A—Galvanized armor cable, crimped
- Type R2B—Stainless Steel armor cable, crimped
- Type R2C—Plain leads, no cable

#### One-Piece Band

##### Standard Termination Location:

Next to gap; center of width

**Minimum Inside Diameter:** 38.1 mm (1½")

**Minimum Width:** 31.8 mm (1¼")

**Maximum Volts:** 480 Vac

**Maximum Amps:** 10 A

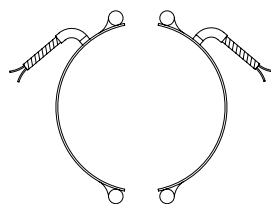
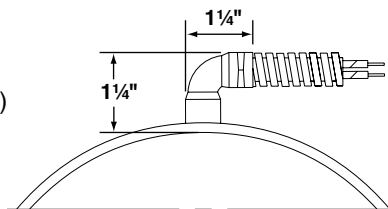

#### Two-Piece Band

##### Standard Termination Location:

Next to same gap on each half; center of width

**Minimum Inside Diameter:** 50.8 mm (2")

**Minimum Width:** 31.8 mm (1¼")

**Maximum Volts/Amps:** 480 Vac/10 A each half

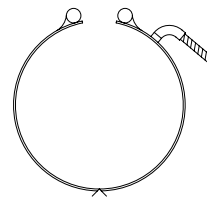

#### One-Piece Expandable Band

##### Standard Termination Location:

Next to gap; center of width

**Minimum Inside Diameter:** 63.5 mm (2½")

**Minimum Width:** 31.8 mm (1¼")

**Maximum Volts/Amps:** 480 Vac/10 A

## Type R3—Removable Armor Cable

**Type R3A**—Plain leads and female fitting

**Type R3B**—Leads, male adaptor and galvanized armor

**Type R3C**—Leads, male adaptor and stainless steel armor

Recommended on applications where removable armor is required. The fitting will accept the standard armor cable connector. The standard leads are 254 mm (10") of armor cable over 305 mm (12") of flexible leads.

*Note: If longer leads are required, specify when ordering.*

### One-Piece Band

**Standard Termination Location:** Next to gap; center of width

**Minimum Inside Diameter:** 38.1 mm (1½")

**Minimum Width:** 31.7 mm (1¼")

**Maximum Volts/Amps:** 480 Vac/10 A

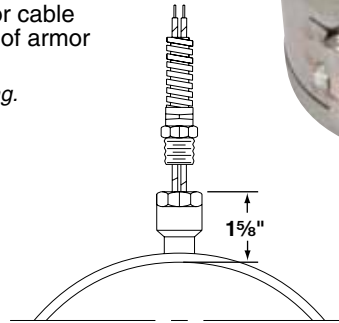

Type R3B shown

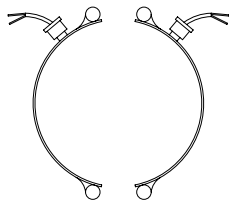

### Two-Piece Band

**Standard Termination Location:** Next to same gap on each half; center of width

**Minimum Inside Diameter:** 50.8 mm (2")

**Minimum Width:** 31.7 mm (1¼")

**Maximum Volts/Amps:** 480 Vac/10 A each half

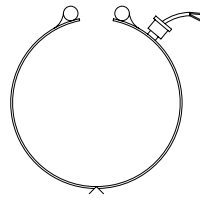

### One-Piece Expandable Band

**Standard Termination Location:** Next to gap; center of width

**Minimum Inside Diameter:** 63.5 mm (2½")

**Minimum Width:** 31.8 mm (1¼")

**Maximum Volts/Amps:** 480 Vac/10 A

## Type S1—Lead Wire Spring Strain Relief

**Type S1A**—Plain leads and strain relief spring

**Type S1B**—Stainless steel wire braided leads and strain relief spring. 254 mm (10") of braid over 305 mm (12") of flexible leads is standard.

A strain relief spring is attached to the heater at the termination exit to reduce strain on leads subjected to excessive flexing. The spring is 54 mm (2½") long. The flexible standard leads are 254 mm (10") long with 76 mm (3") of fiberglass sleeving.

*Note: If longer leads are required, specify when ordering.*

### One-Piece Band

**Standard Termination Location:** Next to gap; center of width

**Minimum Inside Diameter:** 50.8 mm (2")

**Minimum Width:** 31.8 mm (1¼")

**Maximum Volts:** 480 Vac

**Maximum Amps:** 10 A

Type S1B shown

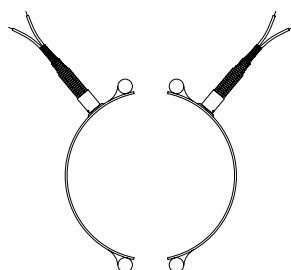

### Two-Piece Band

**Standard Termination Location:** Next to same gap on each half; center of width

**Minimum Inside Diameter:** 50.8 mm (2")

**Minimum Width:** 31.75 mm (1¼")

**Maximum Volts/Amps:** 480 Vac/10 A each half

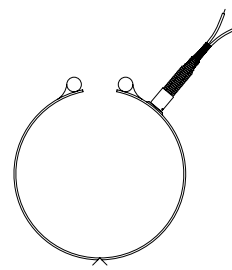

### One-Piece Expandable Band

**Standard Termination Location:** Next to gap; center of width

**Minimum Inside Diameter:** 63.5 mm (2½")

**Minimum Width:** 31.75 mm (1¼")

**Maximum Volts/Amps:** 480 Vac/10 A

## Terminations—General Purpose Terminal Boxes: Type C2 and Type C5

Available with any construction or clamping variation. They are a simple and economical way to protect employees from electric shock or prevent electric shorts that can result from exposed wiring on band heater electrical installations.

The heavy duty terminal boxes have 13 mm (1/2") knockouts that will accept standard armor cable connectors. They can be field assembled on band heaters that have a center

distance between terminal screws of 22 mm (7/8"). Boxes can be pre-wired with galvanized armor, stainless steel armor, wire braid or plain leads. If a low profile box with cable or leads is required, it is strongly recommended to order it pre-wired by the factory.

The standard leads are 254 mm (10") of cable or wire braid over 305 mm (12") of flexible leads. If longer leads are required, specify when ordering.

### Type C2—Terminal Boxes

#### Type C2—Standard Box

**C2A**—Box only

**C2B**—with galvanized armor

**C2C**—with stainless steel armor

**C2D**—with wire braid

#### One-Piece Band

##### Standard Termination Location:

Next to gap; center of width

**Minimum Inside Diameter:** 63.5 mm (2 1/2")

**Minimum Width:** 25.4 mm (1")

**Maximum Volts/Amps:** 480 Vac/25 A

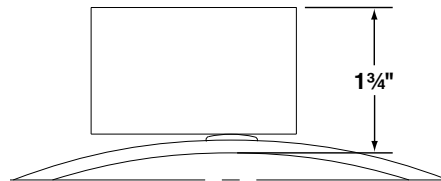

Type C2 shown

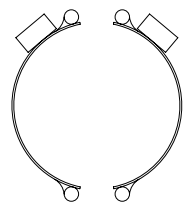

#### Two-Piece Band

**Standard Termination Location:** Next to same gap on each half; center of width

**Minimum Inside Diameter:** 76.2 mm (3")

**Minimum Width:** 25.4 mm (1")

**Maximum Volts/Amps:** 480 Vac/25 A each half

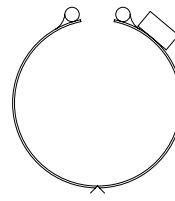

#### One-Piece Expandable Band

**Standard Termination Location:** Next to gap; center of width

**Minimum Inside Diameter:** 63.5 mm (2 1/2")

**Minimum Width:** 25.4 mm (1")

**Maximum Volts/Amps:** 480 Vac/25 A

Heater widths between 25 and 64 mm (1 and 2 1/2") require a minimum ID of 140 mm (5 1/2") or greater.

### Type C5—Terminal Boxes

#### Type C5—Low Profile Box

**C5A**—Box only

**C5B**—with galvanized armor

**C5C**—with stainless steel armor

**C5D**—with wire braid

**C5J**—with plain leads

#### One-Piece Band

**Standard Termination Location:** Next to gap; center of width

**Minimum Inside Diameter:** 63.5 mm (2 1/2")

**Minimum Width:** 25.4 mm (1")

**Maximum Volts/Amps:** 480 Vac/25 A

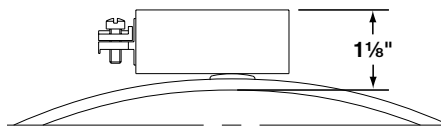

Type C5 shown

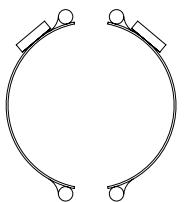

#### Two-Piece Band

**Standard Termination Location:** Next to same gap on each half; center of width

**Minimum Inside Diameter:** 76.2 mm (3")

**Minimum Width:** 25.4 mm (1")

**Maximum Volts/Amps:** 480 Vac/25 A each half

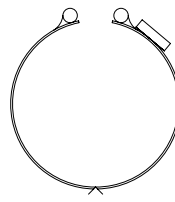

#### One-Piece Expandable Band

**Standard Termination Location:** Next to gap; center of width

**Minimum Inside Diameter:** 63.5 mm (2 1/2")

**Minimum Width:** 25.4 mm (1")

**Maximum Volts/Amps:** 480 Vac/25 A

## Quick Disconnect Plugs: Type P1, Type P2, Type P3 and Type P4

Available on any construction or clamping variation. These plug assemblies are highly recommended and should be used whenever possible. The combination of plug and cup assembly along with armor cable covered leads eliminates all live exposed terminals or wiring that can be a potential hazard to employees or machinery.

Type P1 and P3 assemblies are available with a straight or right-angle plug. Type P2 and P4 plug assemblies have a lower profile and are available with a straight plug only.

To simplify installation, band heaters with these assemblies can be supplied pre-wired, using high temperature lead wires.

The standard leads are 254 mm (10") of armor cable over (12") of flexible leads. If longer leads are required, specify when ordering.

### Type P1—High Temperature Quick Disconnect Plugs

#### Type P1

**P1K**—Cup assembly only

**P1L**—with straight plug

**P1M**—with 90° plug only

**P1N**—with straight plug and galvanized cable

**P1O**—with straight plug and stainless steel cable

**P1P**—with straight plug and wire braid

**P1Q**—with 90° plug and galvanized cable

**P1R**—with 90° plug and stainless steel cable

**P1S**—with 90° plug and wire braid



Type P1Q shown

#### One-Piece Band

**Standard Termination Location:** Next to gap; center of width

**Minimum Inside Diameter:** 50.8 mm (2")

**Minimum Width:** 38.1 mm (1½")

#### Plug Electrical Ratings

**2-Pole 3-Wire Grounding**

**Maximum Volts:** 250 Vac

**Maximum Amps:** 16 A

**Maximum Temperature:** 300°C (572°F)

If width is between 38 and 51 mm (1½ and 2"), minimum diameter is 140 mm (5½"). If width is greater than 64 mm (2"), minimum diameter is 64 mm (2")

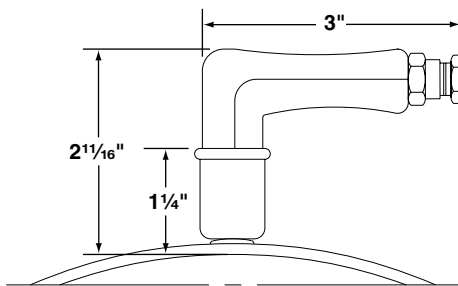

Type P1M

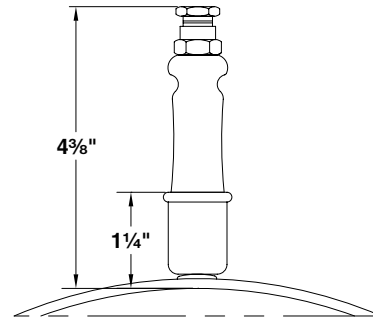

Type P1L

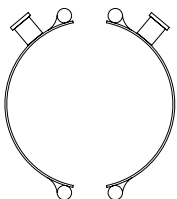

#### Two-Piece Band

**Standard Termination Location:** Next to same gap on each half; center of width

**Minimum Inside Diameter:** 50.8 mm (2")

**Minimum Width:** 38.1 mm (1½")

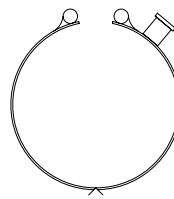

#### One-Piece Expandable Band

**Standard Termination Location:** Next to gap; center of width

**Minimum Inside Diameter:** 63.5 mm (2½")

**Minimum Width:** 38.1 mm (1½")

## Terminations

### Type P2—High Temperature Quick Disconnect Plugs

**Type P2—Low Profile Assembly**

**P2F**—Low profile assembly only

**P2G**—with straight plug only

**P2H**—with straight plug and galvanized cable

**P2J**—with straight plug and stainless steel cable

**P2K**—with straight plug and wire braid

#### One-Piece Band

**Standard Termination Location:**

Next to gap; center of width

**Minimum Inside Diameter:** 76.2 mm (3")

**Minimum Width:** 63.5 mm (2½")

#### Plug Electrical Ratings

**2-Pole 3-Wire Grounding**

**Maximum Volts:** 250 Vac

**Maximum Amps:** 16 A

**Maximum Temperature:** 300°C (572°F)

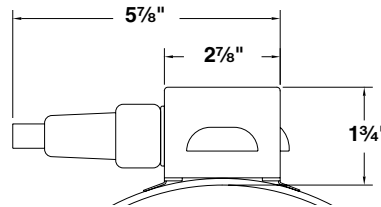

Type P2G shown



Type P2H shown

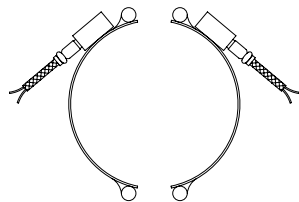

#### Two-Piece Band

**Standard Termination Location:**

Next to same gap on each half; center of width

**Minimum Inside Diameter:**

76.2 mm (3")

**Minimum Width:** 63.5 mm (2½")

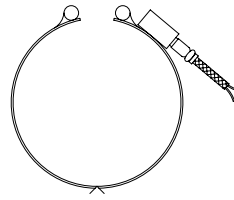

#### One-Piece Expandable Band

**Standard Termination Location:**

Next to gap; center of width

**Minimum Inside Diameter:**

76.2 mm (3")

**Minimum Width:** 63.5 mm (2½")

### Type P3—DIN 49458 A/B Quick Disconnect Plugs

**Type P3—Vertical Box Assembly**

**P3A**—Box assembly only

**P3B**—Box assembly with straight plug

**P3C**—Box assembly with right-angle plug only

#### One-Piece Band

**Standard Termination Location:** Next to gap; center of width

**Minimum Inside Diameter:** 76.2 mm (3")

**Minimum Width:** 38.1 mm (1½")

#### Plug Electrical Ratings

**2-Pole 3-Wire Grounding**

**Maximum Volts:** 250 Vac

**Maximum Amps:** 16 A

**Maximum Temperature:** 200°C (392°F)

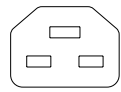

Standard pin orientation

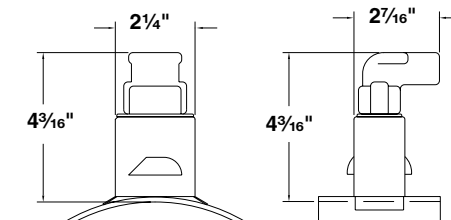

Type P3C shown

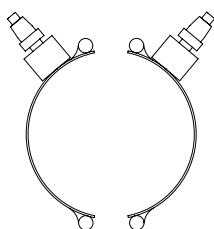

#### Two-Piece Band

**Standard Termination Location:**

Next to same gap on each half; center of width

**Minimum Inside Diameter:**

76.2 mm (3")

**Minimum Width:** 38.1 mm (1½")

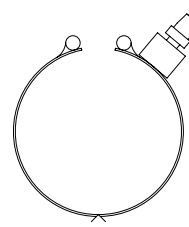

#### One-Piece Expandable Band

**Standard Termination Location:**

Next to gap; center of width

**Minimum Inside Diameter:**

76.2 mm (3")

**Minimum Width:** 38.1 mm (1½")

## Type P4—DIN 49458 A/B Quick Disconnect Plugs

### Type P4—Horizontal Box Assembly

P4A—Box assembly only

P4B—Box assembly with straight plug

### One-Piece Band

**Standard Termination Location:** Next to gap; center of width

**Minimum Inside Diameter:** 76.2 mm (3")

**Minimum Width:** 63.5 mm (2½")

### Plug Electrical Ratings

**2-Pole 3-Wire Grounding**

**Maximum Volts:** 250 Vac

**Maximum Amps:** 16 A

**Maximum Temperature:** 200°C (392°F)

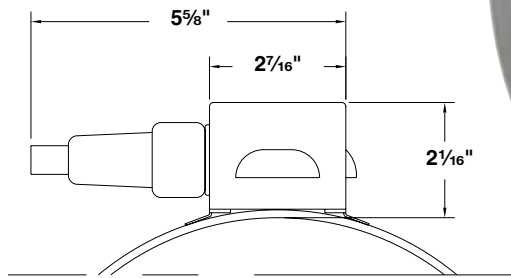

Standard pin orientation

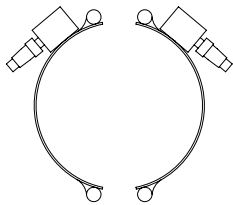

### Two-Piece Band

**Standard Termination Location:** Next to same gap on each half; center of width

**Minimum Inside Diameter:** 76.2 mm (3")

**Minimum Width:** 63.5 mm (2½")

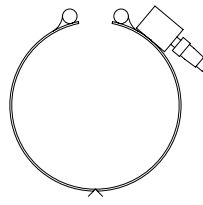

### One-Piece Expandable Band

**Standard Termination Location:** Next to gap; center of width

**Minimum Inside Diameter:** 63.5 mm (2½")

**Minimum Width:** 76.2 mm (3")

## Special Duraband® Construction Options and Variations

### Thermocouple Bayonet Adaptor

A standard bayonet adaptor facilitates the installation of an external thermocouple with a standard bayonet cap. The standard location for the adaptor is 90° from the gap.

Specify without through hole for heater sensing or with through hole for load sensing. For heaters less than 25 mm (1") wide order separate strap clamping and utilize the gap for the thermocouple.

Visit [omega.com](http://omega.com) for a complete selection of thermocouples.

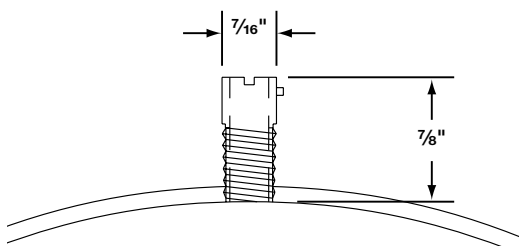

## Construction Options and Variations

### Thermocouple Coupling

The thermocouple coupling facilitates the installation of an external thermocouple with a threaded fitting to sense the temperature of the band. The standard location for the coupling is 90° from the gap. Specify without through hole for heater sensing or with through hole for load sensing.



### Available Bushing Sizes

Thread	D, mm (inch)	H, mm (inch)
1/8-27 NPT	14.2 (9/16)	15.8 (5/8)
1/4-20 NPT	19 (3/4)	17.4 (1 1/16)
3/8-18 NPT	22.2 (7/8)	15.8 (5/8)
M12-1.75 mm	19 (3/4)	12.7 (1/2)

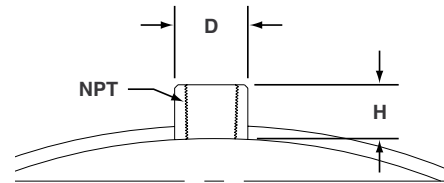

### Holes and Cutouts

Holes and cutouts are normally required in band heaters for clearance for thermocouple probes or holding bolts. An oversize gap can in many cases serve the same purpose, saving the expense of the hole.

Using the center of the gap as a starting point, specify the location of the centerpoint of the hole or cutout in terms of degrees and the distance from the edge of the heater. In addition, state the size of the hole or cutout.

For critical hole and cutout locations, a detailed drawing will be required.

**Note:** A minimum of 13 mm (1/2") is required from the hole to the edge of the heater.



### Hinged Two-Piece Band

The hinged two-piece band heater is connected with a continuous hinge for easy installation and removal. This heater can be opened and closed as often as is necessary. The preferred method of clamping is latch and trunnion. It is available with any screw or lead variation. When ordering, specify watts and volts each half.

**Minimum Width:** 34.9 mm (1 3/8")



## Special Mica Insulated Heater Construction Variations

### Ring Heaters

When ordering ring heaters, specify inside and outside diameters. If mounting holes are required, specify location and hole size. For critical hole and cutout locations, a detailed drawing will be required.

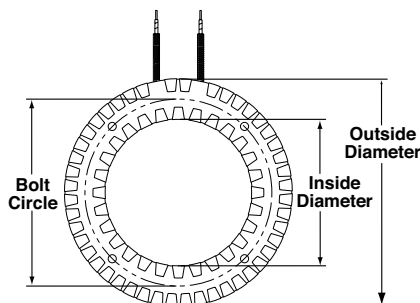

## Duraband Features

### Additional Duraband® Heater Features

#### Electrical Variations

##### Three-Phase

On very high wattage band heaters it would be advantageous to set up the wiring three-phase to reduce the current load across a single conductor. Three-phase wiring is available on select clamping/construction or termination variation (termination location is subject to engineering approval).

**Minimum ID:** 76.2 mm (3"), **Minimum Width:** 50.8 mm (2")

##### Dual Voltage

Band heaters can be designed using 3-wire series/parallel circuits for dual voltage applications. Whether the heater is run on the higher or lower voltage, the wattage will be the same. Dual Voltage wiring is available on any clamping/construction or termination variation.

##### Ground Terminal or Lead

For those applications requiring a separate ground terminal or lead attached to the heater sheath. A ground terminal or lead is available on any clamping/construction or termination variation.

##### Single Phase/Three Phase Duraband

Heaters can be designed with multiple circuits to operate single or three-phase.

#### Lead Variations

##### Electrical Plugs

Industry standard NEMA Twist-Lock® electrical plugs are available. The plugs can be attached to fiberglass leads, armor cable or wire braid. Electrical plugs can be added to any clamping/construction or termination variation.

#### Built-In Thermocouples

Heaters can be manufactured with a built-in thermocouple to closely control the temperature of the heater.

Type J or K thermocouples are available with fiberglass, wire braid or any other required insulation. Contact OMEGA with your requirements.

#### Construction Variations

##### All Stainless Steel Construction

Mica band heaters can be constructed with the external sheath made entirely from stainless steel. This allows the Duraband to reach the maximum temperature of 650°C (1200°F). All stainless steel construction is available on any clamping/construction or termination variation.

##### Other Sheath Materials

Other sheath materials, such as rust-resistant steel, Monel®, aluminum, or copper are also available for unique applications.

#### Terminal Lugs

Various types of crimp terminals can be attached to the heater leads to make wiring into applications quick and easy. High temperature [649°C (1200°F)] ring terminals and nylon or PVC insulated terminals are available. Spade, ring, and right-angle or straight quick disconnect type terminals can be attached to the leads.



Plug Model No.	Receptacle Model No.	Reference	NEMA P or R	Amps	Volts
EHD-102-113	EHD-103-104	P4 twist lock	L5-15	15	125
EHD-102-121	EHD-103-107	P5 twist lock	L6-15	15	250
EHD-102-104	N/A	P9 twist lock	L2-20	20	250

#### Custom Engineered/Manufactured Heaters

Understanding that an electric heater can be very application specific, for sizes not listed OMEGA® will design and manufacture a Duraband Heater to meet your requirements.

#### Please Specify the Following:

- Inside Diameter
- Width
- Wattage
- Voltage
- Quantity
- Termination (see pages 9 through 22)
- Lead Cable/Braid Length
- Construction style (see pages 5, 22)
- Clamping variation (see pages 6 through 8)
- Special Features



## Installation Recommendations

### Installation Accessories Available

- High Temperature Terminal Lugs
- Igloo™ Ceramic Terminal Covers
- UI Listed Plugs
- High Temperature Lead Wire 450°C (842°F)
- Armor Cable
- Stainless Steel Braid

- High Temperature Sleeving
- Stainless Steel Barrel Covers
- High Temperature Mica Insulated Wiring Harnesses 450°C (842°F)
- Thermocouples
- Temperature Controllers
- High Temperature Fiberglass Tape

1. Disconnect electric power to the machine and/or heaters prior to installing or replacing heaters.
2. Do not install heaters in areas where combustible gases, vapor or dust is present.
3. Use as many narrow band heaters as the application will permit. 38 through 76 mm (1½ through 3") wide heaters are recommended.
4. Using a heater that closely matches the wattage requirements will decrease the frequency of cycling and temperature overshoot, thereby increasing the life of the heater.
5. Make certain that all barrel surfaces are clean and have a smooth finish. Any contaminants or imperfections on the surface can cause premature heater failure.
6. Expandable type Mica Band Heaters may be opened once at the gap to fit on the barrel. Do not open these heaters beyond their specified heater diameter.

**Caution:** Do not open one-piece non-expandable type mica band heaters. Opening of these heaters can damage Mica Insulation and will create electrical short circuits.

7. Position heater bands on the barrel.
8. Securely tighten heater bands around the barrel. Clamping force must be equally distributed on heaters with more than one set of clamping brackets. *Recommended clamping bolt torque is 10 ft./lbs.*
9. For heaters with screw terminals, remove the top nut and flat washers from the power screw terminals. Do not remove or loosen the bottom nut on the power screw terminals. The bottom nut is tightened to 60 in./lbs. at the factory. A loose bottom nut may cause premature heater failure.
10. All electrical wiring of heater bands should be done by a qualified electrician.
  - A. Use only Stainless Steel or other high temperature lugs to prevent material degradation when exposed to high temperatures over a prolonged period of time.
 

**Caution:** Do not use copper or plated copper lugs.
  - B. Use only lead wire with high temperature insulation and proper gauge size.

- C. When connecting power leads to screw terminals make certain that barrels of terminal lugs are not facing down toward the heater case, which will create a short circuit. *Tighten the top nut to 30 in./lbs.*
- D. Make certain power lead wires do not make contact with hot heater surface to avoid degradation of lead wire, as this can cause electrical short circuits.
- E. Make sure the voltage input to the heater bands does not exceed the voltage rating that is stamped on the heater band.
- F. It is recommended that an amperage reading is taken for each heater to verify proper wiring. *(Amps = Watts/Volts)*
11. Insulate all live electrical wires per applicable safety standards.
12. Begin heater band re-tightening procedure. Be sure to wear protective gloves.
  - A. Energize heater bands and allow the heater to reach 149°C (300°F). This usually takes between 3 and 5 minutes.
  - B. Turn off power and immediately re-tighten the heater bands to 10 ft./lbs. Turn power back on.
13. Install shrouds around the machine to meet applicable safety requirements.
14. Once installed, check surroundings to make sure that contaminants won't get on the heater while the unit is in operation. Accumulation of contaminants on heaters can cause premature heater failure.
15. Insulating blanket installations must have band heater re-tightening sequence (#12) completed before blanket installation. Lead wires must exit the insulation blanket as soon as possible; do not entrap lead wires between heater sheath and insulation blanket.
 

**Caution:** It is imperative that upon start-up of new machines at customer facilities, all of the aforementioned parameters are double checked by qualified field service personnel.

**CAUTION: Exposed electrical wiring on band heater installations is a violation of Electrical Safety Codes including O.S.H.A.**

## Nozzle Band Heaters

Standard Replacement Mica Insulated Band Heaters for Plastic Injection Molding Machines



To Order Visit <a href="http://omega.com/mbh_nozzle">omega.com/mbh_nozzle</a> for Pricing and Details						
Model Number		Inside Diameter		Width		Watt
120V	240V	mm	inch	mm	inch	
—	<b>MBH00033</b>	31.8	1¼	30.2	1⅜	125
<b>MBH00031</b>	<b>MBH00035</b>	38.1	1½	25.4	1	150
—	<b>MBH00036*</b>	38.1	1½	25.4	1	150
—	<b>MBH00038</b>	58.7	2⅝	36.5	1⅞	300
—	<b>MBH00039*</b>	58.7	2⅝	36.5	1⅞	300

\* Heaters have built-in Type J thermocouple.

Ordering Example: MBH00031, 120V, 150 watt, nozzle band heater.

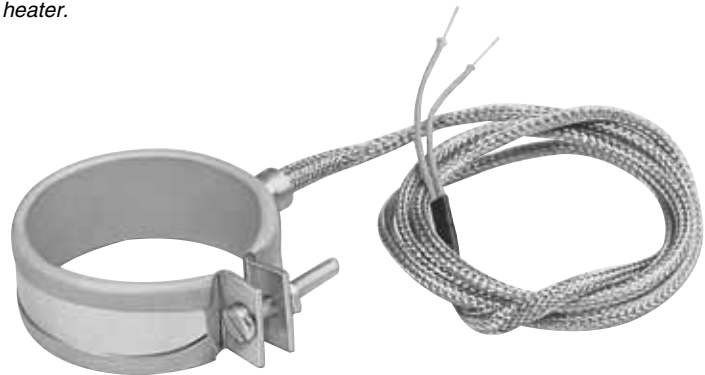

To Order Visit <a href="http://omega.com/mbh_nozzle">omega.com/mbh_nozzle</a> for Pricing and Details								
Model Number		Inside Diameter		Width		Watt	Watt Density	
120V	240V	mm	inch	mm	inch		Watt/cm <sup>2</sup>	Watt/in <sup>2</sup>
<b>MBH00030</b>	<b>MBH00034</b>	38.1	1½	25.4	1	150	6.3	40
<b>MBH00003</b>	<b>MBH00012</b>	44.5	1¾	25.4	1	175	6.0	39
<b>MBH00004</b>	<b>MBH00013</b>	50.8	2	25.4	1	200	5.9	38
<b>MBH00005</b>	—	57.2	2¼	25.4	1	175	4.5	29
—	<b>MBH00037</b>	57.2	2¼	38.1	1½	300	5.1	33
<b>MBH00006</b>	<b>MBH00014</b>	63.5	2½	25.4	1	250	5.7	36
<b>MBH00007</b>	<b>MBH00015</b>	76.2	3	25.4	1	200	3.7	24
<b>MBH00009</b>	<b>MBH00016</b>	88.9	3½	25.4	1	300	4.7	30

Ordering Example: MBH00007, 120V, 200 watt, nozzle band heater.

## Nozzle Band Heaters

**Standard Replacement Mica Insulated Band Heaters for Plastic Injection Molding Machines**



**To Order Visit [omega.com/mbh\\_nozzle](http://omega.com/mbh_nozzle) for Pricing and Details**

Model Number	Inside Diameter		Width		Watt	Watt Density		
	240V	mm	inch	mm		inch	Watt/cm <sup>2</sup>	Watt/in <sup>2</sup>
MBH00019		38.1	1½	38.1	1½	275	7.7	49
MBH00020		38.1	1½	44.5	1¾	250	6.0	38
MBH00021		38.1	1½	63.5	2½	400	6.7	43
MBH00022		38.1	1½	76.2	3	450	6.3	40
MBH00023		38.1	1½	114.3	4½	600	5.6	36
MBH00024		44.5	1¾	152.4	6	800	4.6	30
MBH00025		54.0	2⅙	23.8	1⅞	215	6.3	40
MBH00026		58.7	2⅝	23.8	1⅞	260	6.9	44
MBH00027		58.7	2⅝	34.9	1⅞	240	4.3	28
MBH00028		69.9	2¾	38.1	1½	260	3.5	23

All heaters have 609 mm (24") high temperature leads with 559 mm (22") stainless steel overbraid.

Ordering Example: MBH00023, 240V, 600 watt, nozzle band heater.

### Design Features

- All Heaters Have 609 mm (24") High Temperature Leads with 559 mm (22") Stainless Steel Overbraid—Type W3
- Heaters Less Than 38 mm (1½") Wide Have Separate Straps—Type SE
- Designed as One-Piece Expandable Type, Enables You to Open Up the Heater to the Diameter of the Barrel for Easy Installation



**To Order Visit [omega.com/mbh\\_nozzle](http://omega.com/mbh_nozzle) for Pricing and Details**

Model Number			Inside Diameter		Width		Watt	Watt Density		Style
120V	240V	480V	mm	inch	mm	inch		Watt/cm <sup>2</sup>	Watt/in <sup>2</sup>	
MBH00040	—	—	69.9	2¾	88.9	3½	600	3.5	22	NE
MBH00041	MBH00054	—	76.2	3	25.4	1	200	3.7	24	SE
MBH00042	MBH00055	—	76.2	3	25.4	1	250	4.7	30	SE
MBH00043	MBH00056	—	76.2	3	25.4	1	300	5.6	36	SE
MBH00044	MBH00057	—	76.2	3	25.4	1	400	7.4	48	SE
MBH00045	MBH00058	—	76.2	3	38.1	1½	500	6.1	40	NE
—	MBH00059	—	76.2	3	63.5	2½	300	2.2	14	NE
MBH00046	MBH00060	—	88.9	3½	15.9	⅝	200	5.0	32	SE
MBH00047	—	—	88.9	3½	25.4	1	200	3.1	20	SE
—	MBH00061	—	88.9	3½	38.1	1½	500	5.2	33	NE
MBH00048	MBH00062	MBH00066	101.6	4	50.8	2	625	4.2	27	NE
MBH00049	—	—	101.6	4	76.2	3	500	2.2	14	NE
MBH00050	MBH00063	MBH00067	101.6	4	101.6	4	1250	4.2	27	NE
MBH00051	—	—	114.3	4½	25.4	1	300	3.5	23	SE
—	MBH00064	MBH00068	114.3	4½	50.8	2	700	4.1	27	NE
MBH00052	—	—	114.3	4½	101.6	4	700	2.1	13	NE
MBH00053	MBH00065	MBH00069	114.3	4½	101.6	4	1400	4.1	27	NE

Ordering Example: MBH00049, 120V, 500 watt, nozzle band heater.

## Nozzle Band Heaters

### Standard Replacement Mica Insulated Band Heaters for Plastic Injection Molding Machines



#### Design Features

- All Heaters Have 0.61 m (24") High Temperature Leads—Type L2
- Heaters Less Than 38 mm (1½") Wide Have Separate Straps—Type SE
- Designed as One-Piece Expandable Type, Enables You to Open Up the Heater to the Diameter of the Barrel for Easy Installation

<b>To Order Visit <a href="http://omega.com/mbh_nozzle">omega.com/mbh_nozzle</a> for Pricing and Details</b>										
Model Number			Inside Diameter		Width		Watt	Watt Density		Style
120V	240V	480V	mm	inch	mm	inch		Watt/cm <sup>2</sup>	Watt/in <sup>2</sup>	
MBH00070	MBH00078	—	76.2	3	25.4	1	200	3.7	24	SE
MBH00071	MBH00079	—	76.2	3	25.4	1	250	4.6	30	SE
MBH00072	MBH00080	—	76.2	3	25.4	1	300	5.5	36	SE
MBH00073	MBH00081	—	76.2	3	25.4	1	400	7.4	47	SE
MBH00074	MBH00082	—	76.2	3	38.1	1½	400	4.9	32	NE
MBH00075	MBH00083	—	76.2	3	38.1	1½	450	5.5	36	NE
MBH00076	MBH00084	—	76.2	3	38.1	1½	500	6.1	40	NE
MBH00077	MBH00085	—	76.2	3	50.8	2	500	4.6	30	NE
—	MBH00086	—	88.9	3½	25.4	1	400	6.2	40	SE
—	MBH00087	MBH00093	88.9	3½	38.1	1½	250	2.6	17	NE
—	MBH00088	—	88.9	3½	50.8	2	650	5.0	33	NE
—	MBH00089	MBH00094	125.4	4 <sup>15</sup> / <sub>16</sub>	63.5	2½	720	3.1	20	NE
—	MBH00090	MBH00095	139.7	5½	63.5	2½	950	3.6	23	NE
—	MBH00091	MBH00096	149.2	5 <sup>7</sup> / <sub>8</sub>	38.1	1½	675	4.0	26	NE
—	MBH00092	MBH00097	190.5	7½	38.1	1½	1000	4.6	30	NE

Ordering Example: MBH00085, 240V, 500 watt, nozzle band heater.