



# EV2731-QC-00A

## Wide-Input, 4.5A, I<sup>2</sup>C-Controlled SW Charger w/ NVDC Power Path and USB OTG Eval Board

### DESCRIPTION

The EV2731-QC-00A is an evaluation board for designed to demonstrate the capabilities of the MP2731. The MP2731 is a wide-input, 4.5A, highly integrated switch-mode battery charger IC for single-cell Li-ion or Li-polymer batteries. This device supports NVDC architecture with power path management suitable for portable applications including tablets, mobile internet devices, and smartphones.

Its low-impedance power path optimizes efficiency, reduces battery charging time, and extends battery life. The I<sup>2</sup>C serial interface with charging and system settings allows the device to be flexibly controlled.

The EV2731-QC-00A supports up to 16V input sources, including standard USB host ports and high-voltage wall adapters with fast-charge capability. The EV2731-QC-00A supports USB On-the-Go (OTG) operation by supplying 5V with 3.0A.

### ELECTRICAL SPECIFICATIONS

Parameter	Symbol	Value	Units
Input voltage	V <sub>IN</sub>	3.7 to 16	V
Charge full voltage	V <sub>BATT_REG</sub>	4.2, I <sup>2</sup> C-configurable	V
Charge current	I <sub>CC</sub>	1.84, I <sup>2</sup> C-configurable	A
Input voltage regulation	V <sub>IN_MIN</sub>	4.3, I <sup>2</sup> C-configurable	V
Input current limit	I <sub>IN_LIM</sub>	0.5, I <sup>2</sup> C-configurable	A
OTG voltage regulation	V <sub>IN_DSCHG</sub>	5.0, I <sup>2</sup> C-configurable	V
OTG current limit	I <sub>IN_DSCHG</sub>	0.5, I <sup>2</sup> C-configurable	A

### FEATURES

- 3.7V to 16V Operating Input Voltage Range
- Up to 22V Sustainable Voltage
- High Efficiency 1.35MHz 4.5A Buck Charger
  - Programmable D+/D- for Flexible Fast Charge Protocol Support
  - Adjustable Minimum Input Voltage Regulation for MPPT
- USB OTG with 4.8V to 5.5V Adjustable Output, Selectable 1.35MHz Boost Converter, Up to 3.0A Output
- Up to 9A Battery Discharge Current
- Integrated ADC for Monitoring V<sub>IN</sub>, I<sub>IN</sub>, V<sub>BATT</sub>, I<sub>BATT</sub>, V<sub>SYS</sub>, and Battery Temperature
- Narrow Voltage DC (NVDC) Power Path Management
  - Instant-On Works with No Battery or Deeply Discharged Battery
  - Ideal Diode Operation in Battery Supplement Mode
- I<sup>2</sup>C Port for Flexible System Parameter Setting and Status Reporting
- Full DISC Control to Support Shipping Mode and System Restart
- High Accuracy:
  - ±0.5% Charge Voltage Regulation
  - ±5% Charge Current Regulation
  - ±5% Input Current Regulation
  - ±2% Output Regulation in Boost Mode
- Safety Features:
  - Programmable JEITA for Battery Temp Protection
  - Battery Charging Safety Timer
  - Thermal Regulation and Shutdown
  - Input/System Over-Voltage Protection
  - Supports Temp Protection in Battery Side
- Charging Operation Indicator

### APPLICATIONS

- Tablet PCs
- Smartphones
- Mobile Internet Devices

All MPS parts are lead-free, halogen-free, and adhere to the RoHS directive. For MPS green status, please visit the MPS website under Quality Assurance. "MPS", the MPS logo, and "Simple, Easy Solutions" are registered trademarks of Monolithic Power Systems, Inc. or its subsidiaries.

### EV2731-QC-00A EVALUATION BOARD



(LxWxH) 6.3cmx6.3cmx1.3cm

Board Number	MPS IC Number
EV2731-QC-00A	MP2731GQC

#### Efficiency Curve

V<sub>IN</sub> = 5V/9V/12V/16V, V<sub>BATT</sub> = 3.8V, R<sub>L\_DCR</sub> = 21mΩ

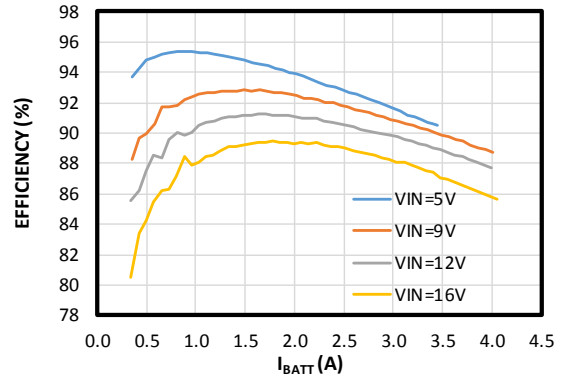

## QUICK START GUIDE

Table 1: Jumper Connections

Jack	Description	Factory Setting
JP3	OTG pin setting: pull high to enable the OTG	Pull low
JP2	CE pin setting: pull low to enable the charge	Pull low
JP1	NTC pin setting: pull low to set the NTC to the fix ratio: 50%	Pull low
P1	I <sup>2</sup> C connector	

The EV2731-QC-00A evaluation board is designed for the MP2731 when used as a standalone switching charger with integrated USB detection and USB On-the-Go function. Its layout accommodates most commonly used capacitors. The default function of this board is preset for charger mode, and the charge-full voltage is preset to 4.2V for a single-cell Li-ion battery.

For a detailed description of the operation of this part, refer to the MP2731 datasheet. Visit the MPS website to access the “MP2731 Evaluation Kit” .exe file.

### Evaluation Platform Preparation

1. Ensure a computer is available with at least one USB port and a USB cable. The MP2731 evaluation software must be properly installed.
2. Prepare the USB-to-I<sup>2</sup>C communication interface (EVKT-USBI2C-02).



Figure 1: USB to I<sup>2</sup>C Communication Interface

3. Software: Double-click on the “MP2731 Evaluation Kit” .exe file to run the MP2731 evaluation software. The software supports the Windows XP, Windows 7, and later operating systems. The MP2731 evaluation kit .exe file can be downloaded from MPS Website by searching for “MP2731”.

4. Configure the test set-up for the MP2731 (see Figure 2).

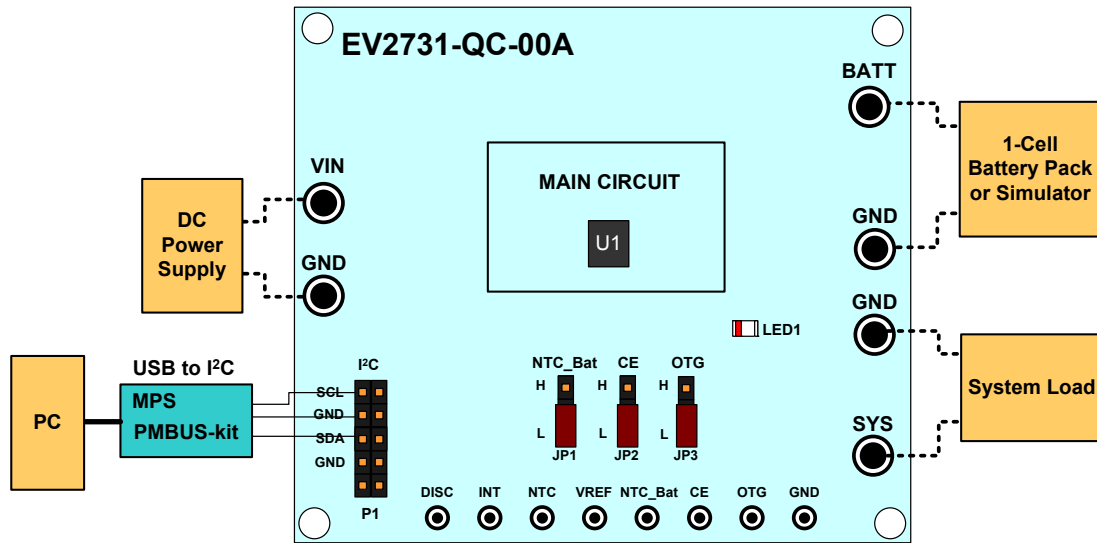

Figure 2: Test Set-Up for the MP2731

5. Turn on the computer, and launch the MP2731 evaluation software. Figure 3 shows the main window of the GUI software.

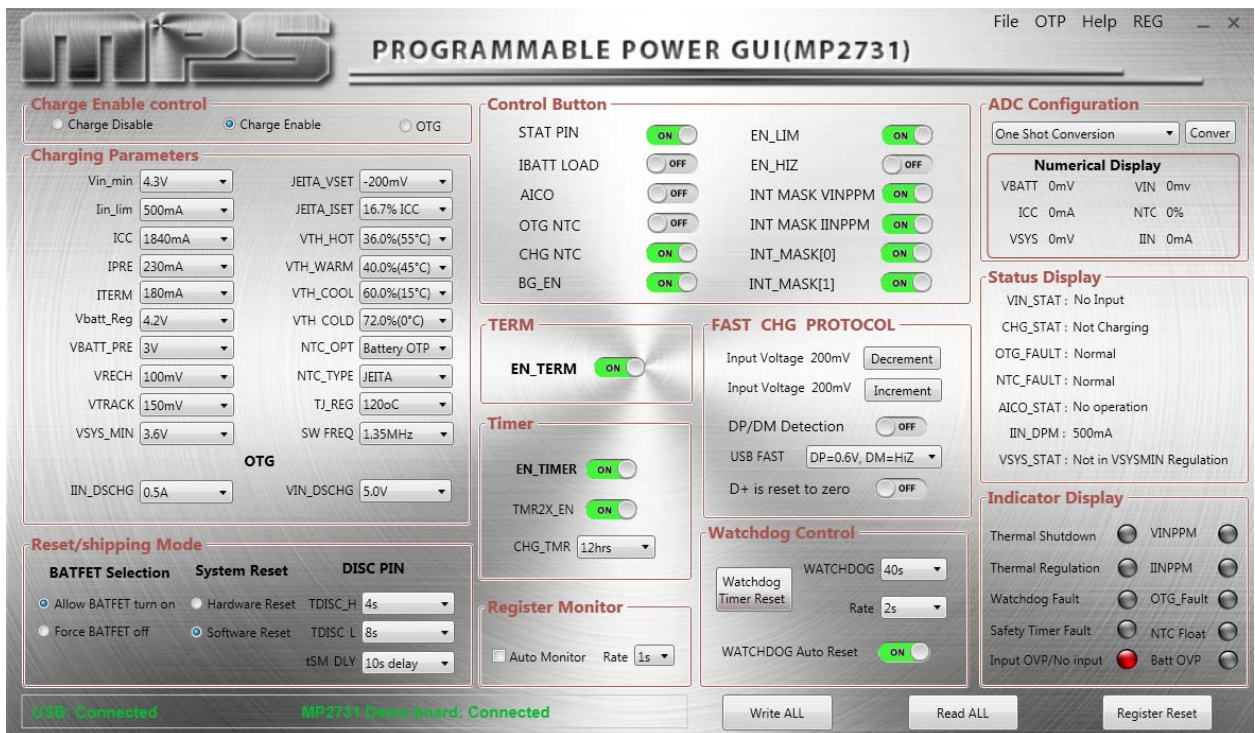
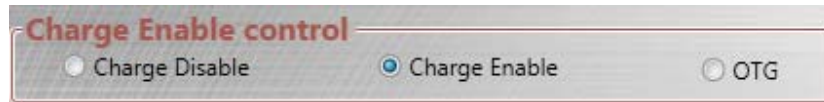

Figure 3: MP2731 Evaluation Software

**Procedure**

1. Ensure that all the connections are normal (the USB is connected and the EV2731-QC-00A is connected). If all these connections are good, this will be indicated in green in the lower-left side of the window (see Figure 3). Now the user can run the program.
2. Select the operation mode for the MP2731 (see Figure 4).

**Figure 4: MP2731 GUI Operation Mode**

3. Set the charging parameters (see Figure 5).

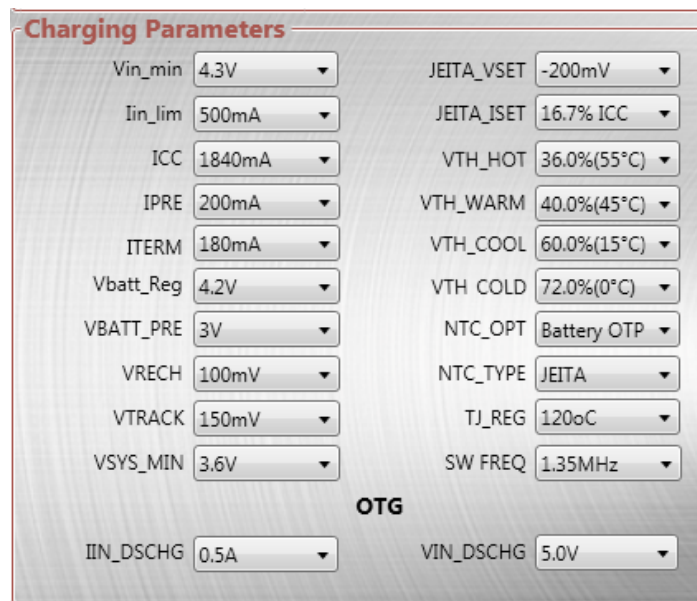
**Figure 5: MP2731 GUI Charging Parameters Display**

4. Set the input voltage regulation threshold (see Figure 6). Its range is 3.7V to 15.2V, and the default value is 4.3V. Set it according to the  $V_{BATT\_REG}$  setting. For example, if  $V_{BATT\_REG}$  is set to 4.35V, this value is recommended to be set to 4.6V or higher.

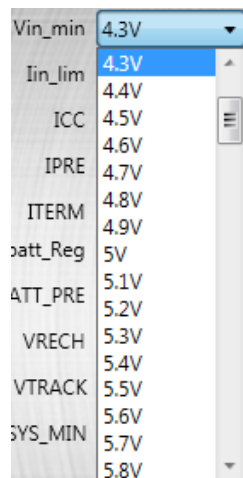
**Figure 6: Input Voltage Regulation Threshold Setting**

- Set the input current limit (see Figure 7). Its range is 100mA to 3250mA, and the default value is 500mA. Set it to the value that meets the input source capacity.

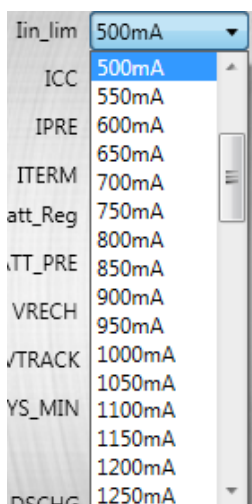

**Figure 7: Input Current Limit Setting**

The input current limit can be set lower than the maximum current rating of the input source. When the input current reaches its set limit, the charge current is decreased to keep the input current constant at this limit in order to safely power the system.

- Set the constant charge current (see Figure 8). Its range is 320mA to 4520mA, and the default charge current is set at 1840mA. The real charge current is limited as the input current limit setting.

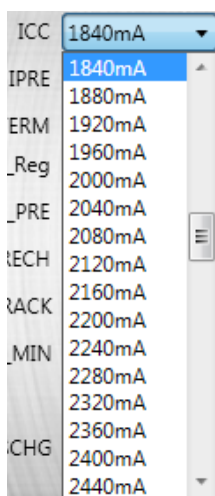

**Figure 8: Constant Charge Current Setting**

- Set the pre-charge current (see Figure 9). Its range is 150mA to 750mA, and the default value is 230mA.

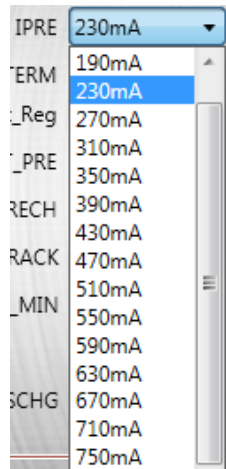

**Figure 9: Pre-Charge Current Setting**

- Set the terminal charge current (see Figure 10). Its range is 100mA to 700mA, and the default value is 180mA.

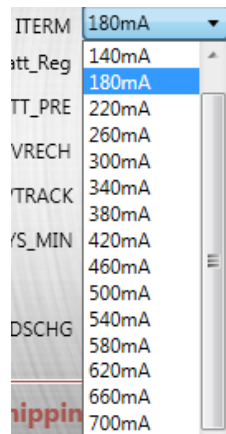

**Figure 10: Terminal Charge Current Setting**

- Set the charge-full voltage (see Figure 11). Its range is 3.4V to 4.67V, and the default value is 4.2V.

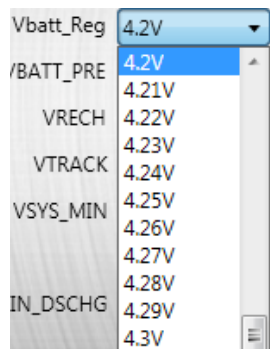

**Figure 11: Charge-Full Voltage Setting**

10. Set pre-charge to constant current charge threshold voltage (see Figure 12). Its options are 2.8V or 3.0V, and the default value is 3.0V.

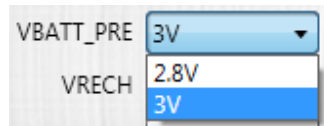

**Figure 12: V<sub>BATT\_PRE</sub> Setting**

11. Set the battery auto-recharge voltage to V<sub>BATT\_REG</sub> minus the setting value (see Figure 13). Its options are 100mV or 200mV, and the default value is 100mV.

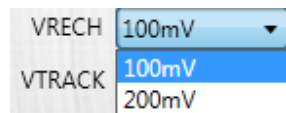

**Figure 13: V<sub>RECH</sub> Setting**

12. Set the voltage variation between SYS regulation voltage and V<sub>SYS\_MIN</sub> (see Figure 14). Its options are 100mV or 150mV, and the default value is 150mV.

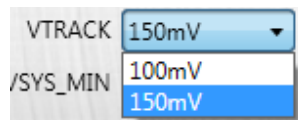

**Figure 14: V<sub>TRACK</sub> Setting**

13. Set the V<sub>SYS\_MIN</sub> voltage threshold (see Figure 15). Its range is 3V to 3.75V, and the default value is 3.6V.

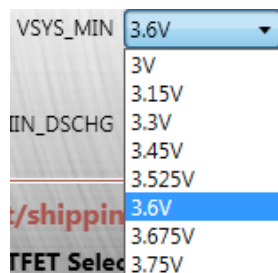

**Figure 15: V<sub>SYS\_MIN</sub> Setting**

14. Set the switching frequency (see Figure 16). Its range is 1.35MHz or 1MHz, and the default value is 1.35MHz.

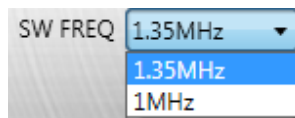

**Figure 16: Switching Frequency Setting**



15. Set the NTC functions according to the selected NTC thermistor and requirements (see Figure 17). If this function is not included during the evaluation, leave the default settings.

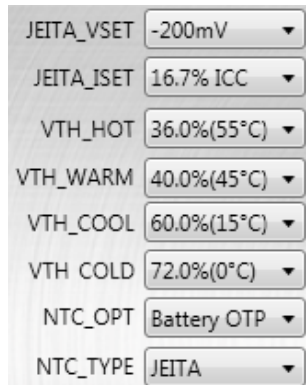

**Figure 17: NTC Functions Settings**

16. Set the thermal regulation threshold (see Figure 18) Its range is 60°C to 120°C, and the default value is 120°C.

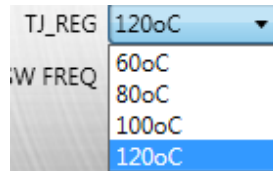

**Figure 18: Thermal Regulation Threshold Setting**

17. Select the termination setting (see Figure 19).



**Figure 19: Termination Setting**

18. Set charge timer (see Figure 20). Its range is 5hrs to 20hrs, and the default value is 12hrs.

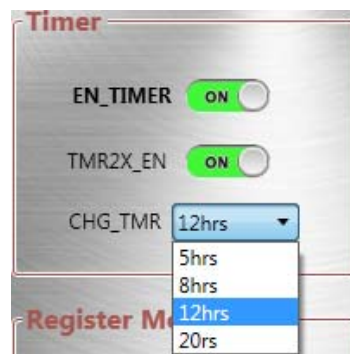

**Figure 20: Charge Timer Setting**

The integrated charge timer provides backup protection to prevent a damaged battery from being charged after a certain time. The MP2731 can disable the timer function by switching off the EN\_TIMER button (see Figure 20).

### Boost Function

When the MP2731 is programmed to On-the-Go (OTG) mode, the output voltage and current limit can be controlled via the I<sup>2</sup>C.

1. Turn off and disconnect the power from VIN to PGND.
2. If the constant voltage load connected from BATT+ to GND is not a four-quadrant supply (source current), remove the load and use the power source disconnected in step 1. Then set a 4.0V voltage limit and 3.5A current limit with a connection between BATT+ and PGND.
3. Apply a resistor (5W or greater, R = 3Ω to 10Ω) across VIN(+) to PGND(-).
4. Pull JP3 to high, and select OTG from the Charge Enable Control menu (see Figure 21).

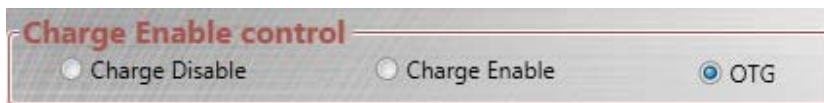

**Figure 21: Charge Enable Control Menu**

5. Set the OTG output voltage regulation (see Figure 22). Its range is 4.8V to 5.5V, and the default value is 5.0V.

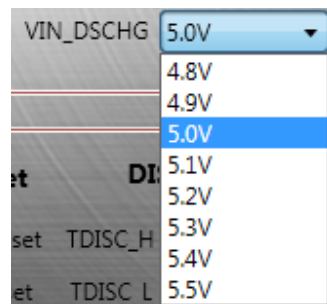

**Figure 22: OTG Output Voltage Regulation Setting**

6. Set the OTG current limit (see Figure 23). Its range is 0.5A to 3.0A, and the default value is 0.5A.

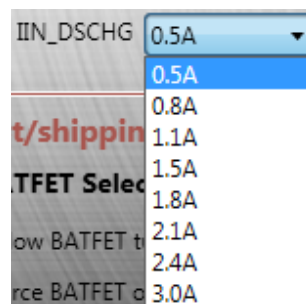
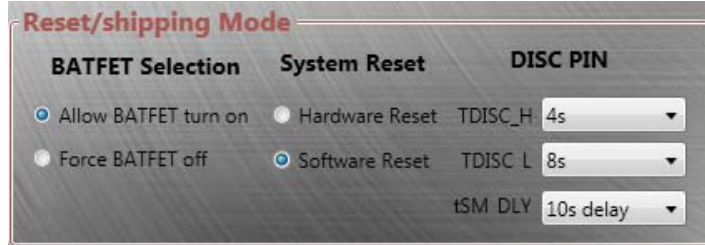

**Figure 23: OTG Current Limit Setting**

**Other Controls**

The MP2731 evaluation software offers other controls as well. Other controls include:

- Shipping mode control (see Figure 24)



**Figure 24: Shipping Mode Control**

- Watchdog control (see Figure 25)



**Figure 25: Watchdog Control**

- A register auto-monitor function (see Figure 26)



**Figure 26: Register Auto-Monitor**

- ADC configuration (see Figure 27)

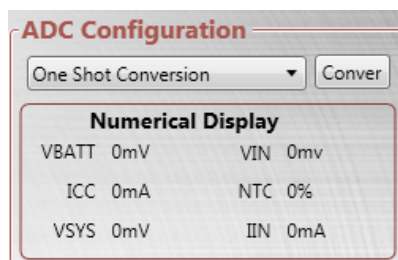

**Figure 27: ADC Configuration**

- Fast charge protocol control (see Figure 28)

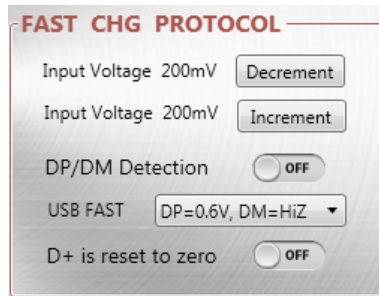

Figure 28: Fast Charge Protocol Setting

- MP2731 operation status monitoring (see Figure 29)

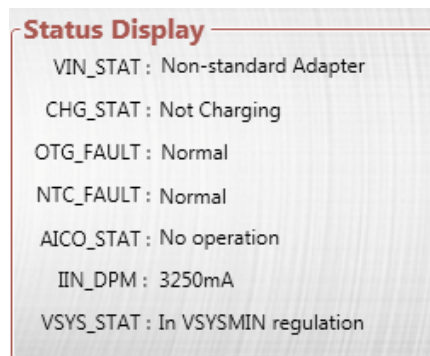

Figure 29: Operation Status Display

- MP2731 fault monitoring (see Figure 30)

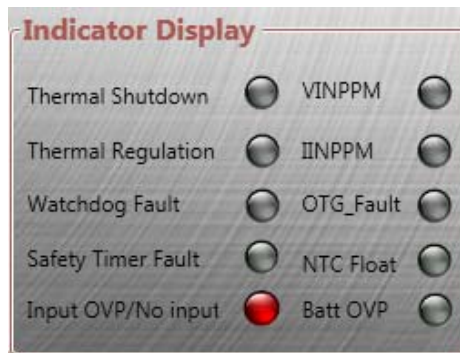

Figure 30: Fault Monitoring Indicator Display

- And others (see Figure 31)

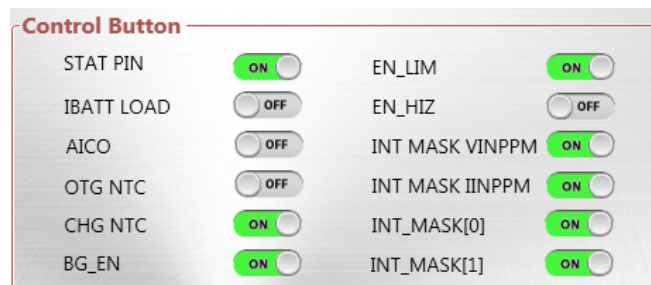
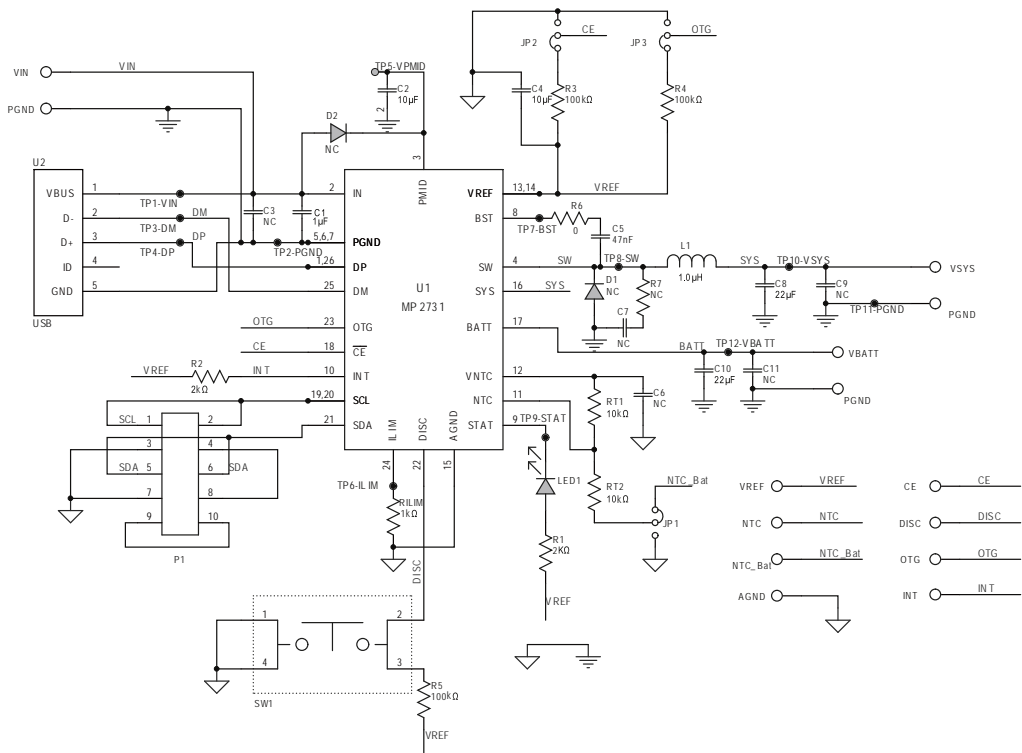

Figure 31: Other Controls

**EVALUATION BOARD SCHEMATIC (1)**



**Note:**

- 1) For SYS capacitor C8, a 22µF X5R/X7R capacitor with 1206 package is recommended for better performance.

**EV2731-QC-00A BILL OF MATERIALS**

Qty	Ref	Value	Description	Package	Manufacturer	Manufacturer PN
1	C1	1μF	Ceramic capacitor, 25V, X7R, 0603	0603	muRata	GRM188R71E105KA12D
1	C2	10μF	Ceramic capacitor, 50V, X5R, 1206	1206	muRata	GRM31CR61H106KA12L
1	C3	NC	Ceramic capacitor, 50V, X5R, 1206	1206	muRata	
1	C4	10μF	Ceramic capacitor, 16V, X5R, 0603	0603	muRata	GRM188R61C106KAALD
1	C5	47nF	Ceramic capacitor, 50V, X7R, 0603	0603	muRata	GRM188R71H473KA61D
2	C6, C7	NC	Ceramic capacitor, 16V, X5R, 0603	0603	muRata	
2	C8, C10	22μF	Ceramic capacitor, 16V, X5R, 1206	1206	muRata	GRM31CR61C226KE15L
2	C9, C11	NC	Ceramic capacitor, 16V, X5R, 0805	0805	muRata	
2	D1, D2	NC	Diode, 50V, 3A	SMA	HQ	
1	L1	1.0μH	Inductor, 1.0μH	SMD	Cyntec	HTEP32251B-1R0MIR-89
1	LED1	Red	BL-HUF35A-TRB	0805	Bright LED	BL-HUF35A-TRB
2	R1, R2	2kΩ	Film Resistor, 1%	0603	Yageo	RC0603FR-072KL
3	R3, R4, R5	100kΩ	Film Resistor, 5%	0603	Yageo	RC0603JR-07100KL
1	R6	0Ω	Film Resistor, 1%	0603	Yageo	RC0603FR-070RL
1	R7	NC	Film Resistor, 1%	0603	Yageo	
1	RILIM	1kΩ	Film Resistor, 1%	0603	Yageo	RC0603FR-071KL
2	RT1, RT2	10kΩ	Film Resistor, 1%	0603	Yageo	RC0603FR-0710KL
1	SW1		Button, SM 4mmx10mm, 1.5mm height			
3	JP1, JP2, JP3		2.54mm connector			
3	JP1, JP2, JP3		2.54mm connector, shorter			
1	P1		Header, 5-pin, dual row			

**EV2731-QC-00A BILL OF MATERIALS (continued)**

Qty	Ref	Value	Description	Package	Manufacturer	Manufacture PN
8	DISC, VREF, AGND, OTG, CE, INT, NTC, NTC_BATT		2.54mm connector			
12	DM, DP, VBATT, GND, VSYS, BST, STAT, SW VPMID, GND, VIN, ILIM		Test point (yellow)			
6	VIN, PGND, VBATT, PGND, PGND, VSYS		2mm			
1	U1	MP2731	IC	QFN-26 (3.5mmx3.5mm)	MPS	MP2731GQC-0000
1	U2	Micro- USB	Micro-USB	DIP	Wurth	629105150521

## EVB TEST RESULTS

$V_{IN} = 5.0V$ ,  $V_{BATT} = \text{full range}$ , I<sup>2</sup>C-controlled,  $I_{CC} = 0A \text{ to } 3A$ ,  $I_{IN\_LIM} = 3250mA$ ,  $V_{IN\_MIN} = 4.3V$ ,  $T_A = 25^\circ C$ ,  $L1 = 1.0\mu H$ ,  $C_{BATT} = 22\mu F$ ,  $C_{SYS} = 22\mu F$ ,  $C_{IN} = 1\mu F$ ,  $C_{PMID} = 10\mu F$ , unless otherwise noted.

### Battery Charge Curve

$V_{IN} = 5V$ ,  $V_{BATT\_REG} = 4.2V$ ,  $I_{SYS} = 0A$

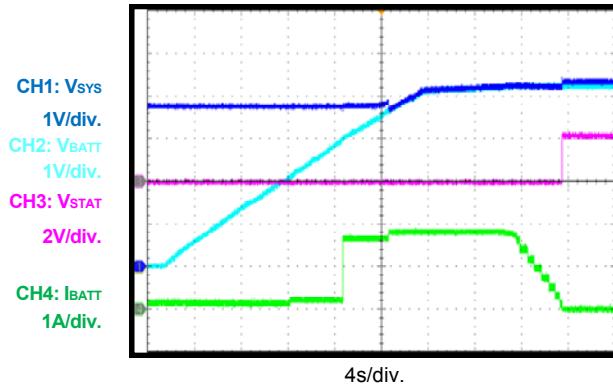

### Auto-Recharge

$V_{IN} = 5V$ ,  $V_{BATT\_REG} = 4.2V$ ,  $I_{SYS} = 0A$

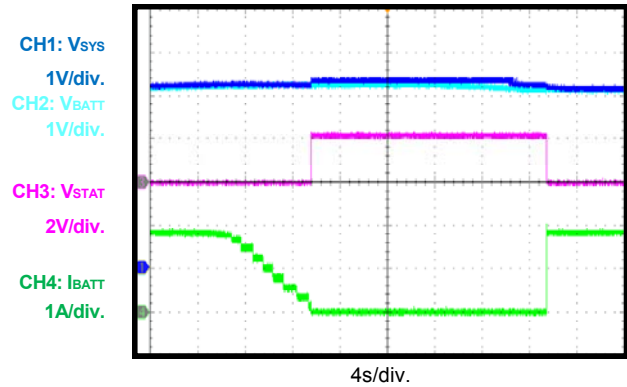

### Trickle Charge

$V_{IN} = 5V$ ,  $V_{BATT} = 1.0V$ ,  $I_{SYS} = 500mA$

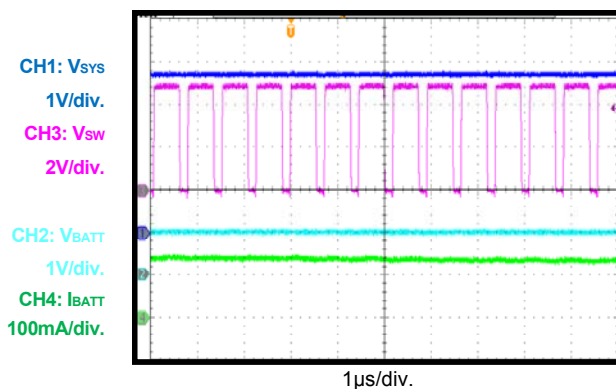

### Pre-Charge

$V_{IN} = 5V$ ,  $V_{BATT} = 2.5V$ ,  $I_{PRE} = 680mA$

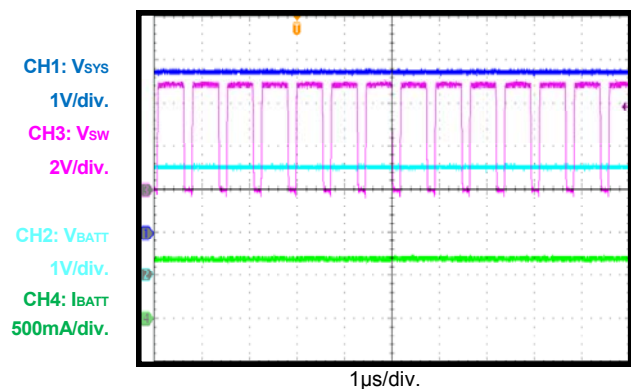

### Constant Current Charge

$V_{IN} = 5V$ ,  $V_{BATT} = 3.3V$ ,  $I_{CC} = 1840mA$

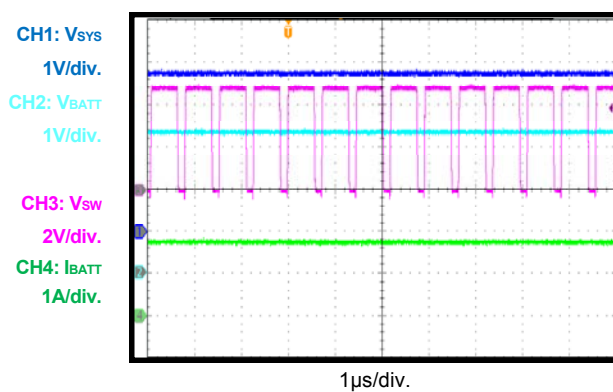

### Constant Current Charge

$V_{IN} = 5V$ ,  $V_{BATT} = 3.8V$ ,  $I_{CC} = 1840mA$

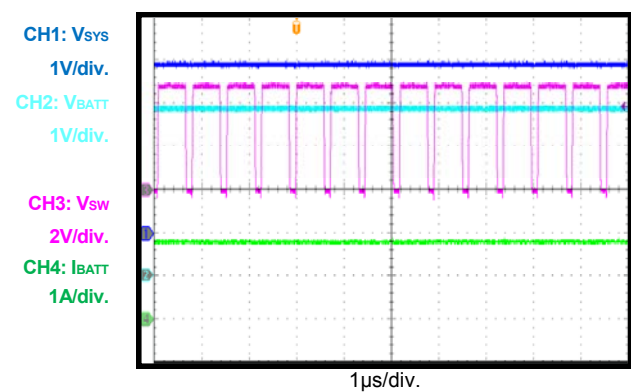



### EVB TEST RESULTS (continued)

$V_{IN} = 5.0V$ ,  $V_{BATT} = \text{full range}$ , I<sup>2</sup>C-controlled,  $I_{CC} = 0A \text{ to } 3A$ ,  $I_{IN\_LIM} = 3250mA$ ,  $V_{IN\_MIN} = 4.3V$ ,  $T_A = 25^\circ C$ ,  $L1 = 1.0\mu H$ ,  $C_{BATT} = 22\mu F$ ,  $C_{SYS} = 22\mu F$ ,  $C_{IN} = 1\mu F$ ,  $C_{PMID} = 10\mu F$ , unless otherwise noted.

#### Constant Current Charge

$V_{IN} = 9V$ ,  $V_{BATT} = 3.3V$ ,  $I_{CC} = 1840mA$

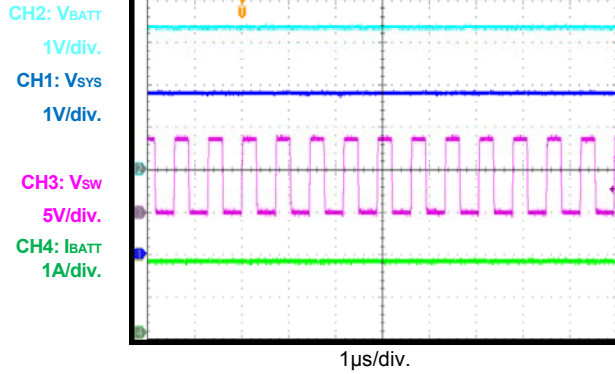

#### Constant Current Charge

$V_{IN} = 9V$ ,  $V_{BATT} = 3.8V$ ,  $I_{CC} = 1840mA$

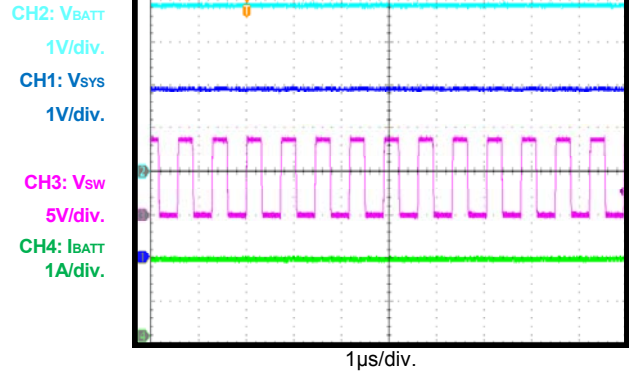

#### Constant Current Charge

$V_{IN} = 12V$ ,  $V_{BATT} = 3.3V$ ,  $I_{CC} = 1840mA$

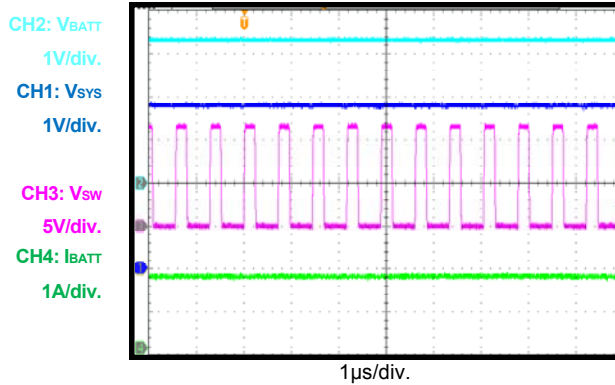

#### Constant Current Charge

$V_{IN} = 12V$ ,  $V_{BATT} = 3.8V$ ,  $I_{CC} = 1840mA$

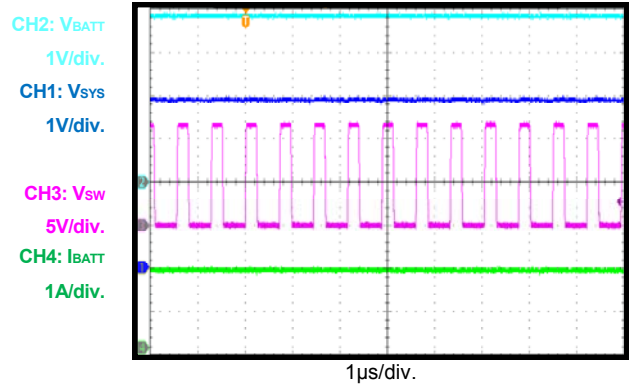

#### Constant Current Charge

$V_{IN} = 16V$ ,  $V_{BATT} = 3.3V$ ,  $I_{CC} = 1840mA$

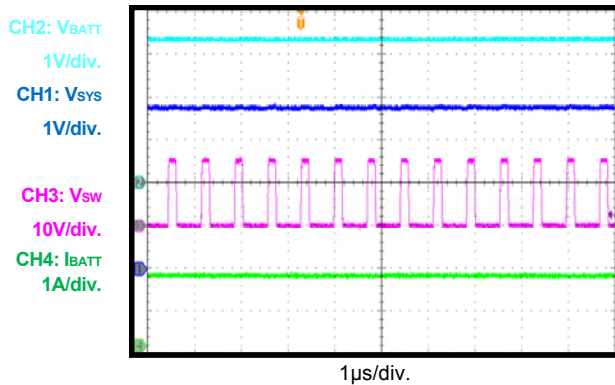

#### Constant Current Charge

$V_{IN} = 16V$ ,  $V_{BATT} = 3.8V$ ,  $I_{CC} = 1840mA$

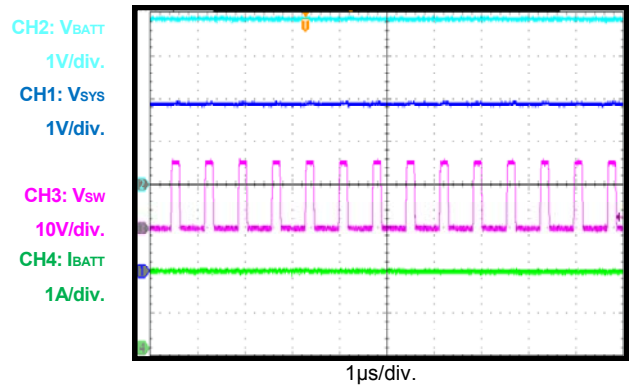

**EVB TEST RESULTS (continued)**

$V_{IN} = 5.0V$ ,  $V_{BATT} = \text{full range}$ , I<sup>2</sup>C-controlled,  $I_{CC} = 0A$  to  $3A$ ,  $I_{IN\_LIM} = 3250mA$ ,  $V_{IN\_MIN} = 4.3V$ ,  $T_A = 25^\circ C$ ,  $L_1 = 1.0\mu H$ ,  $C_{BATT} = 22\mu F$ ,  $C_{SYS} = 22\mu F$ ,  $C_{IN} = 1\mu F$ ,  $C_{PMID} = 10\mu F$ , unless otherwise noted.

**Battery Supplement Mode**

$V_{IN} = 5V$ ,  $V_{BATT} = 3.8V$ ,  $I_{SYS} = 4.5A$

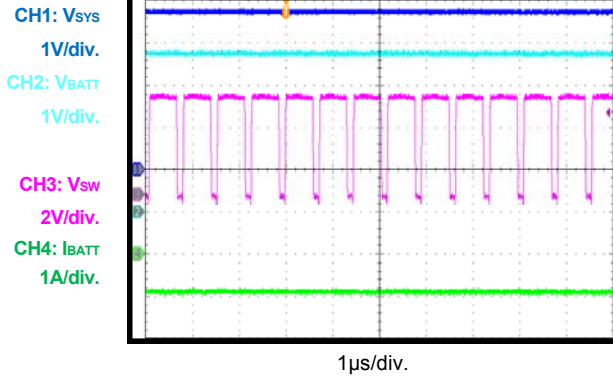
**Constant Voltage Charge**

$V_{IN} = 5V$ ,  $V_{BATT} = 4.19V$ ,  $I_{SYS} = 0A$

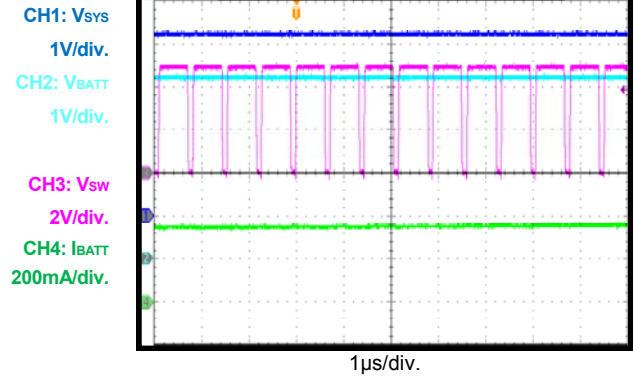
**Input Current Limit**

$V_{IN} = 5V$ ,  $V_{BATT} = 3.8V$ ,  $I_{IN\_LIM} = 1800mA$

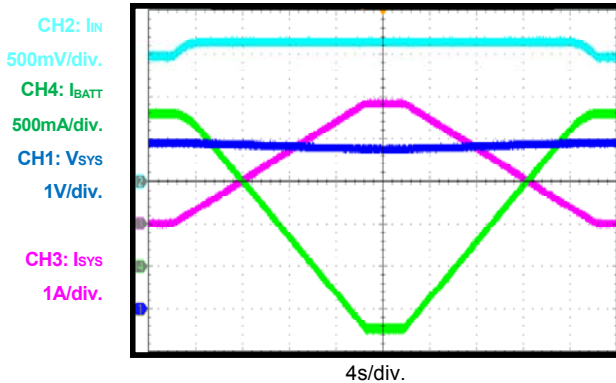
**Input Voltage Limit**

$V_{IN} = 5V$  (2A),  $V_{BATT} = 3.3V$ ,  $V_{IN\_MIN} = 4.6V$

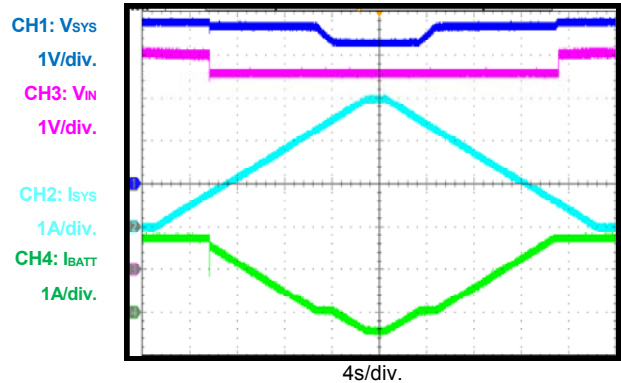
**Power-On/Off Waveform**

$V_{IN} = 5V$ ,  $I_{IN\_LIM} = 500mA$ ,  $V_{BATT} = 3.8V$ ,  $I_{SYS} = 2.5A$

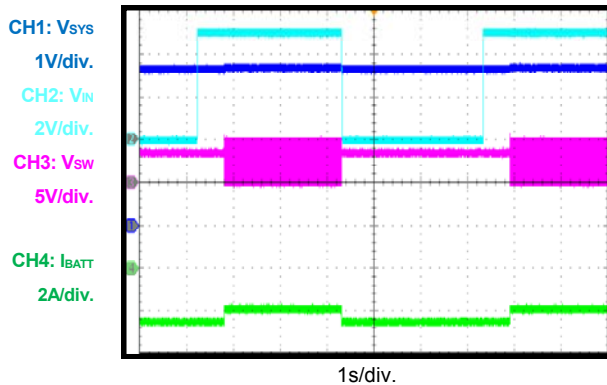
**Power-On/Off Waveform**

$V_{IN} = 5V$ ,  $I_{IN\_LIM} = 500mA$ ,  $V_{BATT} = 3.3V$ ,  $I_{SYS} = 0.5A$

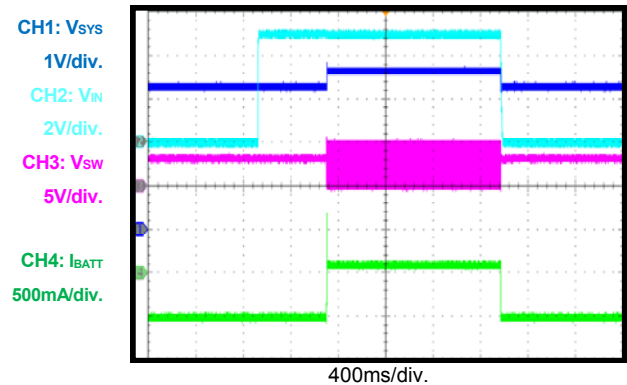

**EVB TEST RESULTS (continued)**

V<sub>IN</sub> = 5.0V, V<sub>BATT</sub> = full range, I<sup>2</sup>C-controlled, I<sub>CC</sub> = 0A to 3A, I<sub>IN\_LIM</sub> = 3250mA, V<sub>IN\_MIN</sub> = 4.3V, T<sub>A</sub> = 25°C, L<sub>1</sub> = 1.0μH, C<sub>BATT</sub> = 22μF, C<sub>SYS</sub> = 22μF, C<sub>IN</sub> = 1μF, C<sub>PMID</sub> = 10μF, unless otherwise noted.

**Suspend Mode On/Off**

V<sub>IN</sub> = 5V, I<sub>IN\_LIM</sub> = 500mA, V<sub>BATT</sub> = 4.0V, I<sub>SYS</sub> = 0.5A

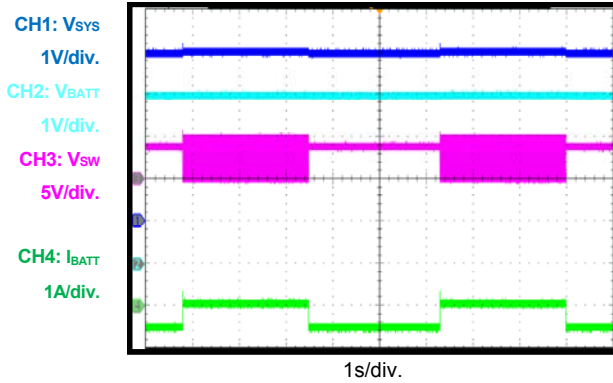

**Charge On/Off**

V<sub>IN</sub> = 5V, V<sub>BATT</sub> = 4.0V, I<sub>SYS</sub> = 0A

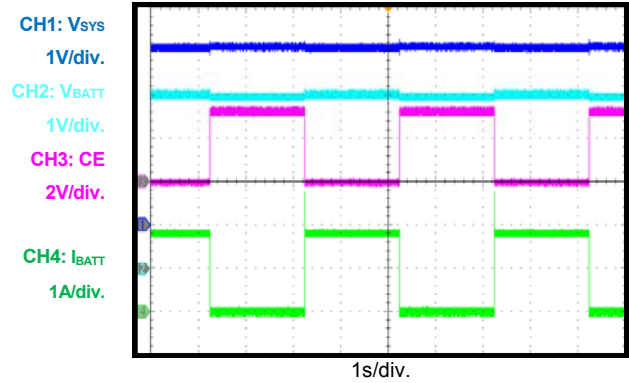

**BATFET On/Off**

V<sub>IN</sub> = 5V, V<sub>BATT</sub> = 4.0V, I<sub>SYS</sub> = 4A

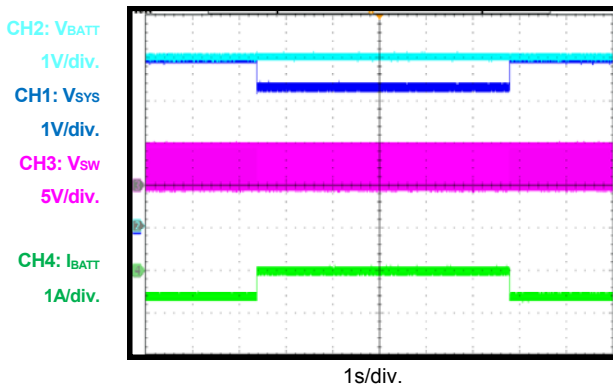

**VIN Hot Insertion/Removal**

V<sub>IN</sub> = 5V, I<sub>IN\_LIM</sub> = 500mA, V<sub>BATT</sub> = 3.8V

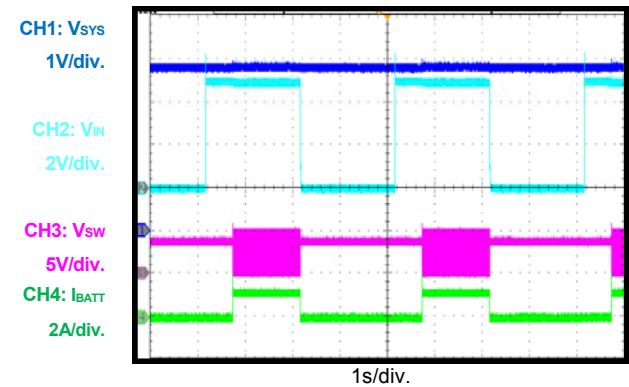

**SYS Load Transient**

V<sub>IN</sub> = 5V, V<sub>BATT</sub> = 3.3V, charge disable, I<sub>SYS</sub> = 1A to 3A

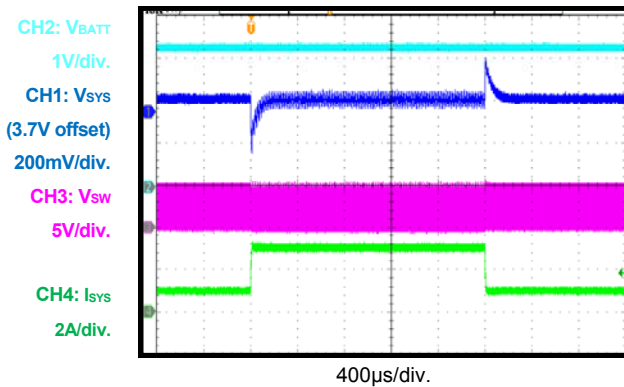

**VIN OVP Test**

V<sub>IN</sub> = 5V to 17V, V<sub>BATT</sub> = 3.8V, I<sub>SYS</sub> = 1A

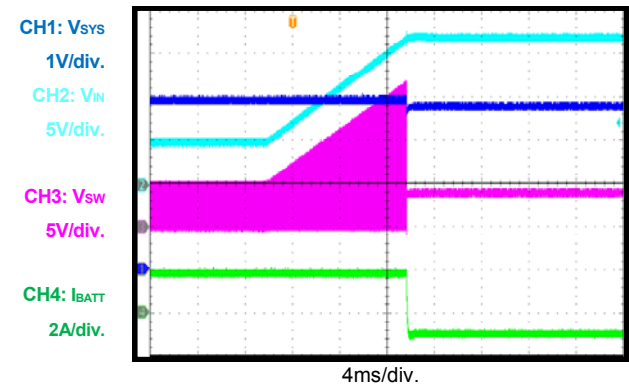

**EVB TEST RESULTS (continued)**

$V_{IN} = 5.0V$ ,  $V_{BATT} = \text{full range}$ , I<sup>2</sup>C-controlled,  $I_{CC} = 0A$  to  $3A$ ,  $I_{IN\_LIM} = 3250mA$ ,  $V_{IN\_MIN} = 4.3V$ ,  $T_A = 25^\circ C$ ,  $L1 = 1.0\mu H$ ,  $C_{BATT} = 22\mu F$ ,  $C_{SYS} = 22\mu F$ ,  $C_{IN} = 1\mu F$ ,  $C_{PMID} = 10\mu F$ , unless otherwise noted.

**System Reset Mode**

$V_{IN} = \text{float}$ ,  $V_{BATT} = 3.8V$ ,  $I_{SYS} = 2A$

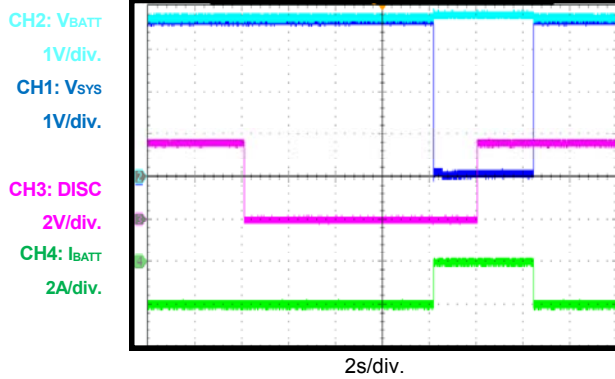
**Battery Discharge Current**

$V_{IN} = \text{float}$ ,  $V_{BATT} = 4.0V$ ,  $I_{SYS} = \text{up to } 10A$

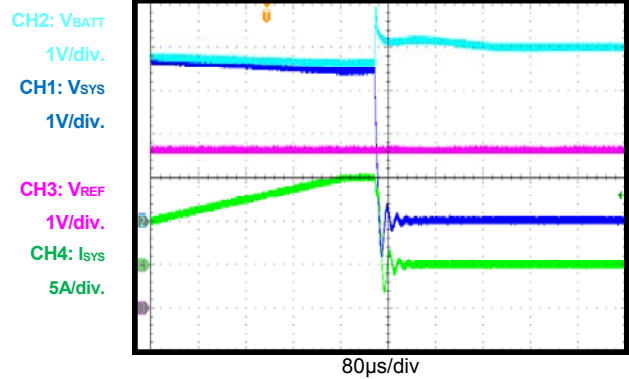
**OTG Mode On**

$V_{IN} = \text{float}$ , OTG mode,  $V_{BATT} = 3.3V$ ,  $I_{IN\_DSCHG} = 0.5A$ ,  $I_{OTG} = 0.5A$

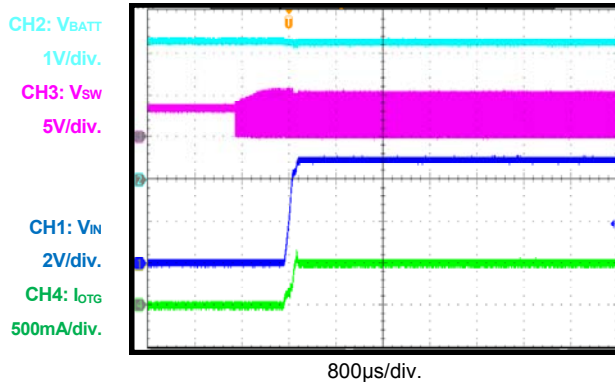
**OTG Steady State Operation**

$V_{IN} = \text{float}$ , OTG mode,  $V_{BATT} = 4.0V$ ,  $I_{IN\_DSCHG} = 3.0A$ ,  $I_{OTG} = 1.5A$

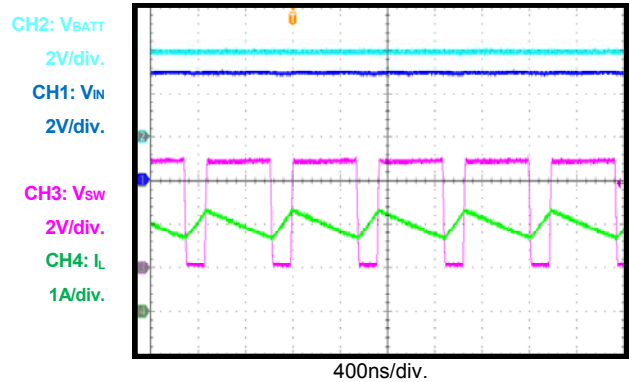
**OTG Voltage Regulation**

$V_{IN} = \text{float}$ , OTG mode,  $V_{BATT} = 4.0V$ ,  $I_{IN\_DSCHG} = 1.5A$ ,  $I_{OTG} = 0A$  to  $1.5A$

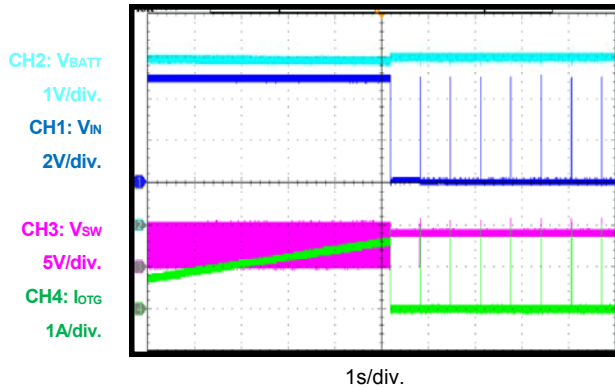
**NTC JEITA Operation**

$V_{IN} = 5V$ ,  $V_{BATT} = 4.07V$ ,  $I_{SYS} = 0A$ , JEITA\_ISET = 50%, JEITA\_VSET = -100mV

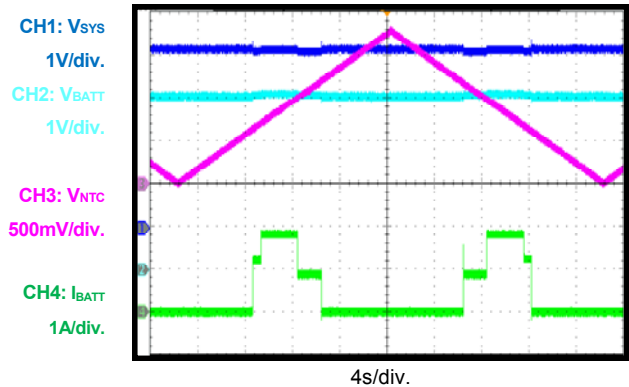

## PCB LAYOUT

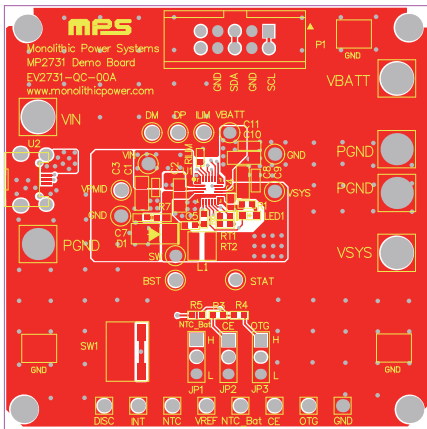

Figure 32: Top Layer

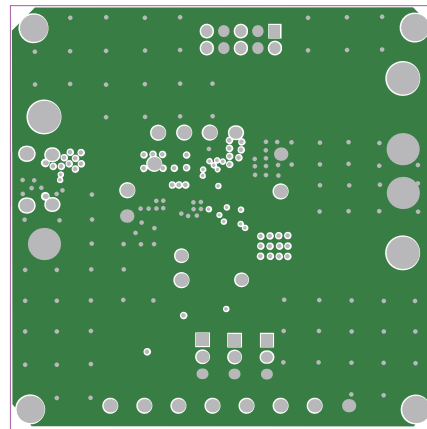

Figure 33: Mid-Layer 1

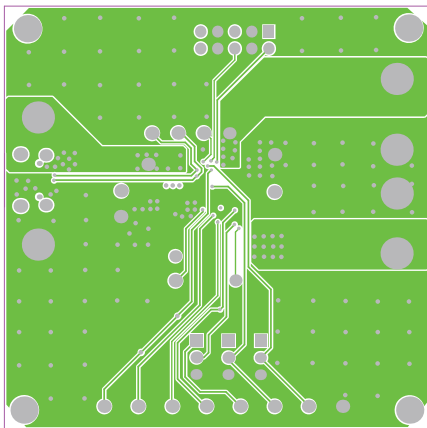

Figure 34: Mid-Layer 2

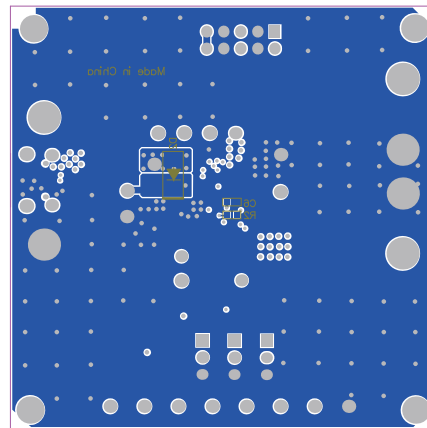

Figure 35: Bottom Layer

**NOTICE:** The information in this document is subject to change without notice. Please contact MPS for current specifications. Users should warrant and guarantee that third-party Intellectual Property rights are not infringed upon when integrating MPS products into any application. MPS will not assume any legal responsibility for any said applications.