

**Data sheet | Item number: 2250-1204**

2-conductor miniature through terminal block; with push-button; 1 mm<sup>2</sup>; with test port; side and center marking; for DIN-15 rail; Push-in CAGE CLAMP®; 1,00 mm<sup>2</sup>; blue

[www.wago.com/2250-1204](http://www.wago.com/2250-1204)

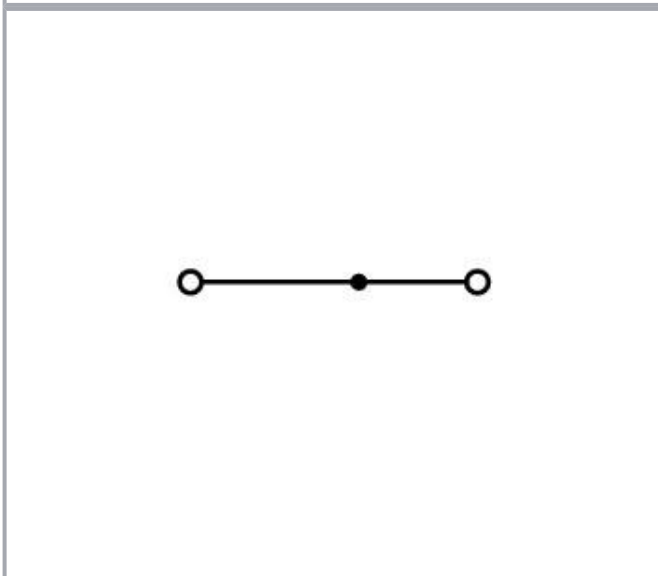
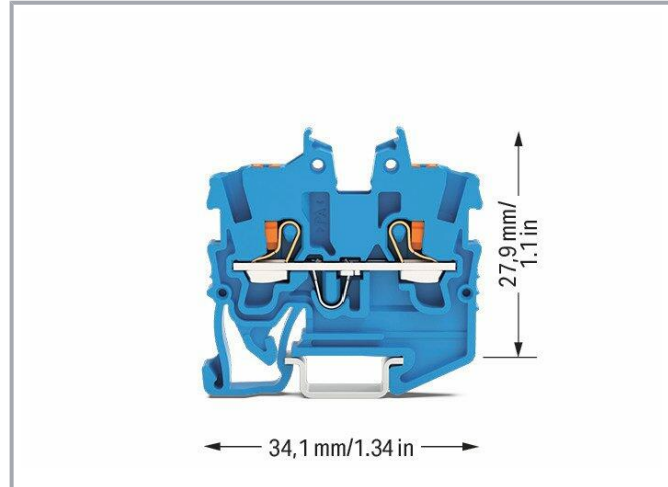
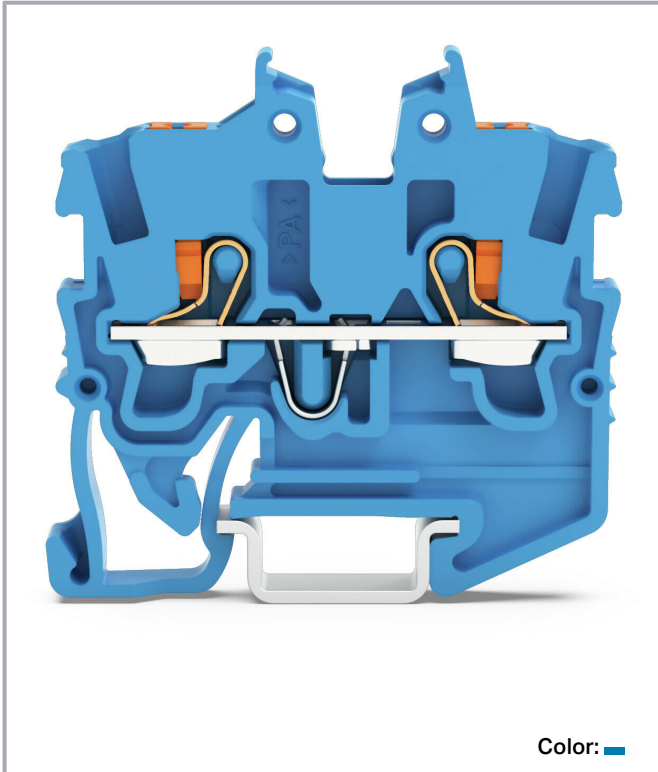

Subject to changes. Please also observe the further product documentation!

WAGO Private Limited  
NH No. 8, Block No. 94 Vadsala,  
Block No. 1187 Varnama, Village Varnama / Vadsala  
Ta. & Distt. Vadodara, Vadodara, Gujarat-391243  
Phone: +91-265-6812100 | Email: [info.india@wago.com](mailto:info.india@wago.com)

Do you have any questions about our products?  
We are always happy to take your call at +49 (571) 887-44222.



## Data

### Electrical data

#### Ratings per IEC/EN

Ratings per	IEC/EN 60947-7-1
Nominal voltage (III/3)	500 V
Rated surge voltage (III/3)	6 kV
Rated current	13.5 A
Rated current 2	17.5 A
Legend (ratings)	(III / 3) $\hat{=}$ Overvoltage category III / Pollution degree 3

#### Ratings per UL

Approvals per	UL 1059
Rated voltage UL (Use Group B)	300 V
Rated current UL (Use Group B)	10 A
Rated voltage UL (Use Group C)	300 V
Rated current UL (Use Group C)	10 A

#### Ratings per CSA

Approvals per	C22.2 No 158
Rated voltage CSA (Use Group B)	300 V
Rated current CSA (Use Group B)	10 A
Rated voltage CSA (Use Group C)	300 V
Rated current CSA (Use Group C)	10 A

#### Ex information

Rated voltage EN (Ex e II)	352 V
Rated current (Ex e II)	13.5 A
Rated current (Ex e II) with jumper	12 A
Ratings (note)	See Downloads – Documentation – Additional Information: Technical explanations

#### Connection data

Total number of connection points	2
Total number of potentials	1
Number of levels	1

Subject to changes. Please also observe the further product documentation!



Number of jumper slots	1
------------------------	---

## Connection 1

Connection technology	Push-in CAGE CLAMP®
Actuation type	Push-in Push-button Operating tool
Connectable conductor materials	Copper
Nominal cross-section	1 mm <sup>2</sup>
Solid conductor	0.14 ... 1.5 mm <sup>2</sup> / 24 ... 16 AWG
Solid conductor; push-in termination	0.5 ... 1.5 mm <sup>2</sup> / 20 ... 16 AWG
Fine-stranded conductor	0.14 ... 1.5 mm <sup>2</sup> / 24 ... 16 AWG
Fine-stranded conductor; with insulated ferrule	0.14 ... 0.75 mm <sup>2</sup> / 24 ... 18 AWG
Fine-stranded conductor; with ferrule; push-in termination	0.5 ... 0.75 mm <sup>2</sup> / 20 ... 18 AWG
Note (conductor cross-section)	Depending on the conductor characteristic, a conductor with a smaller cross-section can also be inserted via push-in termination.
Strip length	9 ... 11 mm / 0.35 ... 0.43 inch
Wiring direction	Front-entry wiring

## Physical data

Width	3.5 mm / 0.138 inch
Height	34.1 mm / 1.343 inch
Depth from upper edge of DIN-rail	27.9 mm / 1.098 inch

## Mechanical data

Design	horizontal type
Mounting type	DIN-15 rail
Marking level	Center/side marking

## Material data

Note on material data	Information on material data can be found here
Color	blue
Insulation material	Polyamide (PA66)
Flammability class per UL94	V0
Fire load	0.048 MJ
Weight	2.4 g





Subject to changes. Please also observe the further product documentation!

## Commercial data

PU (SPU)	100 Stück
Packaging type	box
Country of origin	DE
GTIN	4055143965736
Customs tariff number	85369010000

## Approvals / Certificates

### Ex-Approvals

Logo	Approval	Additional Approval Text	Certificate name
	<b>AEx</b> Underwriters Laboratories Inc.	UL 60079	E185892 (AEx eb IIC resp. Ex eb IIC)
	<b>ATEX</b> Physikalisch Technische Bundesanstalt	EN IEC 60079-0	PTB 19 ATEX 1019 U (II 2G Ex eb IIC Gb or I M 2 Ex eb I Mb)
	<b>CCCEX</b> CQST/CNEx	CNCA-C23-01	2020312313000289
	<b>IECEX</b> Physikalisch Technische Bundesanstalt	IEC 60079	IECEX PTB 19.0050 U (Ex eb IIC Gb or EX eb I Mb)

### Country specific Approvals

Logo	Approval	Additional Approval Text	Certificate name
	<b>CCA</b> DEKRA Certification B.V.	EN 60947	NTR NL 7839
	<b>CCA</b> DEKRA Certification B.V.	EN 60998	NTR NL 7840
	<b>CSA</b> CSA	C22.2 No. 158	80034182

Subject to changes. Please also observe the further product documentation!



KEMA/KEUR  
DEKRA Certification B.V.

EN 60947

71-  
113930



KEMA/KEUR  
DEKRA Certification B.V.

EN 60998

71-  
113957

#### UL-Approvals

Logo	Approval	Additional Approval Text	Certificate name
	cURus Underwriters Laboratories Inc.	UL 1059	E45172

#### Required accessories

##### End plate

End plate



Item no.: 2050-1291  
End and intermediate plate; 1.1 mm thick; gray

[www.wago.com/2050-1291](http://www.wago.com/2050-1291)

#### Optional accessories

##### Carrier rail

Mounting accessories



Item no.: 210-295  
Steel carrier rail; 15 x 5.5 mm; 1 mm thick; 2 m long; unslotted; according to EN 60715; silver-colored

[www.wago.com/210-295](http://www.wago.com/210-295)

Item no.: 210-296  
Aluminum carrier rail; 15 x 5.5 mm; 1 mm thick; 2 m long; unslotted; similar to EN 60715; silver-colored

[www.wago.com/210-296](http://www.wago.com/210-296)

Item no.: 210-111  
Steel carrier rail; 15 x 5.5 mm; 1 mm thick; 2 m long; slotted; according to EN 60715; silver-colored

[www.wago.com/210-111](http://www.wago.com/210-111)

#### Testing and measuring

Testing accessories



Item no.: 2009-174  
Test plug adapter; for 4 mm Ø test plugs; for testing TOPJOB®S rail-mounted terminal blocks; gray

[www.wago.com/2009-174](http://www.wago.com/2009-174)

Subject to changes. Please also observe the further product documentation!



**Item no.: 2009-182**

Testing tap; for max. 2.5 mm<sup>2</sup>; tool-free connection for individual test wires 0.08 - 2.5 mm; gray

[www.wago.com/2009-182](http://www.wago.com/2009-182)



**Item no.: 210-136**

Test plug; 2 mm Ø; with 500 mm cable; red

[www.wago.com/210-136](http://www.wago.com/210-136)

## Tool

### Operating tool

**Item no.: 210-648**

Operating tool; Blade: 2.5 x 0.4 mm; with a partially insulated shaft; angled; short

[www.wago.com/210-648](http://www.wago.com/210-648)

**Item no.: 210-647**

Operating tool; Blade: 2.5 x 0.4 mm; with a partially insulated shaft; multicoloured

[www.wago.com/210-647](http://www.wago.com/210-647)



**Item no.: 210-719**

Operating tool; Blade: 2.5 x 0.4 mm; with a partially insulated shaft

[www.wago.com/210-719](http://www.wago.com/210-719)

## Mounting

### Mounting accessories



**Item no.: 249-101**

Screwless end stop; 6 mm wide; for WMB markers; gray

[www.wago.com/249-101](http://www.wago.com/249-101)



**Item no.: 709-156**

Cover; Type 3; suitable for cover carrier, type 3; 1 m long; transparent

[www.wago.com/709-156](http://www.wago.com/709-156)



**Item no.: 709-169**

Cover carrier; Type 3; gray

[www.wago.com/709-169](http://www.wago.com/709-169)

## Jumpers

### Jumper

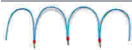

**Item no.: 210-123**

Wire commoning chain; insulated; blue

[www.wago.com/210-123](http://www.wago.com/210-123)



**Item no.: 2000-408**

Jumper; 8-way; insulated; light gray

[www.wago.com/2000-408](http://www.wago.com/2000-408)



**Item no.: 2000-407**

Jumper; 7-way; insulated; light gray

[www.wago.com/2000-407](http://www.wago.com/2000-407)



**Item no.: 2000-409**

Jumper; 9-way; insulated; light gray

[www.wago.com/2000-409](http://www.wago.com/2000-409)















**Item no.: 2000-408/000-006**







Jumper; 8-way; insulated; blue

[www.wago.com/2000-408/000-006](http://www.wago.com/2000-408/000-006)

Subject to changes. Please also observe the further product documentation!













	<b>Item no.:</b> 2000-408/000-005 Jumper; 8-way; insulated; red	<a href="http://www.wago.com/2000-408/000-005">www.wago.com/2000-408/000-005</a>
	<b>Item no.:</b> 2000-409/000-005 Jumper; 9-way; insulated; red	<a href="http://www.wago.com/2000-409/000-005">www.wago.com/2000-409/000-005</a>
	<b>Item no.:</b> 2000-407/000-006 Jumper; 7-way; insulated; blue	<a href="http://www.wago.com/2000-407/000-006">www.wago.com/2000-407/000-006</a>
	<b>Item no.:</b> 2000-410 Jumper; 10-way; insulated; light gray	<a href="http://www.wago.com/2000-410">www.wago.com/2000-410</a>
	<b>Item no.:</b> 2000-410/000-006 Jumper; 10-way; insulated; blue	<a href="http://www.wago.com/2000-410/000-006">www.wago.com/2000-410/000-006</a>
	<b>Item no.:</b> 2000-433/000-005 Jumper; from 1 to 3; insulated; red	<a href="http://www.wago.com/2000-433/000-005">www.wago.com/2000-433/000-005</a>
	<b>Item no.:</b> 2000-407/000-005 Jumper; 7-way; insulated; red	<a href="http://www.wago.com/2000-407/000-005">www.wago.com/2000-407/000-005</a>
	<b>Item no.:</b> 2000-433/000-006 Jumper; from 1 to 3; insulated; blue	<a href="http://www.wago.com/2000-433/000-006">www.wago.com/2000-433/000-006</a>
	<b>Item no.:</b> 2000-410/000-005 Jumper; 10-way; insulated; red	<a href="http://www.wago.com/2000-410/000-005">www.wago.com/2000-410/000-005</a>
	<b>Item no.:</b> 2000-435 Jumper; from 1 to 5; insulated; light gray	<a href="http://www.wago.com/2000-435">www.wago.com/2000-435</a>
	<b>Item no.:</b> 2000-409/000-006 Jumper; 9-way; insulated; blue	<a href="http://www.wago.com/2000-409/000-006">www.wago.com/2000-409/000-006</a>
	<b>Item no.:</b> 2000-436 Jumper; from 1 to 6; insulated; light gray	<a href="http://www.wago.com/2000-436">www.wago.com/2000-436</a>
	<b>Item no.:</b> 2000-433 Jumper; from 1 to 3; insulated; light gray	<a href="http://www.wago.com/2000-433">www.wago.com/2000-433</a>
	<b>Item no.:</b> 2000-434 Jumper; from 1 to 4; insulated; light gray	<a href="http://www.wago.com/2000-434">www.wago.com/2000-434</a>

Subject to changes. Please also observe the further product documentation!













	<b>Item no.: 2000-402</b> Jumper; 2-way; insulated; light gray	<a href="http://www.wago.com/2000-402">www.wago.com/2000-402</a>
	<b>Item no.: 2000-402/000-006</b> Jumper; 2-way; insulated; blue	<a href="http://www.wago.com/2000-402/000-006">www.wago.com/2000-402/000-006</a>
	<b>Item no.: 2000-403</b> Jumper; 3-way; insulated; light gray	<a href="http://www.wago.com/2000-403">www.wago.com/2000-403</a>
	<b>Item no.: 2000-402/000-005</b> Jumper; 2-way; insulated; red	<a href="http://www.wago.com/2000-402/000-005">www.wago.com/2000-402/000-005</a>
	<b>Item no.: 2000-402/000-018</b> Jumper; 2-way; insulated; yellow-green	<a href="http://www.wago.com/2000-402/000-018">www.wago.com/2000-402/000-018</a>
	<b>Item no.: 2000-404</b> Jumper; 4-way; insulated; light gray	<a href="http://www.wago.com/2000-404">www.wago.com/2000-404</a>
	<b>Item no.: 2000-403/000-005</b> Jumper; 3-way; insulated; red	<a href="http://www.wago.com/2000-403/000-005">www.wago.com/2000-403/000-005</a>
	<b>Item no.: 2000-404/000-006</b> Jumper; 4-way; insulated; blue	<a href="http://www.wago.com/2000-404/000-006">www.wago.com/2000-404/000-006</a>
	<b>Item no.: 2000-403/000-006</b> Jumper; 3-way; insulated; blue	<a href="http://www.wago.com/2000-403/000-006">www.wago.com/2000-403/000-006</a>
	<b>Item no.: 2000-404/000-005</b> Jumper; 4-way; insulated; red	<a href="http://www.wago.com/2000-404/000-005">www.wago.com/2000-404/000-005</a>
	<b>Item no.: 2000-405</b> Jumper; 5-way; insulated; light gray	<a href="http://www.wago.com/2000-405">www.wago.com/2000-405</a>
	<b>Item no.: 2000-405/011-000</b> Star point jumper; 3-way; insulated; light gray	<a href="http://www.wago.com/2000-405/011-000">www.wago.com/2000-405/011-000</a>
	<b>Item no.: 2000-405/000-006</b> Jumper; 5-way; insulated; blue	<a href="http://www.wago.com/2000-405/000-006">www.wago.com/2000-405/000-006</a>
	<b>Item no.: 2000-406/000-006</b> Jumper; 6-way; insulated; blue	<a href="http://www.wago.com/2000-406/000-006">www.wago.com/2000-406/000-006</a>

Subject to changes. Please also observe the further product documentation!



	<b>Item no.: 2000-405/000-005</b> Jumper; 5-way; insulated; red	<a href="http://www.wago.com/2000-405/000-005">www.wago.com/2000-405/000-005</a>
	<b>Item no.: 2000-406</b> Jumper; 6-way; insulated; light gray	<a href="http://www.wago.com/2000-406">www.wago.com/2000-406</a>
	<b>Item no.: 2000-406/000-005</b> Jumper; 6-way; insulated; red	<a href="http://www.wago.com/2000-406/000-005">www.wago.com/2000-406/000-005</a>
	<b>Item no.: 2000-406/020-000</b> Delta jumper; insulated; light gray	<a href="http://www.wago.com/2000-406/020-000">www.wago.com/2000-406/020-000</a>
	<b>Item no.: 2000-437</b> Jumper; from 1 to 7; insulated; light gray	<a href="http://www.wago.com/2000-437">www.wago.com/2000-437</a>
	<b>Item no.: 2000-438</b> Jumper; from 1 to 8; insulated; light gray	<a href="http://www.wago.com/2000-438">www.wago.com/2000-438</a>
	<b>Item no.: 2000-439</b> Jumper; from 1 to 9; insulated; light gray	<a href="http://www.wago.com/2000-439">www.wago.com/2000-439</a>
	<b>Item no.: 2000-440</b> Jumper; from 1 to 10; insulated; light gray	<a href="http://www.wago.com/2000-440">www.wago.com/2000-440</a>
	<b>Item no.: 210-103</b> Wire commoning chain; insulated; black	<a href="http://www.wago.com/210-103">www.wago.com/210-103</a>
<b>Marking accessories</b>		
Marking strip		
	<b>Item no.: 2009-110</b> Marking strips; for Smart Printer; on reel; not stretchable; plain; snap-on type; white	<a href="http://www.wago.com/2009-110">www.wago.com/2009-110</a>
Marker		
	<b>Item no.: 2009-113</b> WMB-Inline; for Smart Printer; 2300 pieces on roll; plain; snap-on type; white	<a href="http://www.wago.com/2009-113">www.wago.com/2009-113</a>
	<b>Item no.: 2009-113/000-002</b> WMB-Inline; for Smart Printer; 2300 pieces on roll; plain; snap-on type; yellow	<a href="http://www.wago.com/2009-113/000-002">www.wago.com/2009-113/000-002</a>
	<b>Item no.: 2009-113/000-012</b> WMB-Inline; for Smart Printer; 2300 pieces on roll; plain; snap-on type; orange	<a href="http://www.wago.com/2009-113/000-012">www.wago.com/2009-113/000-012</a>

Subject to changes. Please also observe the further product documentation!

	<b>Item no.: 2009-113/000-007</b> WMB-Inline; for Smart Printer; 2300 pieces on roll; plain; snap-on type; gray	<a href="http://www.wago.com/2009-113/000-007">www.wago.com/2009-113/000-007</a>
	<b>Item no.: 2009-113/000-005</b> WMB-Inline; for Smart Printer; 2300 pieces on roll; plain; snap-on type; red	<a href="http://www.wago.com/2009-113/000-005">www.wago.com/2009-113/000-005</a>
	<b>Item no.: 2009-113/000-017</b> WMB-Inline; for Smart Printer; 2300 pieces on roll; plain; snap-on type; light green	<a href="http://www.wago.com/2009-113/000-017">www.wago.com/2009-113/000-017</a>
	<b>Item no.: 2009-113/000-006</b> WMB-Inline; for Smart Printer; 2300 pieces on roll; plain; snap-on type; blue	<a href="http://www.wago.com/2009-113/000-006">www.wago.com/2009-113/000-006</a>
	<b>Item no.: 2009-113/000-024</b> WMB-Inline; for Smart Printer; 2300 pieces on roll; plain; snap-on type; violet	<a href="http://www.wago.com/2009-113/000-024">www.wago.com/2009-113/000-024</a>
	<b>Item no.: 2009-113/000-023</b> WMB-Inline; for Smart Printer; 2300 pieces on roll; plain; snap-on type; green	<a href="http://www.wago.com/2009-113/000-023">www.wago.com/2009-113/000-023</a>
	<b>Item no.: 793-3501</b> WMB marking card; as card; plain; snap-on type; white	<a href="http://www.wago.com/793-3501">www.wago.com/793-3501</a>
Group marker carrier		
	<b>Item no.: 2009-191</b> Group marker carrier; gray	<a href="http://www.wago.com/2009-191">www.wago.com/2009-191</a>
<b>Ferrule</b>		
Ferrule		
	<b>Item no.: 216-241</b> Ferrule; Sleeve for 0.5 mm <sup>2</sup> / 20 AWG; insulated; electro-tin plated; electrolytic copper; gastight crimped; acc. to DIN 46228, Part 4/09.90; white	<a href="http://www.wago.com/216-241">www.wago.com/216-241</a>
	<b>Item no.: 216-242</b> Ferrule; Sleeve for 0.75 mm <sup>2</sup> / 18 AWG; insulated; electro-tin plated; electrolytic copper; gastight crimped; acc. to DIN 46228, Part 4/09.90; gray	<a href="http://www.wago.com/216-242">www.wago.com/216-242</a>
	<b>Item no.: 216-243</b> Ferrule; Sleeve for 1 mm <sup>2</sup> / AWG 18; insulated; electro-tin plated; electrolytic copper; gastight crimped; acc. to DIN 46228, Part 4/09.90; red	<a href="http://www.wago.com/216-243">www.wago.com/216-243</a>
<b>Push-in type wire jumper</b>		
Jumper		
	<b>Item no.: 2009-404</b> Push-in type wire jumper; 0.75 mm <sup>2</sup> ; insulated; 110 mm long; gray	<a href="http://www.wago.com/2009-404">www.wago.com/2009-404</a>
	<b>Item no.: 2009-402</b> Push-in type wire jumper; 0.75 mm <sup>2</sup> ; insulated; 60 mm long; gray	<a href="http://www.wago.com/2009-402">www.wago.com/2009-402</a>

Subject to changes. Please also observe the further product documentation!



Item no.: 2009-406

Push-in type wire jumper; 0.75 mm<sup>2</sup>; insulated; 250 mm long; gray

[www.wago.com/2009-406](http://www.wago.com/2009-406)

## Downloads

### Documentation

#### Additional Information

Technical Section	pdf	Download
Technical explanations	2.2 MB	

## CAD/CAE-Data

### CAD data

2D/3D Models 2250-1204	URL	Download
------------------------	-----	----------

### CAE data

ZUKEN Portal 2250-1204	URL	Download
------------------------	-----	----------

EPLAN Data Portal 2250-1204	URL	Download
-----------------------------	-----	----------

	URL	Download
--	-----	----------

## Environmental Product Compliance

### Compliance Search

Environmental Product Compliance 2250-1204	URL	Download
--	-----	----------

2-conductor miniature through terminal block; with push-button; 1 mm<sup>2</sup>; with test port; side and center marking; for DIN-15 rail; Push-in CAGE CLAMP®; 1,00 mm<sup>2</sup>; blue

## Installation Notes

### Installation

Subject to changes. Please also observe the further product documentation!

WAGO Private Limited  
NH No. 8, Block No. 94 Vadsala,  
Block No. 1187 Varnama, Village Varnama / Vadsala  
Ta. & Distt. Vadodara, Vadodara, Gujarat-391243  
Phone: +91-265-6812100 | Email: [info.india@wago.com](mailto:info.india@wago.com)

Do you have any questions about our products?  
We are always happy to take your call at +49 (571) 887-44222.



### Conductor termination



Insert solid conductors via push-in termination.



Insert ferruled conductors via push-in termination.



Insert fine-stranded conductors via operating tool.

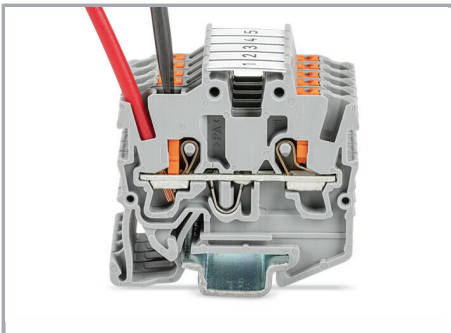

Remove all conductors via operating tool.

### Commoning

Subject to changes. Please also observe the further product documentation!



Insert a jumper (delta jumper) and push down until it hits the backstop (picture shows terminal blocks with push-buttons).

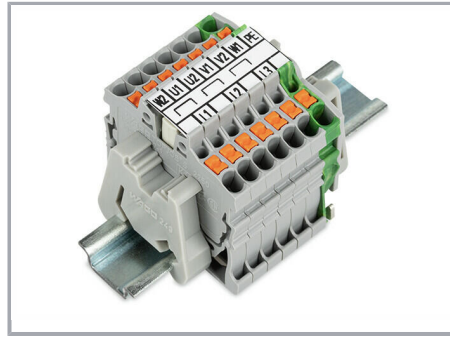

Marking strip (2009-110) inserted in the marking slot with jumper symbols of the inserted jumper (picture shows terminal blocks with push-buttons)

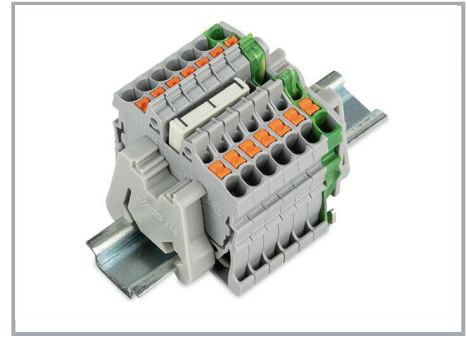

Insert a jumper (star point jumper) and push down until it hits the backstop (picture shows terminal blocks with push-buttons).

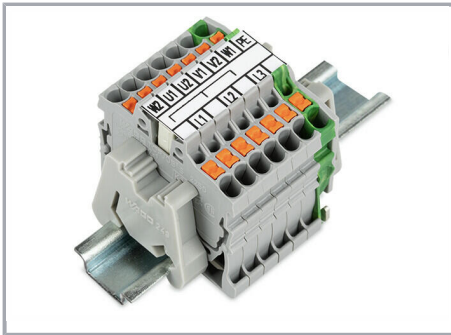

Marking strip (2009-110) inserted in the marking slot with jumper symbols of the inserted jumper (2000-405/011-000 Delta Jumper) (picture shows terminal blocks with push-buttons)

### Testing



Testing with a 2 mm Ø 210-136 Test Plug (max. 42 V).

### Marking

Subject to changes. Please also observe the further product documentation!

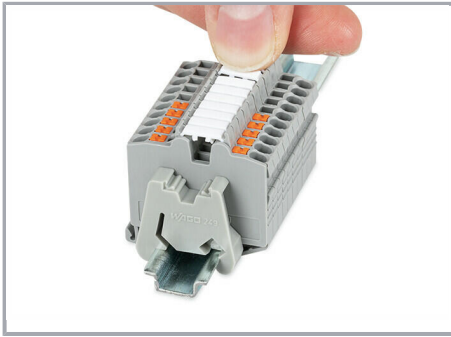

Snapping a WMB marking strip into a marker slot.



Snapping a marking strip (2009-110) into a marker slot.

## Product family

### TOPJOB® S

TOPJOB® S: In various industrial applications and modern building installations, WAGO's wide and versatile range of rail-mount terminal blocks provides more than just reliable electrical connections.

[Show all products from the family](#)

Subject to changes. Please also observe the further product documentation!