



MP5496

2.8V to 5.5V, Power Management IC with Four 4.5A/2.5A/4A/2A Buck Converters, 5 LDOs, and Flexible System Settings via I²C and OTP

DESCRIPTION

The MP5496 is a complete power management solution that integrates four high-efficiency, step-down DC/DC converters, five low-dropout (LDO) regulators, and a flexible logic interface.

A DC/DC converter with constant-on-time (COT) control provides fast transient response. The default 1.5MHz fixed switching frequency during continuous conduction mode (CCM) greatly reduces the external inductor and capacitor values. Full protection features include under-voltage lockout (UVLO), over-current protection (OCP), and thermal shutdown.

The output voltage is adjustable through the I²C interface, or can be preset by the one-time programmable (OTP) function. The start-up and shutdown sequences can be configured via the OTP.

By using the I²C or OTP, the MP5496 can be utilized to configure the buck and LDO output voltages, mode, buck 1 and buck 3 current limits, and the enable function of all the buck converters and LDOs (ENBUCK/LDO).

When using only the I²C interface, the MP5496 allows users to configure the buck 2 and buck 4 current limits, slew rate (DVS slew rate), discharge (DISCHG), system enable (SYSEN), and software reset (SFRST). Status and ID2 registers can also be read via the I²C.

Additional features, such as AUTOON, frequency, power-on delay, RST delay, push-button time, LDORTC output voltage, OTP version, and the I²C slave address can only be configured via the OTP.

The MP5496 requires a minimal number of external components, and is available in a space-saving QFN-28 (4mmx4mm) package.

FEATURES

Four High-Efficiency Step-Down Converters

- Buck 1: 4.5A DC/DC Converter
- Buck 2: 2.5A DC/DC Converter
- Buck 3: 4A DC/DC Converter
- Buck 4: 2A DC/DC Converter
- 0.6V to 2.1875V/12.5mV Step V_{OUT} Range
- 2.8V to 5.5V Operating Input Range
- Adjustable Switching Frequency
- Configurable Forced PWM, Auto-PFM/PWM Mode
- Hiccup Over-Current Protection (OCP)

Five Low-Dropout Regulators

- One RTC-Dedicated LDO
- Four Low-Noise LDOs
- Two Separate Input Power Supplies
- 100mV Dropout at 300mA Load

System

- I²C Bus and OTP
- Power-On/Off Button
- Power-On Reset Output
- Flexible Power-On/Off Sequencing via OTP
- Flexible DC/DC, LDO On/Off via OTP

APPLICATIONS

- Cable Modems, Set-Top Boxes
- Televisions
- Wi-Fi Routers/Access Points
- PoS Machines
- SSDs
- IP Cameras

All MPS parts are lead-free, halogen-free, and adhere to the RoHS directive. For MPS green status, please visit the MPS website under Quality Assurance. "MPS", the MPS logo, and "Simple, Easy Solutions" are trademarks of Monolithic Power Systems, Inc. or its subsidiaries.

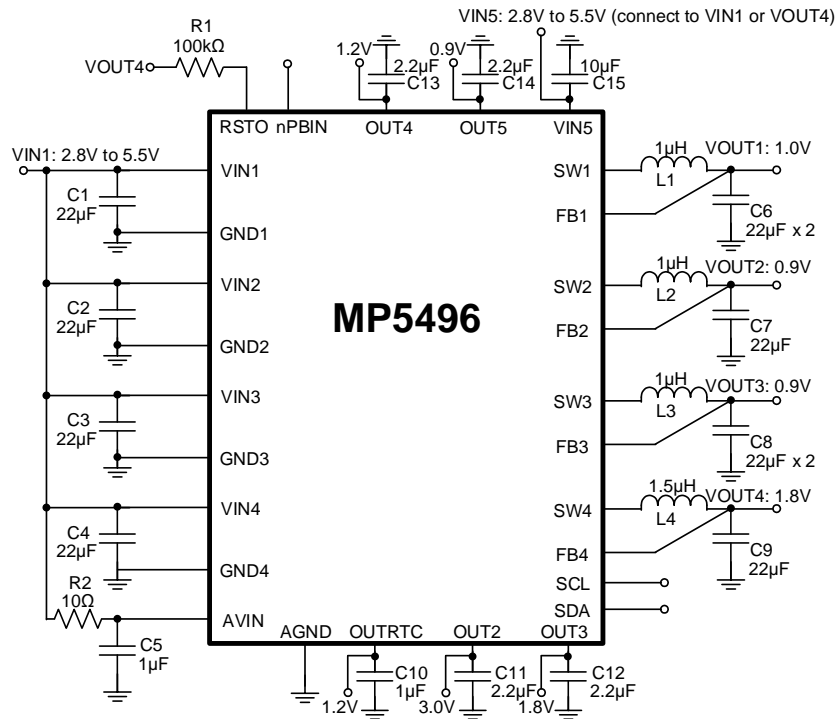
TYPICAL APPLICATION

OTP E-Fuse Selected Table by Default (MP5496GR-0001)

OTP Items	Buck 1	Buck 2	Buck 3	Buck 4	LDORTC	LDO2	LDO3	LDO4	LDO5
Output voltage	1.0V	0.9V	0.9V	1.8V	1.2V	3V	1.8V	1.2V	0.9V
Initial on/off	On	On	On	On	On	On	Off	On	On
Mode	FPWM	FPWM	FPWM	FPWM	N/A				
Start-up delay/time slot #	0ms/0	4ms/2	2ms/1	6ms/3	Always on	12ms/6	2ms/1	8ms/4	10ms/5
Automatic start-up	Yes								
Switching frequency	1.5MHz								
Push-button timer	2 seconds								
RSTO delay	100ms								
Buck 1 peak current limit	6.8A								
Buck 3 peak current limit	5.6A								
I ² C slave address	0x69								
OTP version	0004								

Other Parameter Information for the MP5496GR-0001

	Buck 1	Buck 2	Buck 3	Buck 4	LDORTC	LDO2	LDO3	LDO4	LDO5
Minimum input voltage	3V								
Typical input voltage	3.3V								
Maximum input voltage	3.6V								

ORDERING INFORMATION

Part Number*	Package	Top Marking	MSL Rating
MP5496GR-xxxx**	QFN-28 (4mmx4mm)	See Below	1
MP5496GR-0001	QFN-28 (4mmx4mm)	See Below	
EVKT-MP5496	Evaluation kit	N/A	

* For Tape & Reel, add suffix –Z (e.g. MP5496GR-XXXX–Z).

** “xxx” is the configuration code identifier for the register setting stored in the OTP. The default number is “0001”. Each “x” can be a hexadecimal value between 0 and F. Work with an MPS FAE to create this unique number, even if ordering the “0001” code. MP5496GR-0001 is the default version.

TOP MARKING

MPSYWW
MP5496
LLLLLL

MPS: MPS prefix
 Y: Year code
 WW: Week code
 MP5496: Part number
 LLLLLL: Lot number

EVKT-MP5496 EVALUATION KIT

EVKT-MP5496 kit contents (items below can be ordered separately):

#	Part Number	Item	Quantity
1	EV5496-R-00B	MP5496GR-CCCC evaluation board	1
2	EVKT-USBI2C-02-BAG	Includes USB to I ² C Communication Interface device, one USB cable, and one ribbon cable	1
3	MP5496GR-CCCC	IC with default configurations	2

Order directly from MonolithicPower.com or our distributors.

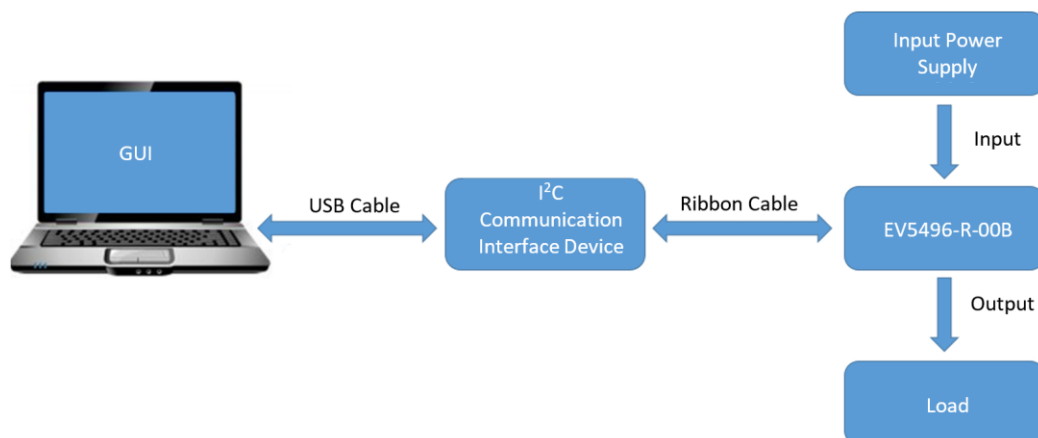
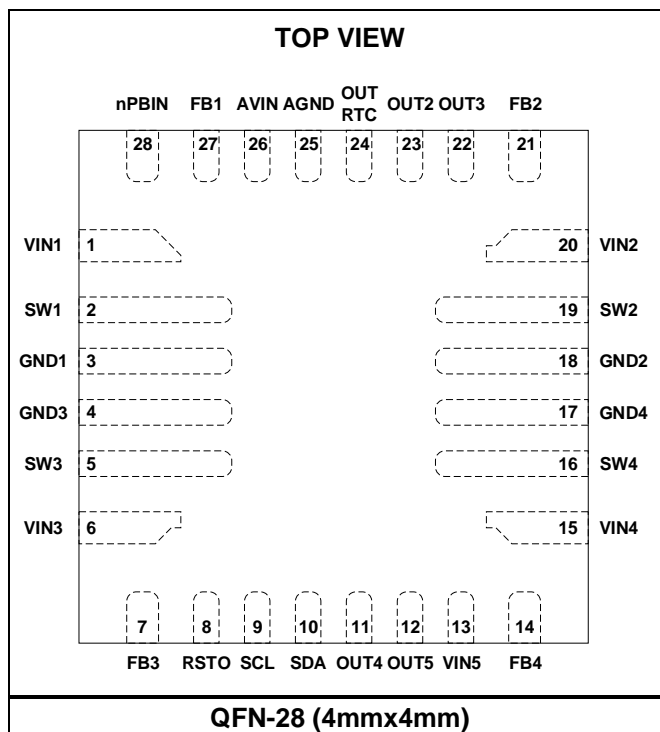

Figure 1: EVKT-MP5496 Evaluation Kit Set-Up

PACKAGE REFERENCE



PIN FUNCTIONS

Pin #	Name	Description
1	VIN1	Buck 1 supply voltage input. The MP5496 operates from a 2.8V to 5.5V input rail. A ceramic capacitor is required to decouple the input rail. Connect VIN1 using a wide PCB trace. VIN1, VIN2, VIN3, VIN4, and AVIN must be connected to the same bus voltage.
2	SW1	Buck 1 switch output. Connect SW1 using a wide PCB trace.
3	GND1	Buck 1 power ground. GND1 requires special consideration when designing the PCB layout. Connect GND1 to GND with copper traces and vias.
4	GND3	Buck 3 power ground. GND3 requires special consideration when designing the PCB layout. Connect GND3 to GND with copper traces and vias.
5	SW3	Buck 3 switch output. Connect SW3 using a wide PCB trace.
6	VIN3	Buck 3 supply voltage input. The MP5496 operates from a 2.8V to 5.5V input rail. A ceramic capacitor is required to decouple the input rail. Connect VIN3 using a wide PCB trace.
7	FB3	Buck 3 feedback. Connect the output of buck 3 directly to FB3.
8	RSTO	PMIC to CPU output reset. Once the buck 4 output is ready, the RSTO goes high after a delay. RSTO is an open-drain output that requires an external pull-up resistor.
9	SCL	I²C clock signal input. Use an external resistor to pull SCL up to AVIN if I ² C functionality is not used.
10	SDA	I²C data. Use an external resistor to pull SDA up to AVIN if I ² C functionality is not used.
11	OUT4	LDO4 output. LDO4 is powered by VIN5.
12	OUT5	LDO5 output. LDO5 is powered by VIN5.
13	VIN5	LDO4 and LDO5 power input.
14	FB4	Buck 4 feedback. Connect the output of buck 4 directly to FB4.
15	VIN4	Buck 4 supply voltage input. The MP5496 operates from a 2.8V to 5.5V input rail. A ceramic capacitor is required to decouple the input rail. Connect VIN4 using a wide PCB trace.
16	SW4	Buck 4 switch output. Connect SW4 using a wide PCB trace.
17	GND4	Buck 4 power ground. GND4 requires special consideration when designing the PCB layout. Connect GND4 to GND with copper traces and vias.
18	GND2	Buck 2 power ground. GND2 requires special consideration when designing the PCB layout. Connect GND2 to GND with copper traces and vias.
19	SW2	Buck 2 switch output. Connect SW2 using a wide PCB trace.
20	VIN2	Supply voltage input for buck 2, LDORTC, LDO2, and LDO3. The MP5496 operates from a 2.8V to 5.5V input rail. A ceramic capacitor is required to decouple the input rail. Connect VIN2 using a wide PCB trace.
21	FB2	Buck 2 feedback. Connect the output of buck 2 directly to FB2.
22	OUT3	LDO 3 output. LDO 3 is powered by VIN2.
23	OUT2	LDO 2 output. LDO 2 is powered by VIN2.
24	OUTRTC	RTC LDO output. This LDO is powered by VIN2. Set a sufficient output voltage to achieve a lower voltage gap between VIN2 and OUTRTC.
25	AGND	Analog ground. Connect AGND to power ground.
26	AVIN	Power supply input for logic circuitry. Bypass AVIN with a 0.1µF to 1µF ceramic capacitor to AGND. Connect AVIN to the system input.
27	FB1	Buck 1 feedback. Connect the output of buck 1 directly to FB1.
28	nPBIN	Push-button input. nPBIN is a logic input pin that can start up or shut down the device. A logic low over a preset deglitch time must be applied to nPBIN. nPBIN has a weak internal pull-up current.

ABSOLUTE MAXIMUM RATINGS ⁽¹⁾

VIN1, VIN2, VIN3, VIN4, VIN5, AVIN.....	0.3V to 6.25V
V _{SWx}	-0.6V (-5V for <10ns) to V _{IN} + 0.3V (7V for <10ns)
All other pins	-0.3V to +6.25V
Continuous power dissipation (T _A = 25°C) ⁽²⁾	2.84W
Junction temperature	150°C
Lead temperature	260°C
Storage temperature	-65°C to +150°C

ESD Ratings

Human body model (HBM)	±2000V
Charged device model (CDM).....	±750V

Recommended Operating Conditions ⁽³⁾

Step-down regulator (V _{IN})	2.8V to 5.5V
Step-down regulator (V _{OUT}).....	0.6V to 2.18V
LDO regulator (V _{OUTL})	0.8V to 3.9V
Operating junction temp (T _J) ...	-40°C to +125°C

Thermal Resistance	θ_{JA}	θ_{JC}
QFN-28 (4mmx4mm)		
JESD51-7 ⁽⁴⁾	44.....	9.... °C/W

Notes:

- 1) Exceeding these ratings may damage the device.
- 2) The maximum allowable power dissipation is a function of the maximum junction temperature, T_J (MAX), the junction-to-ambient thermal resistance, θ_{JA}, and the ambient temperature, T_A. The maximum allowable continuous power dissipation at any ambient temperature is calculated by P_D (MAX) = (T_J (MAX) - T_A) / θ_{JA}. Exceeding the maximum allowable power dissipation may produce an excessive die temperature, which can cause the regulator to go into thermal shutdown. Internal thermal shutdown circuitry protects the device from permanent damage.
- 3) The device is not guaranteed to function outside of its operating conditions.
- 4) Measured on JESD51-7, 4-layer PCB. The value of θ_{JA} given in this table is only valid for comparison with other packages and cannot be used for design purposes. These values were calculated in accordance with JESD51-7, and simulated on a specified JEDEC board. They do not represent the performance obtained in an actual application.

ELECTRICAL CHARACTERISTICS

VIN1 = VIN2 = VIN3 = VIN4 = VIN5 = AVIN = 5V, T_J = -40°C to 125°C ⁽⁵⁾, unless otherwise noted.

Parameter	Symbol	Condition	Min	Typ	Max	Units
Supply current (no switching)	I _{IN}	No switching, feedback is high, T _J = 25°C		420	500	μA
Default oscillation frequency	f _{SW}		1.2	1.5	1.8	MHz
Thermal shutdown entry threshold ⁽⁶⁾	T _{OTP_R}		145	153	162	°C
Thermal shutdown recovery threshold ⁽⁶⁾	T _{HYS}		121	130	139	°C
Step-Down Regulator						
AVIN UVLO rising	V _{AIN1_R}		2.4	2.55	2.7	V
AVIN UVLO hysteresis	V _{AIN1_HYS}			300		mV
VIN1 UVLO rising	V _{VIN1_R}			2.45		V
VIN1 UVLO hysteresis	V _{VIN1_HYS}			300		mV
VIN2 UVLO rising ⁽⁷⁾	V _{VIN2_R}			2.45		V
VIN2 UVLO hysteresis ⁽⁷⁾	V _{VIN2_HYS}			300		mV
VIN3 UVLO rising	V _{VIN3_R}			2.45		V
VIN3 UVLO hysteresis	V _{VIN3_HYS}			300		mV
VIN5 UVLO rising	V _{VIN5_R}			2.45		V
VIN5 UVLO hysteresis	V _{VIN5_HYS}			300		mV
Feedback voltage accuracy	V _{FB1}	Default output of buck 1	0.985	1	1.015	V
	V _{FB2}	Default output of buck 2	0.8865	0.9	0.9135	V
	V _{FB3}	Default output of buck 3	0.8865	0.9	0.9135	V
	V _{FB4}	Default output of buck 4	1.7730	1.8	1.8270	V
Maximum duty cycle	D _{MAX}	CH2 and CH4 only		100		%
Buck 1, Buck 3 (4.5A/4A)						
HS switch on resistance	HS _{RDS-ON1}	500mA, T _J = 25°C	10	30	50	mΩ
	HS _{RDS-ON3}					
	HS _{RDS-ON1}	500mA, T _J = -40°C to +125°C	10	30	50	mΩ
	HS _{RDS-ON3}					
LS switch on resistance	LS _{RDS-ON1}	500mA, T _J = 25°C		12	20	mΩ
	LS _{RDS-ON3}					
	LS _{RDS-ON1}	500mA, T _J = -40°C to +125°C		12	20	mΩ
	LS _{RDS-ON3}					
Switch leakage 1	HS _{WILK1}	EN = 0V, VIN = 5.5V, T _J = 25°C, SW = 0V or 5.5V		0	1	μA
	HS _{WILK3}					
Switch leakage 2	LS _{WILK1}	EN = 0V, VIN = 5.5V, T _J = 25°C, SW = 0V or 5.5V		0	1	μA
	LS _{WILK3}					
High-side current limit	I _{LIMIT1}	Under 20% duty cycle, T _J = 25°C	5.5	6.8	8.3	A
	I _{LIMIT3}		4.5	5.6	7	A

ELECTRICAL CHARACTERISTICS (continued)
VIN1 = VIN2 = VIN3 = VIN4 = VIN5 = AVIN = 5V, T_J = -40°C to +125°C ⁽⁵⁾, unless otherwise noted.

Parameter	Symbol	Condition	Min	Typ	Max	Units
Minimum on time ⁽⁸⁾	t _{ON_MIN1}			40		ns
	t _{ON_MIN3}			33		ns
Minimum off time ⁽⁸⁾	t _{OFF_MIN1}			120		ns
	t _{OFF_MIN3}			120		ns
Output discharge resistance	R _{O_DIS1}			7		Ω
Soft-start time	t _{SS_B1}	V _{OUT} = 10% to 90%		450		μs
	t _{SS_B3}	V _{OUT} = 10% to 90%		450		μs
Buck 2, Buck 4 (2.5A/2A)						
HS switch on resistance	HS _{RDS-ON2}	500mA, T _J = 25°C	20	50	80	mΩ
	HS _{RDS-ON4}					
	HS _{RDS-ON2}	500mA, T _J = -40°C to 125°C	20	50	80	mΩ
	HS _{RDS-ON4}					
LS switch on resistance	LS _{RDS-ON2}	500mA, T _J = 25°C		65	105	mΩ
	LS _{RDS-ON4}					
	LS _{RDS-ON2}	500mA, T _J = -40°C to 125°C		65	105	mΩ
	LS _{RDS-ON4}					
Switch leakage 3	HS _{WILK2}	Shutdown, V _{IN} = 5.5V, SW = 0V or 5.5V, T _A = 25°C		0	1	μA
	HS _{WILK4}					
Switch leakage 4	LS _{WILK2}	Shutdown, V _{IN} = 5.5V, SW = 0V or 5.5V, T _A = 25°C		0	1	μA
	LS _{WILK4}					
High-side current limit	I _{LIMIT2}	Under 20% duty cycle, T _J = 25°C	3	4.2	5.4	A
	I _{LIMIT4}					
Minimum on time ⁽⁸⁾	t _{ON_MIN2}			32		ns
	t _{ON_MIN4}			32		ns
Minimum off time ⁽⁸⁾	t _{OFF_MIN2}			100		ns
	t _{OFF_MIN4}			100		ns
Output discharge resistance	R _{O_DIS2}			7		Ω
Soft-start time	t _{SS_B2}	V _{OUT} = 10 to 90%		450		μs
	t _{SS_B4}	V _{OUT} = 10 to 90%		450		μs
10mA RTC LDO						
Default output voltage	V _{RTC_LDO}	I _{OUT} = 10mA, power-on state	1.164	1.2	1.236	V
Ground current	I _{Q_RTC}	No load		6.5		μA
Dropout voltage ⁽⁸⁾	V _{DROP1}	V _{OUT} = 3V, I _{OUT} = 10mA		100		mV
Current limit	I _{LIM_RTC}	V _{IN} = 3.3V, V _{OUT} drops 33%, T _J = 25°C	25	55	85	mA
Soft-start slew rate	t _{SS_RTC}	V _{OUT} = 10% to 90%, C _{OUT} = 1μF		35		mV/μs

ELECTRICAL CHARACTERISTICS (continued)
VIN1 = VIN2 = VIN3 = VIN4 = VIN5 = AVIN = 5V, T_J = -40°C to +125°C ⁽⁵⁾, unless otherwise noted.

Parameter	Symbol	Condition	Min	Typ	Max	Units
Low-Dropout (LDO) Regulator: LDO2 to LDO5						
Output voltage	V _{LDO2}		2.940	3.00	3.060	V
	V _{LDO3}		1.764	1.80	1.836	V
	V _{LDO4}		1.176	1.20	1.224	V
	V _{LDO5}		0.882	0.90	0.918	V
PSRR ⁽⁸⁾	PSRR _{1k}	f _{sw} = 1kHz, 100mA, V _{OUT} = 1.8V		47		dB
	PSRR _{10k}	f _{sw} = 10kHz, 100mA, V _{OUT} = 1.8V		51		dB
Dropout voltage	V _{DROP1}	V _{OUT} = 3V, I _{OUT} = 300mA		100		mV
Current limit	I _{LIMIT_LDO}	VIN = 3.3V, V _{OUT} drops 33%	320	430	640	mA
Output discharge resistance	R _{O_DIS2}			7		Ω
Soft-start time	t _{SS_B2}	V _{OUT} = 10% to 90%, C _{OUT} = 2.2μF		70		μs
Line regulation		VIN2 = VIN5 = 2.8V to 5.5V		0.3		%/V
Load regulation		VIN2 = VIN5 = 3.3V, I _{OUT} from 10mA to 100mA		0.5		%
Logic Pins						
nPBIN pull-up current	I _{PBIN}	Internal pull-up to AVIN	5	9	13	μA
Push-button detection threshold	V _{PB}		500	700	900	mV
Manual reset threshold	V _{MS}	nPBIN pulls low, T _J = 25°C			50	mV
RSTO rising threshold	V _{RSTO_R}	Monitor buck 4's output		90%		V _{FB4}
RSTO falling threshold	V _{RSTO_F}			80%		V _{FB4}
RSTO rising delay	t _{RSTO}	Adjustable through I ² C/OTP	70	100	130	ms
I²C Interface Specifications ⁽⁹⁾						
Input logic high	V _{IH}		1.4			V
Input logic low	V _{IL}				0.4	V
Output voltage logic low	V _{OUT_L}	RSTO pin sink 4mA			0.4	V
SCL clock frequency	f _{SCL}				3.4	MHz
SCL high time	t _{HIGH}		60			ns
SCL low time	t _{LOW}		160			ns
Data set-up time	t _{SUDAT}		10			ns
Data hold time	t _{HDDAT}			70		ns
Set-up time for repeated start condition	t _{SUSTA}		160			ns
Hold time for repeated start condition	t _{HDSTA}		160			ns
Bus free time between a start and stop condition	t _{BUF}		160			ns
Set-up time for stop condition	t _{SUSTO}		160			ns

ELECTRICAL CHARACTERISTICS *(continued)*

VIN1 = VIN2 = VIN3 = VIN4 = VIN5 = AVIN = 5V, T_J = -40°C to +125°C ⁽⁵⁾, unless otherwise noted.

Parameter	Symbol	Condition	Min	Typ	Max	Units
SCL and SDA rise time	t _R		10		300	ns
SCL and SDA fall time	t _F		10		300	ns
Pulse width of suppressed spike	t _{SP}		0		50	ns
Capacitance bus for each bus line	C _B				400	pF
SCL low time	t _{LOW}		160			ns

Notes:

- 5) Not tested in production. Guaranteed by over-temperature correlation.
- 6) Guaranteed by design.
- 7) VIN2 and VIN4 share the same UVLO threshold. It is recommended to connect VIN2 and VIN4 together in applications.
- 8) Guaranteed by engineering sample characterization.
- 9) See the I²C Timing Diagram below when reading the I²C interface specifications. It is recommended to begin operating the I²C after the power-on sequence is finished, or RSTO switches high.

I²C TIMING DIAGRAM

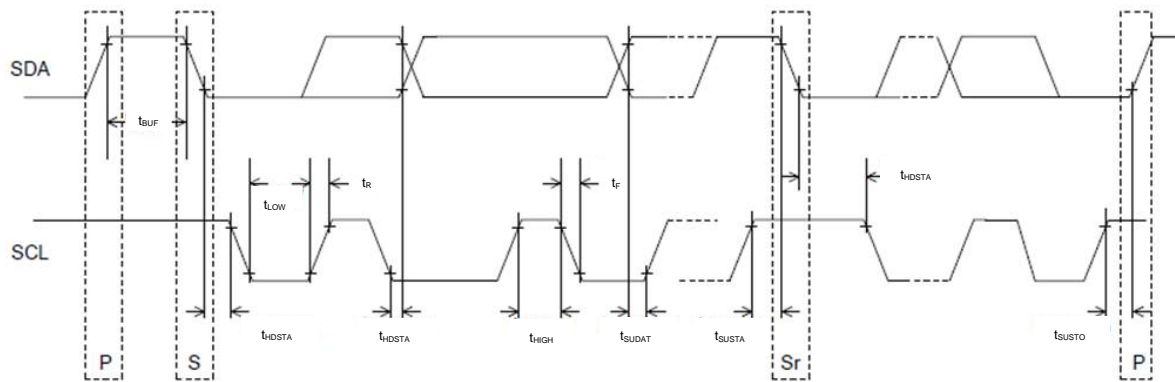

Figure 2: I²C Timing Diagram

TYPICAL CHARACTERISTICS

Performance waveforms are tested on the evaluation board. $V_{IN} = 3.3V$, $T_A = 25^\circ C$, tested using MP5496GR-0001 specified parts, unless otherwise noted.

Efficiency vs. Load Current

$f_{sw} = 1.5MHz$, PWM mode,
L1-3 DCR = 4.6m Ω , L4 DCR = 6.6m Ω

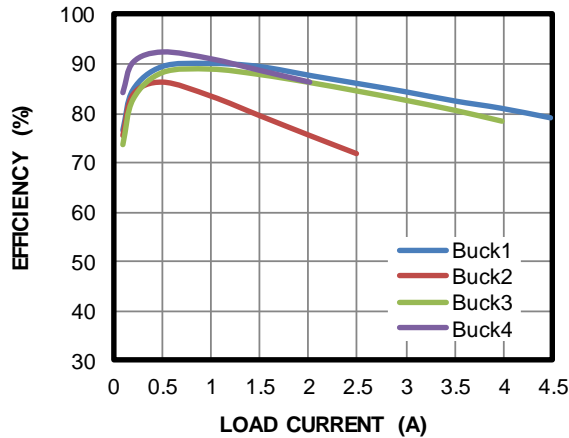

Load Regulation vs. Load Current

$f_{sw} = 1.5MHz$, PWM mode

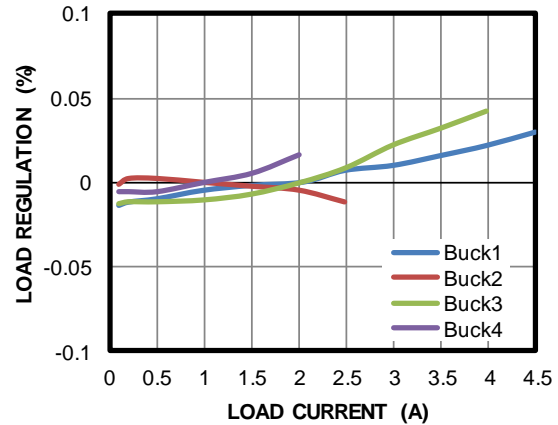

Current Limit vs. Input Voltage

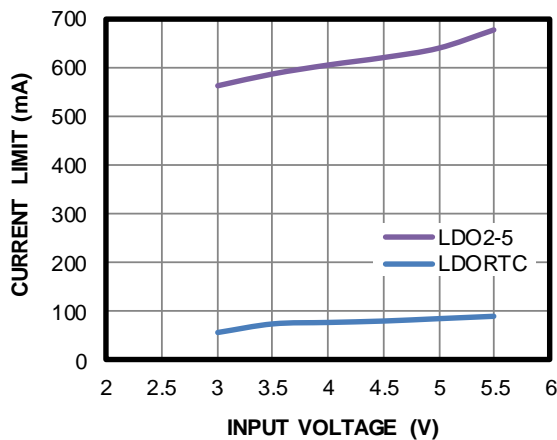

Quiescent Current vs. Input Voltage

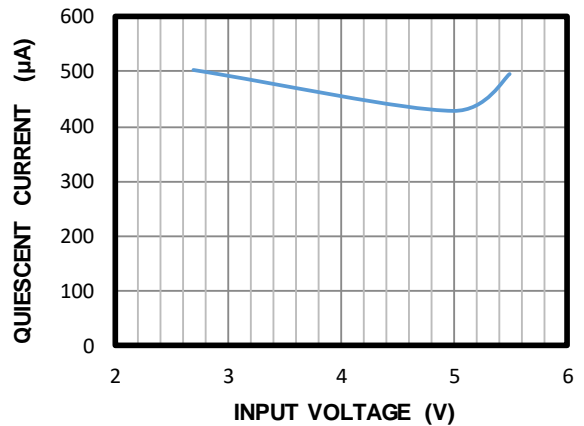

V_{IN} Threshold vs. Temperature

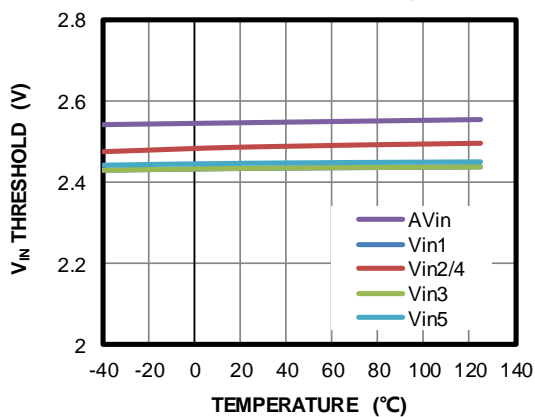

Switching Frequency vs. Temp

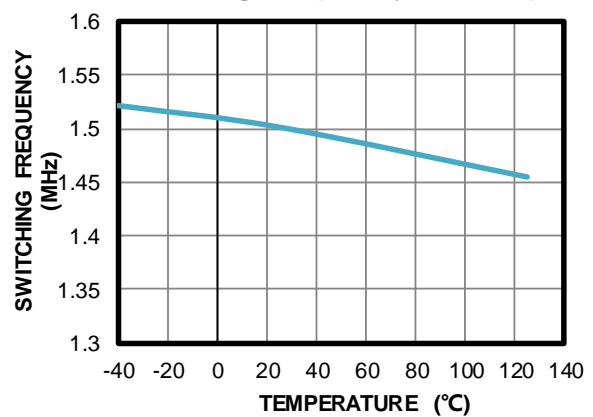

TYPICAL PERFORMANCE CHARACTERISTICS

Performance waveforms are tested on the evaluation board. $V_{IN} = 3.3V$, $T_A = 25^\circ C$, tested using MP5496GR-0001 specified parts, unless otherwise noted.

Steady State

$V_{IN} = 3.3V$, each channel buck with no load

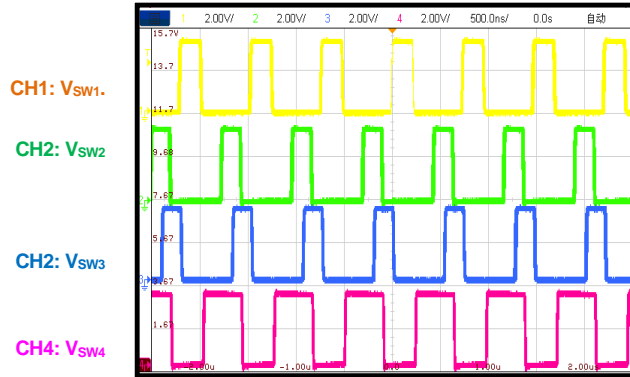

Steady State

$V_{IN} = 3.3V$, each channel buck with full load

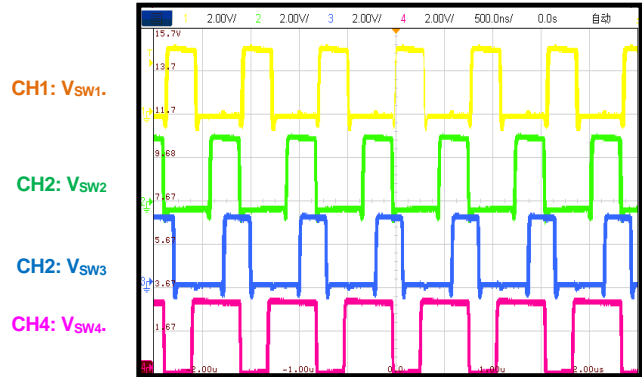

Start-Up

$V_{IN} = 3.3V$, $I_{BUCK1} = 0A$

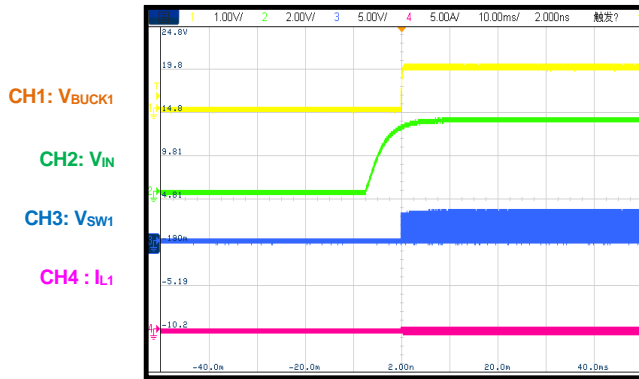

Start-Up

$V_{IN} = 3.3V$, $I_{BUCK1} = 4.5A$

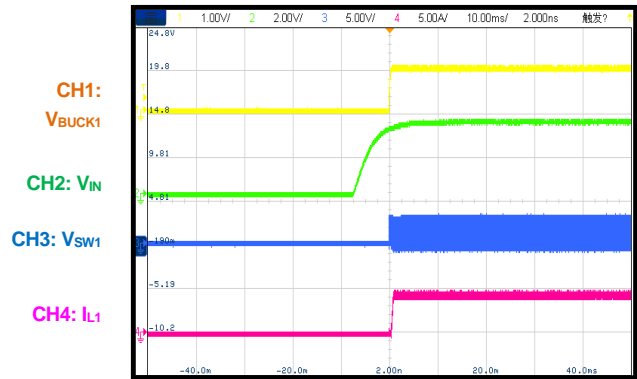

Shutdown

$V_{IN} = 3.3V$, $I_{BUCK1} = 0A$

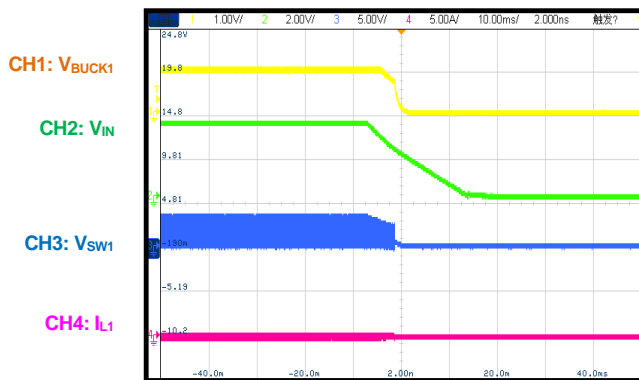

Shutdown

$V_{IN} = 3.3V$, $I_{BUCK1} = 4.5A$

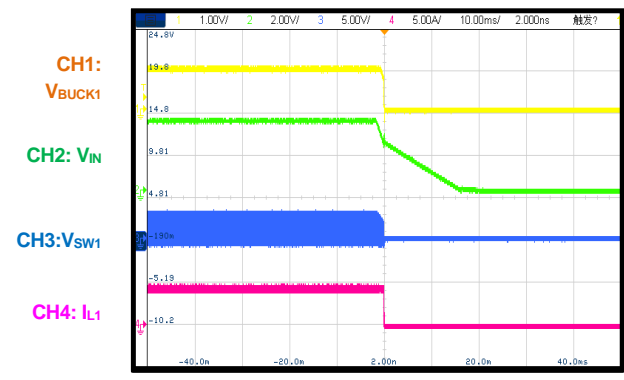

TYPICAL PERFORMANCE CHARACTERISTICS *(continued)*

Performance waveforms are tested on the evaluation board. $V_{IN} = 3.3V$, $T_A = 25^\circ C$, tested using MP5496GR-0001 specified parts, unless otherwise noted.

Load Transient
 $I_{OUT} = 0$ to $4.5A$, $2.5A/\mu s$

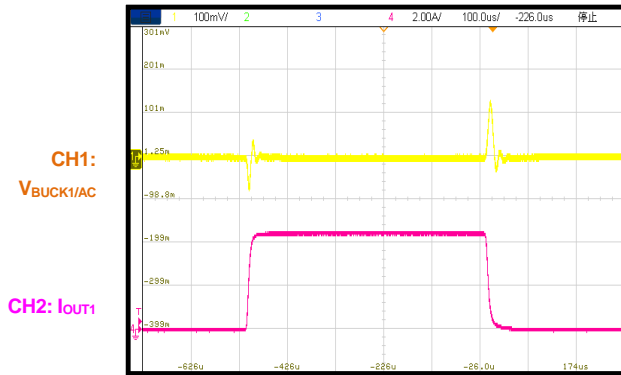

Load Transient
 $I_{OUT} = 0$ to $2A$, $2.5A/\mu s$

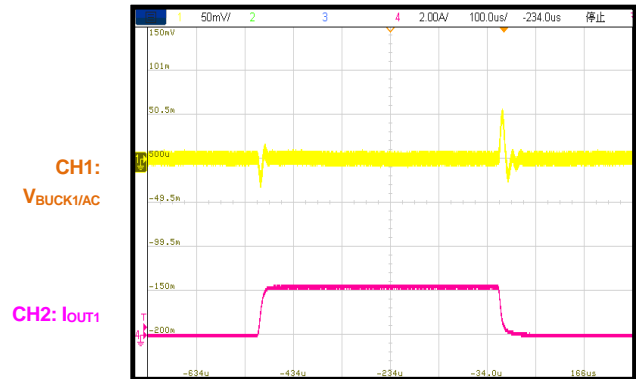

Load Transient
 $I_{OUT} = 2A$ to $4.5A$, $2.5A/\mu s$

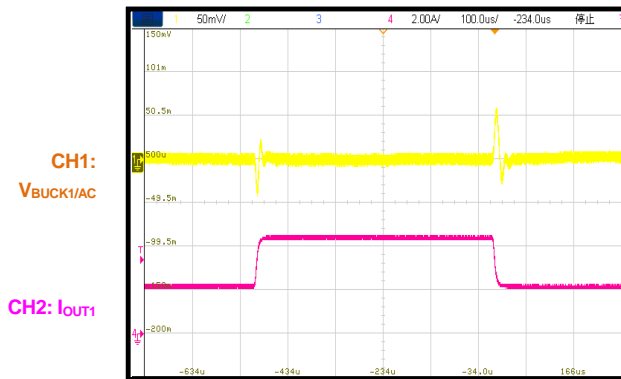

nPBIN Start-Up
 Each channel with no load

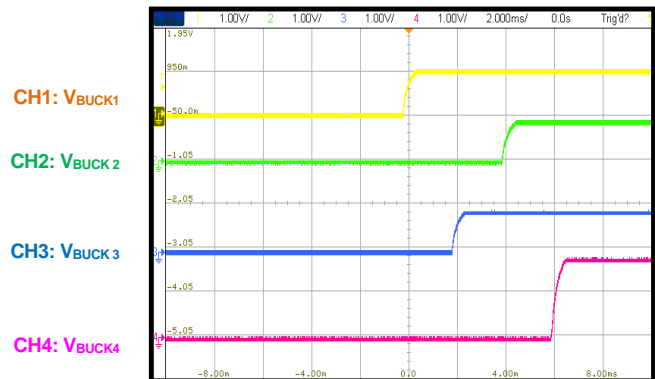

nPBIN Start-Up
 Each channel with no load

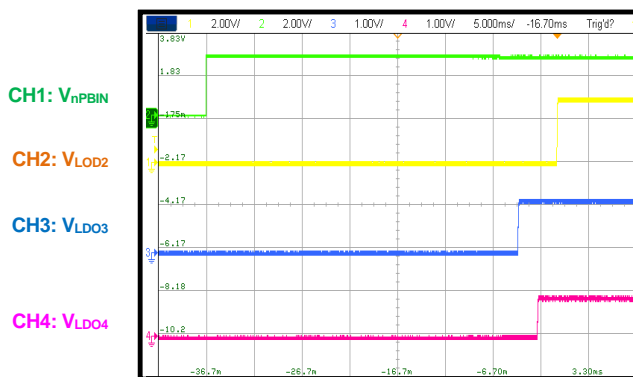

nPBIN Shutdown
 Each channel with no load

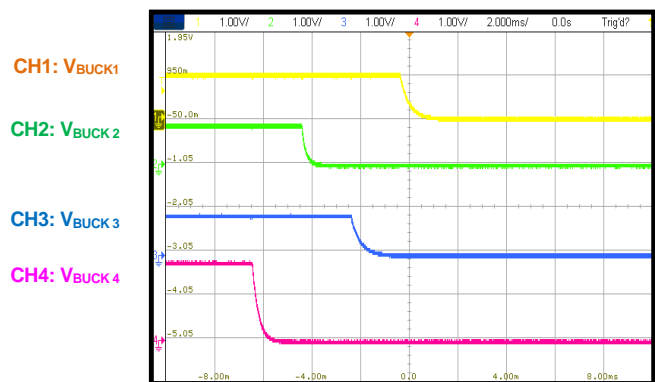

TYPICAL PERFORMANCE CHARACTERISTICS *(continued)*

Performance waveforms are tested on the evaluation board. $V_{IN} = 3.3V$, $T_A = 25^\circ C$, tested using MP5496GR-0001 specified parts, unless otherwise noted.

nPBIN Shutdown

Each channel with no load

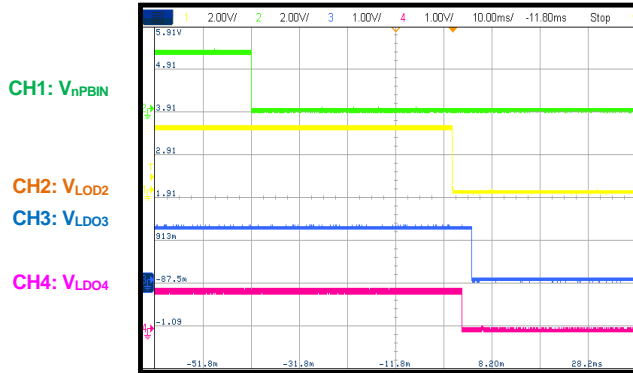

SCP Entry

SCP entry, no load

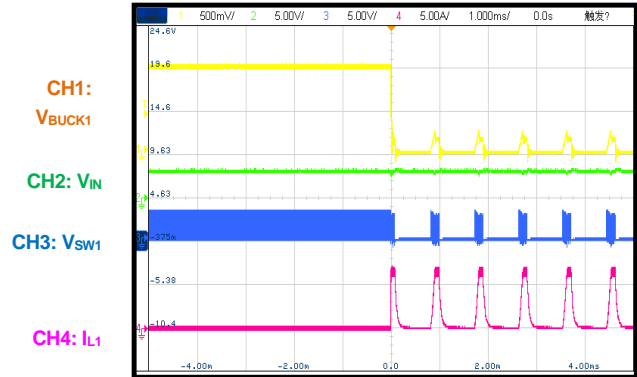

SCP Steady State

SCP steady state, no load

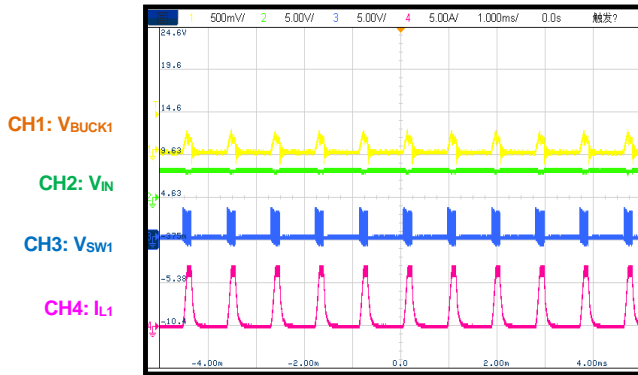

SCP Recovery

SCP recovery, no load

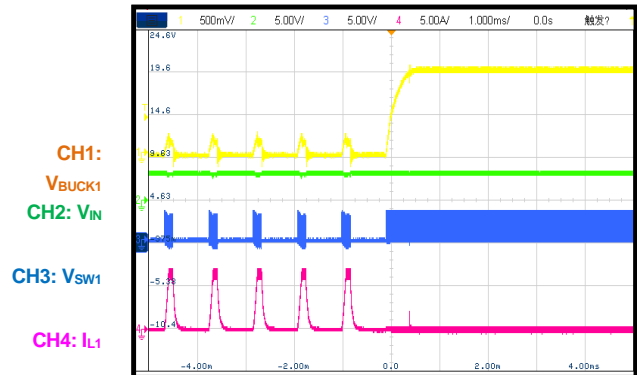

SCP Entry

SCP entry, full load

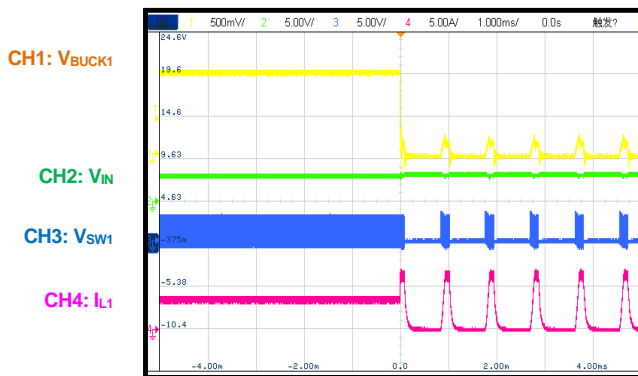

SCP Steady State

SCP steady state, full load

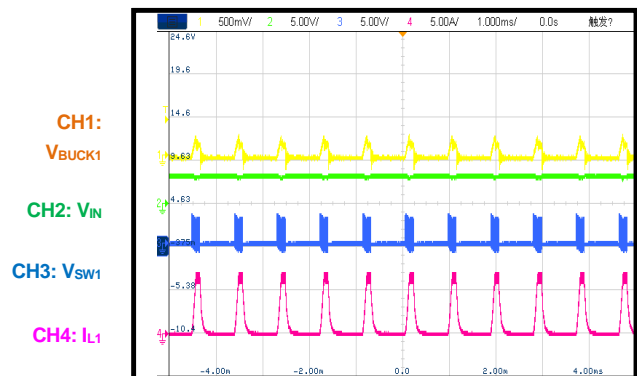

TYPICAL PERFORMANCE CHARACTERISTICS *(continued)*

Performance waveforms are tested on the evaluation board. $V_{IN} = 3.3V$, $T_A = 25^\circ C$, tested using MP5496GR-0001 specified parts, unless otherwise noted.

SCP Recovery

SCP recovery, full load

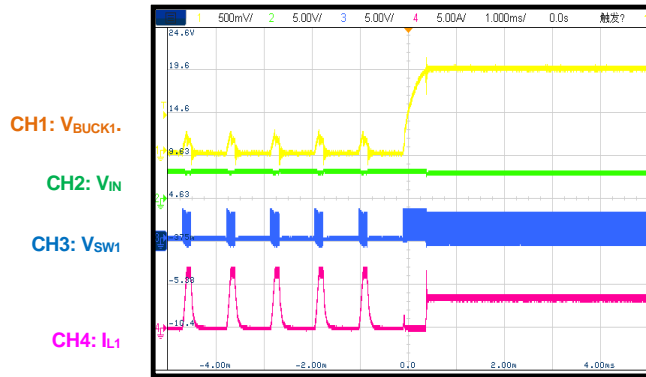

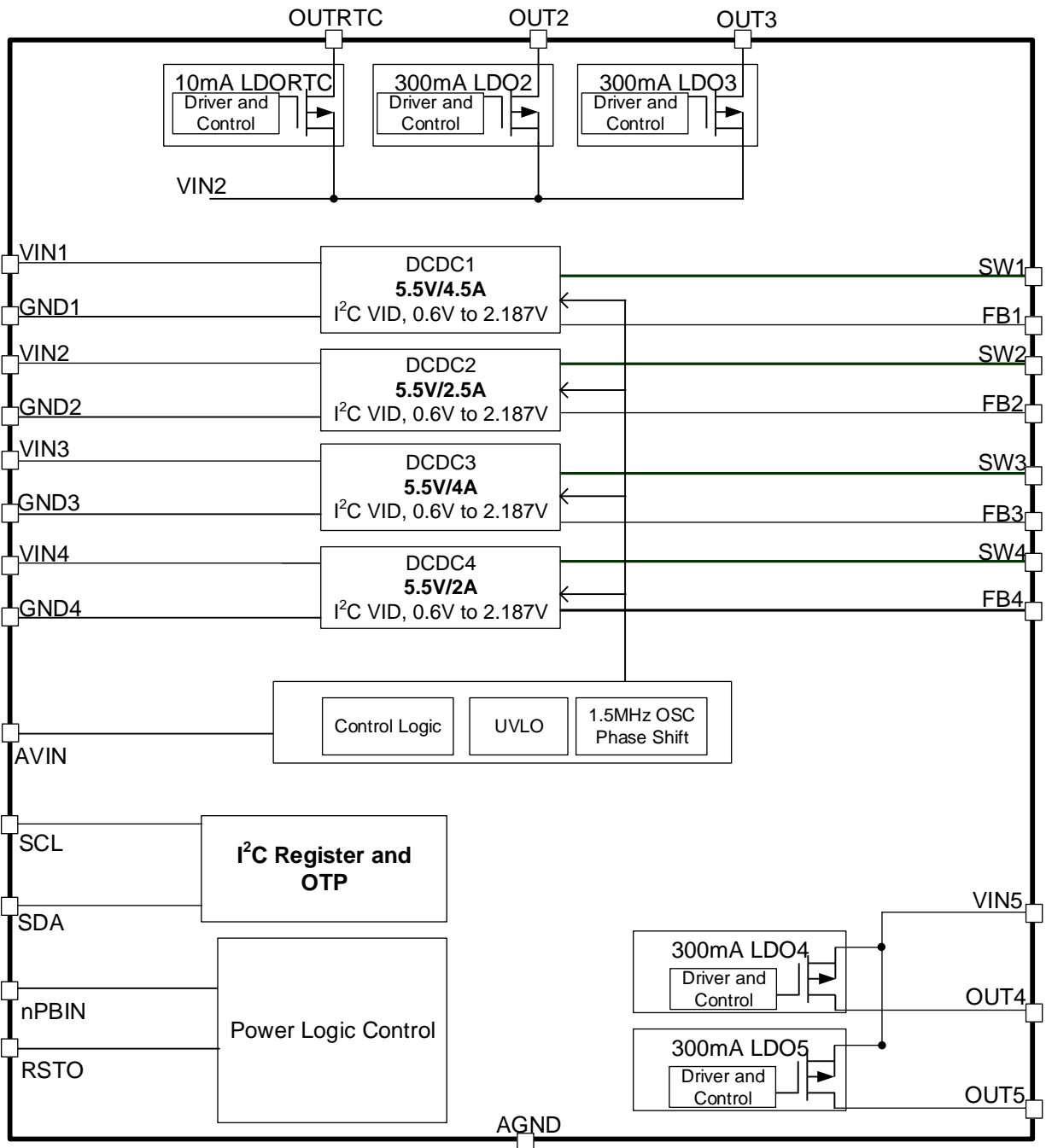
FUNCTIONAL BLOCK DIAGRAM

Figure 3: Functional Block Diagram

OPERATION

The MP5496 provides a complete power management solution for many 5V systems, such as televisions, SSDs, and STBs. The MP5496 integrates four high-frequency, synchronous, rectified, step-down switch-mode converters and five low-dropout regulators. The MP5496 greatly reduces PCB space and the number of external components. The MP5496 can manage the power system for either a

single-cell Li-ion battery or a 5V regulated input voltage, allowing for greater flexibility of the system design.

The I²C interface and one-time programmable (OTP) memory interfaces provide an adjustable default output voltage and dynamic voltage scaling. The I²C also provides powerful logic functions. See the Register Map section starting on page 27 for more details.

POWER CONTROL

State Machine Diagram

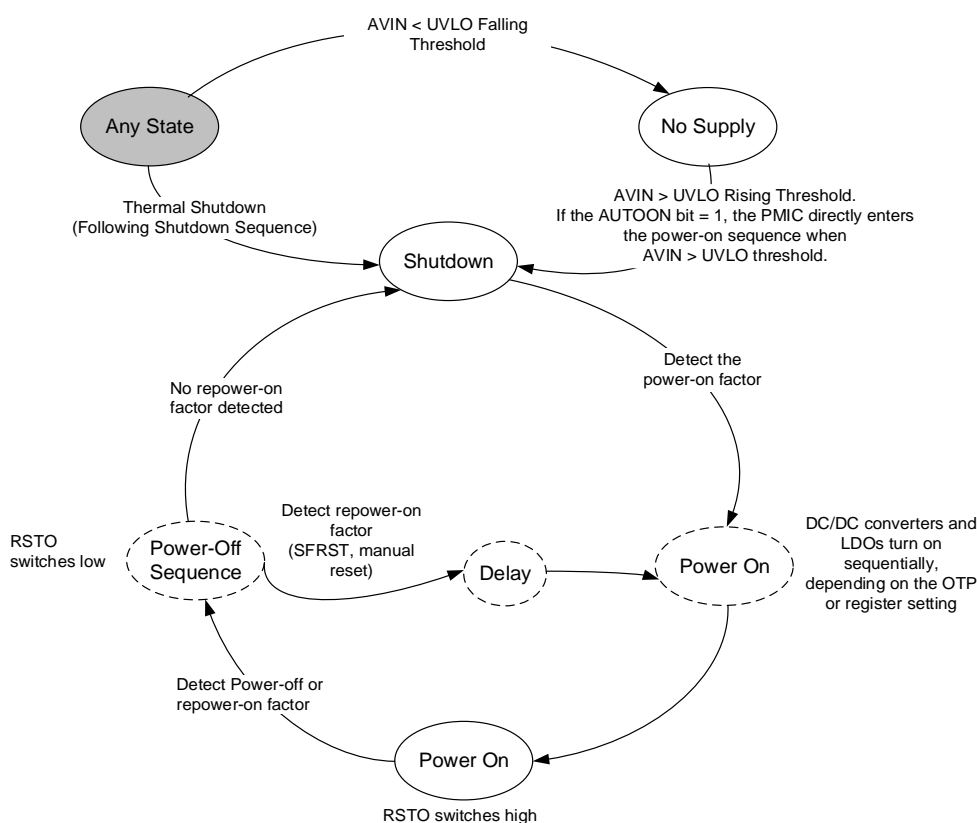

Figure 4: Power Control State Machine Diagram

State Machine Description

Figure 4 shows the state machine, which has multiple features. These features are described below.

No Supply

The PMIC’s input pin has an under-voltage lockout (UVLO) detection circuit. If the input voltage (AVIN) is below the UVLO rising threshold, the PMIC’s functions are disabled.

Power Off

If AVIN exceeds its rising UVLO threshold and the AUTOON bit = 0, the PMIC first enters a power-off state. In this state, the PMIC always monitors the power-on factor. Once the power-on factor is detected, the device initiates the power-on sequence.

Power-On Sequence

The DC/DC converters and LDO regulators turn on sequentially according to the preconfigured order via the OTP e-fuse.

Power-On

The DC/DC converters and LDO regulators turn on. The RSTO output switches high. In this state, the PMIC always monitors the power-off or repower-on factors.

Power-Off Sequence

The PMIC enters the power-off sequence if it detects the power-off or repower-on factors while in the power-on state. First RSTO switches low, and then the DC/DC converters and LDO regulators turn off sequentially in the reverse order of the power-on sequence. After the power-off sequence is completed, the repower-on condition (software control) is monitored. Then the PMIC enters the power-on sequence automatically after a delay timer.

Shutdown Event

If the PMIC detects that the input voltage is below the UVLO falling threshold (the device enters a no supply state) or over-temperature protection is triggered (the device enters a power-off state), the PMIC switches to a no supply state or power-off state, regardless of the current state. ⁽¹⁰⁾

Note:

10) If PMIC enters a power-off state due to over-temperature protection, LDORTC is off.

Power-On Factors

The PMIC has three power-on factors, described below.

SYSEN

SYSEN is one data bit in the I²C register. If the SYSEN bit is set to 1, the system changes from a power-off state and initiates the power-on sequence. Two methods can set SYSEN from 0 to 1. The first method is by setting the AUTOON bit to 1 via the OTP. With this method, the system auto-loads the AUTOON bit into SYSEN when the input voltage exceeds the UVLO threshold. The second method is by using the push button to initiate a power-on sequence.

nPBIN On

nPBIN on includes two kinds of push-button events. If the nPBIN pin is pulled to logic low (but is not pulled to ground) and asserts low for longer than 2 seconds, the PMIC treats this as a power-on factor. If nPBIN is pulled to ground (below the manual reset threshold) in the power-off state, and asserts for longer than the maximum 30ms debounce time, the PMIC also treats this as a power-on factor. The SYSEN bit is set high if any of the nPBIN-initiated power-on events described above are detected.

Thermal Recovery

If the MP5496 is in a power-off state because the die temperature has exceeded the thermal protection threshold, the PMIC enters a power-on sequence once the die's temperature decreases.

Power-On Sequence

There are eight slots for power-on sequence timing (see Figure 5). All the DC/DC converters and LDO regulators (except RTCLDO) can be configured to time slots 0 through 7 by the OTP e-fuse. The delay time between each time slot is related to the default switching frequency of the MP5496 (see Table 1).

Table 1: Slot Time Interval vs. Default Switching Frequency

Default Switching Frequency	Time Delay between Each Slot
1.0MHz	3ms
1.5MHz	2ms
2.0MHz	1.5ms
2.5MHz	1.2ms

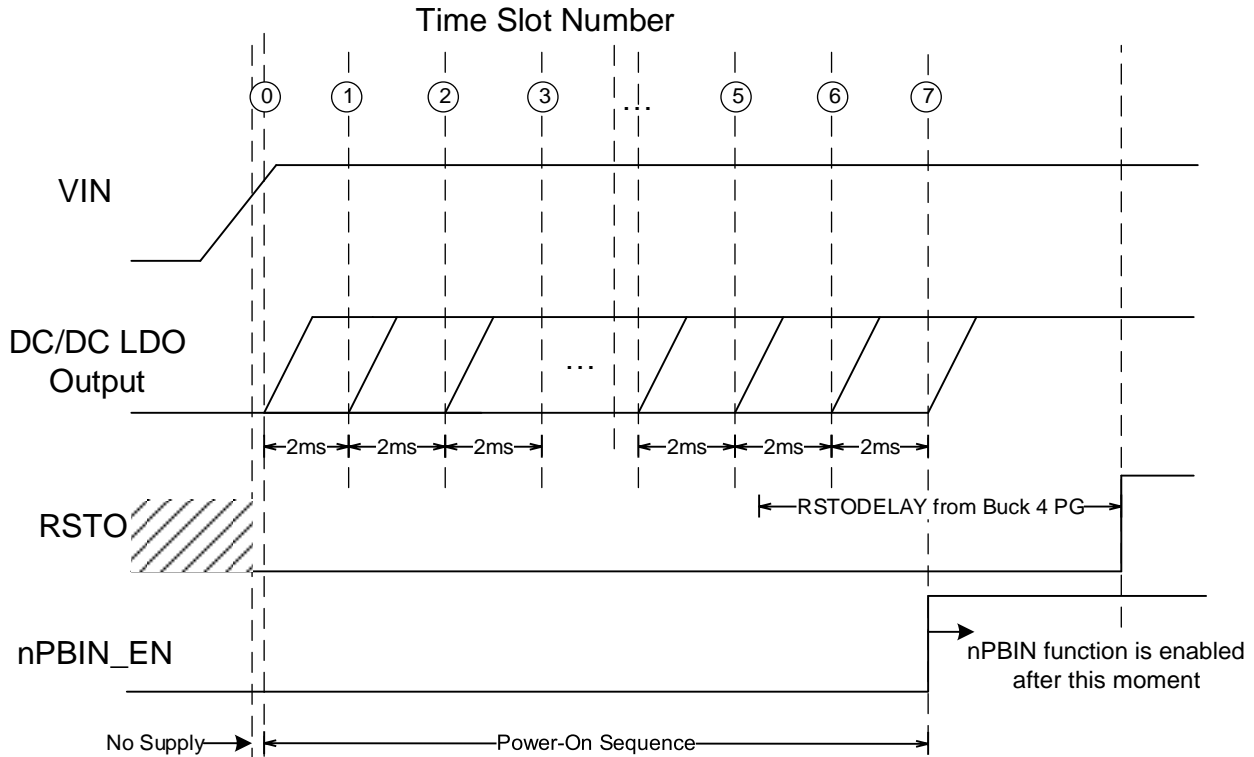

Figure 5: Power-On Sequence (AUTOON Bit is Set to 1)

OUTRTC On

The OUTRTC LDO turns on if both VIN2 and AVIN exceed their respective UVLO rising thresholds, regardless of any other pin’s status. OUTRTC turns off if either VIN2 or AVIN falls below its respective UVLO falling thresholds, or if thermal shutdown is triggered.

Other Buck Regulators and LDOs On

The MP5496 provides a configurable power-on sequence. If the power-on sequence is fixed, the power-off sequence is reversed. See the OTP Register Description section on page 27 to determine which bits set the time slot number for each channel.

Power-Off Factors

nPBIN Long Press

If nPBIN is pulled to logic low (but not pulled to ground) and asserts longer than 8 seconds, the PMIC enters the power-off sequence.

nPBIN Short Press

If nPBIN is pulled to GND (below the manual reset threshold) and lasts longer than the maximum 30ms debounce time, the PMIC enters the power-off sequence after an 8ms delay time (see Figure 8).

SYSEN (Software-Initiated Shutdown)

The MP5496 supports a software-controlled shutdown through the I²C interface. SYSEN is one data bit in the I²C register. If the SYSEN bit is set to 0, the system enters a power-off sequence. To restart the PMIC, toggle the input power supply or use the nPBIN function (see the nPBIN Functions section on page 22 for more details).

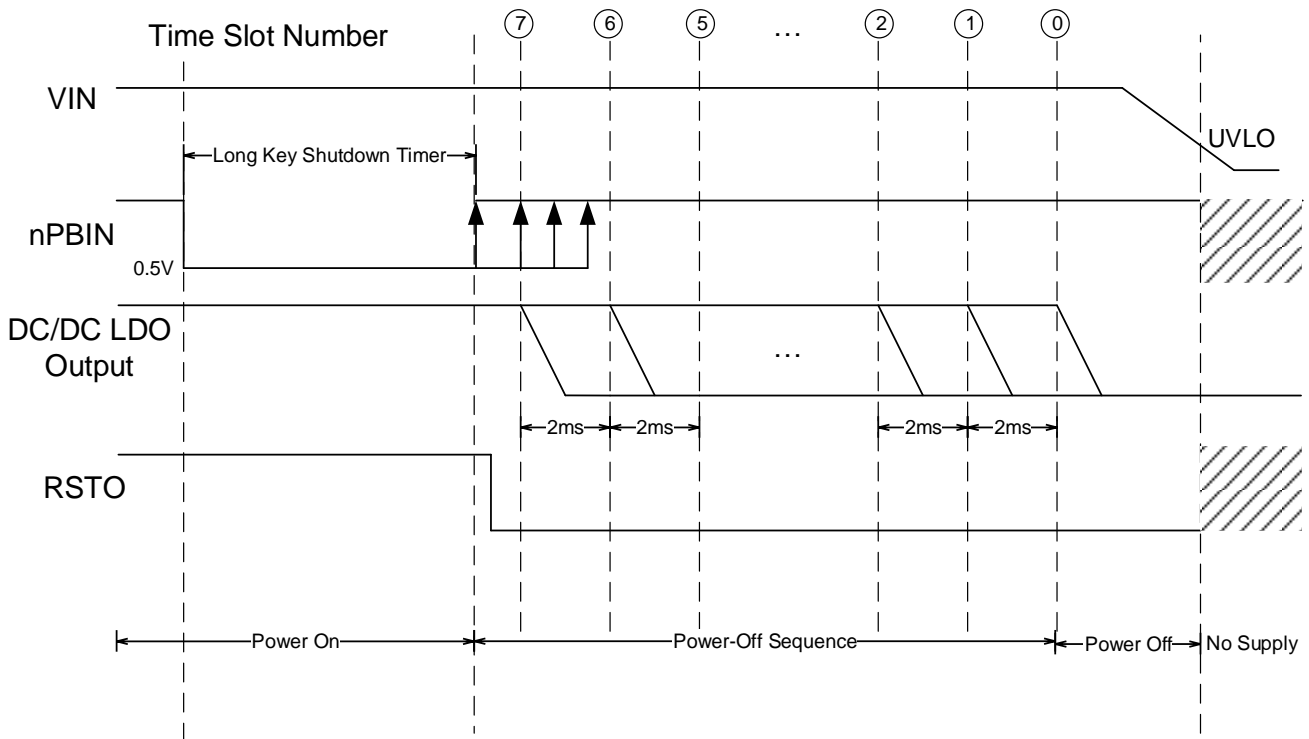

Figure 6: Power-Off Sequence via nPBIN Pin Press

Power-Off Sequence

RSTO is pulled low before the DC/DC converter or LDO regulator turns off (see Figure 6). The DC/DC converter and LDO regulator power-off sequence is in the reverse order of the power-on sequence.

Repower-On Factors

Manual Reset

To manually reset the device, pull the nPBIN pin to ground (below the manual reset threshold) for longer than the maximum 30ms debounce time. It is released after a set time (see Figure 8).

SFRST

Software reset. If the SFRST bit is set to 1 through the I²C interface, the system detects this as a repower-on factor.

Repower-On Sequence (Software-Initiated Power Cycle)

The MP5496 supports a software-controlled power reset through the I²C interface or a manual reset push button.

When using the software-controlled method, the SFRST bit is set high. The MP5496 waits for 8ms and powers off the system, then powers on all of the power rails after a 60ms delay. The SFRST bit is automatically reset to 0 by the RSTO rising edge. After the SFRST bit is reset to 0, the software can control power cycle again. Repower-on factor detection is blocked during the repower-on period (t1 to t2) (see Figure 7).

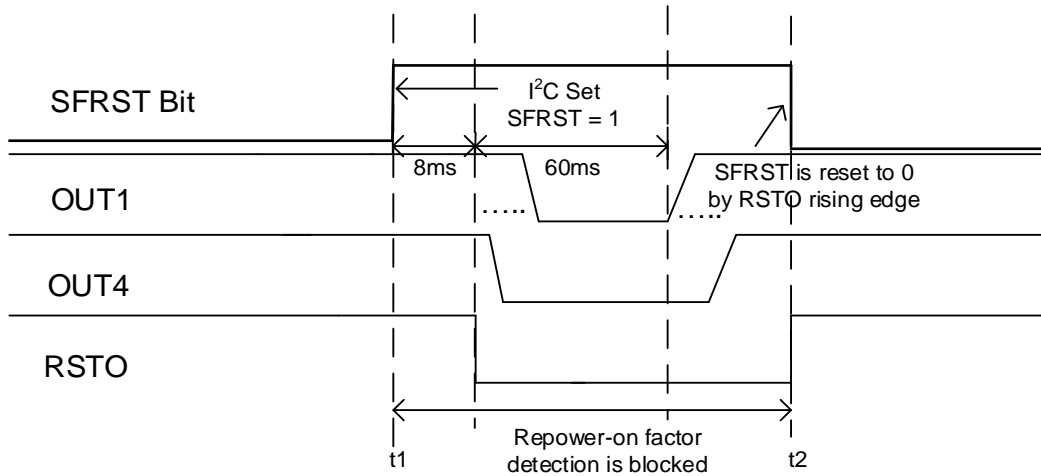

Figure 7: Repower-On Sequence (Software Control)

If the PMIC is working in a power-on state when using the manual reset control method, and the manual reset button is pressed down, the PMIC enters a power-off sequence. It enters this sequence after a maximum 30ms debounce time and 8ms of delay, then remains in the power-off state until the manual reset button is released. After a 30ms debounce time, the PMIC enters the power-on sequence again, and the manual reset function is also completed (see Figure 8).

Shutdown Sequence

If the input voltage drops below the UVLO falling threshold, or the IC experiences an over-temperature condition, the PMIC immediately enters the shutdown sequence. All DC/DC converters and LDO regulators turn off at the same time (see Figure 9).

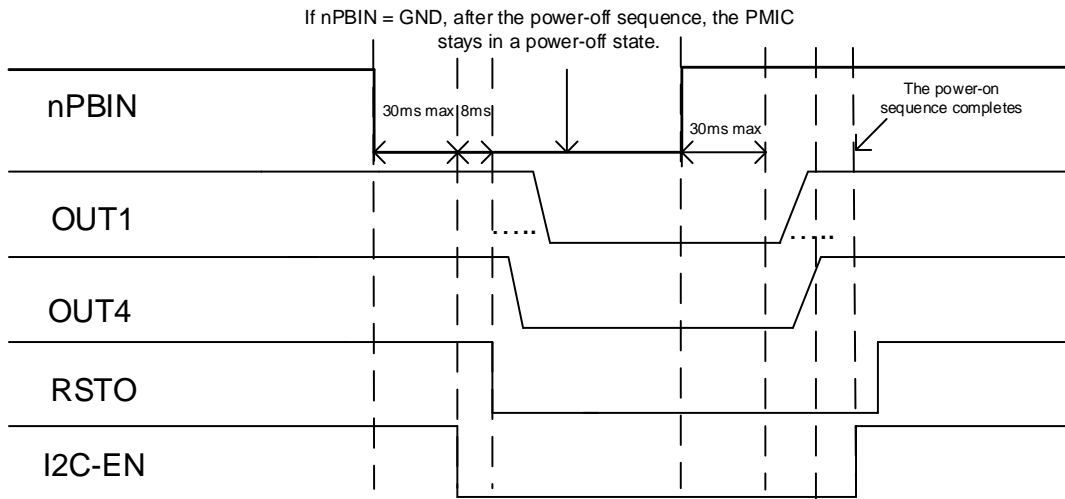

Figure 8: Repower-On Sequence (Manual Reset Control)

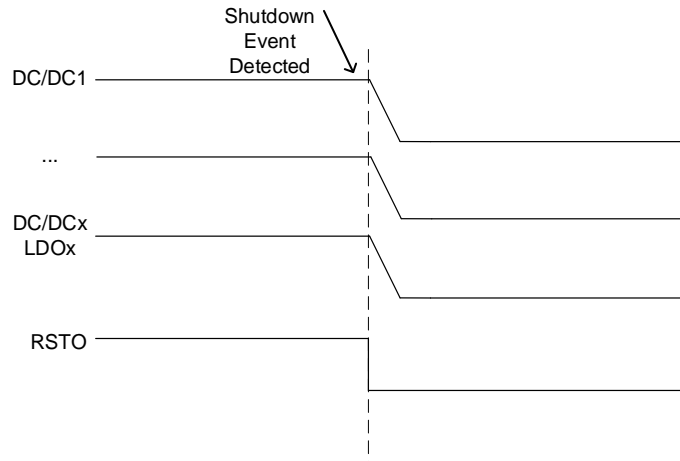

Figure 9: Shutdown Sequence

HIGH-EFFICIENCY BUCK REGULATORS

Buck 1 to buck 4 are synchronous, step-down DC/DC converters with built-in under-voltage lockout (UVLO), soft start, compensation, and hiccup current limit protection. Fixed-frequency constant-on-time (COT) control provides fast transient response. The switching clock is phase-shifted from buck 1 to buck 4 during continuous conduction mode (CCM). Buck 2 and buck 4 support 100% duty cycle mode.

Power Supply and Under-Voltage Lockout (UVLO)

VIN1 is the power supply for buck 1. VIN2 is the power supply for buck 2, LDORTC, LDO2, and LDO3. VIN3 is the power supply for buck 3. VIN4 is the supply for buck 4. VIN5 is the power supply for LDO4 and LDO5. AVIN is the power input for the biased internal logic blocks.

VIN1, VIN3, VIN5, and AVIN have their own under-voltage lockout (UVLO) thresholds with a proper hysteresis. VIN2 and VIN4 share the same UVLO threshold. If AVIN ramps up and exceeds the UVLO rising threshold, the nPBIN logic is enabled and ready to accept start-up and shutdown commands. LDORTC is active once VIN2 exceeds the rising threshold. Before the power key turns on, the input shutdown current is typically 15 μ A.

Internal Soft Start (SS)

Soft start (SS) is implemented to prevent the PMIC output voltage from overshooting during start-up. When the PMIC starts up, the internal circuitry of each power rail generates a soft-start voltage that ramps up from 0V. The soft-start

period lasts until the voltage on the soft-start capacitor exceeds the reference voltage. At this point, the reference voltage takes over. For the four buck outputs, their soft-start times are fixed internally at 450 μ s. For the LDO2-5 outputs, their soft-start times are fixed internally at 70 μ s. For LDORTC, the soft-start slew rate is always 35mV/ μ s.

Output Discharge

To discharge the energy of the output capacitor during a power-off sequence, there is an active discharge path from the DC/DC converters' and LDO regulators' output to ground. The discharge path turns on when the corresponding channel is disabled. The typical discharge resistance is 7 Ω . The discharge function can be enabled or disabled through the I²C interface.

SYSTEM CONTROL SIGNALS

nPBIN Functions

nPBIN is a multi-function pin that supports push-button detection and manual reset functions. There is an internal pull-up current to pull up nPBIN's voltage to AVIN. The MP5496 distinguishes between the push-button and manual reset functions by the different pull-low resistances. Connect nPBIN to ground for a manual reset function. Connect nPBIN to ground through a 34k Ω resistor to generate a push-button signal (see Figure 10).

A push-button event and manual reset event can both generate an interrupt signal, and set the corresponding interrupt bit high. See the Status 2 register on page 34 for details.

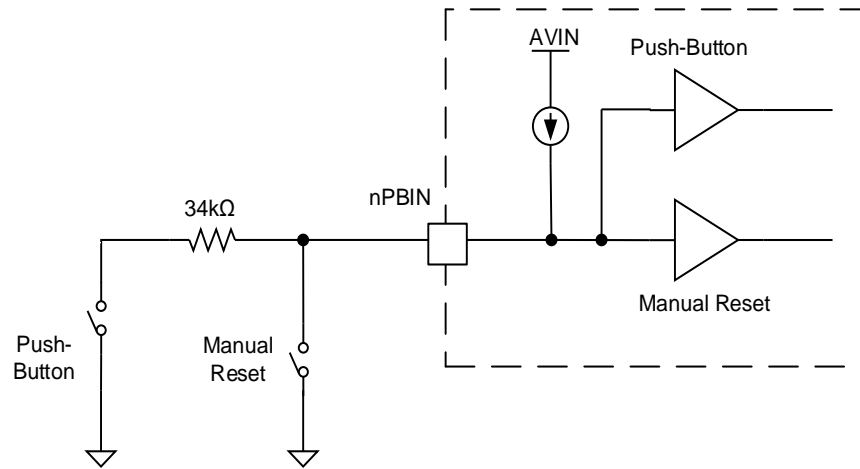

Figure 10: nPBIN Functional Block Diagram

Push-Button Control

Long Press 1/Start-Up: If AVIN exceeds the UVLO threshold and the push button asserts low for longer than 2 seconds when the PMIC is in the power-off state, the power-on sequence

begins. The power-on sequence must be completed before the backside CPU can take over control. The power-on sequence must be complete when the RSTO signal switches high (see Figure 11).

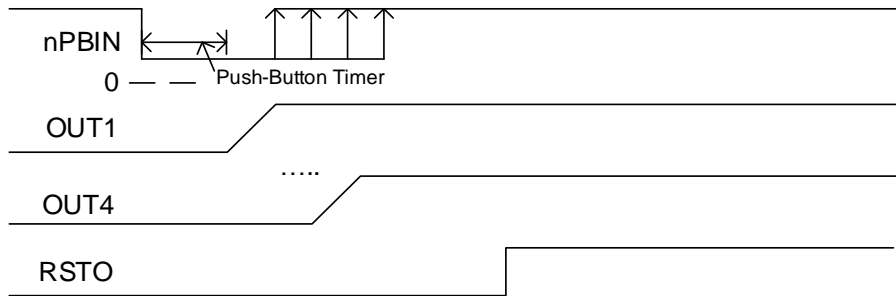

Figure 11: nPBIN Push-Button Long Press 1 (Start-Up)

Long Press 2/Shutdown: If the push button asserts low for more than 8 seconds during the power-on state, the power-off sequence begins. The MP5496 turns off all regulators and LDOs (excluding OUTRTC).

The power-off sequence turns off all components in the reverse order of start-up. If nPBIN is pulled low through a 34kΩ resistor at all times, the MP5496 remains in the power-off state (see Figure 12).

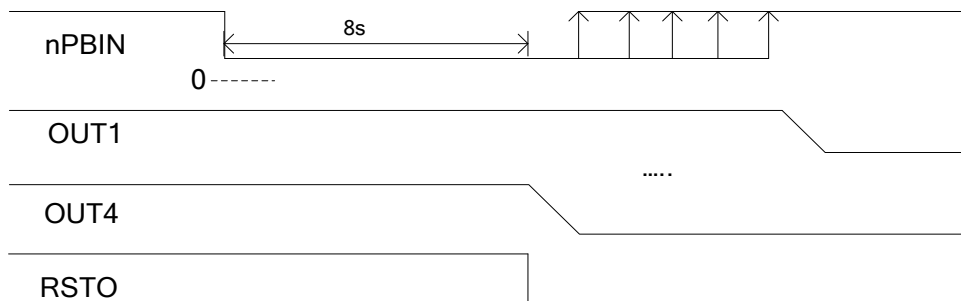

Figure 12: nPBIN Push Button Long Press 2 (Shutdown)

Manual Reset Control

Short Press and Release/Manual Reset: If the PMIC is in a power-off state, a short press on nPBIN pulls the nPBIN voltage below the manual reset threshold with a maximum 30ms debounce

time, and then the PMIC begins the power-on sequence. When the PMIC is powered on, a short press drops the nPBIN voltage below the manual reset threshold with a maximum 30ms debounce time, and triggers the manual reset function (see Figure 13).

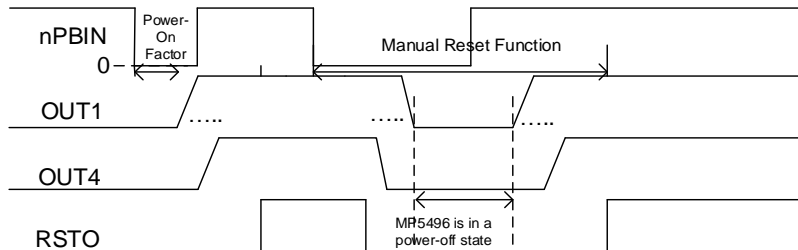

Figure 13: nPBIN Push Button Short Press to Ground

If the manual reset function is triggered, the PMIC turns off and remains off until the manual reset button is released. The PMIC enters the power-on state again after a maximum 30ms debounce time.

Automatic Turn-On

If the AUTOON bit in the OTP configuration table is set high, the system changes the default value of SYSEN to 1. The PMIC enters the power-on sequence automatically once the input voltage (AVIN) exceeds its under-voltage lockout (UVLO) threshold. The system can start up automatically without the push button being pressed. After start-up, the push button can still support the manual power-on and power-off control. SYSEN can be read or written by the I²C.

RSTO (Reset Output)

When buck 4's output voltage is ready (V_{FB} exceeds 90% of V_{REF}), RSTO outputs high to enable the processor after an RSTO delay time. RSTO is an open-drain structure with an external pull-up resistor. RSTO is pulled low when buck

4's output is below 80% of the nominal value, or when the system detects a power-off factor, shutdown factor, or repower-on factor.

Thermal Warning and Shutdown

Thermal warning and shutdown prevent the part from operating at exceedingly high temperatures. If the silicon die temperature exceeds 120°C, the MP5496 sets the OTWARNING bit to 1.

If the die temperature exceeds 153°C, the MP5496 sets the OTEMP bit to 1. Meanwhile, the system enters the shutdown sequence. When the temperature recovers to 130°C, the regulator enters the power-on sequence again.

I²C Timing Graph

The I²C interface of the PMIC is powered by an internal, fixed, 2V power supply. When VIN exceeds its UVLO threshold during VIN start-up, this 2V power supply is ready after a 0.5ms delay. After another 5ms of delay time, the I²C is available (see Figure 14).

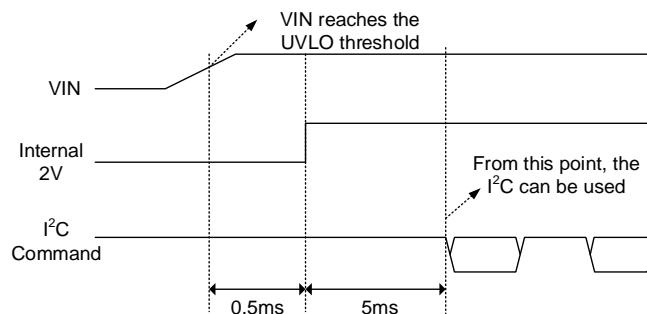

Figure 14: I²C Timing Graph

I²C INTERFACE

I²C Serial Interface Description

The I²C is a two-wire, bidirectional, serial interface consisting of a data line (SDA) and a clock line (SCL). The lines are externally pulled to a bus voltage when they are idle. A master device connected to the line generates the SCL signal and device address, and arranges the communication sequence.

The MP5496 interface is an I²C slave that supports both fast mode (400kHz) and high-speed mode (3.4MHz). The I²C interface adds flexibility to the power supply solution. The output voltage, transition slew rate, and other parameters can be controlled by the I²C interface instantaneously. When the master sends the address as an 8-bit value, the 7-bit address should be followed by a 0 or 1 to indicate a write or read operation, respectively.

Start and Stop Conditions

Start (S) and stop (P) conditions are signaled by the master device, which signifies the beginning and end of the I²C transfer. The start condition is defined as the SDA signal transitioning from high to low while the SCL is high. The stop condition is defined as the SDA signal transitioning from low to high while the SCL is high (see Figure 15).

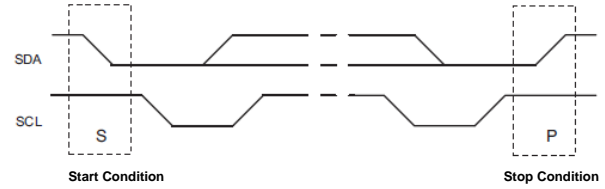

Figure 15: Start and Stop Conditions

The master generates the SCL clocks, then transmits the device address and the read/write direction bit (R/W) on the SDA line.

Transfer Data

Data is transferred in 8-bit bytes by the SDA line. Each byte of data must be followed by an acknowledge (ACK) bit.

I²C Update Sequence

The MP5496 requires a start condition, valid I²C address, register address byte, and a data byte for a single data update. The MP5496 acknowledges each byte that has been received by pulling the SDA line low during the high period of a single clock pulse. A valid I²C address selects the MP5496. The MP5496 performs an update on the falling edge of the LSB byte. Figure 16, Figure 17, and Figure 18 show examples of I²C write and read sequences.

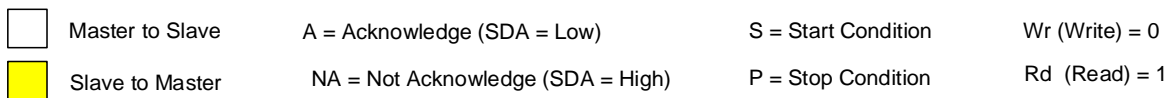

Figure 16: I²C Write Example (Write Single Register)

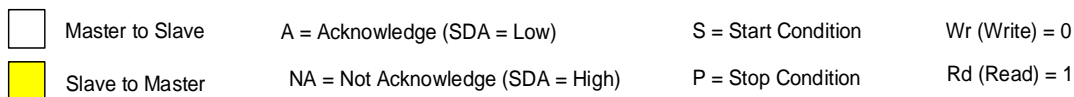
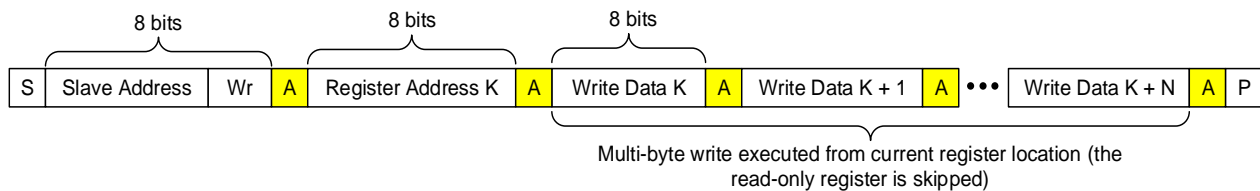

Figure 17: I²C Write Example (Write Multi-Register)

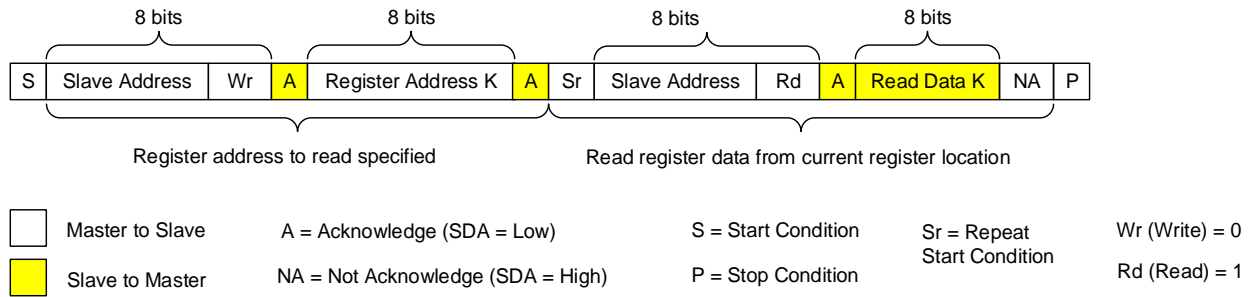

Figure 18: I²C Read Example (Read Single Register)

OTP REGISTER DESCRIPTION

OTP E-Fuse Configuration Table

#	NAME	D7	D6	D5	D4	D3	D2	D1	D0	
00	CTL1	AUTOON	FREQUENCY		PUSHBUTTONTIMER			RSTODELAY		
01	CTL2	ILIMBUCK1		ILIMBUCK3		N/A	PWRONDELAYBUCK1			
02	CTL3	MODEBUCK1	N/A	PWRONDELAYBUCK2			PWRONDELAYBUCK3			
03	CTL4	MODEBUCK2	N/A	PWRONDELAYBUCK4			PWRONDELAYLDO2			
04	CTL5	MODEBUCK3	N/A	PWRONDELAYLDO3			PWRONDELAYLDO4			
05	CTL6	MODEBUCK4	N/A	PWRONDELAYLDO5			N/A			
06	VSET1	ENBUCK1	Buck 1 V _{OUT} Set: 0.6V to 2.1V/100mV step				I ² C SLAVE ADDRESS A3, A2, A1			
07	VSET2	ENBUCK2	Buck 2 V _{OUT} Set: 0.6V to 2.1/50mV step					N/A		
08	VSET3	ENBUCK3	Buck 3 V _{OUT} Set: 0.6V to 2.1V/100mV step				N/A			
09	VSET4	ENBUCK4	Buck 4 V _{OUT} Set: 0.6V to 2.1V/50mV step					N/A		
10	VSET5	RESERVED	LDORTC V _{OUT} Set: 0.8V to 3.9V/100mV step					N/A		
11	VSET6	ENLDO2	LDO2 V _{OUT} Set: 0.8V to 3.9V/100mV step					N/A		
12	VSET7	ENLDO3	LDO3 V _{OUT} Set: 0.8V to 3.9V/100mV step					N/A		
13	VSET8	ENLDO4	LDO4 V _{OUT} Set: 0.8V to 3.9V/100mV step					OTP version D1, D0		
14	VSET9	ENLDO5	LDO5 V _{OUT} Set: 0.8V to 3.9V/100mV step					OTP version D3, D2		

OTP E-Fuse Selected Table by Default (MP5496GR-0001)

OTP Items	Buck 1	Buck 2	Buck 3	Buck 4	LDORTC	LDO2	LDO3	LDO4	LDO5
Output voltage	1.0V	0.9V	0.9V	1.8V	1.2V	3V	1.8V	1.2V	0.9V
Initial on/off	On	On	On	On	On	On	Off	On	On
Mode	FPWM	FPWM	FPWM	FPWM	N/A				
Power-on delay/time slot #	0ms/0	4ms/2	2ms/1	6ms/3	Always on	12ms/6	N/A	8ms/4	10ms/5
Automatic turn-on	Yes								
Switching frequency	1.5MHz								
Push-button timer	2 seconds								
RSTO delay	100ms								
Buck 1 peak current limit	6.8A								
Buck 3 peak current limit	5.6A								
I ² C slave address	0x69								
OTP version	0004								

Other Parameter Information for the MP5496GR-0001

	Buck 1	Buck 2	Buck 3	Buck 4	LDORTC	LDO2	LDO3	LDO4	LDO5
Minimum input voltage	3V								
Typical input voltage	3.3V								
Maximum input voltage	3.6V								

OTP REGISTERS

Bits	Name	Default	Description																																													
D[7]	AUTOON	1	System automatic turn-on bit. If AUTOON is set high, the system enters the power-on sequence when AVIN exceeds the UVLO rising threshold. Then the push button (nPBIN) does not have to be pressed. The AUTOON bit information is loaded into the SYSEN register after AVIN reaches the UVLO rising threshold.																																													
D[6:5]	FREQUENCY	01	Switching frequency selection bit. 00: f _{sw} = 1MHz 01: f _{sw} = 1.5MHz 10: f _{sw} = 2MHz 11: f _{sw} = 2.5MHz																																													
D[4:2]	PUSHBUTTON TIMER	011	This bit sets the push-button long press 1 power-on deglitch timer. <table border="1"> <thead> <tr> <th></th> <th>f_{sw} = 1MHz</th> <th>f_{sw} = 1.5MHz</th> <th>f_{sw} = 2MHz</th> <th>f_{sw} = 2.5MHz</th> </tr> </thead> <tbody> <tr> <td>000</td> <td>0.75s</td> <td>0.5s</td> <td>0.375s</td> <td>0.3s</td> </tr> <tr> <td>001</td> <td>1.5s</td> <td>1s</td> <td>0.75s</td> <td>0.6s</td> </tr> <tr> <td>010</td> <td>2.25s</td> <td>1.5s</td> <td>1.225s</td> <td>0.9s</td> </tr> <tr> <td>011</td> <td>3s</td> <td>2s</td> <td>1.5s</td> <td>1.2s</td> </tr> <tr> <td>100</td> <td>3.75s</td> <td>2.5s</td> <td>1.875s</td> <td>1.5s</td> </tr> <tr> <td>101</td> <td>4.5s</td> <td>3s</td> <td>2.25s</td> <td>1.8s</td> </tr> <tr> <td>110</td> <td>5.25s</td> <td>3.5s</td> <td>2.625s</td> <td>2.1s</td> </tr> <tr> <td>111</td> <td>6s</td> <td>4s</td> <td>3s</td> <td>2.4s</td> </tr> </tbody> </table> <p>There is no corresponding data in the I²C register table for these 3 bits.</p>		f _{sw} = 1MHz	f _{sw} = 1.5MHz	f _{sw} = 2MHz	f _{sw} = 2.5MHz	000	0.75s	0.5s	0.375s	0.3s	001	1.5s	1s	0.75s	0.6s	010	2.25s	1.5s	1.225s	0.9s	011	3s	2s	1.5s	1.2s	100	3.75s	2.5s	1.875s	1.5s	101	4.5s	3s	2.25s	1.8s	110	5.25s	3.5s	2.625s	2.1s	111	6s	4s	3s	2.4s
	f _{sw} = 1MHz	f _{sw} = 1.5MHz	f _{sw} = 2MHz	f _{sw} = 2.5MHz																																												
000	0.75s	0.5s	0.375s	0.3s																																												
001	1.5s	1s	0.75s	0.6s																																												
010	2.25s	1.5s	1.225s	0.9s																																												
011	3s	2s	1.5s	1.2s																																												
100	3.75s	2.5s	1.875s	1.5s																																												
101	4.5s	3s	2.25s	1.8s																																												
110	5.25s	3.5s	2.625s	2.1s																																												
111	6s	4s	3s	2.4s																																												
D[1:0]	RSTODELAY	01	This bit sets the reset output delay. <table border="1"> <thead> <tr> <th></th> <th>f_{sw} = 1MHz</th> <th>f_{sw} = 1.5MHz</th> <th>f_{sw} = 2MHz</th> <th>f_{sw} = 2.5MHz</th> </tr> </thead> <tbody> <tr> <td>00</td> <td>210ms</td> <td>140ms</td> <td>105ms</td> <td>84ms</td> </tr> <tr> <td>01</td> <td>150ms</td> <td>100ms</td> <td>75ms</td> <td>60ms</td> </tr> <tr> <td>10</td> <td>75ms</td> <td>50ms</td> <td>37.5ms</td> <td>30ms</td> </tr> <tr> <td>11</td> <td>15ms</td> <td>10ms</td> <td>7.5ms</td> <td>6ms</td> </tr> </tbody> </table> <p>There is no corresponding data in the I²C register table for these 3 bits.</p>		f _{sw} = 1MHz	f _{sw} = 1.5MHz	f _{sw} = 2MHz	f _{sw} = 2.5MHz	00	210ms	140ms	105ms	84ms	01	150ms	100ms	75ms	60ms	10	75ms	50ms	37.5ms	30ms	11	15ms	10ms	7.5ms	6ms																				
	f _{sw} = 1MHz	f _{sw} = 1.5MHz	f _{sw} = 2MHz	f _{sw} = 2.5MHz																																												
00	210ms	140ms	105ms	84ms																																												
01	150ms	100ms	75ms	60ms																																												
10	75ms	50ms	37.5ms	30ms																																												
11	15ms	10ms	7.5ms	6ms																																												
3 bits	PWRONDELAY BUCK1 PWRONDELAY BUCK2 PWRONDELAY BUCK3 PWRONDELAY BUCK4 PWRONDELAY LDO2 PWRONDELAY LDO2 PWRONDELAY LDO3 PWRONDELAY LDO4 PWRONDELAY LDO5 PWRONDELAY LDO6	N/A	Delay time from when SYSEN goes high to when the bucks/LDOs begin to switch. 000: 0ms (time slot 0) 001: 2ms (time slot 1) 010: 4ms (time slot 2) 011: 6ms (time slot 3) 100: 8ms (time slot 4) 101: 10ms (time slot 5) 110: 12ms (time slot 6) 111: 14ms (time slot 7) The delay time between neighboring slots are related to the PMIC default switching frequency. See the operation section on page 18 for details. There is no corresponding data in the I ² C register table for these 3 bits.																																													

Bits	Name	Default	Description
1 bit	MODE BUCK1 MODE BUCK2 MODE BUCK3 MODE BUCK4	N/A	Selects the mode (auto-PFM/PWM mode or forced PWM mode). 0: Auto-PFM/PWM mode 1: Forced PWM mode (default for buck 1, buck 2, buck 3, and buck 4) These bits are loaded into the I ² C MODEBUCKx registers when VIN1 exceeds its UVLO threshold.
2 bits	ILIMBUCK1 ILIMBUCK3	11 (Buck 1) 10 (Buck 3)	Programs the current limit threshold of the buck regulator: 00: 3.8A typical high-side peak current limit 01: 4.6A typical high-side peak current limit 10: 5.6A typical high-side peak current limit 11: 6.8A typical high-side peak current limit
3 bits	I2C SLAVE ADDRESS A3, A2, A1	001	Sets the A1, A2, and A3 bits of the slave's I ² C address. See the I ² C Bus Slave Address section on page 30 for more details.

I²C REGISTER MAP

Add (Hex)	Name	R/W	D7	D6	D5	D4	D3	D2	D1	D0
00	CTL0	R/W	SYSEN	SFRST	RESERVED				RESERVED	RESERVED
01	CTL1	R/W	RESERVED	MODE BUCK1	MODE BUCK2	MODE BUCK3	MODE BUCK4	DISCHG BUCK3	DISCHG BUCK2	DISCHG BUCK1
02	CTL2	R/W	DVS SLEW RATE		DISCHG BUCK4	DISCHG LDO2	DISCHG LDO3	DISCHG LDO4	DISCHG LDO5	RESERVED
03	ILIMIT	R/W	ILIMBUCK1		ILIMBUCK3		ILIMBUCK2		ILIMBUCK4	
04	VSET1	R/W	ENBUCK1	Buck 1 output voltage set: 0.6V to 2.1875V/12.5mV step						
05	VSET2	R/W	ENBUCK2	Buck 2 output voltage set: 0.6V to 2.1875V/12.5mV step						
06	VSET3	R/W	ENBUCK3	Buck 3 output voltage set: 0.6V to 2.1875V/12.5mV step						
07	VSET4	R/W	ENBUCK4	Buck 4 output voltage set: 0.6V to 2.1875V/12.5mV step						
08	VSET5	R/W	ENLDO2	LDO2 output voltage set: 0.8V to 3.975V/25mV step						
09	VSET6	R/W	ENLDO3	LDO3 output voltage set: 0.8V to 3.975V/25mV step						
0A	VSET7	R/W	ENLDO4	LDO4 output voltage set: 0.8V to 3.975V/25mV step						
0B	VSET8	R/W	ENLDO5	LDO5 output voltage set: 0.8V to 3.975V/25mV step						
0C	RESERVED									
0D	Status1	R	PGLDO4	PGLDO3	PGLDO2	PGRTC	PG4	PG3	PG2	PG1
0E	Status2	R	KEYON	KEYOFF	MREST	SHORTKEY ON	SFRST_ON	RESERVED	RESERVED	PGLDO5
0F	Status3	R	OT WARNING	OTEMPP	RESERVED	RESERVED	RESERVED	RESERVED	RESERVED	RESERVED
10	RESERVED									
11	ID2	R	VENDOR ID				OTP VERSION			

REGISTER DESCRIPTION

I²C Bus Slave Address ⁽¹¹⁾

The slave address is 7 bits followed by an 8th data direction bit (read or write). The A3, A2, and A1 bits can be configured via the OTP e-fuse.

	A7	A6	A5	A4	A3	A2	A1
Setting Value	1	1	0	1	0 ⁽¹²⁾	0 ⁽¹²⁾	1 ⁽¹²⁾

Notes:

- 11) By default, the slave address is 0x69, A[7:1] = 1101 001.
 12) This bit is configurable via the OTP e-fuse.

I²C REGISTERS

Reg 00: CTL0

Bits	Name	Default	Description	Reset Condition
D[7]	SYSEN	BY OTP AUTO ON	System enable on/off bit. If the MP5496 detects a power-on event, this bit is set to 1. Then the power-on sequence starts. The DC/DC converters and LDO regulators turn on sequentially according to their enable bits (e.g. ENBUCK1 = 1) and power-on delay (POWERONDELAYBUCK1) settings. Set this bit from 1 to 0 to trigger a power-off sequence. Other I ² C registers are not reset when the I ² C sets SYSEN from 1 to 0. The MP5496 is enabled again until the push button is long-pressed or a manual reset is asserted for more than 30ms of the maximum debounce time.	AVIN < UVLO
D[6]	SFRST	0	Software reset. Once the SFRST bit is set high, the MP5496 waits for 8ms, then restarts all of the power rails. When the RSTO signal switches from low to high, the MP5496 resets SFRST and sets it to 0.	<ul style="list-style-type: none"> • AVIN < UVLO • RSTO from low to high

Reg 01: CTL1

Bits	Name	Default	Description	Reset Condition
D[6:3]	MODE BUCK1 MODE BUCK2 MODE BUCK3 MODE BUCK4	BY OTP	PFM/PWM mode or forced PWM mode. 0: Auto-PFM/PWM 1: Forced PWM mode	<ul style="list-style-type: none"> • AVIN < UVLO • SFRST • Manual reset • Long press 2
D[2:0]	Regulator Discharge	1	Output discharge enable bit. The output discharge function is active during the power-off sequence.	

Reg 02: CTL2

Bits	Name	Default	Description	Reset Condition
D[7:6]	DVS SLEW RATE	01	Voltage scaling slew rate for the buck 1 to buck 4 converters. 00: 32mV/μs 01: 16mV/μs 10: 8mV/μs 11: 4mV/μs	<ul style="list-style-type: none"> • AVIN < UVLO • SFRST • Manual reset • Long press 2
D[5:0]	Regulator Discharge	1	Output discharge enable bit. The output discharge function is active during the power-off sequence and remains active after shutdown.	

Reg 03: ILIMIT

Bits	Name	Default	Description	Reset Condition
D[7:6] D[5:4]	ILIMBUCK1 ILIMBUCK3	BY OTP	Sets the current-limit threshold of the buck regulator. 00: 3.8A typical high-side peak current limit 01: 4.6A typical high-side peak current limit 10: 5.6A typical high-side peak current limit 11: 6.8A typical high-side peak current limit	<ul style="list-style-type: none"> • AVIN < UVLO • SFRST • Manual reset • Long press 2
D[3:2] D[1:0]	ILIMBUCK2 ILIMBUCK4	10	Sets the current-limit threshold of the buck regulator. 00: 2.2A typical high-side peak current limit 01: 3.2A typical high-side peak current limit 10: 4.2A typical high-side peak current limit 11: 5.2A typical high-side peak current limit	

Reg 04 to Reg 0B: VOUTSET and EN

Bits	Name	Default	Description	Reset Condition
D[7]	ENBUCK1 ENBUCK2 ENBUCK3 ENBUCK4 ENLDO2 ENLDO3 ENLDO4 ENLDO5	BY OTP	Enable bit for buck regulators and LDOs. The default value is 1, but the default SYSEN is set to 0. Regulators are enabled when both ENx = 1 and SYSEN = 1.	<ul style="list-style-type: none"> • AVIN < UVLO • SFRST • Manual reset • Long press 2
D[6:0]	BUCK1 VOUTSET BUCK2 VOUTSET BUCK3 VOUTSET BUCK4 VOUTSET	BY OTP	Sets the output voltage from 0.6V to 2.1875V with 12.5mV steps (see Table 2).	

Table 2: Output Voltage Chart for Buck 1, Buck 2, Buck 3, and Buck 4

D[6:0]	V _{OUT} (V)	D[6:0]	V _{OUT} (V)	D[6:0]	V _{OUT} (V)	D[6:0]	V _{OUT} (V)
000000	0.6000	010000	1.0000	100000	1.4000	110000	1.8000
000001	0.6125	010001	1.0125	100001	1.4125	110001	1.8125
000010	0.6250	010010	1.0250	100010	1.4250	110010	1.8250
000011	0.6375	010011	1.0375	100011	1.4375	110011	1.8375
000100	0.6500	0100100	1.0500	1000100	1.4500	1100100	1.8500
000101	0.6625	0100101	1.0625	1000101	1.4625	1100101	1.8625
000110	0.6750	0100110	1.0750	1000110	1.4750	1100110	1.8750
000111	0.6875	0100111	1.0875	1000111	1.4875	1100111	1.8875
0001000	0.7000	0101000	1.1000	1001000	1.5000	1101000	1.9000
0001001	0.7125	0101001	1.1125	1001001	1.5125	1101001	1.9125
0001010	0.7250	0101010	1.1250	1001010	1.5250	1101010	1.9250
0001011	0.7375	0101011	1.1375	1001011	1.5375	1101011	1.9375
0001100	0.7500	0101100	1.1500	1001100	1.5500	1101100	1.9500
0001101	0.7625	0101101	1.1625	1001101	1.5625	1101101	1.9625
0001110	0.7750	0101110	1.1750	1001110	1.5750	1101110	1.9750
0001111	0.7875	0101111	1.1875	1001111	1.5875	1101111	1.9875
0010000	0.8000	0110000	1.2000	1010000	1.6000	1110000	2.0000
0010001	0.8125	0110001	1.2125	1010001	1.6125	1110001	2.0125
0010010	0.8250	0110010	1.2250	1010010	1.6250	1110010	2.0250
0010011	0.8375	0110011	1.2375	1010011	1.6375	1110011	2.0375

0010100	0.8500	0110100	1.2500	1010100	1.6500	1110100	2.0500
0010101	0.8625	0110101	1.2625	1010101	1.6625	1110101	2.0625
0010110	0.8750	0110110	1.2750	1010110	1.6750	1110110	2.0750
0010111	0.8875	0110111	1.2875	1010111	1.6875	1110111	2.0875
0011000	0.9000	0111000	1.3000	1011000	1.7000	1111000	2.1000
0011001	0.9125	0111001	1.3125	1011001	1.7125	1111001	2.1125
0011010	0.9250	0111010	1.3250	1011010	1.7250	1111010	2.1250

Table 2: Output Voltage Chart for Buck 1, Buck 2, Buck 3, and Buck 4 (continued)

D[6:0]	V _{OUT} (V)	D[6:0]	V _{OUT} (V)	D[6:0]	V _{OUT} (V)	D[6:0]	V _{OUT} (V)
0011011	0.9375	0111011	1.3375	1011011	1.7375	1111011	2.1375
0011100	0.9500	0111100	1.3500	1011100	1.7500	1111100	2.1500
0011101	0.9625	0111101	1.3625	1011101	1.7625	1111101	2.1625
0011110	0.9750	0111110	1.3750	1011110	1.7750	1111110	2.1750
0011111	0.9875	0111111	1.3875	1011111	1.7875	1111111	2.1875

LDO Regulator Output Voltage Set

Bits	Name	Default	Description	Reset Condition
D[6:0]	LDOVOUT SET	BY OTP	Sets the output voltage from 0.8V to 3.975V with 25mV steps (see Table 3).	<ul style="list-style-type: none"> • AVIN < UVLO • SFRST • Manual reset • Long press 2

Table 3: Output Voltage Chart of all LDOs

D[6:0]	V _{OUT} (V)	D[6:0]	V _{OUT} (V)	D[6:0]	V _{OUT} (V)	D[6:0]	V _{OUT} (V)
0000000	0.800	0100000	1.600	1000000	2.400	1100000	3.200
0000001	0.825	0100001	1.625	1000001	2.425	1100001	3.225
0000010	0.850	0100010	1.650	1000010	2.450	1100010	3.250
0000011	0.875	0100011	1.675	1000011	2.475	1100011	3.275
0000100	0.900	0100100	1.700	1000100	2.500	1100100	3.300
0000101	0.925	0100101	1.725	1000101	2.525	1100101	3.325
0000110	0.950	0100110	1.750	1000110	2.550	1100110	3.350
0000111	0.975	0100111	1.775	1000111	2.575	1100111	3.375
0001000	1.000	0101000	1.800	1001000	2.600	1101000	3.400
0001001	1.025	0101001	1.825	1001001	2.625	1101001	3.425
0001010	1.050	0101010	1.850	1001010	2.650	1101010	3.450
0001011	1.075	0101011	1.875	1001011	2.675	1101011	3.475
0001100	1.100	0101100	1.900	1001100	2.700	1101100	3.500
0001101	1.125	0101101	1.925	1001101	2.725	1101101	3.525
0001110	1.150	0101110	1.950	1001110	2.750	1101110	3.550
0001111	1.175	0101111	1.975	1001111	2.775	1101111	3.575
0010000	1.200	0110000	2.000	1010000	2.800	1110000	3.600
0010001	1.225	0110001	2.025	1010001	2.825	1110001	3.625
0010010	1.250	0110010	2.050	1010010	2.850	1110010	3.650
0010011	1.275	0110011	2.075	1010011	2.875	1110011	3.675
0010100	1.300	0110100	2.100	1010100	2.900	1110100	3.700
0010101	1.325	0110101	2.125	1010101	2.925	1110101	3.725
0010110	1.350	0110110	2.150	1010110	2.950	1110110	3.750
0010111	1.375	0110111	2.175	1010111	2.975	1110111	3.775
0011000	1.400	0111000	2.200	1011000	3.000	1111000	3.800
0011001	1.425	0111001	2.225	1011001	3.025	1111001	3.825
0011010	1.450	0111010	2.250	1011010	3.050	1111010	3.850
0011011	1.475	0111011	2.275	1011011	3.075	1111011	3.875
0011100	1.500	0111100	2.300	1011100	3.100	1111100	3.900
0011101	1.525	0111101	2.325	1011101	3.125	1111101	3.925
0011110	1.550	0111110	2.350	1011110	3.150	1111110	3.950
0011111	1.575	0111111	2.375	1011111	3.175	1111111	3.975

Reg 0D: Status 1

Status registers are non-latch. This register automatically updates according to its real-time status.

Bits	Name	Description	Reset Condition
D[7:0]	PG1 PG2 PG3 PG4 PGLDO2 PGLDO3 PGLDO4 PGLDORTC	<p>Power good indicator for the bucks and LDOs. PG = 1 when the output voltage exceeds 90% of the reference voltage. PG = 0 when the output voltage is below 80% of the reference voltage.</p> <p>During the I²C-controlled dynamic voltage scaling, the PG deglitch timer blanks the possible PG glitch.</p>	<ul style="list-style-type: none"> • AVIN < UVLO • SFRST • Manual reset • Long press 2

Reg 0E: Status 2

Bits	Name	Description	Reset Condition
D[7]	KEYON	A push-button power-on event (long press 1) is detected.	AVIN < UVLO
D[6]	KEYOFF	A push-button power-off event (long press 2) is detected.	
D[5]	MREST	A manual reset event is detected.	
D[4]	SHORTKEYON	If the MP5496 is in a power-off state, nPBIN is pulled to ground and lasts longer than the maximum 30ms debounce time. Then the SHORTKEYON bit is set high.	
D[3]	SFRST_ON	A software reset event is detected. When the SFRST bit is set high, the SFRST_ON bit goes high, and the high state is latched.	
D[0]	PGLDO5	Power good indicator for LDO5. Non-latch bits.	<ul style="list-style-type: none"> • AVIN < UVLO • SFRST • Manual reset • Long press 2

Reg 0F: Status 3

Bits	Name	Description	Reset Condition
D[7]	OTWARNING	Die temperature early warning bit. If the bit is high, the die temperature has exceeded 120°C.	AVIN < UVLO
D[6]	OTEMPP	Over-temperature indication. If the bit is high, the IC is in thermal shutdown.	

Reg 11: ID2

Bits	Name	Description
D[7:4]	Vendor ID	1000.
D[3:0]	OTP version	0100.

APPLICATION INFORMATION

Selecting the Inductor

For most applications, use a 0.47µH to 2.2µH inductor with a DC current rating at least 25% greater than the maximum load current. For the highest efficiency, use an inductor with a DC resistance below 15mΩ. For most designs, the inductance value can be calculated with Equation (1):

$$L_1 = \frac{V_{OUT} \times (V_{IN} - V_{OUT})}{V_{IN} \times \Delta I_L \times f_{OSC}} \quad (1)$$

Where ΔI_L is the inductor ripple current.

Choose the inductor ripple current to be approximately 30% of the maximum load current. The maximum inductor peak current can be estimated with Equation (2):

$$I_{L(MAX)} = I_{LOAD} + \frac{\Delta I_L}{2} \quad (2)$$

Use a larger inductor (<100mA) to improve efficiency under light-load conditions.

Selecting the Step-Down Converter Input Capacitor

The step-down converter has discontinuous input current, and requires a capacitor to supply AC current to the converter while maintaining the DC input voltage. Use low ESR capacitors for the best performance. Ceramic capacitors with X5R or X7R dielectrics are recommended because of their low ESR and small temperature coefficients. For most applications, use a 22µF capacitor.

Since C1 absorbs the input switching current, it requires an adequate ripple current rating. The RMS current in the input capacitor can be estimated with Equation (3):

$$I_{C1} = I_{LOAD} \times \sqrt{\frac{V_{OUT}}{V_{IN}} \times \left(1 - \frac{V_{OUT}}{V_{IN}}\right)} \quad (3)$$

The worst-case condition occurs at $V_{IN} = 2V_{OUT}$, calculated with Equation (4):

$$I_{C1} = \frac{I_{LOAD}}{2} \quad (4)$$

For simplification, choose an input capacitor with an RMS current rating greater than half of the maximum load current.

The input capacitor can be electrolytic, tantalum, or ceramic. When using electrolytic or tantalum capacitors, add a small, high-quality, ceramic capacitor (e.g. 0.1µF) placed as close to the IC as possible. When using ceramic capacitors, ensure that they have enough capacitance to provide sufficient charge to prevent excessive voltage ripple at the input. The input voltage ripple caused by the capacitance can be estimated with Equation (5):

$$\Delta V_{IN} = \frac{I_{LOAD}}{f_{SW} \times C1} \times \frac{V_{OUT}}{V_{IN}} \times \left(1 - \frac{V_{OUT}}{V_{IN}}\right) \quad (5)$$

Selecting the Step-Down Converter Output Capacitor

The output capacitor for the step-down regulator maintains the DC output voltage. Use ceramic, tantalum, or low-ESR electrolytic capacitors. For the best results, use low-ESR capacitors to keep the output voltage ripple low. The output voltage ripple can be estimated with Equation (6):

$$\Delta V_{OUT} = \frac{V_{OUT}}{f_{SW} \times L_1} \times \left(1 - \frac{V_{OUT}}{V_{IN}}\right) \times \left(R_{ESR} + \frac{1}{8 \times f_{SW} \times C2}\right) \quad (6)$$

Where L_1 is the inductor value, and R_{ESR} is the equivalent series resistance (ESR) value of the output capacitor.

For ceramic capacitors, the capacitance dominates the impedance at the switching frequency and causes the majority of the output voltage ripple. For simplification, the output voltage ripple can be estimated with Equation (7):

$$\Delta V_{OUT} = \frac{V_{OUT}}{8 \times f_{SW}^2 \times L_1 \times C2} \times \left(1 - \frac{V_{OUT}}{V_{IN}}\right) \quad (7)$$

For tantalum or electrolytic capacitors, the ESR dominates the impedance at the switching frequency. For simplification, the output ripple can be calculated with Equation (8):

$$\Delta V_{OUT} = \frac{V_{OUT}}{f_{SW} \times L_1} \times \left(1 - \frac{V_{OUT}}{V_{IN}}\right) \times R_{ESR} \quad (8)$$

The characteristics of the output capacitor also affect the stability of the regulation.

Recommended External Components for DC/DC and LDO Converters

Table 4 lists recommended external components for the DC/DC converters and LDO regulators.

Table 4: Recommended External Components

Component	Value	Description
VIN1 C _{IN}	22μF	0805 size/10V ceramic capacitor
VIN2 C _{IN}	22μF	0805 size/10V ceramic capacitor
VIN3 C _{IN}	22μF	0805 size/10V ceramic capacitor
VIN4 C _{IN}	22μF	0805 size/10V ceramic capacitor
VIN5 C _{IN}	10μF	0805 size/10V ceramic capacitor
AVIN C _{IN}	1μF	0603 size/10V ceramic capacitor
Buck 1 C _{OUT}	22μF x 2	0805 size/10V ceramic capacitor
Buck 1 inductance	1μH	I _{SAT} > current limit
Buck 2 C _{OUT}	22μF	0805 size/10V ceramic capacitor
Buck 2 inductance	1μH	I _{SAT} > current limit
Buck 3 C _{OUT}	22μF x 2	0805 size/10V ceramic capacitor
Buck 3 inductance	1μH	I _{SAT} > current limit
Buck 4 C _{OUT}	22μF	0805 size/10V ceramic capacitor
Buck 4 inductance	1.5μH	I _{SAT} > current limit
RTCLDO C _{OUT}	1μF	0603 size/6.3V ceramic capacitor
LDO2 C _{OUT}	2.2μF	0603 size/6.3V ceramic capacitor
LDO3 C _{OUT}	2.2μF	0603 size/6.3V ceramic capacitor
LDO4 C _{OUT}	2.2μF	0603 size/6.3V ceramic capacitor
LDO5 C _{OUT}	2.2μF	0603 size/6.3V ceramic capacitor
RSTO pull-up resistor	100kΩ	0603 or 0402 size film resistor
nPBIN pull-low resistor	34kΩ	Push-button function, 0603 or 0402 size film resistor
AVIN series resistor to VIN1	10Ω	0603 or 0402 size film resistor

PCB Layout Guidelines ⁽¹³⁾

Efficient PCB layout is critical for stable operation. A 4-layer layout is recommended for the best performance. For the best results, refer to Figure 14 and follow the guidelines below:

1. Connect the input ground to GND using the shortest and widest trace possible.
2. Connect the input capacitor to VIN using the shortest and widest trace possible.

3. Ensure that FB1, FB2, FB3, and FB4 are Kelvin-connected to the buck output capacitors. Do not directly connect FB to the inductor's output node.
4. Route SW away from sensitive analog areas, such as FB1 to FB4.

Note:

13) The recommended layout is based on Figure 20 on page 38.

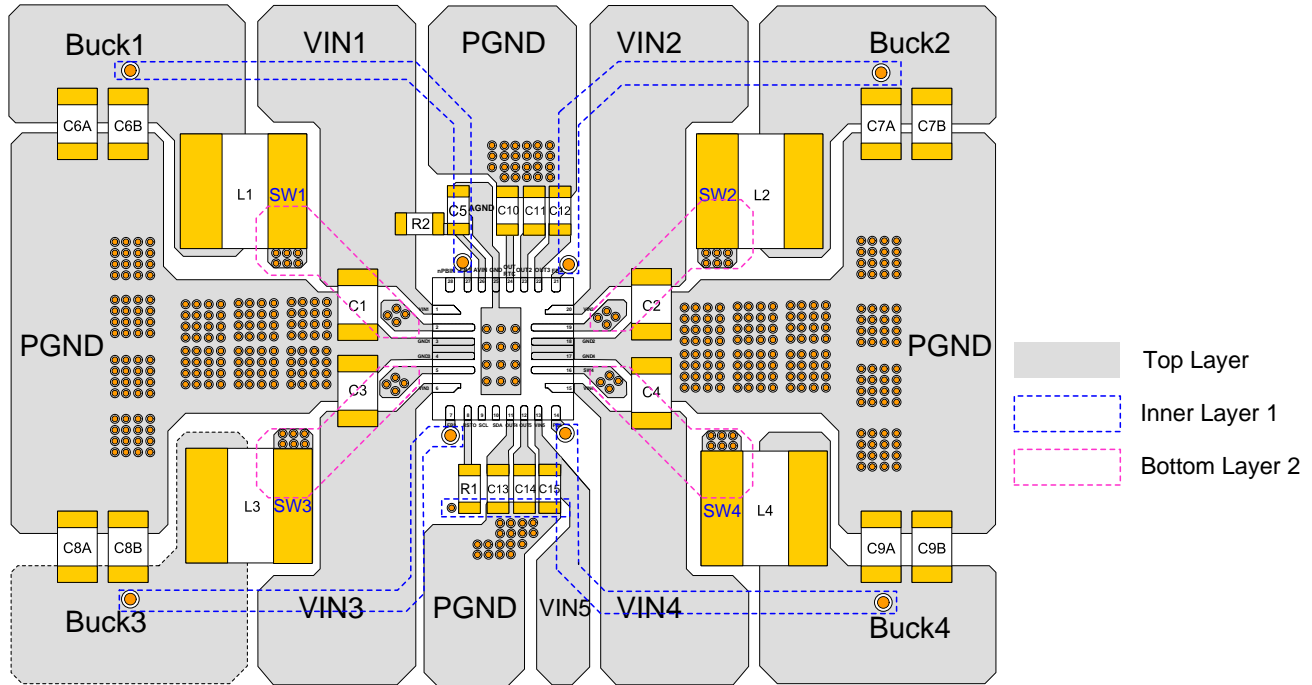

Figure 19: Recommended Layout ⁽¹⁴⁾

Note:

14) It is recommended to separate Buck 1/3 and Buck 2/4's PGND on the top layer.

TYPICAL APPLICATION CIRCUIT

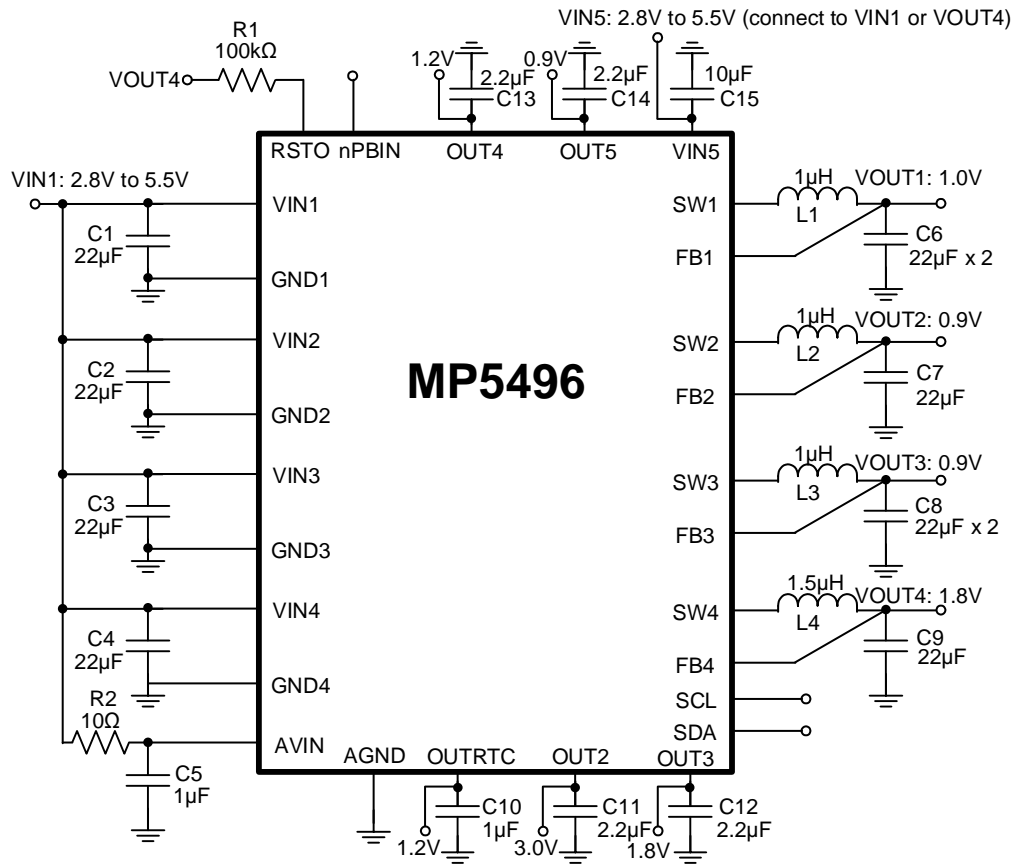
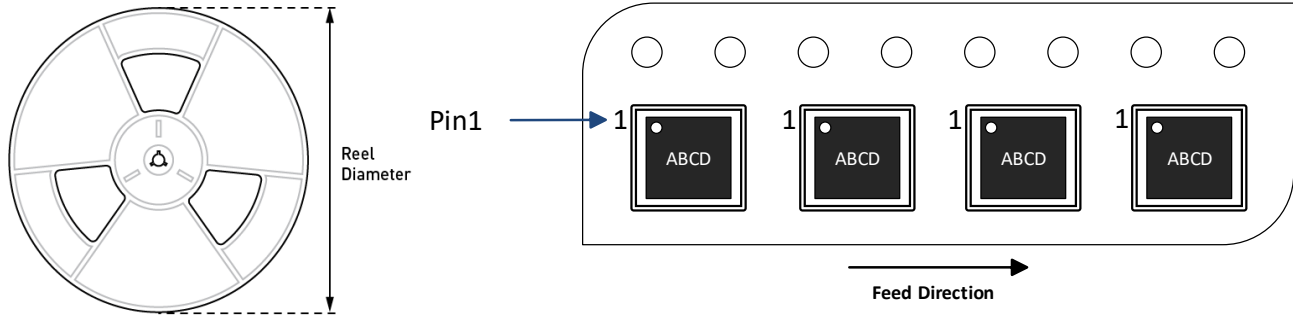

Figure 20: Typical Application Circuit ⁽¹⁵⁾

Note:

15) The minimum input voltage of VIN5 is equal to the maximum nominal output voltage of LDO4 and LDO5.

CARRIER INFORMATION

Part Number	Package Description	Quantity/ Reel	Quantity/ Tray	Quantity/ Tube	Reel Diameter	Carrier Tape Width	Carrier Tape Pitch
MP5496GR-0001-Z	QFN-28 (4mmx4mm)	5000	N/A	N/A	13in	12mm	8mm

Revision History

Revision #	Revision Date	Description	Pages Updated
1.0	8/25/2020	Initial Release	-

Notice: The information in this document is subject to change without notice. Users should warrant and guarantee that third-party Intellectual Property rights are not infringed upon when integrating MPS products into any application. MPS will not assume any legal responsibility for any said applications.