

### DESCRIPTION

The MP1907A is a high frequency, 100V half bridge N-channel power MOSFET driver. Its low side and high side driver channels are independently controlled and matched with less than 5ns in time delay. Under-voltage lock-out both high side and low side supplies force their outputs low in case of insufficient supply. Both outputs will remain low until a rising edge on either input is detected. The integrated bootstrap diode reduces external component count.

### FEATURES

- Drives N-channel MOSFET half bridge
- 100V  $V_{BST}$  voltage range
- On-chip bootstrap diode
- Typical 20ns propagation delay time
- Less than 5ns drive mismatch
- Drive 1nF load with 12ns/9ns rise/fall times with 12V VDD
- TTL compatible input
- Less than 150µA quiescent current
- Less than 1µA shutdown current
- UVLO for both high side and low side
- In QFN-10 (3mmx3mm) Packages

### APPLICATIONS

- Battery Powered Hand Tool
- Telecom half bridge power supplies
- Avionics DC-DC converters
- Active-clamp Forward Converters

All MPS parts are lead-free and adhere to the RoHS directive. For MPS green status, please visit MPS website under Products, Quality Assurance page.

"MPS" and "The Future of Analog IC Technology" are registered trademarks of Monolithic Power Systems, Inc.

### TYPICAL APPLICATION

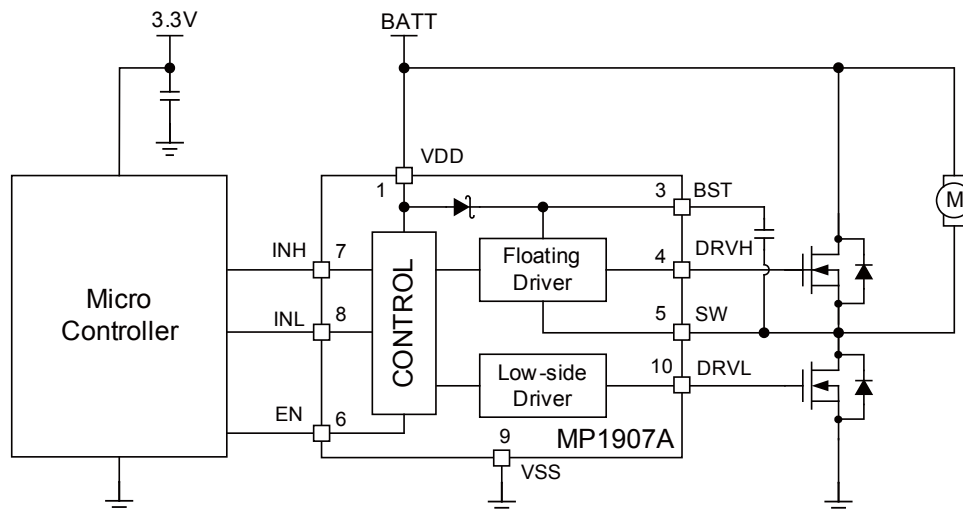

### ORDERING INFORMATION

Part Number*	Package	Top Marking
MP1907AGQ	QFN-10 (3mmx3mm)	See Below

\* For Tape & Reel, add suffix -Z (e.g. MP1907AGQ-Z);

### TOP MARKING

**AKZY**

**LLL**

AKZ: product code of MP1907AGQ;  
 Y: year code;  
 LLL: lot number;

### PACKAGE REFERENCE

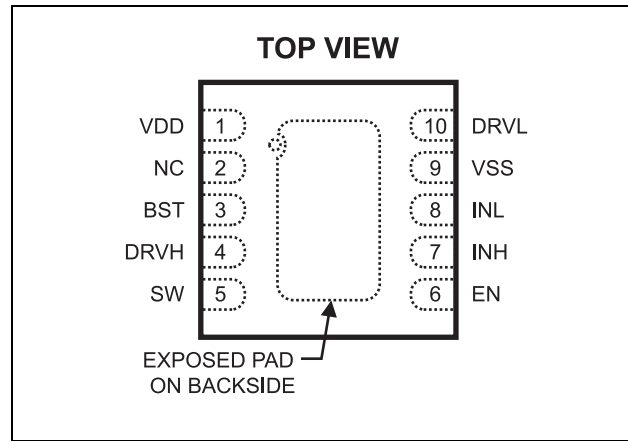

**ABSOLUTE MAXIMUM RATINGS <sup>(1)</sup>**

Supply Voltage ( $V_{DD}$ ).....	-0.3V to +20V
SW Voltage ( $V_{SW}$ ) .....	-5.0V to 105V
BST Voltage ( $V_{BST}$ ) .....	-0.3V to 110V
BST to SW .....	-0.3V to +18V
DRVH to SW .....	-0.3V to (BST-SW) +0.3V
DRVL to VSS .....	-0.3V to ( $V_{DD}$ +0.3V)
All Other Pins .....	-0.3V to 20V
Continuous Power Dissipation ( $T_A = +25^\circ\text{C}$ ) <sup>(2)</sup>	
QFN-10 (3mmx3mm).....	2.5W
Junction Temperature .....	150°C
Lead Temperature .....	260°C
Storage Temperature.....	-65°C to +150°C

**Recommended Operating Conditions <sup>(3)</sup>**

Supply Voltage ( $V_{DD}$ ).....	+4.5V to 18V <sup>(4)</sup>
SW Voltage ( $V_{SW}$ ) .....	-1.0V to 100V
SW slew rate.....	<50V/nsec
Operating Temp. ( $T_J=T_A$ ). .....	-40°C to +125°C

<b>Thermal Resistance <sup>(5)</sup></b>	<b><math>\theta_{JA}</math></b>	<b><math>\theta_{JC}</math></b>	
QFN-10 (3mmx3mm).....	50 .....	12...	°C/W

**Notes:**

- 1) Exceeding these ratings may damage the device.
- 2) The maximum allowable power dissipation is a function of the maximum junction temperature  $T_J$  (MAX), the junction-to-ambient thermal resistance  $\theta_{JA}$ , and the ambient temperature  $T_A$ . The maximum allowable continuous power dissipation at any ambient temperature is calculated by  $P_D$  (MAX) =  $(T_J$  (MAX)- $T_A$ )/ $\theta_{JA}$ . Exceeding the maximum allowable power dissipation will cause excessive die temperature, and the regulator will go into thermal shutdown. Internal thermal shutdown circuitry protects the device from permanent damage.
- 3) The device is not guaranteed to function outside of its operating conditions.
- 4) 4.5V is only a typical value for minimum supply voltage at  $V_{DD}$  falling
- 5) Measured on JESD51-7, 4-layer PCB.

## ELECTRICAL CHARACTERISTICS

$V_{DD} = V_{BST} - V_{SW} = 12V$ ,  $V_{SS} = V_{SW} = 0V$ ,  $V_{EN} = 3.3V$ , No load at DRVH and DRVL,  $T_J = -40^{\circ}C$  to  $125^{\circ}C$ , typical value is tested at  $T_J = +25^{\circ}C$ , unless otherwise noted.

Parameter	Symbol	Condition	Min	Typ	Max	Units
<b>Supply Current</b>						
VDD Shutdown Current	$I_{SHDN}$	$V_{EN}=0$ ,		0	1	$\mu A$
VDD quiescent current	$I_{DDQ}$	$INL=INH=0$		80	100	$\mu A$
VDD operating current	$I_{DDO}$	$f_{sw}=500kHz$		2.8	3.5	mA
Floating driver quiescent current	$I_{BSTQ}$	$INL=0, INH=0$ or 1		55	70	$\mu A$
Floating driver operating current	$I_{BSTO}$	$f_{sw}=500kHz$		2.1	3	mA
Leakage Current	$I_{LK}$	$BST=SW=100V$		0.05	1	$\mu A$
<b>Inputs</b>						
INL/INH High			2.4			V
INL/INH Low					1	V
INL/INH Hysteresis				0.6		V
INL/INH internal pull-down resistance	$R_{IN}$			200		$k\Omega$
<b>Over Temperature Protection</b>						
OTP rising threshold <sup>(6)</sup>	$T_{SDR}$			155		$^{\circ}C$
OTP falling threshold <sup>(6)</sup>	$T_{SDF}$			128		$^{\circ}C$
<b>Under Voltage Protection</b>						
VDD rising threshold	$V_{DDR}$		4.6	5.0	5.4	V
VDD falling threshold	$V_{DDF}$		4.1	4.5	4.9	V
(BST-SW) rising threshold	$V_{BSTR}$		3.3	4.1	4.9	V
(BST-SW) falling threshold	$V_{BSTF}$		3	3.8	4.6	V
EN Input Logic Low					0.7	V
EN Input Logic High			1.5			V
EN Hysteresis				100		mV
EN Input Current	$I_{EN}$	$V_{EN}=2V$		10		$\mu A$
EN internal pull-down resistance	$R_{EN}$			200		$k\Omega$
<b>Bootstrap Diode</b>						
Bootstrap diode VF @ 100uA	$V_{F1}$				0.8	V
Bootstrap diode VF @ 10mA	$V_{F2}$			0.7	1	V
Bootstrap diode dynamic R	$R_D$			2.7		$\Omega$
<b>Low Side Gate Driver</b>						
Low level output voltage	$V_{OLL}$	$I_O=100mA$		0.15	0.3	V
High level output voltage to rail	$V_{OHL}$	$I_O=-100mA$		0.45	0.6	V
Peak pull-up current <sup>(6)</sup>	$I_{OHL}$	$V_{DRVL}=0V, V_{DD}=4.5V^{(7)}$		0.15		A
		$V_{DRVL}=0V, V_{DD}=12V$		1.5		A
		$V_{DRVL}=0V, V_{DD}=16V$		2.5		A
Peak pull-down current <sup>(6)</sup>	$I_{OLL}$	$V_{DRVL}=V_{DD}=4.5V^{(7)}$		0.25		A
		$V_{DRVL}=V_{DD}=12V$		2.5		A
		$V_{DRVL}=V_{DD}=16V$		3.5		A

**ELECTRICAL CHARACTERISTICS (continued)**

$V_{DD} = V_{BST} - V_{SW} = 12V$ ,  $V_{SS} = V_{SW} = 0V$ ,  $V_{EN} = 3.3V$ , No load at DRVH and DRVL,  $T_A = +25^\circ C$ , unless otherwise noted.

Parameter	Symbol	Condition	Min	Typ	Max	Units
<b>Floating Gate Driver</b>						
Low level output voltage	$V_{OLH}$	$I_O = 100mA$		0.15	0.3	V
High level output voltage to rail	$V_{OHH}$	$I_O = -100mA$		0.45	0.6	V
Peak pull-up current <sup>(6)</sup>	$I_{OHH}$	$V_{DRVH} = 0V$ , $V_{BST} - V_{SW} = 5V$ <sup>(8)</sup>		0.25		A
		$V_{DRVH} = 0V$ , $V_{DD} = 12V$		1.5		A
		$V_{DRVH} = 0V$ , $V_{DD} = 16V$		2.5		A
Peak pull-down current <sup>(6)</sup>	$I_{OLH}$	$V_{DRVH} = V_{BST} - V_{SW} = 5V$ <sup>(8)</sup>		0.65		A
		$V_{DRVH} = V_{DD} = 12V$		2.5		A
		$V_{DRVH} = V_{DD} = 16V$		3.5		A
<b>Switching Spec. --- Low Side Gate Driver</b>						
Turn-off propagation delay INL falling to DRVL falling	$T_{DLFF}$			20		ns
Turn-on propagation delay INL rising to DRVL rising	$T_{DLRR}$			20		ns
DRVL rise time		$C_L = 1nF$		12		ns
DRVL fall time		$C_L = 1nF$		9		ns
<b>Switching Spec. --- Floating Gate Driver</b>						
Turn-off propagation delay INH falling to DRVH falling	$T_{DHFF}$			20		ns
Turn-on propagation delay INH rising to DRVH rising	$T_{DHRR}$			18		ns
DRVH rise time		$C_L = 1nF$		12		ns
DRVH fall time		$C_L = 1nF$		9		ns
<b>Switching Spec. --- Matching</b>						
Minimum input pulse width that changes the output <sup>(6)</sup>	$T_{PW}$				50	ns
Bootstrap diode turn-on or turn-off time <sup>(6)</sup>	$T_{BS}$			10		ns

Note:

- 6) Guaranteed by design.
- 7) After startup  $V_{DD}$  fall to 4.5V
- 8) After startup  $V_{BST} - V_{SW}$  fall to 5V

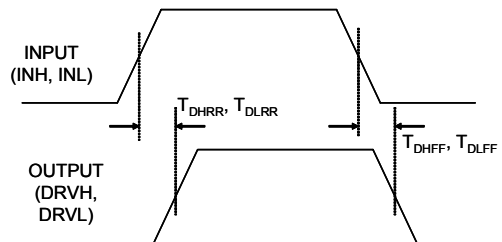

**Figure 1—Timing Diagram**

## PIN FUNCTIONS

Package Pin #	Name	Description
1	VDD	Supply input. This pin supplies power to all the internal circuitry. A decoupling capacitor to ground must be placed close to this pin to ensure stable and clean supply.
2	NC	No Connection.
3	BST	Bootstrap. This is the positive power supply for the internal floating high-side MOSFET driver. Connect a bypass capacitor between this pin and SW pin.
4	DRVH	Floating driver output.
5	SW	Switching node.
6	EN	On/off Control.
7	INH	Control signal input for the floating driver.
8	INL	Control signal input for the low side driver.
9	VSS, Exposed Pad	Chip ground. Connect to Exposed pad to VSS for proper thermal operation.
10	DRVL	Low side driver output.

## TYPICAL PERFORMANCE CHARACTERISTICS

$V_{DD} = 12V$ ,  $V_{SS} = V_{SW} = 0V$ ,  $T_A = +25^\circ C$ , unless otherwise noted.

**$I_{DDO}$  Operation Current vs. Frequency**

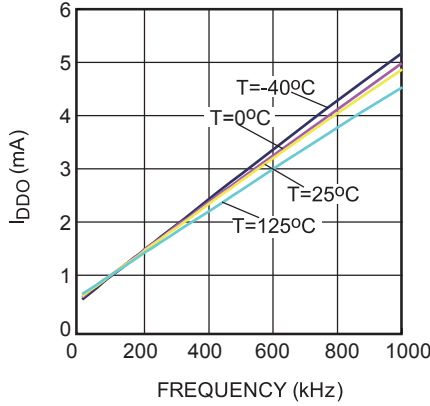

**$I_{BSTO}$  Operation Current vs. Frequency**

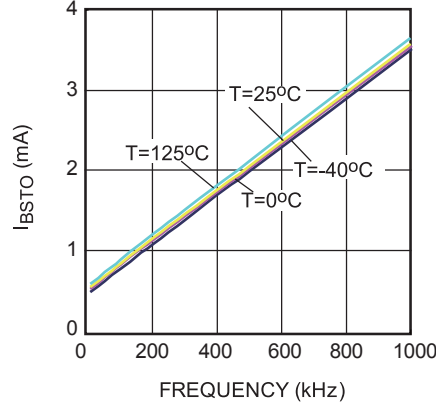

**High Level Output Voltage vs. Temperature**

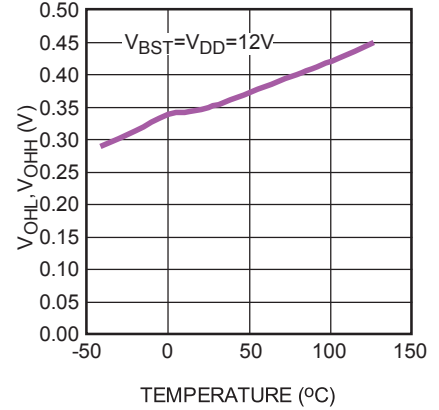

**Low Level Output Voltage vs. Temperature**

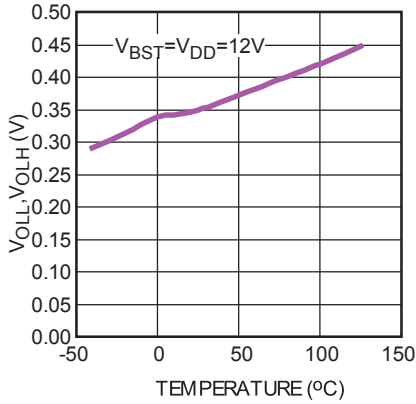

**Undervoltage Lockout Threshold vs. Temperature**

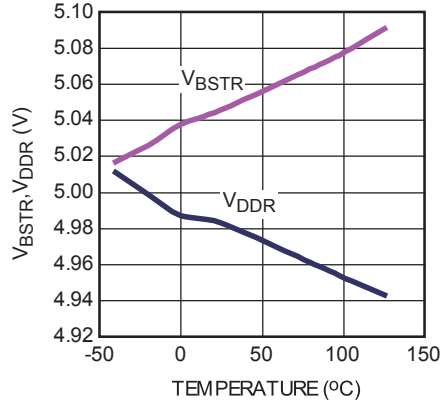

**Undervoltage Lockout Hysteresis vs. Temperature**

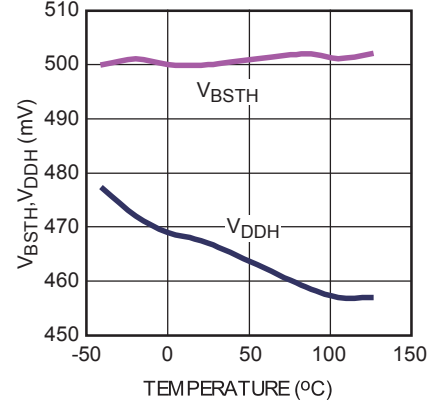

**Propagation Delay vs. Temperature**

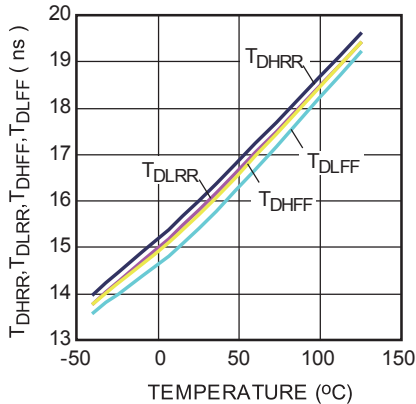

**Bootstrap Diode I-V Characteristics**

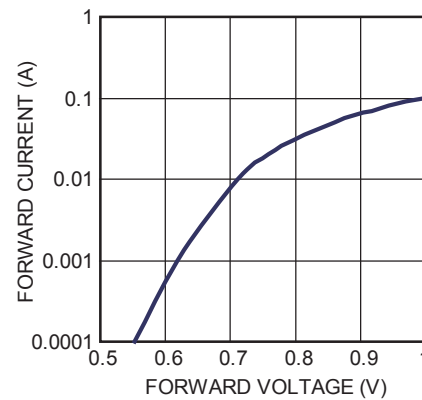

**Quiescent Current vs. Voltage**

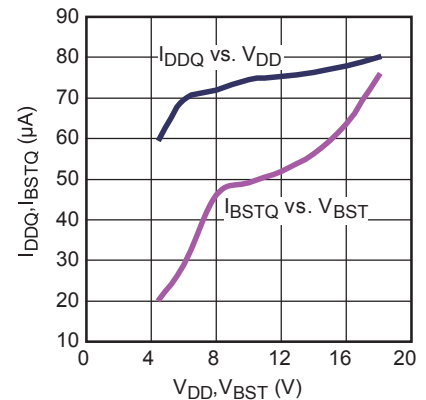

**TYPICAL PERFORMANCE CHARACTERISTICS** *(continued)*

$V_{DD} = 12V$ ,  $V_{SS} = V_{SW} = 0V$ ,  $T_A = +25^\circ C$ , unless otherwise noted.

**Peak Current vs.  $V_{DD}$  Voltage**

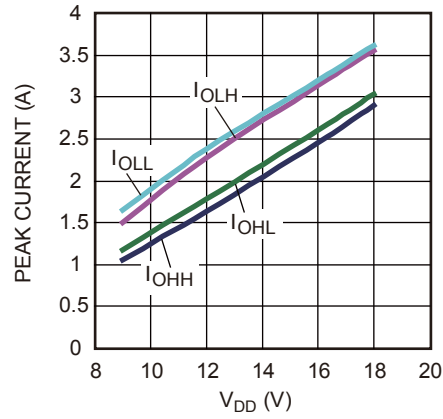

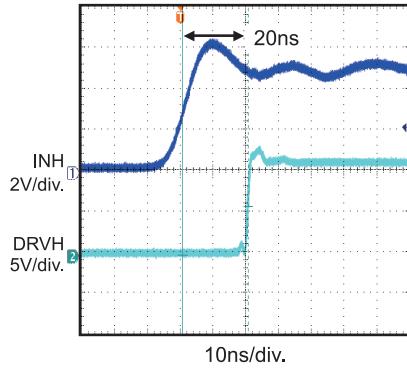
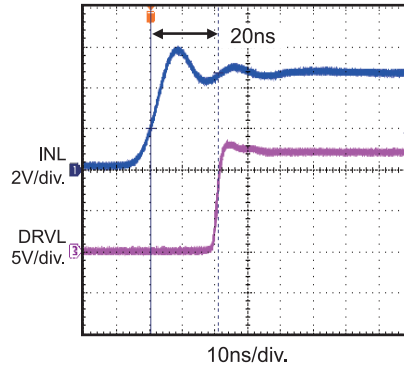
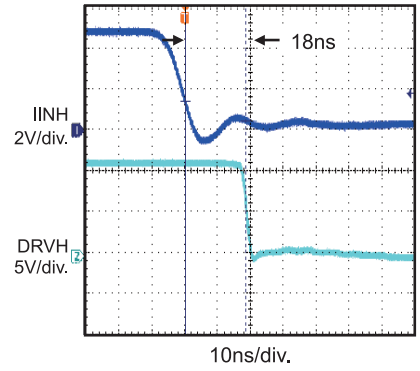
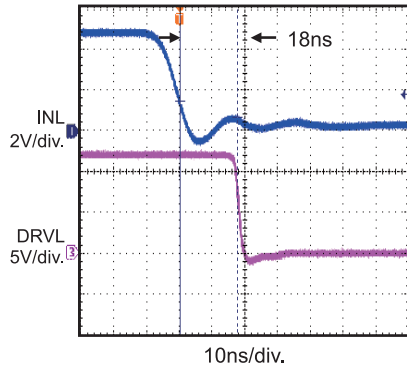
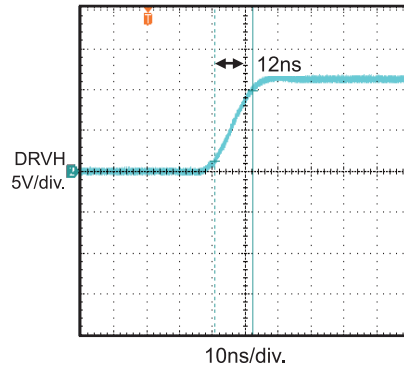
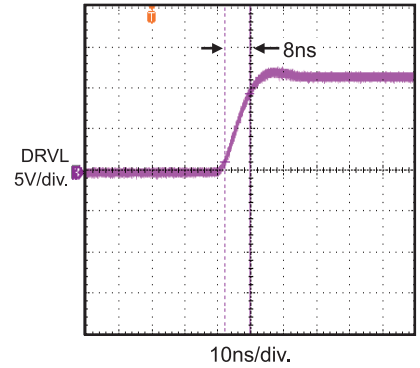
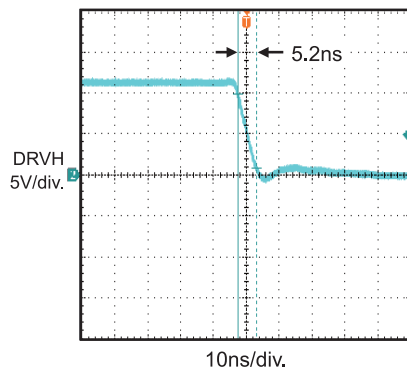
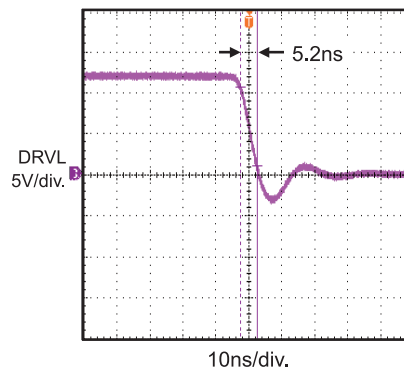

**TYPICAL PERFORMANCE CHARACTERISTICS (continued)**
 $V_{DD} = 12V, V_{SS} = V_{SW} = 0V, T_A = +25^\circ C$ , unless otherwise noted.

**Turn-on Propagation Delay**

**Turn-on Propagation Delay**

**Turn-off Protection Delay**

**Turn-off Protection Delay**

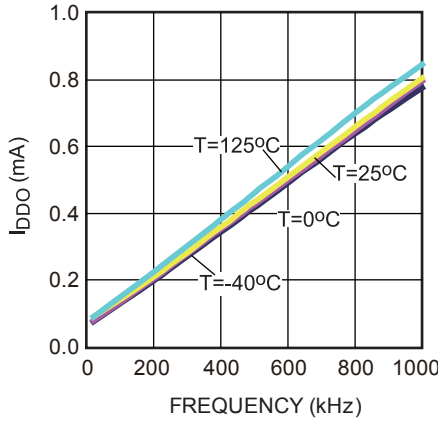
**Drive Rise Time (1nF Load)**

**Drive Rise Time (1nF Load)**

**Drive Fall Time (1nF Load)**

**Drive Fall Time (1nF Load)**

**TYPICAL PERFORMANCE CHARACTERISTICS** *(continued)*

$V_{DD} = 5V$ , after startup  $V_{DD}$  falls to 5V,  $V_{SS} = V_{SW} = 0V$ ,  $T_A = +25^\circ C$ , unless otherwise noted.

**$I_{DDO}$  Operation Current vs. Frequency**



**$I_{BSTO}$  Operation Current vs. Frequency**

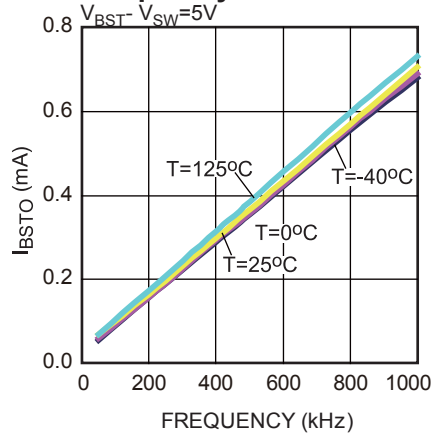

**High Level Output Voltage vs. Temperature**

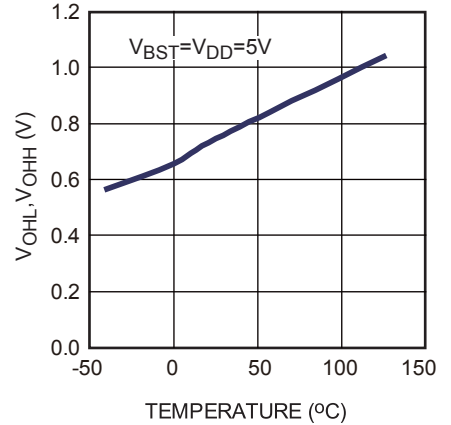

**Low Level Output Voltage vs. Temperature**

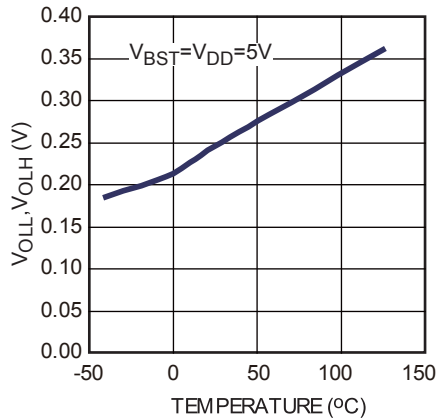

**Propagation Delay vs. Temperature**

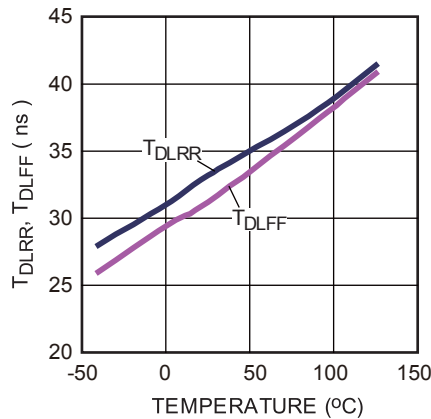

**TYPICAL PERFORMANCE CHARACTERISTICS (continued)**
 $V_{DD} = 5V$ , after startup  $V_{DD}$  falls to 5V,  $V_{SS} = V_{SW} = 0V$ ,  $T_A = +25^\circ C$ , unless otherwise noted.

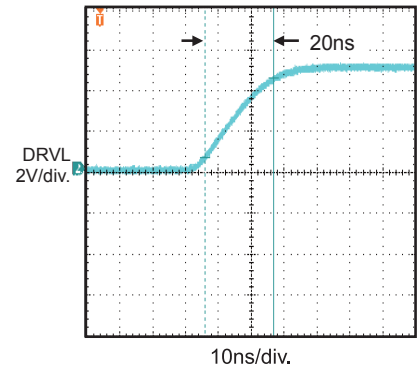
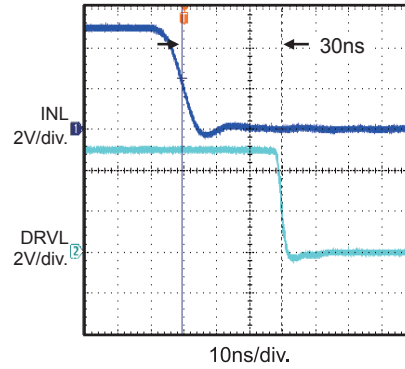
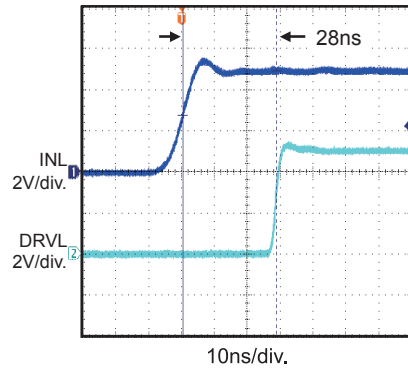
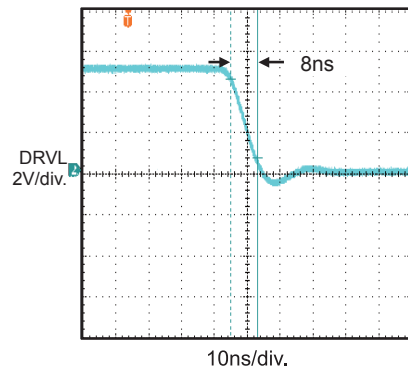
**Turn-on Propagation Delay**
**Turn-off Propagation Delay**
**Drive Rise Time (1nF Load)**

**Drive Fall Time (1nF Load)**

BLOCK DIAGRAM

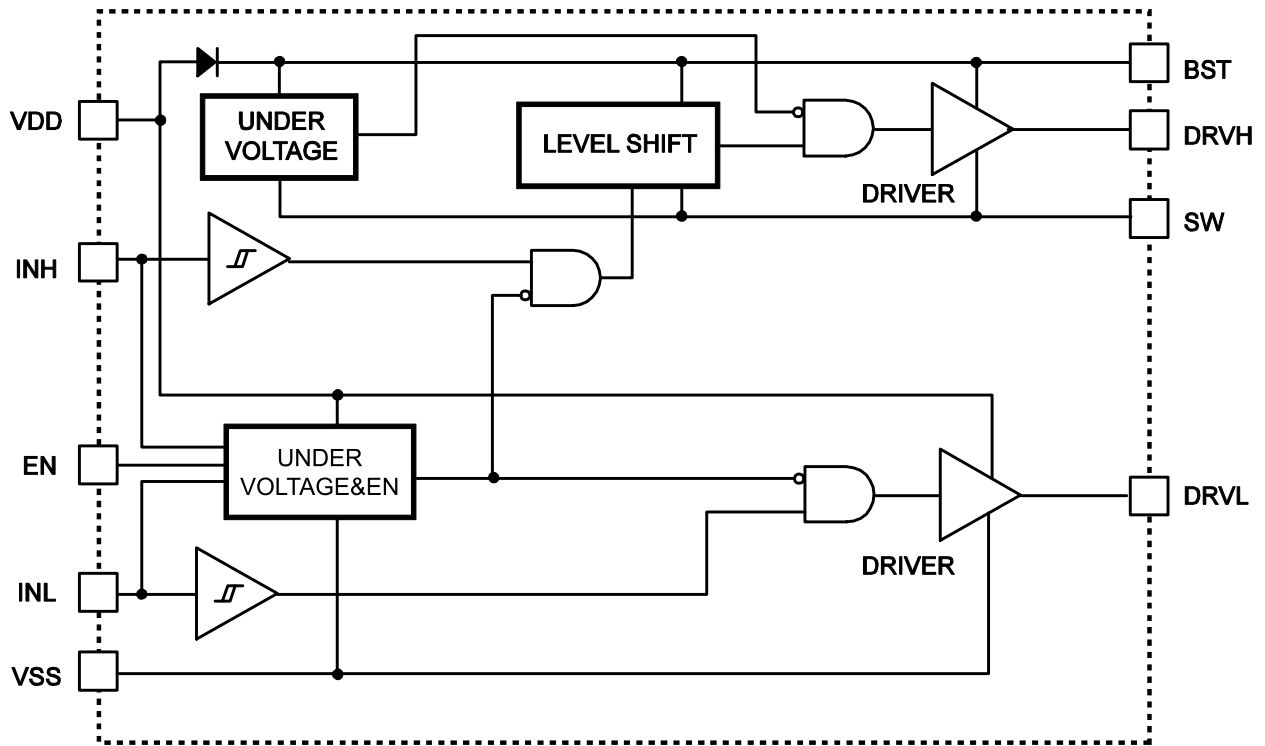

Figure 2—Function Block Diagram

## OPERATION

### Under Voltage Lock Out

When VDD or BST goes below their respective UVLO thresholds, both DRVH and DRVL outputs will go low to turn off both FETs. Once VDD rises above the UVLO threshold, both

DRVH and DRVL will stay low until a rising edge is detected on either INH or INL.

The truth table in Table 1 details the operation of the HSFET and LSFET under different INH, INL and UVLO conditions

**Table1 States of Driver Output under different conditions**

EN	BST-SW Voltage	V <sub>DD</sub> Voltage	INH	INL	DRVH	DRVL	UVLO Latch status	Operating Condition
0	X	X	X	X	Open	200kΩ pull down	X	X
1	X	X	0	0	0	0	X	Normal Operation
	X	X	1	1	0	0	X	
	X	Above UVLO	0	1	0	1	Normal	
	Above UVLO	Above UVLO	1	0	1	0	Normal	
	Above UVLO	Above UVLO	1	1	1	1	Normal	
	Falls below UVLO	Above UVLO	X	X	0	0	Normal to Tripped	Normal-to-Tripped Transition
	Above UVLO	Falls below UVLO	X	X	0	0	Normal to Tripped	
	X	Above UVLO	0 or 1	0 or 1	0	0	Tripped	When UVLO latch is tripped.
	X	Below UVLO	X	X	0	0	Tripped	
	X	Above UVLO	0 to 1	0 to 1	0	0	Tripped, Reset by INL & INH	Tripped to Normal Transition
	X	Above UVLO	1 to 0	1	0	0 to 1	Tripped, Reset by INH Falling	
	Below UVLO	Above UVLO	1	1 to 0	0	0	Tripped, Reset by INL Falling	
	Above UVLO	Above UVLO	1	1 to 0	1	1 to 0	Tripped, Reset by INL Falling	
Below UVLO	Above UVLO	0	0 to 1	0	0 to 1	Tripped, Reset by INL		
Below UVLO	Above UVLO	0 to 1	0	0	0	Tripped, Reset by INH		
Above UVLO	Above UVLO	0 to 1	0	0 to 1	0	Tripped, Reset by INH		

Note: x = Don't Care.

## APPLICATION INFORMATION

### Reference Design Circuits

#### Half Bridge Motor Driver

In half-bridge converter topology, the MOSFETs are driven alternately with some dead time. Therefore, INH and INL are driven with

alternating signals from the PWM controller. The input voltage can be up to 100V in this application.

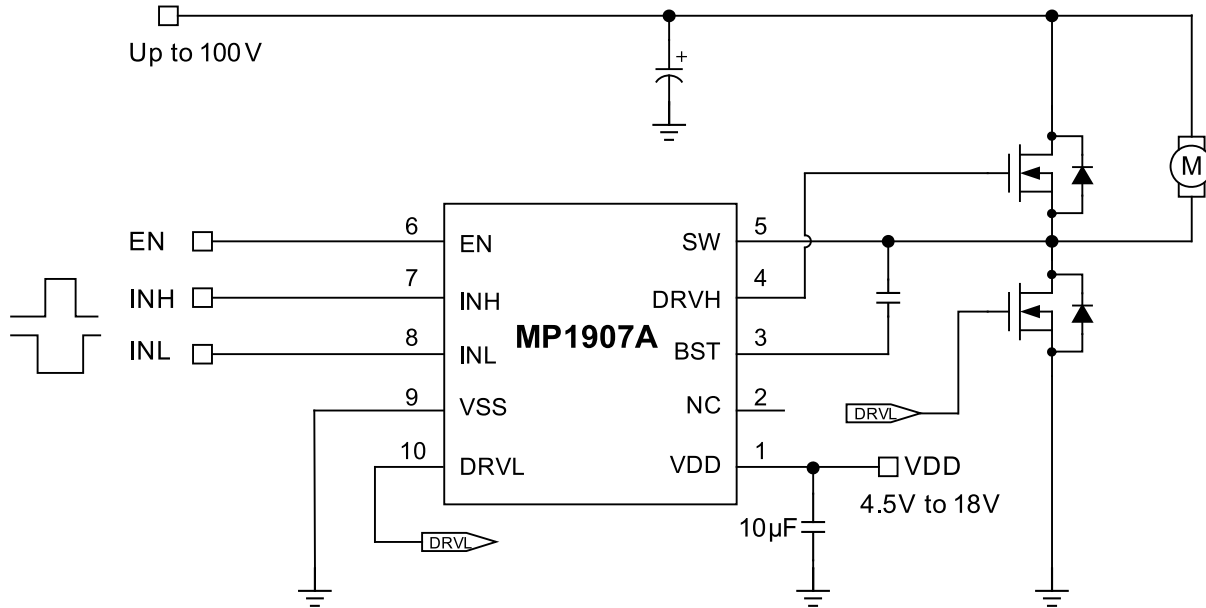
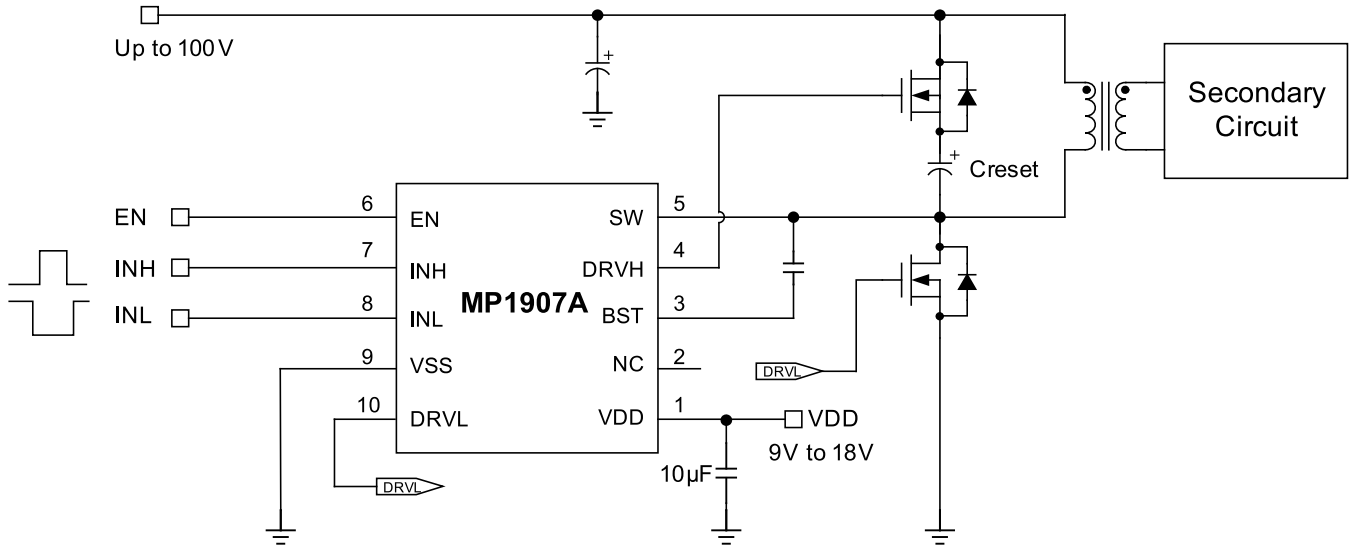

**Figure 3—Half-Bridge Motor Driver**

### Active-Clamp Forward Converter

In active-clamp forward converter topology, the MOSFETs are driven alternately. The high-side MOSFET, along with capacitor  $C_{reset}$ , is used to reset the power transformer in a lossless manner.

This topology lends itself well to run at duty cycles exceeding 50%. For these reasons, the input voltage may not be able to run at 100V for this application.



**Figure 4—Active-clamp Forward Converter**

## PACKAGE INFORMATION

### QFN-10 (3mmx3mm)

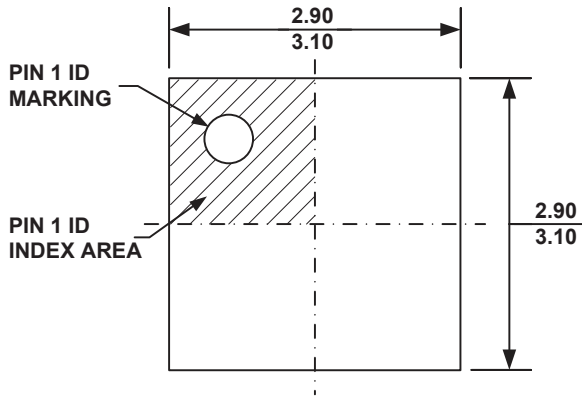

**TOP VIEW**

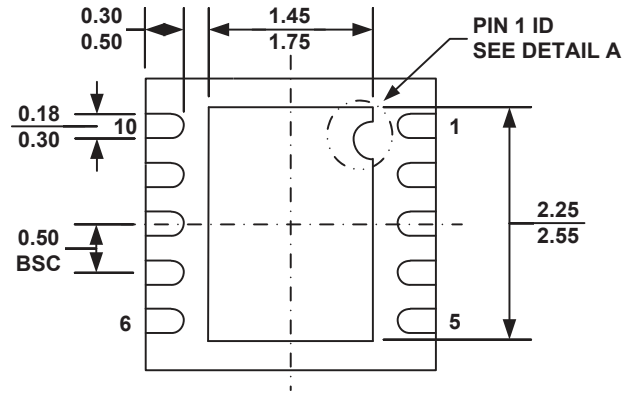

**BOTTOM VIEW**

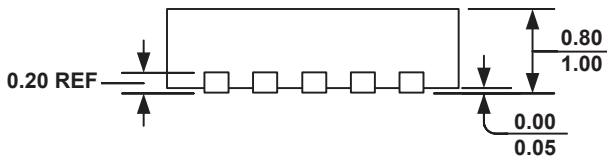

**SIDE VIEW**

**PIN 1 ID OPTION A**  
R0.20 TYP.

**PIN 1 ID OPTION B**  
R0.20 TYP.



**DETAIL A**

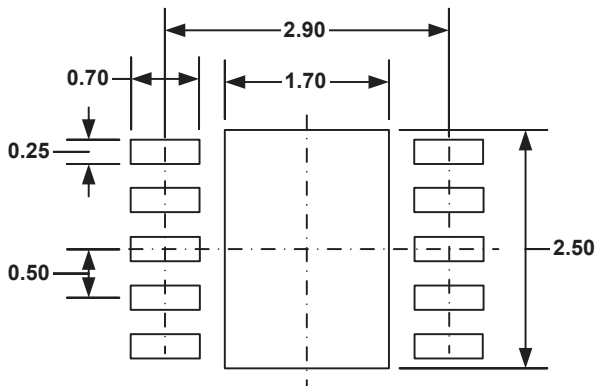

**RECOMMENDED LAND PATTERN**

#### NOTE:

- 1) ALL DIMENSIONS ARE IN MILLIMETERS.
- 2) EXPOSED PADDLE SIZE DOES NOT INCLUDE MOLD FLASH.
- 3) LEAD COPLANARITY SHALL BE 0.10 MILLIMETER MAX.
- 4) DRAWING CONFORMS TO JEDEC MO-229, VARIATION VEED-5.
- 5) DRAWING IS NOT TO SCALE.

**NOTICE:** The information in this document is subject to change without notice. Please contact MPS for current specifications. Users should warrant and guarantee that third party Intellectual Property rights are not infringed upon when integrating MPS products into any application. MPS will not assume any legal responsibility for any said applications.