

**RoHS
Compliant**



Description

brick fuse for the small size and good electrical performance, reliability and quality. The solder-free design provides excellent on-off and temperature cycling characteristics during use and also makes our brick fuses more heat and shock tolerant than typical brick fuses.

Applications

Used in notebook PC, telecom system, LCD/PDP TV, wireless goods, LCD monitor, white goods, LCD/PDP panel, game console, power supply, net working and other electronics products.

Features

- Rapid interruption of excessive current
- Compatible with reflow and wave soldering
- Ceramic body and silver plated copper terminal
- Excellent environmental integrity
- One time positive disconnect
- Lead-free and Halogen-free
- Designed to UL 248-14

Specifications

Operating Temperature	: -55°C to +125°C
Storage Conditions	: +10°C to +60°C
Relative Humidity	: ≤75% yearly average without dew, maximum 30 days at 95%
Vibration Resistance	: 24 cycles at 15 min. each 10-60Hz at 0.75mm amplitude 60-2000Hz at 10g acceleration

Electrical Characteristics

Time vs Current Characteristics Table

(measured with constant current power supply)

Time vs Current Characteristics		
Rated current	100%	200%
0.25A to 1.5A	>4h	<5s

Average Time Current (I-T) Curves

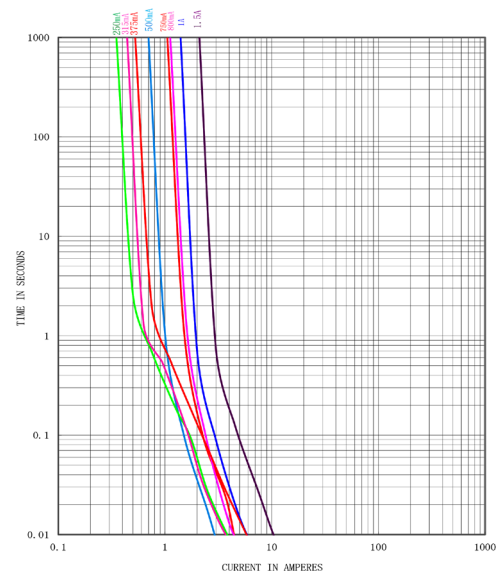

Electrical Characteristics at 25°C

Amp Code	Rated Current	Rated Voltage DC	Typical Voltage Drop (mV)	Breaking Capacity	Typical Melting I ² T (A ² s)	Typ. Cold Resistance (mΩ)
0250	0.25A	125V AC 125V DC	300	100A@125V AC 50A@125V DC	0.144	519.4~964.6
0315	0.315A		300		0.137	361.2~670.8
0375	0.375A		300		0.335	275.1~510.9
0500	0.5A		600		0.090	520.1~965.9
0750	0.75A		500		0.160	280.7~521.3
0800	0.8A		500		0.203	238.7~443.3
1100	1A		500		0.900	172.9~321.1
1150	1.5A		350		1.069	100.8~187.2

Note:

- (1) Permissible continuous operating current is ≤100% at ambient temperature of 23°C (73.4°F).
- (2) The current values used for calculating I²T should be 8~10ms.
- (3) The product without sand when the current is no more than 0.375A.

Temperature Re-rating Curve

Temperature Derating Curve

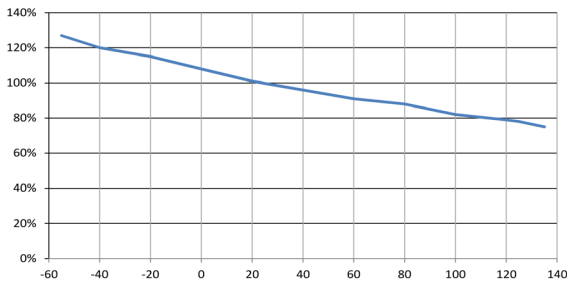

Calculation for ideal fuse selection = $\frac{\text{Operating Current (A)}}{\text{Rating (\% 0.75)}}$

Soldering Parameters

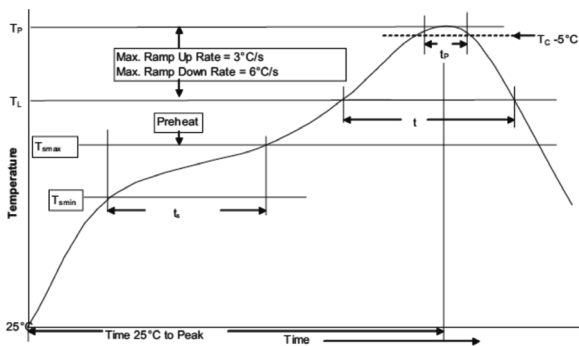

1. Infrared Reflow:
 - Temperature: 260°C
 - Time: 30sec Max.
 - Recommend reflow profile
2. Wave Soldering:
 - Reservoir Temperature: 260°C
 - Time in Reservoir: 10sec Max.

Profile Feature		Pb-Free Assembly
Average Ramp-UP Rate(Tsmax to Tp)		3°C/s Max.
Preheat	Temperature Min (Ts min)	150°C
	Temperature Max (Ts max)	200°C
	Time (Tsm in to Ts max)	60sec to 120sec
Liquidous temperature(TL)		217°C
Time at liquidous(tL)		60 to 150S
Peak package body temperature (Tp)		260°C
Time (tP) within 5°C of the specified classification temperature (Tc)		30S
Average ramp-down rate (Tp to Tsmax)		6°C/s Max.
Time (25°C to Peak Temperature)		8 Minutes Max.

Mechanical Specifications

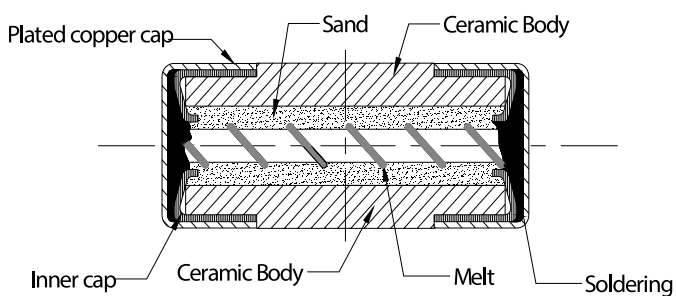

Diagram

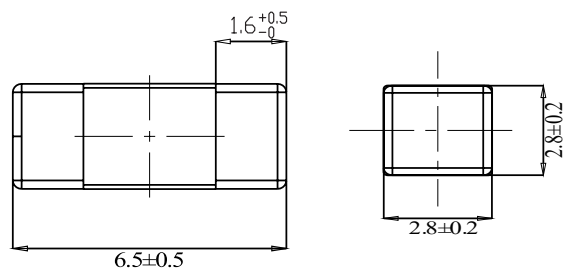

Recommended Land Pattern

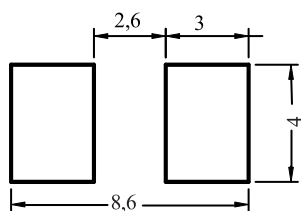

Dimensions : Millimetres

Packing Information

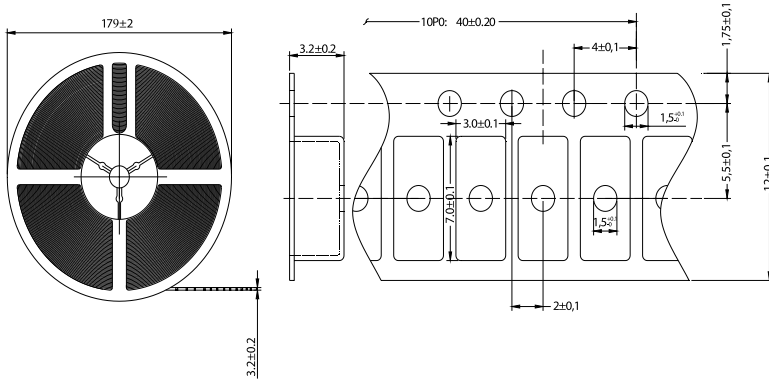

Part Number Table

Description	Part Number
SMD Fuse, 2410, Fast Blow, 0.25A	MCCFB2410TFF/250
SMD Fuse, 2410, Fast Blow, 0.315A	MCCFB2410TFF/315
SMD Fuse, 2410, Fast Blow, 0.375A	MCCFB2410TFF/C/375
SMD Fuse, 2410, Fast Blow, 0.5A	MCCFB2410TFF/500
SMD Fuse, 2410, Fast Blow, 0.5A	MCCFB2410TFF/C/500
SMD Fuse, 2410, Fast Blow, 0.75A	MCCFB2410TFF/750
SMD Fuse, 2410, Fast Blow, 0.8A	MCCFB2410TFF/800
SMD Fuse, 2410, Fast Blow, 1A	MCCFB2410TFF/1
SMD Fuse, 2410, Fast Blow, 1A	MCCFB2410TFF/C/1
SMD Fuse, 2410, Fast Blow, 1.5A	MCCFB2410TFF/C/1.5
SMD Fuse, 2410, Fast Blow, 1.5A	MCCFB2410TFF/1.5

Dimensions : Millimetres

Important Notice : This data sheet and its contents (the "Information") belong to the members of the AVNET group of companies (the "Group") or are licensed to it. No licence is granted for the use of it other than for information purposes in connection with the products to which it relates. No licence of any intellectual property rights is granted. The Information is subject to change without notice and replaces all data sheets previously supplied. The Information supplied is believed to be accurate but the Group assumes no responsibility for its accuracy or completeness, any error in or omission from it or for any use made of it. Users of this data sheet should check for themselves the Information and the suitability of the products for their purpose and not make any assumptions based on information included or omitted. Liability for loss or damage resulting from any reliance on the Information or use of it (including liability resulting from negligence or where the Group was aware of the possibility of such loss or damage arising) is excluded. This will not operate to limit or restrict the Group's liability for death or personal injury resulting from its negligence. Multicomp Pro is the registered trademark of Premier Farnell Limited 2019.