



# MASTER LEDspot ExpertColor LV

## MASTER LED ExpertColor 6.7-35W MR16 927 24D

MASTER LEDspot LV ExpertColor creates a warm and comfortable ambience for hospitality venues, homes and restaurants. It creates such an ambience with superior lighting that has a customised spectrum, high CRI and deep dimming feature. The result? A beautiful lighting experience. What's more, the innovative, trimless lens design will suit almost any interior decor with its clean and neat look. In addition, you can take advantage of the full ExpertColor family, which also includes LEDspot MV lamps.

### Product data

General Information	
Cap base	GU5.3 [ GU5.3]
EU RoHS compliant	Yes
Nominal lifetime (nom.)	40000 h
Switching cycle	50,000X
	Narrow Cone
Light Technical	
Colour Code	927 [ CCT of 2,700 K]
Beam Angle (Nom)	24°
Luminous flux (nom.)	420 lm
Luminous intensity (nom.)	2100 cd
Colour designation	Warm white (WW)
Correlated Colour Temperature (Nom)	2700 K
Luminous efficacy (rated) (nom.)	62.00 lm/W
Colour consistency	<3
Colour rendering index (nom.)	97
LLMF at end of nominal lifetime (nom.)	70 %

Luminous flux in 90° cone (rated)	420 lm
Operating and Electrical	
Input frequency	- Hz
Power (Rated) (Nom)	6.7 W
Lamp current (nom.)	650 mA
Wattage equivalent	35 W
Starting time (nom.)	0.5 s
Warm-up time to 60% light (nom.)	0.5 s
Power factor (nom.)	0.7
Voltage (Nom)	ac electronic 12 V
Temperature	
T-Case maximum (nom.)	92 °C
Controls and Dimming	
Dimmable	Only with specific dimmers

# MASTER LEDspot ExpertColor LV

## Mechanical and Housing

Bulb shape MR16 [ 2inch/50mm]

## Approval and Application

Energy Efficiency Class G

Suitable for accent lighting Yes

Energy consumption kWh/1,000 hours 7 kWh

624217

## Product Data

Full product code 871951435853900

Order product name MASTER LED ExpertColor 6.7-35W MR16 927 24D

EAN/UPC – product 8719514358539

Order code 35853900

SAP numerator – quantity per pack 1

Numerator – packs per outer box 10

SAP material 929003079102

SAP net weight (piece) 0.052 kg

## Dimensional drawing

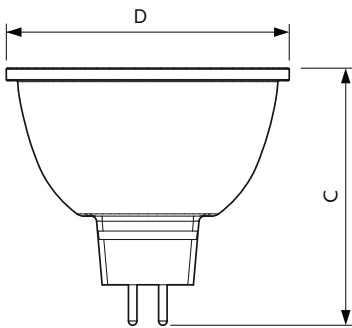

MR16 12V 6.5-35W 450lm 24D 2700K GU5.3 D

Product	D	C
MASTER LED ExpertColor 6.7-35W MR16 927 24D	50.5 mm	46 mm

## Photometric data

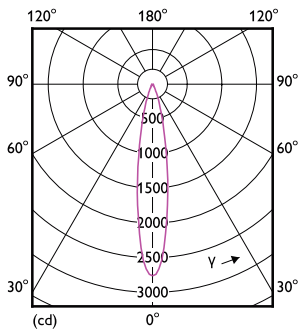

LEDspots MAS IC 6,7W MR16 GU5,3 927 24D-LDD

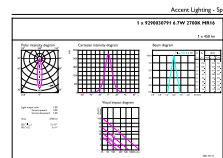

LEDspots MAS IC 6,7W MR16 GU5,3 927 24D-ADL

# MASTER LEDspot ExpertColor LV

## Photometric data

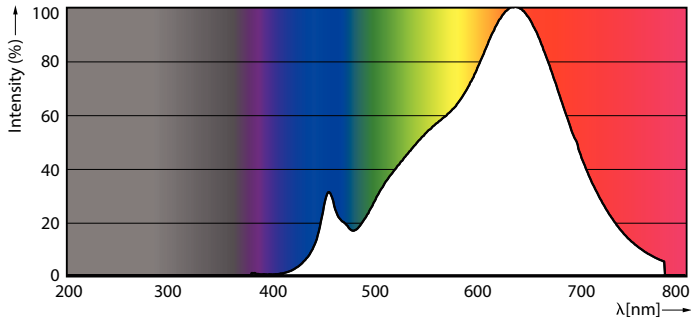

LEDspots MAS IC 6,7W MR16 GU5,3 927 60D-POC

## Lifetime

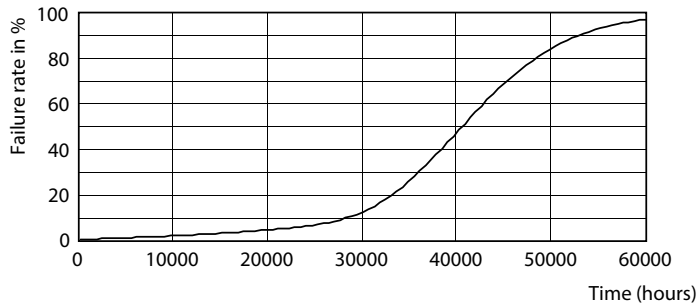

LEDspots LED 40K

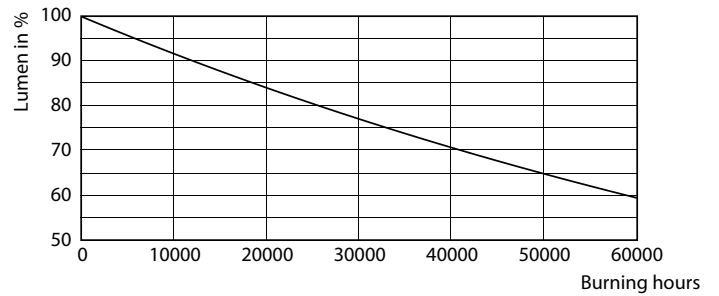

LEDspots LMP 40K

