



HPI

TE Internal #: 1-2380312-3

HPI, Housing, Receptacle, Wire-to-Board, 13 Position, 1.5 mm [.059 in] Centerline, Crimp, 1 Row, Natural, Mating Retention, Wire & Cable

[View on TE.com >](#)

Connectors > PCB Connectors > Wire-to-Board Connectors > Wire-to-Board Connector Assemblies & Housings

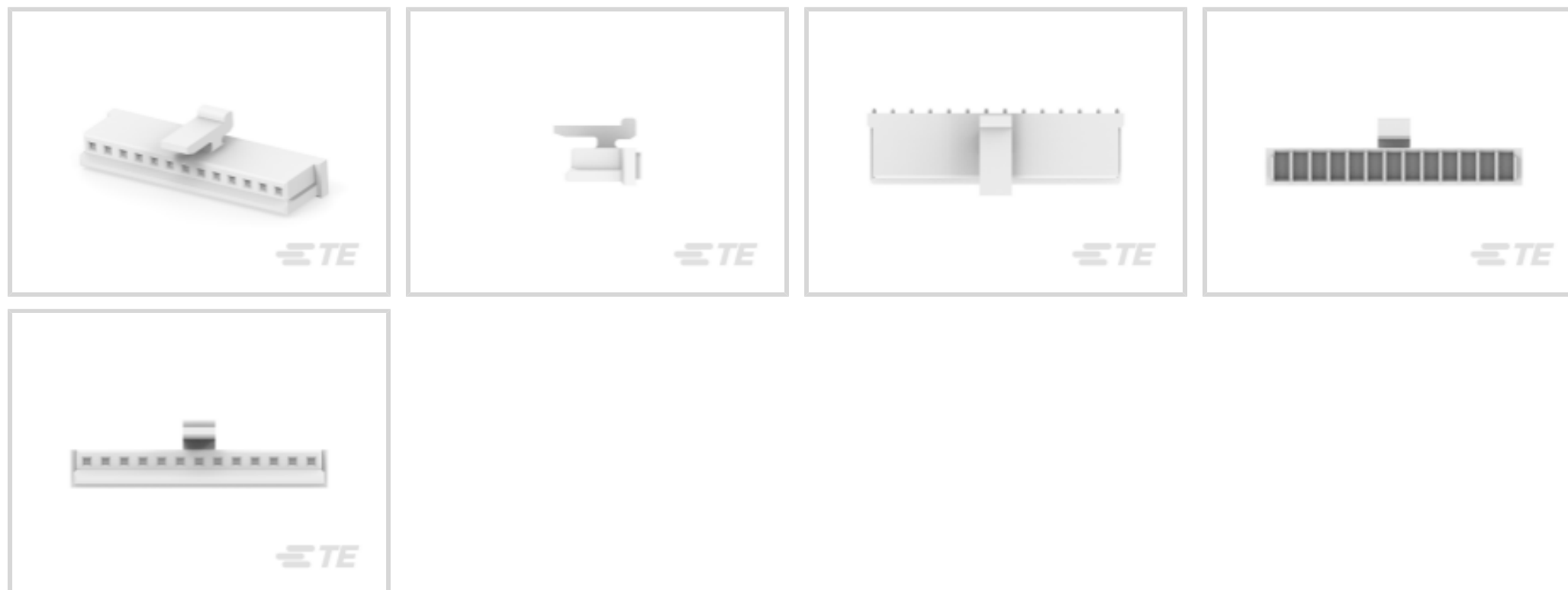

Connector Product Type: **Housing**

Connector & Housing Type: **Receptacle**

Connector System: **Wire-to-Board**

Number of Positions: **13**

Centerline (Pitch): **1.5 mm [.059 in]**

Features

Product Type Features

Connector Product Type	Housing
Connector & Housing Type	Receptacle
Connector System	Wire-to-Board
Sealable	No
Connector & Contact Terminates To	Wire & Cable

Configuration Features

Number of Positions	13
Number of Rows	1

Electrical Characteristics

Termination Resistance	20 mΩ
Dielectric Withstanding Voltage (Max)	500 VAC
Insulation Resistance	1000 MΩ
Operating Voltage	50 V

Contact Features



Contact Current Rating (Max)	3 A
------------------------------	-----

Termination Features

Termination Method to Wire & Cable	Crimp
------------------------------------	-------

Mechanical Attachment

Strain Relief	Without
---------------	---------

Panel Mount Feature	Without
---------------------	---------

PCB Mount Retention	Without
---------------------	---------

Mating Retention	With
------------------	------

Connector Mounting Type	Cable Mount (Free-Hanging)
-------------------------	----------------------------

Housing Features

Housing Entry Configuration	Both Ends Closed
-----------------------------	------------------

Housing Material	66 Nylon
------------------	----------

Centerline (Pitch)	1.5 mm [.059 in]
--------------------	------------------

Housing Color	Natural
---------------	---------

Dimensions

Accepts Wire Insulation Diameter Range	.7 – 1.1 mm
--	-------------

Wire Size	.05 – .2 mm ²
-----------	--------------------------

Usage Conditions

Operating Temperature Range	-40 – 105 °C [-40 – 221 °F]
-----------------------------	-----------------------------

Operation/Application

Circuit Application	Power & Signal
---------------------	----------------

Industry Standards

Glow Wire Rating	Standard Part - Not Glow Wire
------------------	-------------------------------

UL Flammability Rating	UL 94V-0
------------------------	----------

Packaging Features

Packaging Quantity	20000
--------------------	-------

Packaging Method	Bag & Box
------------------	-----------

Product Compliance

[For compliance documentation, visit the product page on TE.com>](#)

EU RoHS Directive 2011/65/EU	Compliant with Exemptions
------------------------------	---------------------------



EU ELV Directive 2000/53/EC

Not Yet Reviewed

China RoHS 2 Directive MIIT Order No 32, 2016

Restricted Materials Above Threshold

EU REACH Regulation (EC) No. 1907/2006

Current ECHA Candidate List: JAN 2022 (223)

Candidate List Declared Against: JUL 2021 (219)

SVHC > Threshold:

Pb (4% in Component Part)

Article Safe Usage Statements:

Do not eat, drink or smoke when using this product. Wash thoroughly after handling. Recycle if possible and dispose of the article by following all applicable governmental regulations relevant to your geographic location.

Halogen Content

Low Halogen - Br, Cl, F, I < 900 ppm per homogenous material. Also BFR/CFR/PVC Free

Solder Process Capability

Not reviewed for solder process capability

Product Compliance Disclaimer

This information is provided based on reasonable inquiry of our suppliers and represents our current actual knowledge based on the information they provided. This information is subject to change. The part numbers that TE has identified as EU RoHS compliant have a maximum concentration of 0.1% by weight in homogenous materials for lead, hexavalent chromium, mercury, PBB, PBDE, DBP, BBP, DEHP, DIBP, and 0.01% for cadmium, or qualify for an exemption to these limits as defined in the Annexes of Directive 2011/65/EU (RoHS2). Finished electrical and electronic equipment products will be CE marked as required by Directive 2011/65/EU. Components may not be CE marked. Additionally, the part numbers that TE has identified as EU ELV compliant have a maximum concentration of 0.1% by weight in homogenous materials for lead, hexavalent chromium, and mercury, and 0.01% for cadmium, or qualify for an exemption to these limits as defined in the Annexes of Directive 2000/53/EC (ELV). Regarding the REACH Regulation, the information TE provides on SVHC in articles for this part number is based on the latest European Chemicals Agency (ECHA) 'Guidance on requirements for substances in articles' posted at this URL: <https://echa.europa.eu/guidance-documents/guidance-on-reach>

Compatible Parts



TE Part # 1-2380320-3
1.5P 13POS WTB VERT BRD W LATCH
TIN NAT



TE Part # 1-2381626-3
1.5P 13POS WTB R/A BRD W LATCH
TIN NAT



TE Part # 2380403-2
1.5P WTB CABLE CRIMP CONTACT
GOLD PLT

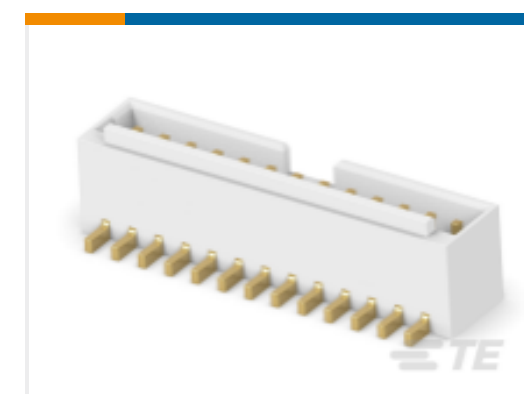

TE Part # 3-2380320-3
1.5P 13POS WTB VERT BRD W LATCH
AU NAT



TE Part # 3-2381626-3
1.5P 13POS WTB R/A BRD W LATCH
AU NAT



TE Part # 5-2380320-3
1.5P 13POS WTB VERT BRD W LATCH
TIN BL



TE Part # 5-2381626-3
1.5P 13POS WTB R/A BRD W LATCH
TIN BLACK



TE Part # 7-2380320-3
1.5P 13POS WTB VERT BRD W LATCH
AU BLACK



Also in the Series | HPI

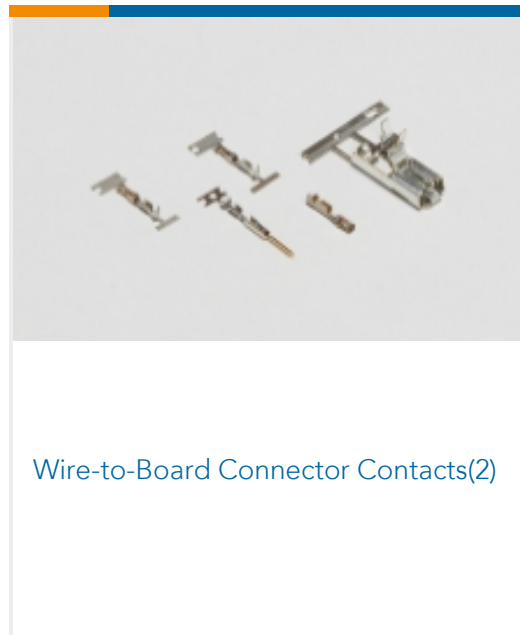
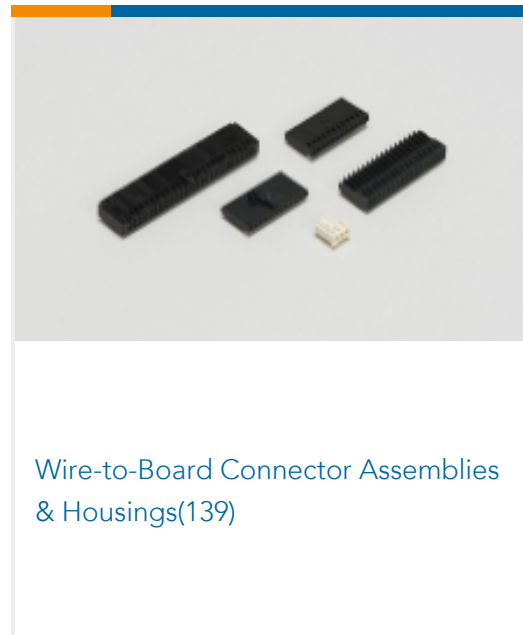

Customers Also Bought

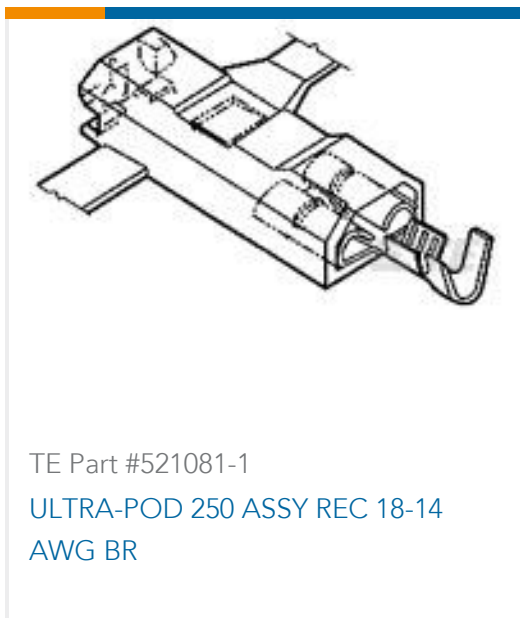



Documents

CAD Files

3D PDF

3D

Customer View Model

[ENG_CVM_CVM_1-2380312-3_1.2d_dxf.zip](#)

English

Customer View Model

[ENG_CVM_CVM_1-2380312-3_1.3d_igs.zip](#)

English

Customer View Model

[ENG_CVM_CVM_1-2380312-3_1.3d_stp.zip](#)

English

By downloading the CAD file I accept and agree to the [Terms and Conditions](#) of use.

Product Specifications

Product Specification

English