



## Product / Process Change Notification (PCN)

- Major change  
 Minor change

<p><b>PCN #:</b> PCN_UtRJ45LAN_20220525</p> <p><b>Affected Series:</b> WE-UtRJ45LAN; 7499xxx; S1xxx</p> <p><b>PCN Date:</b> February 25, 2022</p> <p><b>Effective Date:</b> May 25, 2022</p>	<p><b>Change Category:</b></p> <p><input type="checkbox"/> Equipment / Location</p> <p><input type="checkbox"/> General Data</p> <p><input type="checkbox"/> Material</p> <p><input type="checkbox"/> Process</p> <p><input checked="" type="checkbox"/> Product Design</p> <p><input type="checkbox"/> Shipping / Packaging</p> <p><input type="checkbox"/> Supplier</p> <p><input type="checkbox"/> Software</p>
<p><b>Contact:</b> Product Management</p> <p><b>Phone:</b> +49 (0) 7942 - 945 5001</p> <p><b>Fax:</b> +49 (0) 7942 - 945 5179</p> <p><b>E-Mail:</b> pcn.eisos@we-online.com</p>	<p><b>Data Sheet Change:</b></p> <p><input checked="" type="checkbox"/> Yes      <input type="checkbox"/> No</p> <p><b>Attachment:</b></p> <p><input type="checkbox"/> Yes      <input checked="" type="checkbox"/> No</p>

**Description and purpose of change:**

To ensure an improved product assembly, Würth Elektronik will implement a new spot welding design technology. Along with this, further general improvements are done in design and process, like shield plating or wire to shield insulation.

Additional Würth Elektronik will change to new data sheet format, correct datasheet mismatches & change dimensions from max-value to tolerance-value.

All products with date code 2022-05-25 or later, will be affected by this change.

There will be no change in fit, function or quality of the product.

**Detail of Change:**

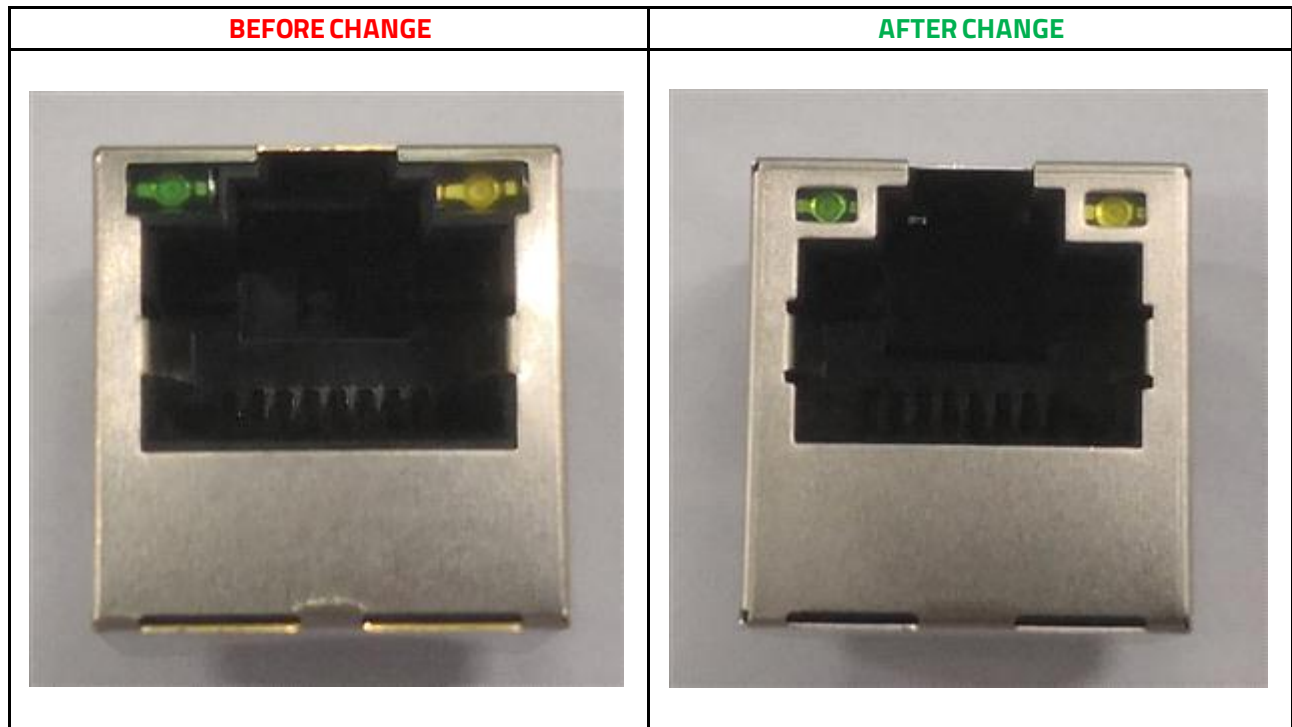

**Above:** The shield of the RJ45 is covering the LEDs.

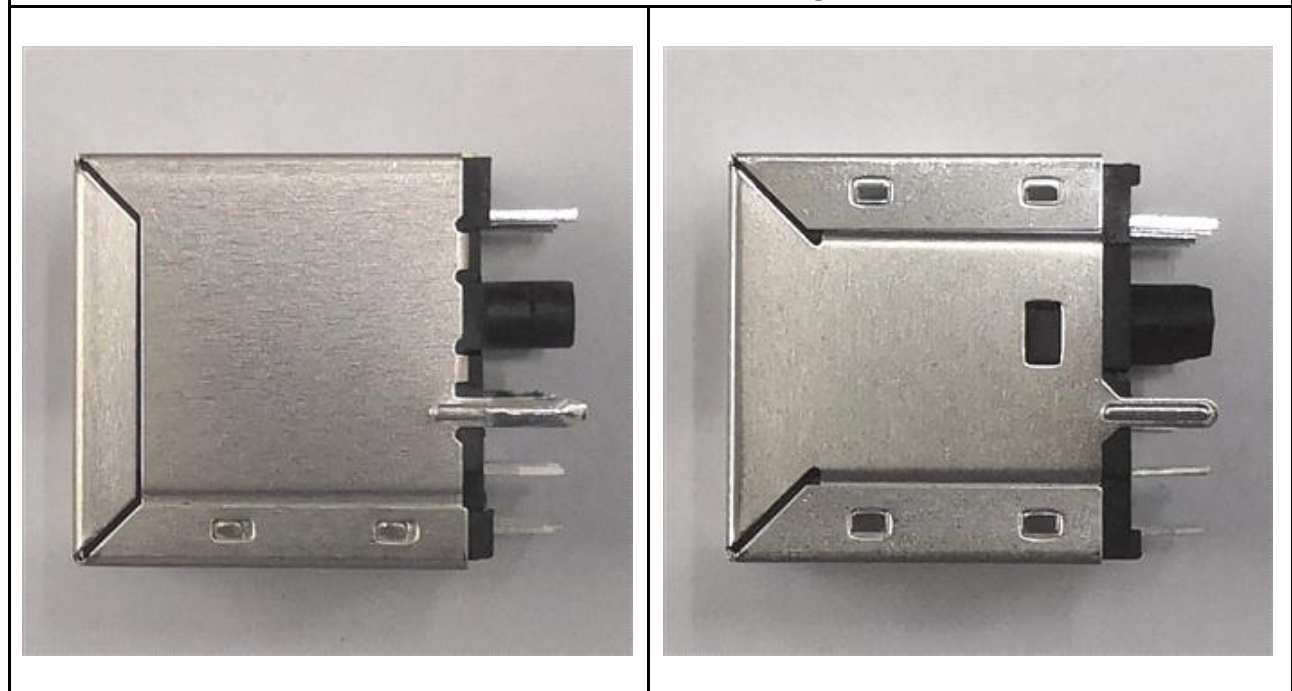

**Above:** The RJ45 shield will be closed on both sides while assembly to make the assembly easier.

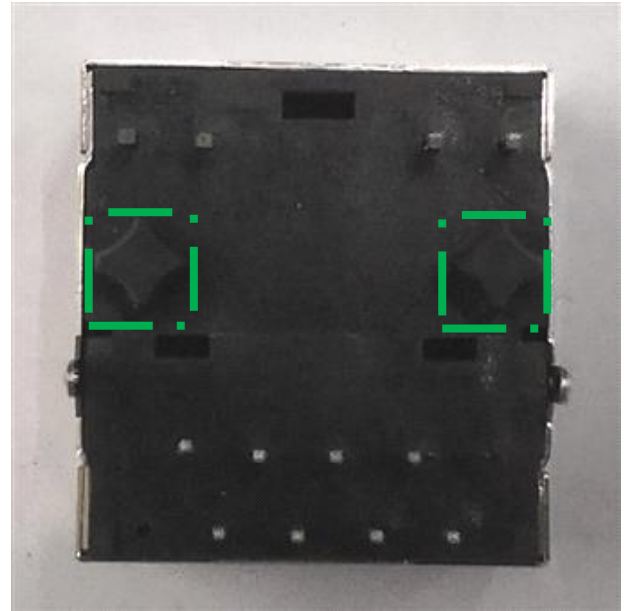
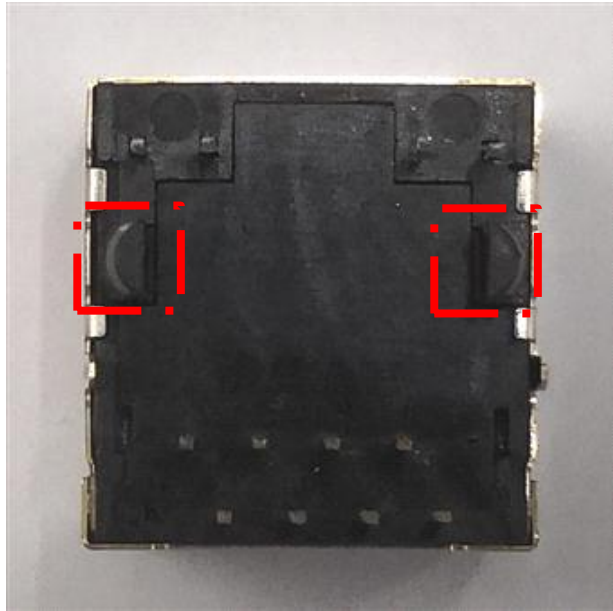

**Above:** The bottom plastic pins are even more robust after change.

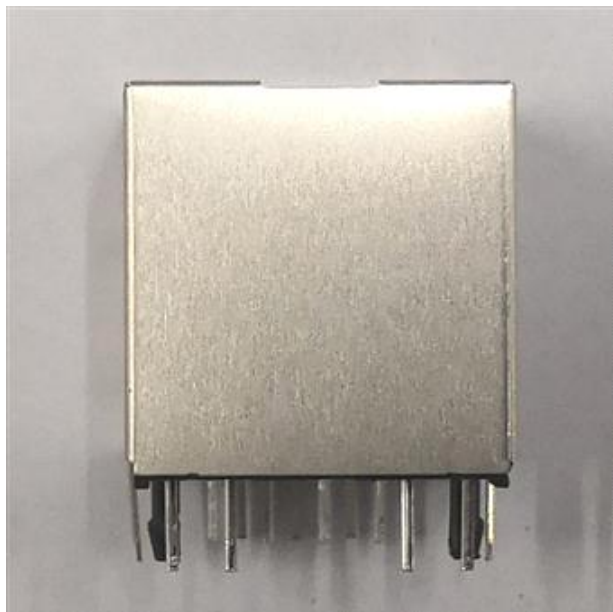

Content	Specification
Transformer core (T1)	3.43x1.78x2.06 mm
CMC core (T2)	2.64x1.40x1.27 mm
Wire	0.10mm QPN
Turns	12T+10T

Content	Specification
Transformer core (T1)	3.05x1.78x2.06 mm
CMC core (T2)	2.64x1.40x1.27 mm
Wire	0.09mm QPN
Turns	14T+10T

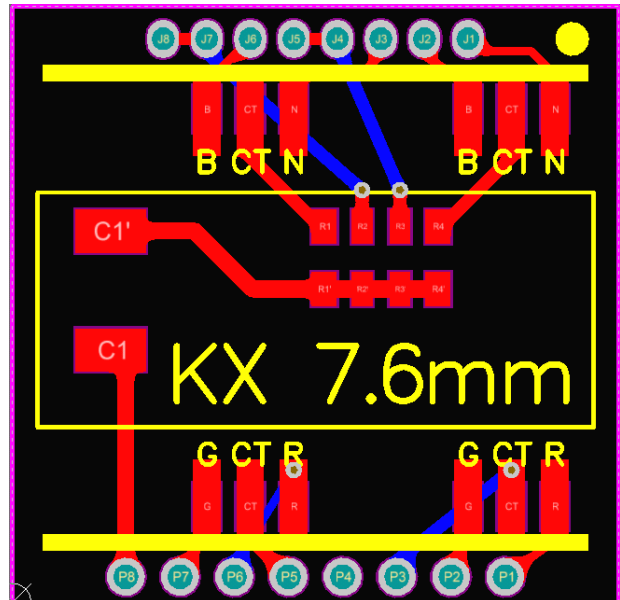
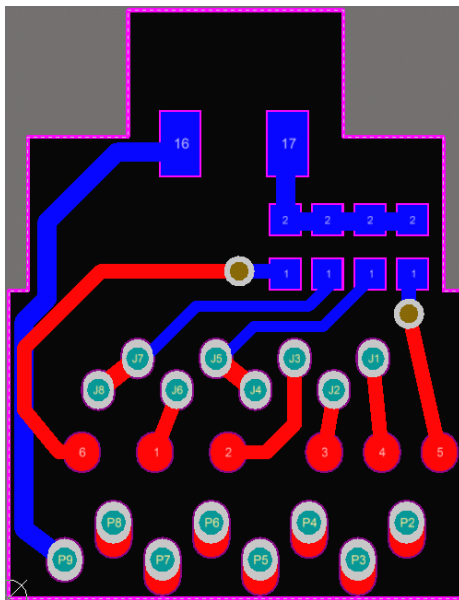

**Coils are manually soldered**

**Coils are welded by automatic spot welding**

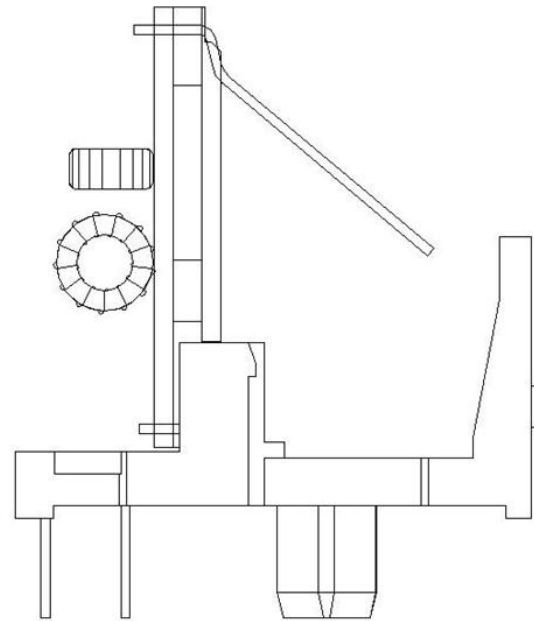
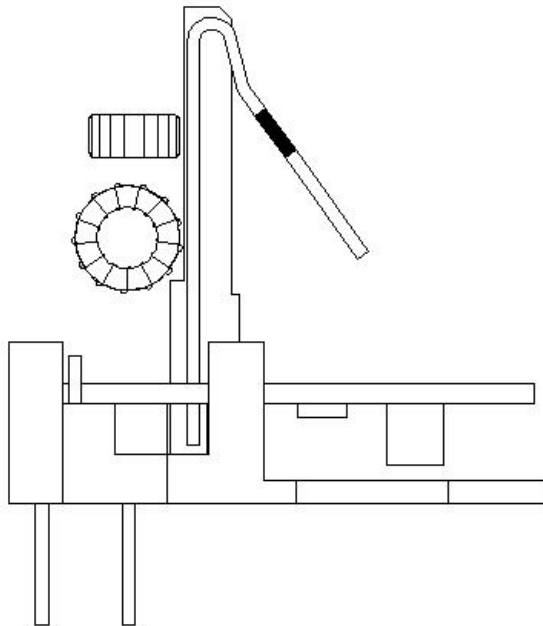

**Above:** Improved positioning of the PCB.

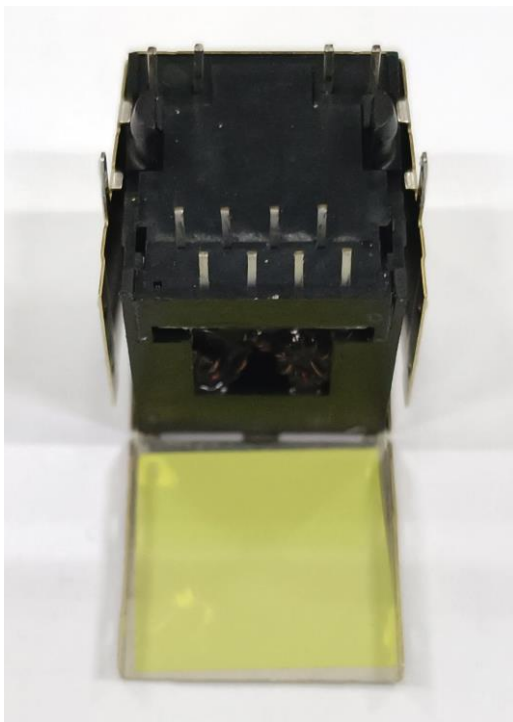

**Above:** Using a plastic plate instead of a thin tape to separate cores from Shielding.

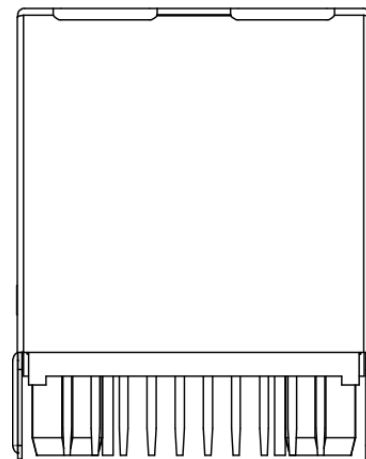
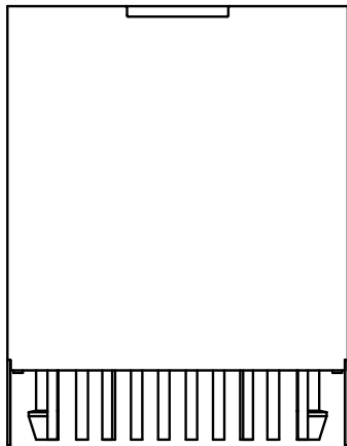

**Above:** The pin shape will change from straight to sharp, to ensure easier assembly.

Additional the following points will be corrected for different article numbers due to standardization:

7499010129:

**BEFORE CORRECTION**

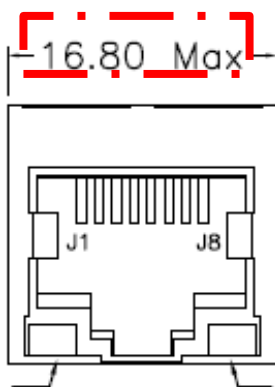

**AFTER CORRECTION**

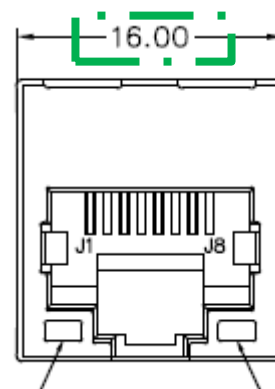

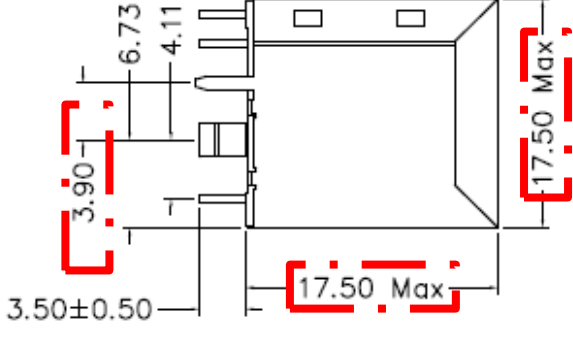
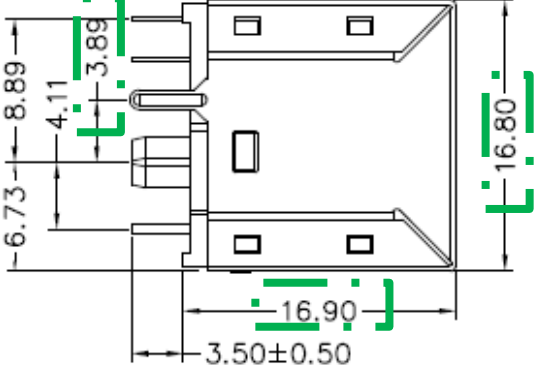
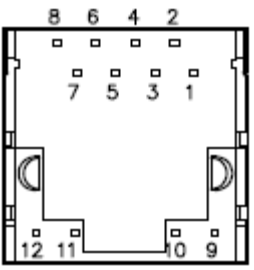
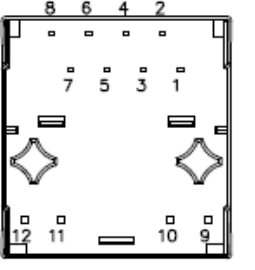
	
	
<p>Dielectric Rating: 1500 Vrms</p>	<p>Dielectric Rating: 2250 VDC</p>
<p>Return Loss:        1 – 10 MHz        10 – 30 MHz        30 – 60 MHz        60 – 80 MHz</p>	<p>Return Loss:        1 – 30 MHz        30 – 60 MHz        60 – 80 MHz        80 – 100 MHz</p>
<p>Common Mode Rejection:        1 – 100 MHz</p>	<p>Common Mode Rejection:        1 – 30 MHz        30 – 60 MHz        60 – 100 MHz</p>
<p>Crosstalk:        1 – 100 MHz</p>	<p>Crosstalk:        1 – 60 MHz        60 – 100 MHz</p>

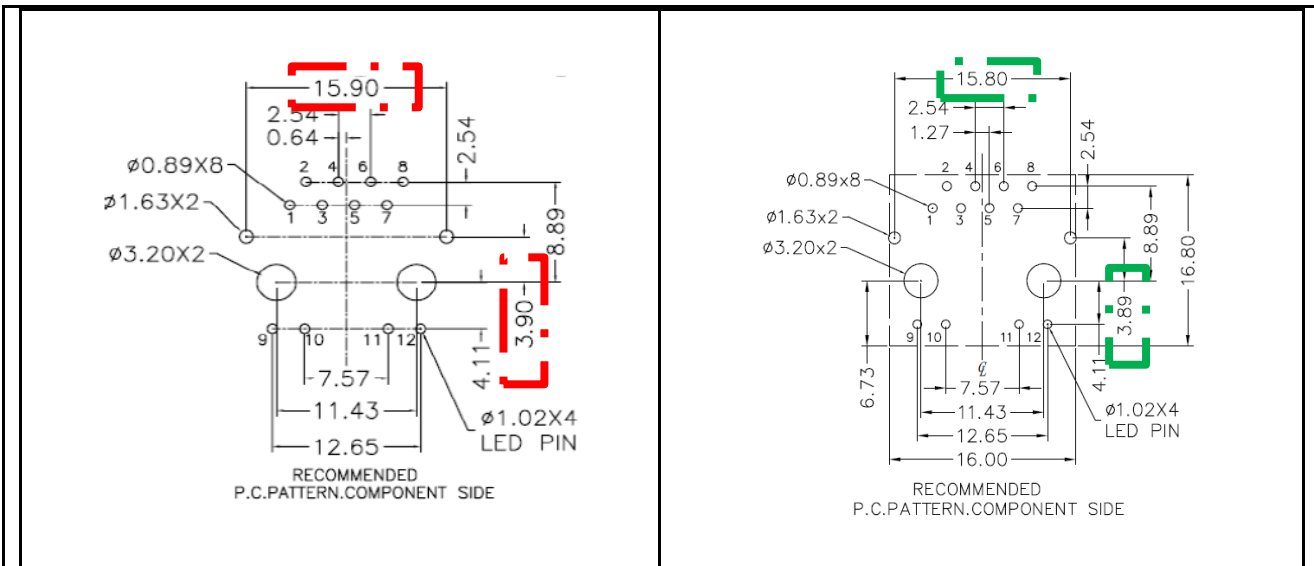

74990101210:

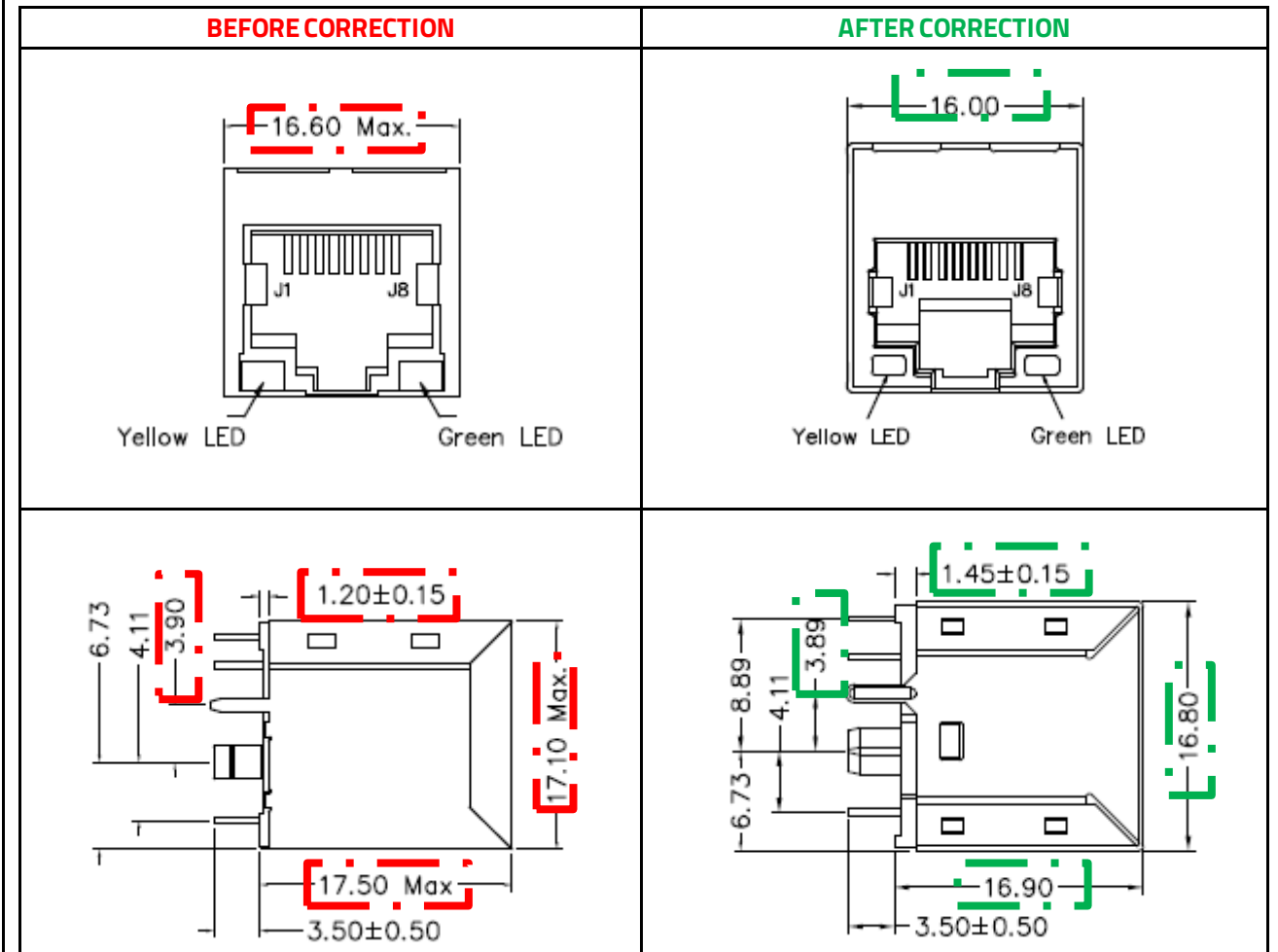

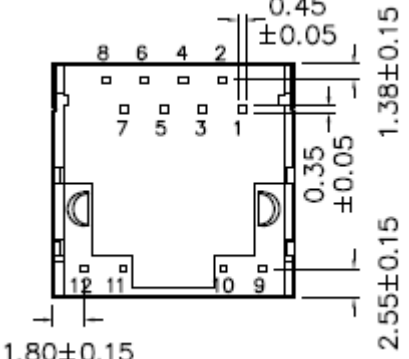
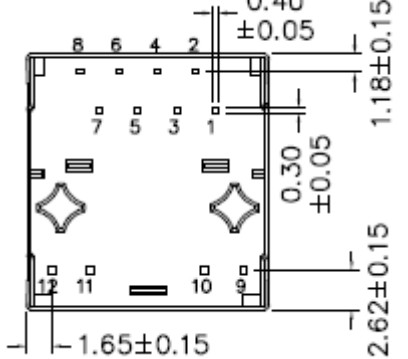
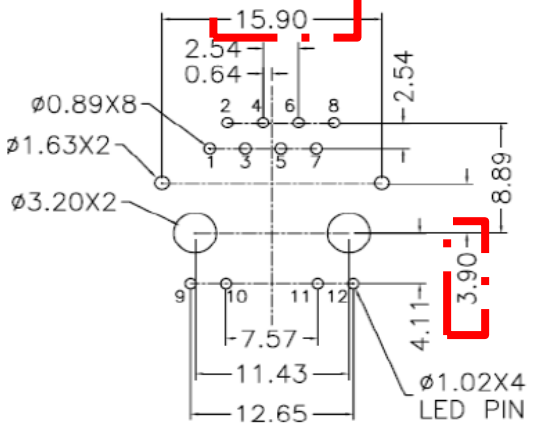
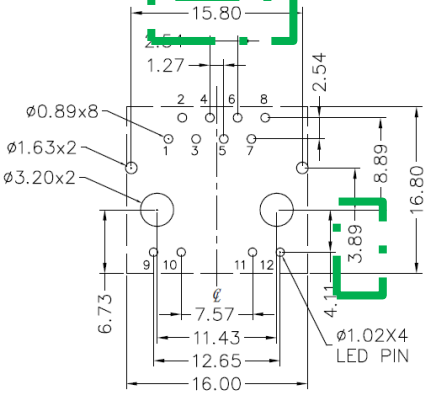

	
<p>Dielectric Rating: 1500 Vrms</p>	<p>Dielectric Rating: 2250 VDC</p>
<p>Return Loss:              1 – 10 MHz              10 – 30 MHz              30 – 60 MHz              60 – 80 MHz</p>	<p>Return Loss:              1 – 30 MHz              30 – 60 MHz              60 – 80 MHz              80 – 100 MHz</p>
<p>Common Mode Rejection:              1 – 100 MHz</p>	<p>Common Mode Rejection:              1 – 30 MHz              30 – 60 MHz              60 – 100 MHz</p>
<p>Crosstalk:              1 – 100 MHz</p>	<p>Crosstalk:              1 – 60 MHz              60 – 100 MHz</p>
 <p>RECOMMENDED              P.C.PATTERN.COMPONENT SIDE</p>	 <p>RECOMMENDED              P.C.PATTERN.COMPONENT SIDE</p>

74990101241:

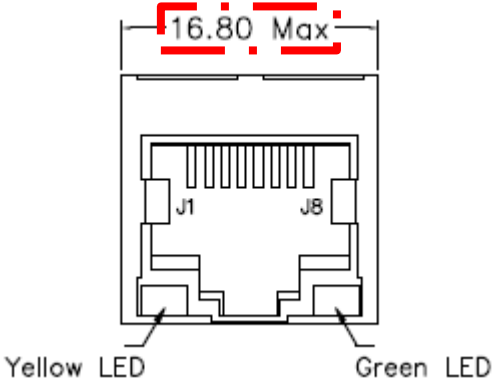
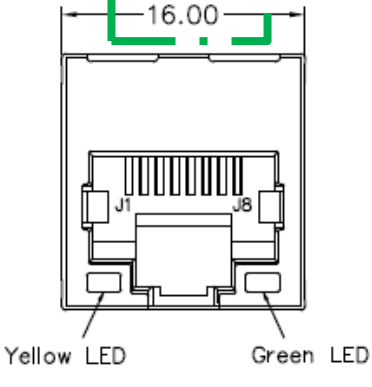
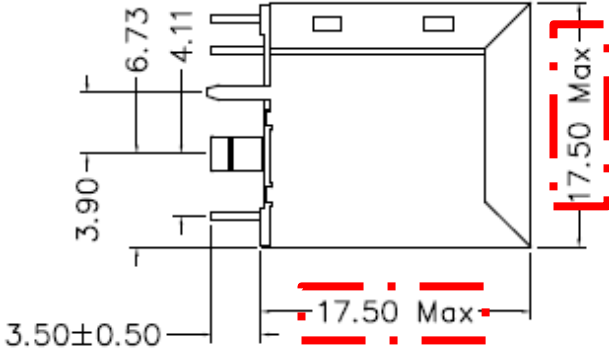
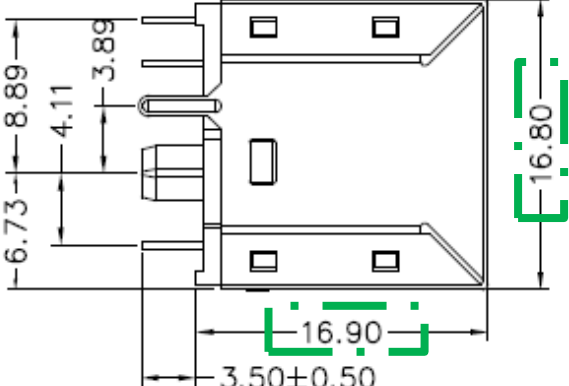
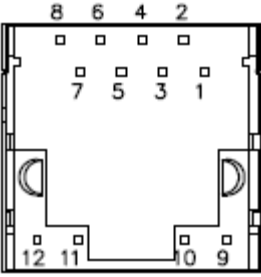
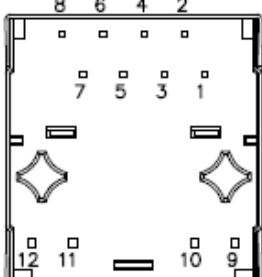
BEFORE CORRECTION	AFTER CORRECTION
 <p>16.80 Max</p> <p>J1 J8</p> <p>Yellow LED Green LED</p>	 <p>16.00</p> <p>J1 J8</p> <p>Yellow LED Green LED</p>
 <p>6.73 4.11 3.90 3.50±0.50</p> <p>17.50 Max 17.50 Max</p>	 <p>8.89 4.11 3.89 3.50±0.50</p> <p>16.80 16.90</p>
 <p>8 6 4 2 7 5 3 1 12 11 10 9</p>	 <p>8 6 4 2 7 5 3 1 12 11 10 9</p>
<p>Dielectric Rating: 1500 Vrms</p>	<p>Dielectric Rating: 2250 VDC</p>

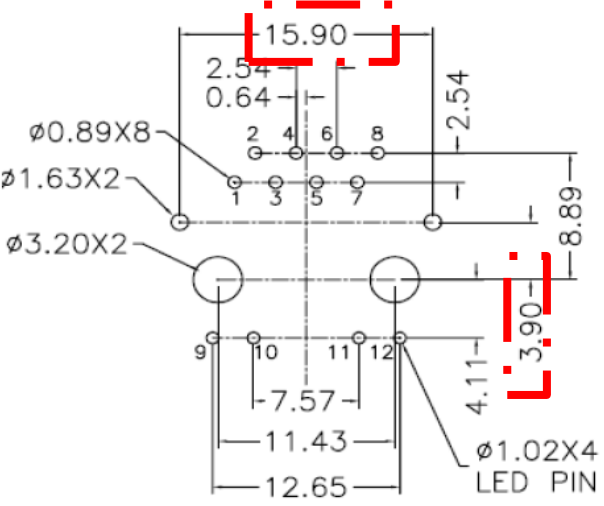
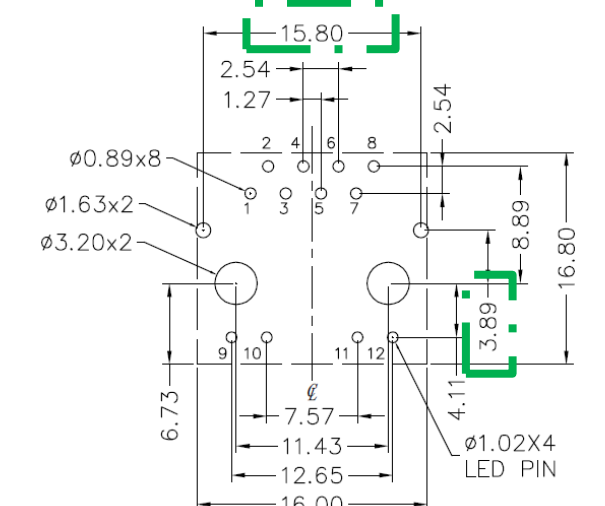
<p>Return Loss:                  1 – 30 MHz                  30 – 45 MHz                  45 – 60 MHz                  60 – 80 MHz</p>	<p>Return Loss:                  1 – 30 MHz                  30 – 60 MHz                  60 – 80 MHz                  80 – 100 MHz</p>
<p>Common Mode Rejection:                  1 – 100 MHz</p>	<p>Common Mode Rejection:                  1 – 30 MHz                  30 – 60 MHz                  60 – 100 MHz</p>
<p>Crosstalk:                  1 – 100 MHz</p>	<p>Crosstalk:                  1 – 60 MHz                  60 – 100 MHz</p>
 <p>RECOMMENDED                  P.C.PATTERN.COMPONENT SIDE</p>	 <p>RECOMMENDED                  P.C.PATTERN.COMPONENT SIDE</p>

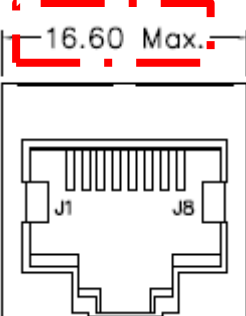
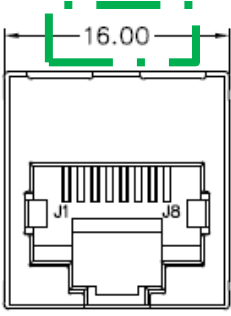
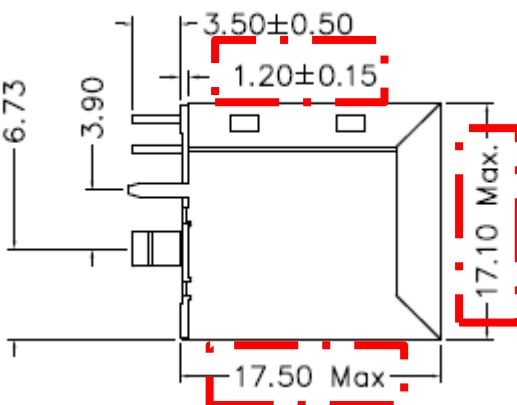
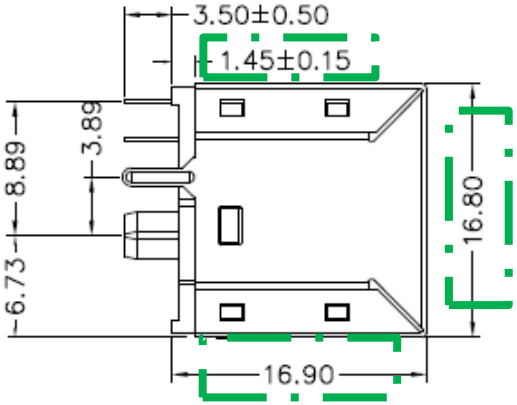
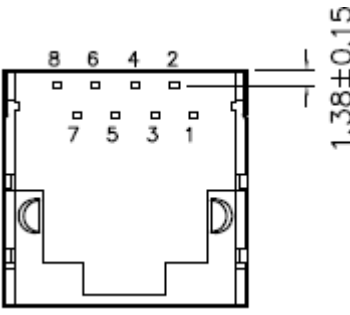
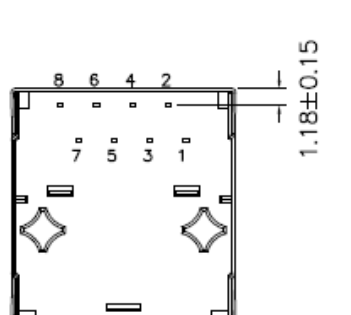
S16100131:	
BEFORE CORRECTION	AFTER CORRECTION
	
	
	
Dielectric Rating: 1500 Vrms	Dielectric Rating: 2250 VDC

Return Loss: 1 – 10 MHz 10 – 30 MHz 30 – 60 MHz 60 – 80 MHz	Return Loss: 1 – 30 MHz 30 – 60 MHz 60 – 80 MHz 80 – 100 MHz
Common Mode Rejection: 1 – 100 MHz	Common Mode Rejection: 1 – 30 MHz 30 – 60 MHz 60 – 100 MHz
Crosstalk: 1 – 100 MHz	Crosstalk: 1 – 60 MHz 60 – 100 MHz

S17100061:

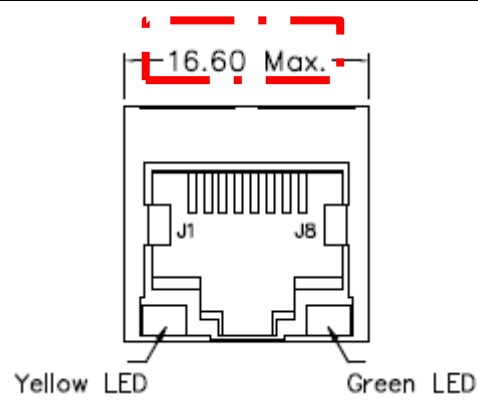
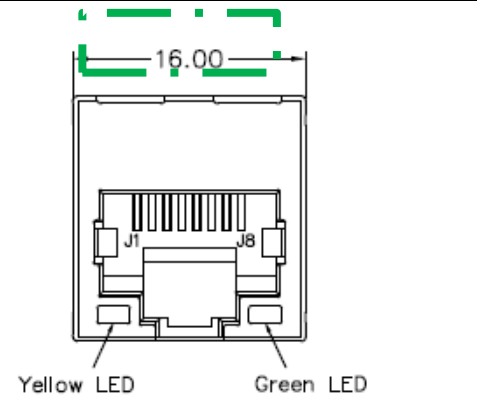
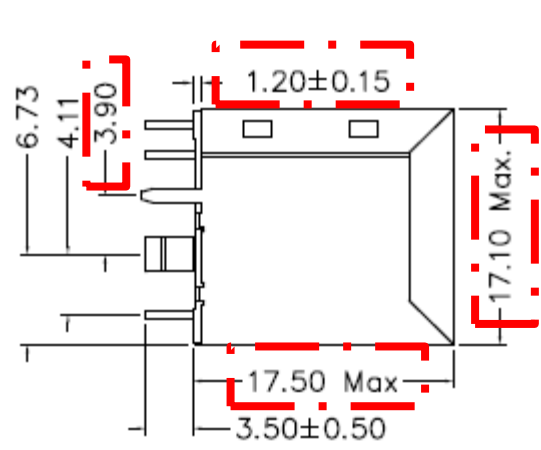
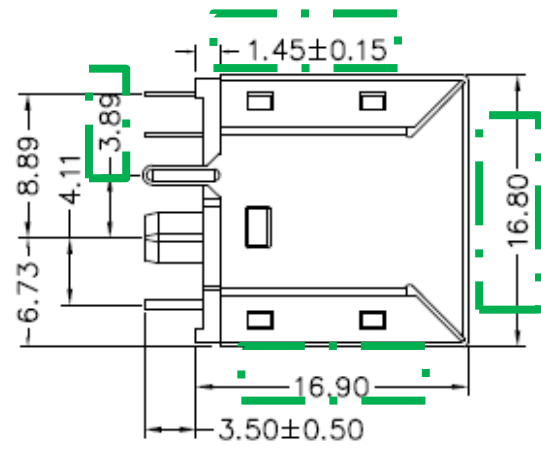
BEFORE CORRECTION	AFTER CORRECTION
 <p style="text-align: center;">16.60 Max.</p> <p style="text-align: center;">Yellow LED      Green LED</p>	 <p style="text-align: center;">16.00</p> <p style="text-align: center;">Yellow LED      Green LED</p>
 <p style="text-align: center;">6.73 4.11 3.90 1.20±0.15 17.10 Max. 17.50 Max. 3.50±0.50</p>	 <p style="text-align: center;">6.73 8.89 4.11 3.89 1.45±0.15 16.80 16.90 3.50±0.50</p>

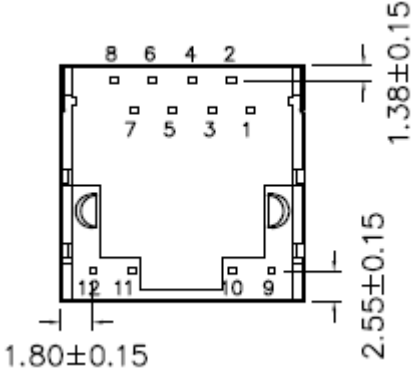
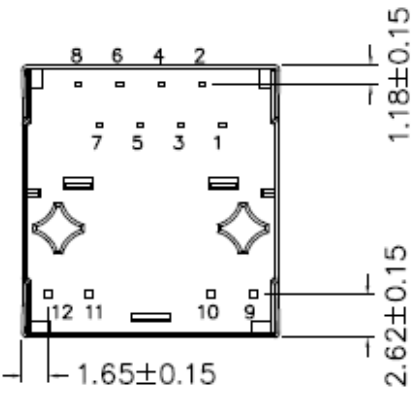
	
<p>Common Mode Rejection:          1 – 100 MHz</p>	<p>Common Mode Rejection:          1 – 30 MHz          30 – 60 MHz          60 – 100 MHz</p>
<p>Crosstalk:          1 – 100 MHz</p>	<p>Crosstalk:          1 – 60 MHz          60 – 100 MHz</p>
<p><b>Reliability / Qualification Summary:</b>          Thermal Shock – MIL-STD-202-107          Vibration – MIL-STD-202-204          Mating &amp; Un-mating – EIA-364-13D          Durability – EIA-364-09C          Moisture Resistance – MIL-STD-202-106</p>	