

**ROHDE & SCHWARZ**

Make ideas real



**R & S<sup>®</sup> ESSENTIALS**

# FUNDAMENTALS OF DC POWER SUPPLIES

Flyer | Version 01.00

In cooperation with



# OUTPUT CHARACTERISTICS



## DESIGN AND OPERATION

### Power supply designs

There are three basic types of power supplies based on different design principles:

- ▶ Linear power supplies
- ▶ Switched-mode power supplies (SMPS)
- ▶ Mixed architecture power supplies

### Linear power supplies

Linear regulated power supplies provide highly constant output voltage, low ripple and noise and fast regulation, even with high line and load transients. They produce significantly less electromagnetic interference than switched-mode power supplies.

A conventional mains transformer isolates the power-line from the secondary circuits (output stages). It is followed by a rectifier that supplies the unregulated voltage to a series actuator. Capacitors at the input and output of the regulator circuit serve as buffers and decrease the ripple. A high precision reference voltage controls the analog output amplifier. This amplifier is generally fast and allows very short recovery times for load changes.

### Linear power supply

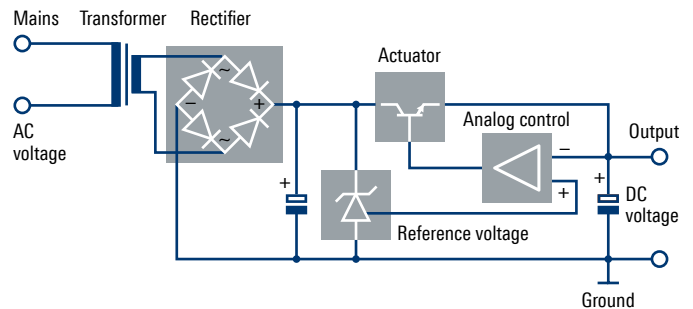

### Switched-mode power supplies (SMPS)

SMPS have much higher efficiency than linear regulated power supplies. In a first step, the line voltage is rectified. Due to the high input voltage, buffer capacitors with a small capacitance can be used. In a second step, the DC voltage to be converted is chopped at a high frequency. This takes place in the switching transistor and requires only comparatively tiny and light ferrite chokes or transformers with low losses. The switching transistor is switched fully on and off, hence switching losses are low. The output voltage is usually regulated by changing the duty cycle of the switching transistor. A rectifier and low-pass filter improve the output quality.

## Switched-mode power supply

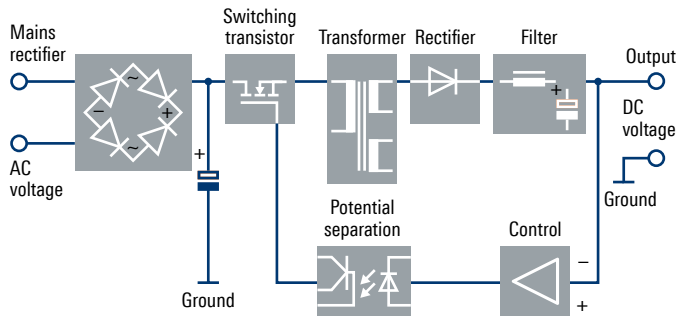

Compared to linear power supplies, SMPS achieve considerably higher efficiency of approx. 70% to over 95%. They are lighter and smaller. The capacitor(s) on the output(s) of an SMPS may be quite small due to the high switching frequency, but the choice of the right capacitor(s) also depends on other factors such as the required energy storage capacity and the AC ripple induced by the load (e.g. motors). The size of the major components generally decreases with increasing operating frequency. However, efficiency drops appreciably above approx. 250 kHz as the losses in all components rise sharply.

### Mixed architectures

Different combinations of the above basic designs are in use. For example, the R&S®NGE100B power supplies use a mains transformer at the input, followed by a rectifier and switched-mode circuitry to regulate the output voltage, providing high efficiency. A linear stage reduces unwanted signal components at the output.

Basic types of power supplies			
Power supply	Linear	Mixed	Switched mode
R&S®HMC804x			•
R&S®NGE100B		•	
R&S®NGA100	•		
R&S®HMP2000/4000		•	
R&S®NGP800			•
R&S®NGL200	•		
R&S®NGM200	•		
R&S®NGU201/401	•		

### One, two or four quadrants – source and sink operation

A standard power supply typically acts as a source of power, meaning that current flows out of the positive voltage terminal. This type of power supply is also called unipolar as it delivers voltage with a single polarity (see first quadrant in the next figure).

## Quadrants of DC power supplies

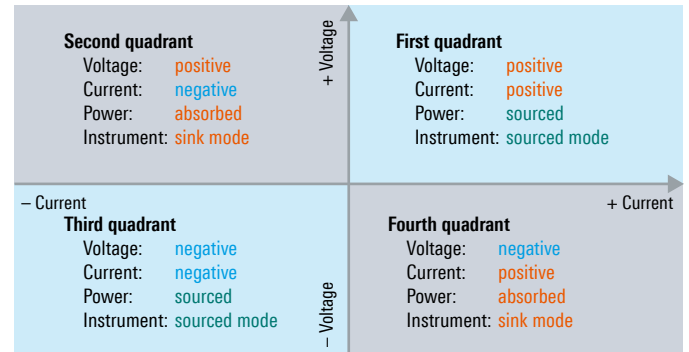

If current flows into the positive voltage terminal, the power supply acts as an electronic load. It is sinking power instead of sourcing power. Instruments that function both as a source and sink can simulate batteries or loads; they are called two-quadrant (or four-quadrant) power supplies.

Rohde&Schwarz specialty power supplies offer two- and four-quadrant architecture. The instruments automatically switch from source to sink mode. When the externally applied voltage exceeds the set nominal voltage, current flows into the power supply, which is indicated by a negative current reading.

The architecture of power supplies can be fully defined using a Cartesian coordinate system. The four quadrants show all combinations of positive and negative voltage and current. The figure below illustrates a coordinate system with voltage on the vertical and current on the horizontal axis.

As mentioned above, standard power supplies typically generate voltage of positive polarity only (i.e. they work in the first quadrant), for example from 0 V to 20 V. If a power supply can provide either positive or negative voltage at its output terminals without having to switch the external wiring, it is referred to as a bipolar power supply and will work in quadrants 1 and 3, providing voltages from -20 V to +20 V, for example. Such instruments can be used, among other things, to test the characteristic behavior of semiconductors for bipolar voltages across the 0 V point.

Power supplies that can operate in quadrants 1 and 3 typically also offer sink functionality for positive and negative voltages and currents. They can operate in all four quadrants and are referred to as source measure units (SMUs). In the first and third quadrant, current flows out of the voltage terminal; the instrument is sourcing power. In the second and fourth quadrant, current flows into the voltage terminal; the instrument is sinking power.

One, two or four quadrants			
Power supply	One quadrant	Two quadrants	Four quadrants
R&S®HMC804x	•		
R&S®NGE100B	•		
R&S®NGA100	•		
R&S®HMP2000/4000	•		
R&S®NGP800	•		
R&S®NGL200		•	
R&S®NGM200		•	
R&S®NGU201		•	
R&S®NGU401			•

### Channels with identical voltage ranges

Most of the Rohde & Schwarz power supplies offer the same voltage range on all channels. This means it does not matter which channel you choose for a specific application. Each channel can be regarded as a separate power supply.

### Ripple and noise

Advanced, complex electronic circuitry is very sensitive to voltage variations on the supply lines. To minimize interference when powering devices under test (DUTs), power supplies must provide extremely stable output voltages and currents. Ideally, an output is free from voltage variations. In practice, there are two types of variation that can possibly affect the circuit or device: periodic variations (ripple) and random variations (noise), also referred to as periodic and random deviations (PaRD). Linear power supplies exhibit significantly lower high-frequency ripple compared to switched-mode power supplies.

Specialty power supplies as well as some basic power supplies such as the R&S®NGA100 employ linear voltage regulation for minimal residual ripple and noise.

### Ripple and noise

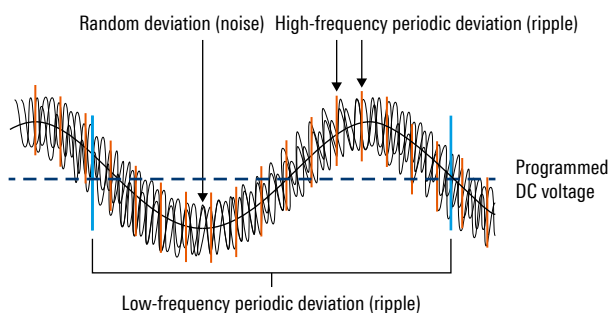

The linear design of the output stages makes it possible to supply low-interference voltage to sensitive designs such as complex semiconductors. Low ripple and noise values are also perfect for developing power amplifiers and MMICs.

Ripple and noise (20 Hz to 20 MHz)		
Power supply	Voltage (RMS)	Current (RMS)
R&S®HMC8041	< 1 mV	< 1.5 mA
R&S®HMC8042/43	< 450 µV	< 1 mA
R&S®NGE100B	< 1.5 mV	< 2 mA
R&S®NGA101/102	< 0.5 mV	< 500 µA
R&S®NGA141/142	< 1.5 mV	< 500 µA
R&S®HMP2000/4000	< 1.5 mV	< 1 mA
R&S®NGP800	< 3 mV	< 3.5 mA
R&S®NGL200	< 500 µV	< 1 mA
R&S®NGM200	< 500 µV	< 1 mA
R&S®NGU201/401	< 500 µV	< 1 mA

### Variable output impedance

The outputs of specialty power supplies can be configured in various ways. For example, parameters such as the output impedance, a switch-on delay and different trigger modes can be set. Power supplies should have an output impedance as low as possible to avoid loading effects on the DUT. However, there are applications that require simulating batteries in a controlled manner, or simulating the increase in internal impedance as the battery discharges. The R&S®NGL200, R&S®NGM200 and R&S®NGU201 power supplies support these applications with adjustable output impedance.

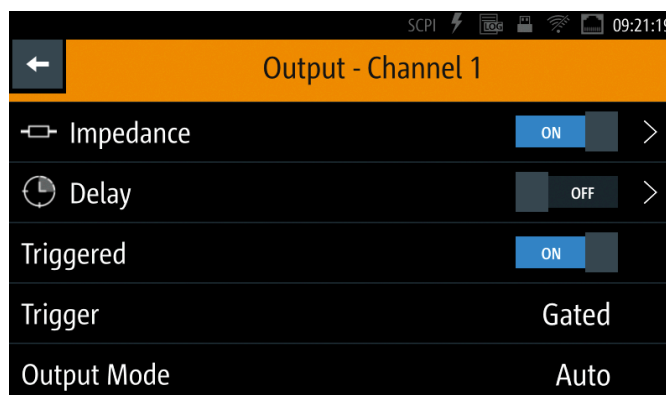

Output menu of the R&S®NGM200 power supply.

## OUTPUT RESPONSE

It is important to choose a power supply that can follow quickly changing load conditions. If, for example, a device switches from very low to high current consumption, the power supply will take some time before its output reaches its final setting. On the other hand, power supplies can react with overshoots that endanger sensitive DUTs.

Depending on the type of power supply, it will respond to abrupt load changes with slower or faster recovery times.

## Load recovery time

Load recovery time, also referred to as transient response, describes the time required by a DC power supply to reach a set voltage level after a load change. The power supply's output voltage drops when the current suddenly rises. Likewise, a decrease in current causes a momentary increase in the power supply's voltage. Load recovery time is the duration after which a power supply has recovered from such transient caused by a significant load change.

Consumer electronics such as mobile phones and IoT devices require very little power in sleep mode. However, the current increases abruptly when the device switches to transmit mode. A power supply used to power such DUTs must be capable of handling load changes from a few nA to the ampere range with minimum voltage drops and overshoots.

## Optimized load recovery time

Voltage regulation of DC power supplies under load transients.

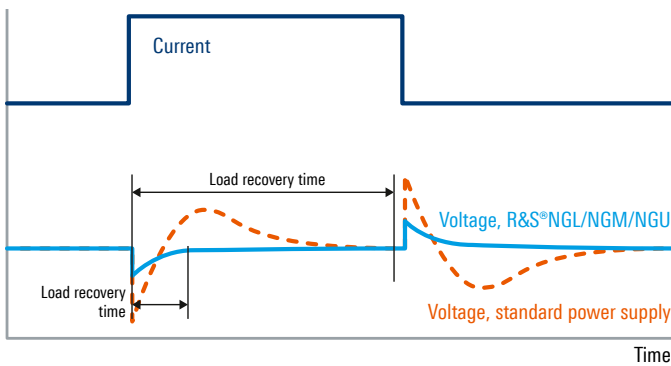

Specialty power supplies have optimized control circuits that react very fast to load changes and minimize overshoots.

The R&S<sup>®</sup>NGL/NGM series power supplies and the R&S<sup>®</sup>NGU source measure units allow users to choose how the instrument should respond to load changes.

The "Fast" default setting is optimized for speed, achieving recovery times of < 30  $\mu$ s. Deactivating "Fast" will slightly increase recovery time, focusing on preventing overshoots under special load conditions.

Load recovery time (10% to 90% load change)	
R&S <sup>®</sup> HMC804x	< 1 ms
R&S <sup>®</sup> NGE100B	< 200 $\mu$ s
R&S <sup>®</sup> NGA101/102	< 100 $\mu$ s
R&S <sup>®</sup> NGA141/142	< 50 $\mu$ s
R&S <sup>®</sup> HMP2000/4000	< 1 ms
R&S <sup>®</sup> NGP800	< 400 $\mu$ s
R&S <sup>®</sup> NGL200	< 30 $\mu$ s
R&S <sup>®</sup> NGM200	< 30 $\mu$ s
R&S <sup>®</sup> NGU201/401	< 30 $\mu$ s

## Voltage priority and current priority mode

Setting and regulating the output voltage (constant voltage mode) is the standard mode for power supplies.

Most power supplies can also be used in constant current mode, where current limiting ensures that only the configured current can flow. However, these devices are not optimized for fast current limiting. There is a risk of damage to sensitive DUTs due to excessive currents from overshoots in current regulation. To avoid this risk, the R&S<sup>®</sup>NGU source measure units have separate operating modes for voltage and current regulation.

## Voltage priority mode

The standard mode of power supplies provides fast voltage regulation with the risk of overshoots in current.

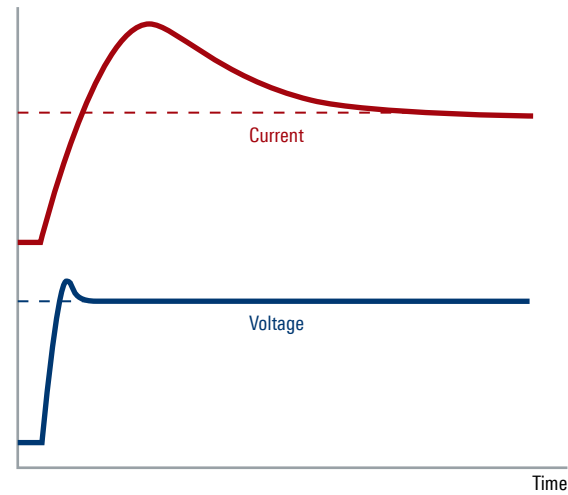

## Current priority mode

A special mode for current sensitive DUTs provides fast current regulation. It is the right choice when you have to avoid excessively high currents to protect your DUT.

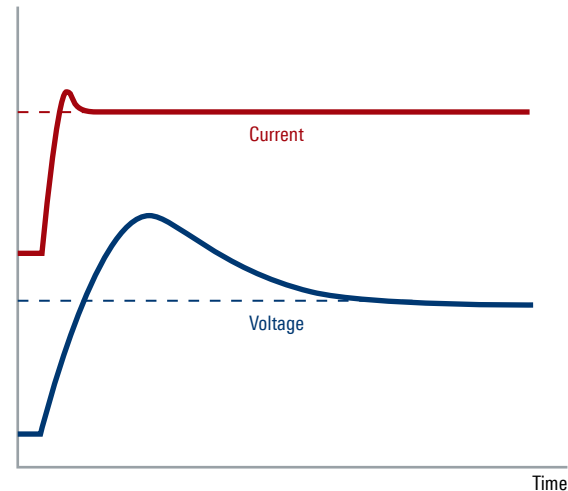

In voltage priority mode, fast voltage regulation provides short recovery times of  $< 30 \mu\text{s}$ . Current regulation is designed to be somewhat slower to avoid the tendency to oscillate.

When precise and quick current regulation is desired, the R&S®NGU source measure units can be operated in current priority mode with a load recovery time of  $< 50 \mu\text{s}$ . Optimized for fast current regulation, this mode allows testing DUTs such as LEDs, which are sensitive to even short current spikes.

### Constant voltage, constant current, constant resistance

Depending on the application, it is important to keep either the voltage, current or resistance fixed. This is achieved in the CV, CC and CR modes.

In constant voltage (CV) mode, the output voltage is kept constant at the set level, e.g. 5 V, while the current varies as a function of the DUT's behavior and within the set current limits. All Rohde&Schwarz power supplies can also be operated in constant current mode (CC), where each channel can be separately configured. In this mode, a constant preset current flows to the DUT, and the voltage varies, i.e. the output voltage is reduced or increased to keep the current at the set value. When the power supply operates as an electronic load, constant resistance mode (CR) is also available. In this mode, the power supply behaves like a constant, user-settable resistance over the entire load range. This makes it possible to simulate battery discharge behavior with a constant load resistance.

If the DUT load current is low and the current drawn is lower than the set current limit, the power supply will by default operate in CV mode. The voltage is regulated to a constant value, and the current varies as a function of the load. If the load current is high and the load attempts to draw current above the set current limit, the power supply will by default limit the current to the set value and operate in CC mode. The current is regulated and the voltage is determined by the load.

### Constant voltage, constant current, constant resistance

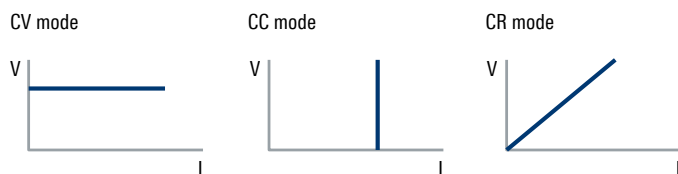

## OUTPUT POWER

### Autoranging: FlexPower

Elementary power supplies often operate in a single range only. Single-range power supplies deliver maximum power  $P_{\text{max}}$  only at the maximum rated voltage  $V_{\text{max}}$  and current  $I_{\text{max}}$ . The left chart in the figure below shows the output characteristics of a single-range power supply.

Multi-range power supplies have wider output voltage and current ranges. The middle chart shows a dual-range power supply.

These power supplies generate a much higher  $V_{\text{max}}$  or  $I_{\text{max}}$  within the same maximum power limit as a single-range power supply. Both voltage and current outputs have two operating ranges within the same  $P_{\text{max}}$  power envelope.

Autorange power supplies have an infinite number of ranges. Rohde&Schwarz autorange power supplies use the FlexPower technology (see right chart in the figure on next page).

The Rohde&Schwarz FlexPower feature makes it possible to test a wide range of product families with a single power supply. This substantially extends flexibility, saves space and simplifies the test setup.

FlexPower power supplies are also great when you need high voltage and current, but not a high output power. Using a single-range power supply to meet this need is much more expensive than using a FlexPower power supply.

FlexPower	Maximum output power	FlexPower
R&S®HMC804x	100 W	•
R&S®NGE100B	100 W	•
R&S®NGA100	80 W	•
R&S®HMP2000/4000	384 W	•
R&S®NGP800	800 W	•
R&S®NGL200	120 W	
R&S®NGM200	120 W	
R&S®NGU201/401	60 W	

## Parallel and serial operation

If your application requires more voltage or current than your power supply can provide, simply connect the outputs in series or parallel.

In serial mode, channels can be combined for higher output voltages. Each output needs to be set to the maximum current limit the load can safely handle. Then equally distribute the total desired voltage to each power supply output.

### Serial and parallel connection of DC power supply outputs

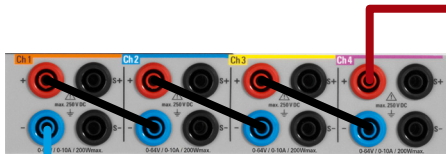

Serial operation – max. 250 V

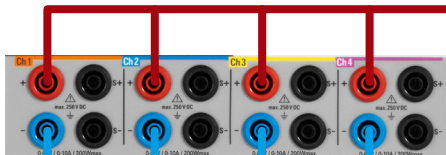

Parallel operation – max. 80 A

For higher currents, channels can be wired in parallel. Current limiting needs to be equally distributed among the power supply outputs to reach the required total limit.

Using the tracking function, voltage and current are adjusted simultaneously on all selected channels.

For parallel operation in constant voltage mode and serial operation in constant current mode, certain rules have to be observed when configuring the channels in order to reasonably distribute power, voltage and current among the channels.

The R&S®NGA102 and R&S®NGA142 power supplies support channel fusion. With serial or parallel channel fusion, the device acts like a single-channel power supply offering double the voltage or current range. In serial mode, the outputs are connected internally, while parallel mode requires external wiring.

### Serial and parallel operation

	Maximum voltage in serial operation	Maximum current in parallel operation
R&S®HMC804x	96 V	10 A
R&S®NGE100B	96 V	9 A
R&S®NGA100	200 V	12 A
R&S®HMP2000/4000	128 V	40 A
R&S®NGP800	250 V	80 A
R&S®NGL200	40 V	12 A
R&S®NGM200	40 V	12 A

## Maximum power of a DC power supply in a voltage versus current representation

### Single-range



### Dual-range

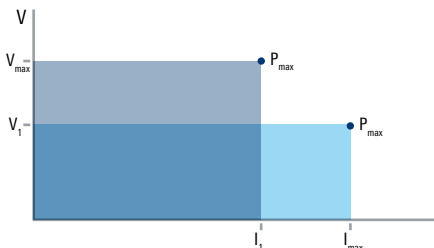

### FlexPower

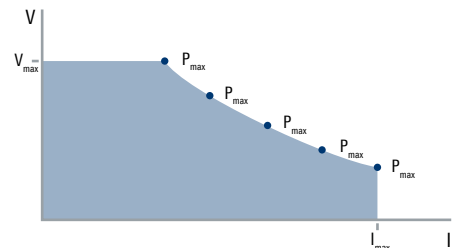

# MEASUREMENT AND MONITORING



## REMOTE SENSING

Significant voltage drops can occur on the supply leads from a power supply to a DUT, especially with longer connection leads or in applications with high current consumption, so that the programmed voltage is not attained at the DUT input. Power supplies offering remote sensing, also known as four-wire sensing, are able to compensate for these voltage drops. To achieve this, the voltage actually present at the DUT is measured using a pair of sense lines in addition to the force lines. The measured value is used to regulate the power supply's output voltage so that the desired voltage is present at the DUT input. Depending on the model, the Rohde & Schwarz power supplies provide remote sensing for each output channel.

### Functional diagram of sense lines on a DC power supply

Four-wire remote sensing compensates for voltage drops on the load leads.

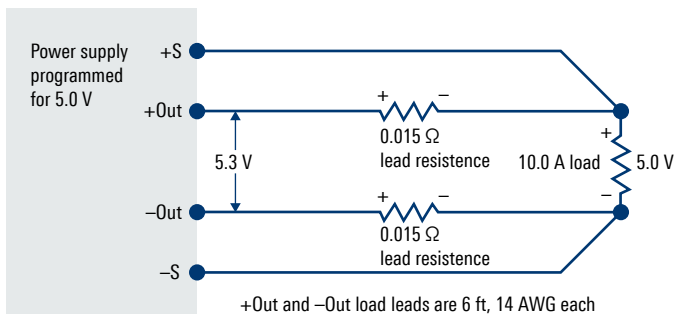

Backplane of an R&S®HMP400 with force and sense connections.

Remote sensing	Front	Rear
R&S®HMC8041	•	•
R&S®HMC8042/8043		•
R&S®NGE100B		
R&S®NGA100		•
R&S®HMP2000/4000	•	•
R&S®NGP800	•	•
R&S®NGL201	•	•
R&S®NGL202		•
R&S®NGM201	•	•
R&S®NGM202		•
R&S®NGU201/401	•	•



# BUILT-IN MEASUREMENTS

Rohde&Schwarz power supplies come with a range of built-in measurements that can in many applications replace additional instruments such as an external oscilloscope or a multimeter to measure e.g. instantaneous power. Since no extra load is connected to the power supply, no additional burden voltage needs to be taken into account – a major advantage offered by built-in measurements. In addition, they are very convenient and simplify the setup.

Advanced power supplies provide further analysis functions such as statistics, including min./max. and average values for power, voltage and current as well as an energy count.

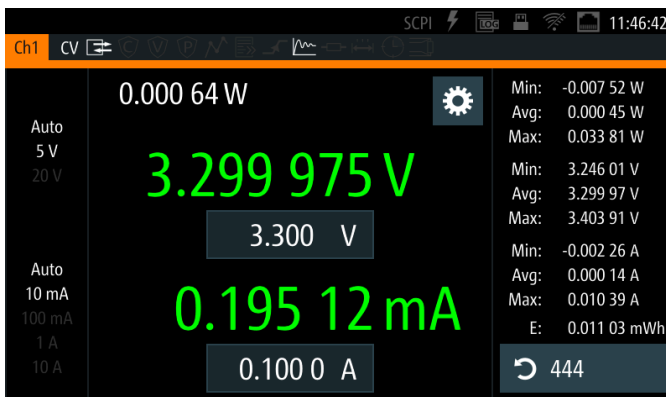

Integrated statistics show the min./max. and average values for power, voltage and current as well as an energy count.

High-precision power supplies such as the R&S<sup>®</sup>NGL200, R&S<sup>®</sup>NGM200 and R&S<sup>®</sup>NGU offer measurements with 6½ digit resolution. If in addition a power supply features a high-speed ADC, like with the R&S<sup>®</sup>NGM200 and R&S<sup>®</sup>NGU, even fast transients can be detected and measured.

Measured values can be recorded versus time using the logging functions (for details, see Logging on page 12). Some power supplies with a large display also offer graphical analysis functions (for details, see Graphical View on page 10).

# DIGITAL VOLTMETER FUNCTIONALITY

Some power supplies can be equipped with an optional integrated digital voltmeter (DVM), which even further expands the instruments' built-in measurement capabilities. The DVM allows measuring the voltage at any desired point in the DUT circuitry. This renders an additional multimeter superfluous.

The DVM option is available for all R&S<sup>®</sup>NGM200 models and the R&S<sup>®</sup>NGU201.



DVM display on an R&S<sup>®</sup>NGM200 power supply.

## Built-in digital voltmeter

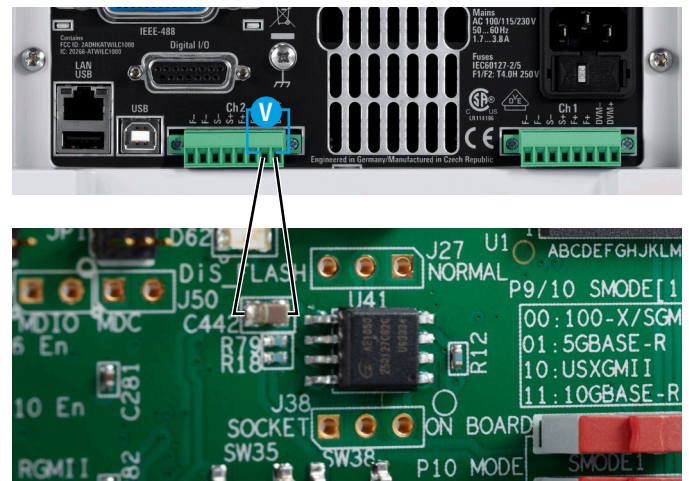

Measures the voltage at any point in the DUT circuitry.

# GRAPHICAL VIEW

Analyzing and visualizing measurements in real time often requires an additional oscilloscope. There are only a few advanced power supplies with a high-resolution display that can offer basic oscilloscope functionality, exploiting their internal logging functionality in combination with their measurement capabilities. This feature is also available on some Rohde&Schwarz power supplies, where it is referred to as Graphical View. It enables quick and convenient analysis, especially of ongoing processes like the charging and discharging of batteries and the transitions between different operating states of a DUT. The integration of all measurements in one box reduces test setup complexity and ensures, by design, the integrity and correlation of all measurements.

Up to four traces can be displayed simultaneously in a single window on the instrument's front panel. Specific traces can be selected to display voltage, current and power for the individual channels, and the traces can be set to display the minimum and maximum values.

The values obtained for the selected quantities and channels are plotted versus time on the x-axis. The time base is always 5 s/div with a period of 60 s visible in roll mode.

The instrument automatically selects the optimal scaling for the data to be displayed.

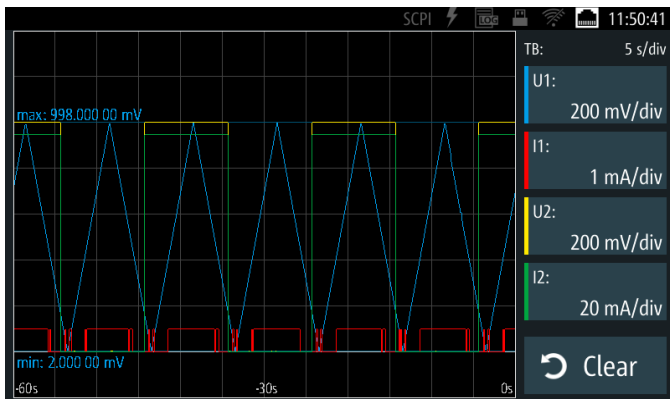

Graphical View on an R&S®NGP800.

	Graphical View available
R&S®HMC804x	–
R&S®NGE100B	–
R&S®NGA100	–
R&S®HMP2000/4000	–
R&S®NGP800	•
R&S®NGL200	•
R&S®NGM200	•
R&S®NGU201/401	•

# ACCURACY AND RESOLUTION

Accuracy and resolution are often used synonymously, but they are two different things. Resolution is the smallest possible increment a measuring instrument is able to capture and display for a given measured quantity. Accuracy indicates how far a measured result deviates from the correct value. High resolution does not necessarily mean high accuracy and vice versa. Some measurements require high resolution and low accuracy, for example when making relative measurements. High accuracy is required when absolute measurement values are of interest.

In the example on the right, the measured current is 5 A. The ammeter has an accuracy of  $\pm 0.4$  A, meaning that the measured value can be up to 0.4 A above or below the correct value.

The lower ammeter has a tighter scaling for the readings, which means a higher resolution. Higher resolution reduces rounding errors, but has no influence on a device's accuracy.

## Accuracy versus resolution

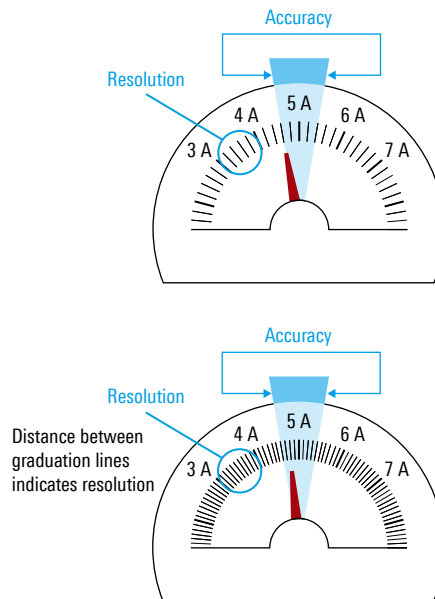

## Resolution

In general terms, resolution is the smallest discernable increment of a physical quantity. In mixed analog/digital systems, it mainly depends on the digital resolution, e.g. the number of digits in numerical representation.

There are two types of resolution in power supplies:

- ▶ Programming resolution: defines the granularity with which unloaded voltage and current limits can be set
- ▶ Readback resolution: defines the granularity with which the actual voltage and current can be measured

Programming resolution is the smallest selectable increment when setting voltage or current on a power supply. The resolution specification also indicates the number of discrete levels that can be set. The power supply's control loop regulates the voltage so that the programmed value is achieved at the output. The specified resolution represents one single step on a DAC. For example, the voltage programming resolution of the R&S®NGM200 series is 1 mV. This means that the value at the output can be changed in 1 mV steps. Power supplies of the R&S®NGM200 series, therefore, can be set to 0.999 V, 1 V, 1.001 V, etc.

The Rohde&Schwarz power supplies differ in their programming and readback resolutions. The table below shows the programming and readback resolution for voltage and current in the most sensitive range.

	Programming resolution	Readback resolution
R&S®HMC8041	1 mV/0.5 mA	1 mV/0.5 mA
R&S®HMC8042/43	1 mV/0.1 mA	1 mV/0.1 mA
R&S®NGE100B	10 mV/1 mA	10 mV/1 mA
R&S®NGA100	1 mV/1 mA	1 mV/1 µA
R&S®HMP2000	1 mV/0.1 mA	1 mV/0.1 mA
R&S®HMP4000	1 mV/0.2 mA	1 mV/0.2 mA
R&S®NGP800	1 mV/0.5 mA	1 mV/0.5 mA
R&S®NGL200	1 mV/0.1 mA	10 µV/10 µA
R&S®NGM200	1 mV/0.1 mA	5 µV/10 nA
R&S®NGU201/401	50 µV/100 nA	1 µV/100 pA

## Accuracy

Generally speaking, accuracy defines how close any value is to the correct value. Measurement accuracy defines how far a measured result deviates from the correct value.

There are two types of accuracies for power supplies:

- ▶ Programming accuracy: refers to how close the voltage or current output is to the set or programmed value
- ▶ Readback accuracy: refers to how accurately a power supply can measure the actual output voltage or current

The processes of output value programming and readback measurement are implemented by two different systems – with a D/A converter and an A/D converter, respectively. The programming accuracy is determined by the accuracy of the D/A converter and the readback accuracy by the accuracy of the A/D converter. The converters will usually have different accuracies and resolutions.

The programming accuracy of a power supply is a measure of how close the actual output will be to the programmed value. The voltage programming accuracy of the R&S®NGM200 series is  $\pm < 0.02\% + 3 \text{ mV}$ . If the output voltage is set to 20 V, the actual output voltage can be up to 7 mV ( $20 \times 0.02\% + 3 \text{ mV} = 7 \text{ mV}$ ) above or below the set voltage, i.e. the actual output voltage will be between 19.993 V and 20.007 V.

$$V_{out} \times \text{Quantization error in \%} + \text{offset in V} = \Delta V_{out}$$

The accuracy specification for power supplies includes an error term for the quantization error. It also includes many other factors such as DAC accuracy, DAC linearity, gain errors of the feedback loops, and temperature drift of components.

The Rohde&Schwarz power supplies differ in their programming and readback accuracies. The diagrams below show the readback accuracies for the individual instruments.

## Voltage readback accuracy in optimal measurement range

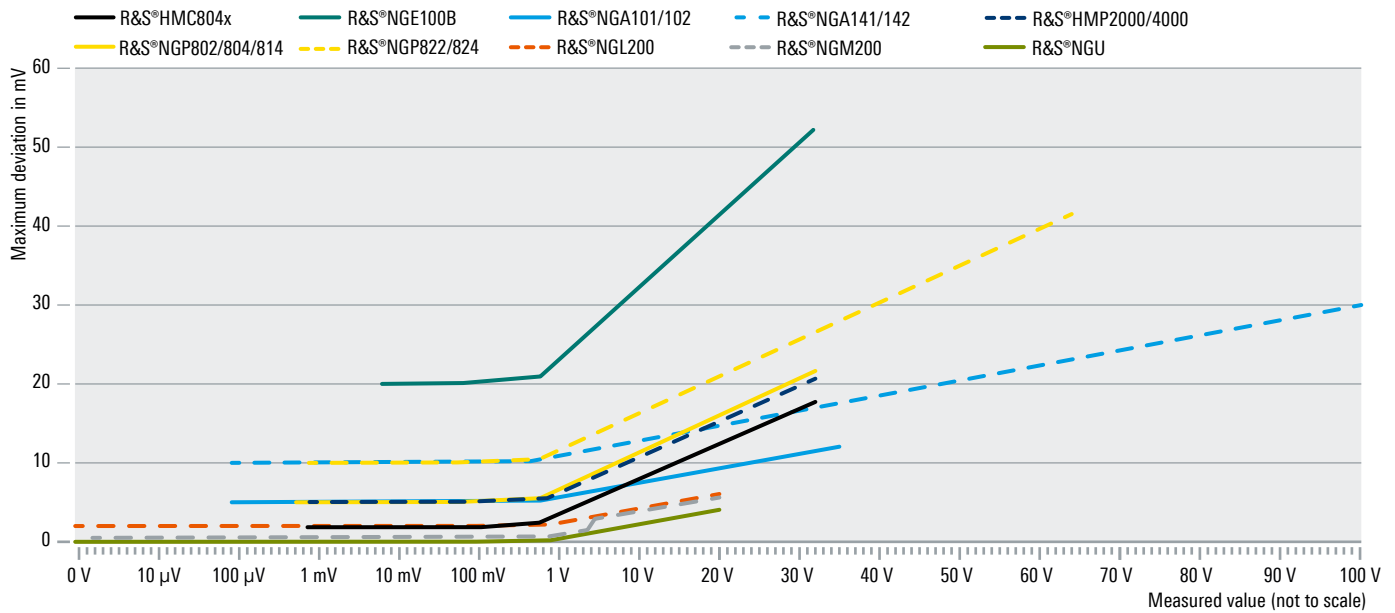

## Current readback accuracy in optimal measurement range

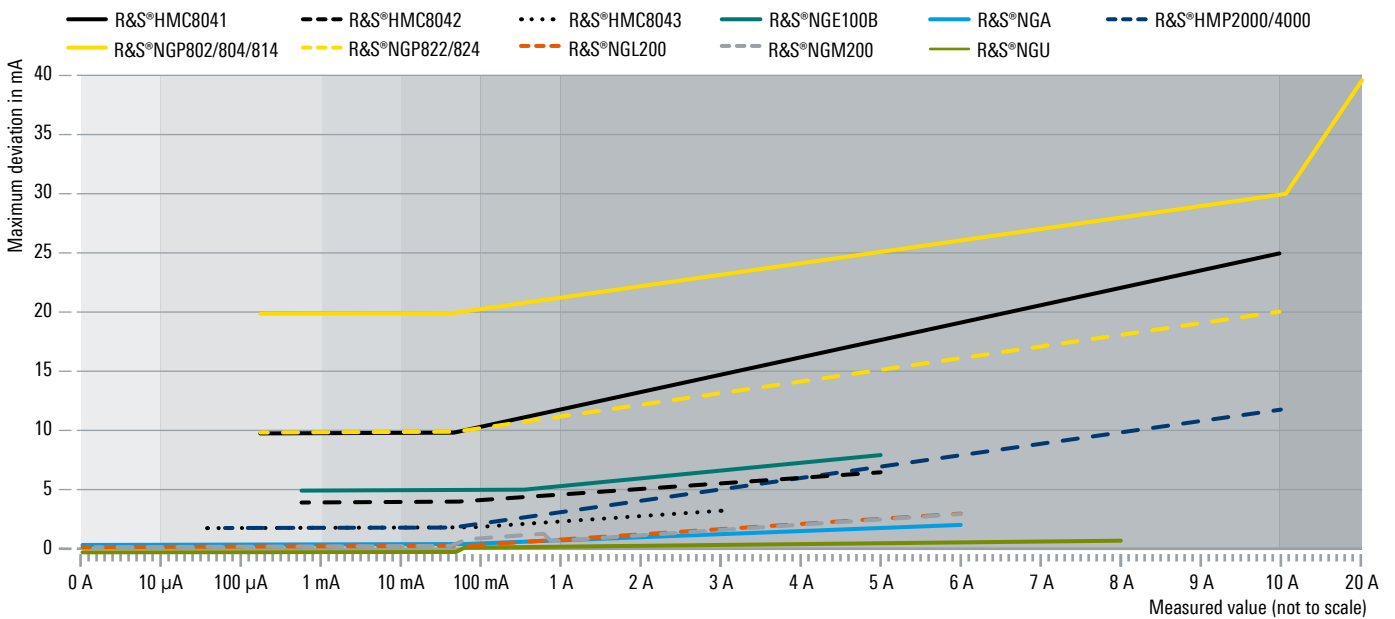

## LOGGING

While measurement results provide a fast overview of the actual voltage, current and power measured on the DUT, it is in many applications desirable to monitor and view variations of these values, i.e. the DUT behavior, over long periods of time, or with high time resolution, or both.

### Standard logging and fast logging

Most Rohde & Schwarz power supplies offer standard logging functionality, and some even feature fast logging functionality, with sample rates as shown in the table on the right.

Standard logging collects measurement data from all active channels of a power supply simultaneously and stores it to one common file. The settings for standard logging are therefore found in the power supply's Device menu.

The R&S®NGM200 and R&S®NGU power supplies additionally offer fast logging.

Fast logging (FastLog) with a sample rate up to 500 ksample/s allows capturing voltage and current values versus time in an oscilloscope-like manner. It can help analyze energy consumption of different functional blocks of a DUT and detect faults in the DUT's circuitry.

Fast logging collects measurement data from individual channels of a power supply and stores it to separate files. The settings for fast logging are therefore found in the Channel settings menus.

By logging the values of the current flowing through analog sensors like photo cells and thermistors, environmental data like illuminance and temperature can be determined.

	Standard logging	Fast logging
R&S®HMC804x	● 1000 sample/s	–
R&S®NGE100B	–	–
R&S®NGA100	● 10 sample/s	–
R&S®HMP2000/4000	–	–
R&S®NGP800	● 125 sample/s	–
R&S®NGL200	● 10 sample/s	–
R&S®NGM200	● 10 sample/s	● 500 ksample/s
R&S®NGU201/401	● 10 sample/s	● 500 ksample/s

### Data collection and data storage

For the user's convenience, logged data is written to ASCII files with character-separated values (\*.csv). These files can be opened in an editor or in a spreadsheet.

Due to the large amount of data expected with fast logging, the power supply delivers this data in IEEE floating point format. The data can be stored to an external USB memory device or provided to a remote control host over an Ethernet or USB connection. Fast logs stored on an external memory device can be converted to \*.csv format at a later date.

### Starting standard/fast logging

Standard or fast logging can be started manually, by remote control, by activating a power supply channel, or by an external event signalled at the digital trigger input. The trigger function allows the power consumption of connected loads to be captured even in the case of arbitrarily occurring events. It is also possible to synchronize the start of the logging with actions taking place on other measuring equipment.

### Data visualization

Since ASCII files in \*.csv format can be opened in a spreadsheet, it is easy to quickly create diagrams of the captured data, e.g. using a scatter graph template.

An even more convenient alternative is using an application program like the 1GP122 logging tool from Rohde & Schwarz. It can be downloaded free of charge from the Rohde & Schwarz website.

### FastLog high-speed acquisition

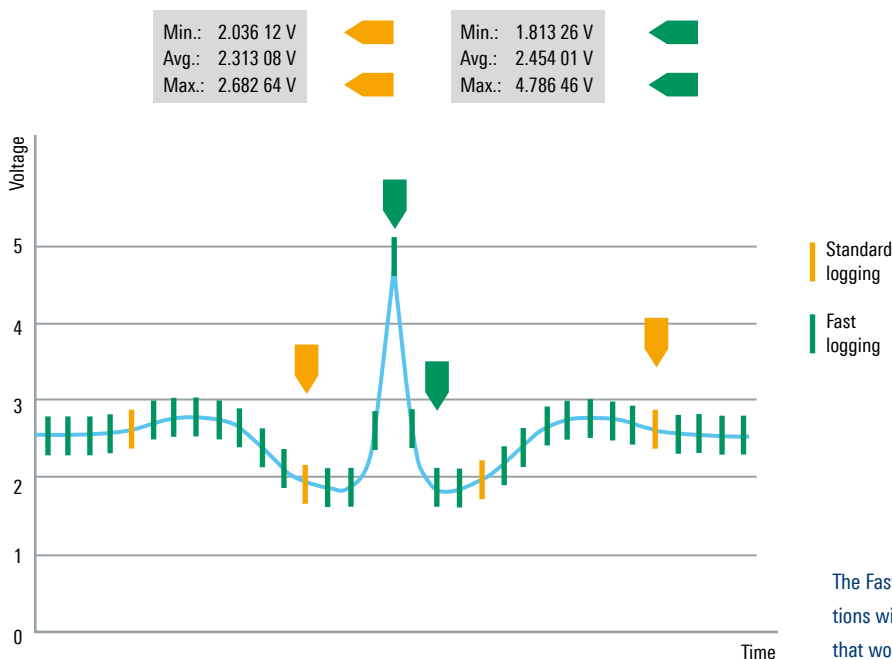

The FastLog functionality follows voltage/current variations with a resolution of up to 2  $\mu$ s. It detects spikes that would go unnoticed with slower instruments.

# INTERFACES, SAFETY AND ARBITRARY FUNCTIONS



## CONTROL INTERFACES

The growth in productivity has led to a dramatic improvement in the quality of our lives over the last few decades. Being able to produce more with fewer resources in a shorter amount of time makes our labor more valuable and the product of our labor cheaper. One of the factors contributing to the growth in productivity is automation.

Automation in the test and measurement industry has become widely used. Nowadays practically every modern measurement instrument can be controlled remotely. Rohde & Schwarz invests significant resources to provide its instruments with a wide variety of high-performance connectivity options.

### Full connectivity

Rohde & Schwarz power supplies offer a variety of interfaces to remotely control the instruments and to connect external devices to meet the requirements of varying test environments. Power supplies can be configured with appropriate hardware interfaces like GPIB, USB and LAN for remote control while the digital I/O interface can be used to set up trigger systems. Some power supplies can be equipped with an analog input for amplifying the power of the input signal or tracking an analog input voltage.

Depending on the power supply model, different types of interfaces are available (see table below).

### Main advantages of automating measurement tasks

Advantage	Explanation
Automation saves time.	Investing time into developing a remote-control application pays off:  Repeating a measurement task many times over takes significantly less time.  Automation saves you a lot of routine work and lets you focus on the creative aspects of your project.
Instruments can be operated from a distance.	This facilitates, for example, testing a device under test (DUT) in a climatic chamber or an anechoic RF chamber.
Measurements are repeatable.	Measurement tasks are always performed according to a defined procedure. Once correctly debugged, they always deliver repeatable results. This helps to increase measurement confidence.
Automated systems are easier to expand.	With an appropriate test configuration, you can perform the same measurement on several DUTs. For example, a four-channel power supply can be used to test four DUTs. If you need to connect more DUTs, you can use an automated switching unit.
Test result documentation is provided as a standard functionality.	Many programming environments offer ready-to-use toolboxes for documenting and processing test results.

## Remote control interfaces and protocols

Diverse remote control interfaces are available. Communication over these interfaces takes place using the SCPI command set and syntax. A USB interface is provided as standard; the LAN interface comes standard or optional. An IEEE-488 (GPIB) interface is optionally available on some instruments and can be retrofitted at a later date. All power supply parameters as well as available measurements can be remotely controlled via these interfaces.

The USB virtual COM port (VCP) lets the interface be addressed like a legacy RS-232 port. The USB communications device class (CDC) can be used to transmit Ethernet frames via USB. The USB test and measurement class (TMC) allows higher data rates, which is particularly useful when transferring files and data generated with the FastLog function provided on some of the power supplies.

For the LAN interface (Ethernet), an IP network address can be set manually (fixed address), or a dynamic IP address can be allocated via DHCP. Some instruments can be controlled via a web interface from a browser.

## Instrument drivers

Measurement instruments can be remotely controlled without the use of instrument drivers, using SCPI commands instead.

Nevertheless, for most of the Rohde & Schwarz power supplies, a comprehensive selection of drivers is available for download from our web page. Drivers make it possible to integrate remote control functionality with software tools like LabVIEW and programming languages like C, C++, Python and .NET languages in a much more efficient and reliable manner. Drivers provide procedures to encapsulate remote control functionality for certain tasks like setting parameters, starting measurements and querying results.

## Interfaces on Rohde & Schwarz DC power supplies

Interfaces	Power supplies (R&S®)									
	NGE100B	HMC804x	NGA100	HMP2000	HMP4000	NGP800	NGL200	NGM200	NGU201/401	
USB	•	•	•	○	○	•	•	•	•	
USB TMC	•	•	•			•	•	•	•	
USB VCP				○	○					
USB CDC	•	•	•			•	•	•	•	
LAN	○	•	•	○	○	•	•	•	•	
GPIB		○		○	○	○	○	○	○	
RS-232				○	○					
Digital trigger I/O	○	•	○			○	○	○	○	
Analog input						○				
Modulation input									•	

• Included      ○ Optional

## Rear view of an R&S®NGP800 power supply with interface ports

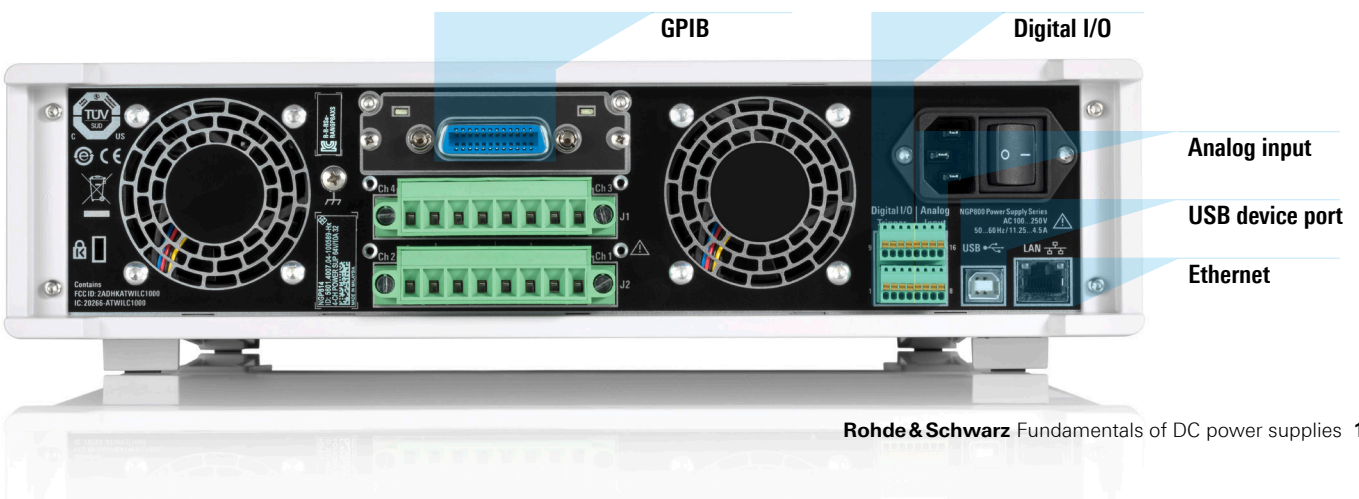

The autocomplete function of integrated development environments (IDE) like Microsoft Visual Studio® shows available procedures and function calls together with the associated parameters and their variables, which considerably speeds up the coding process.

Virtual instrument software architecture (VISA) is required as an intermediate software layer between the instrument drivers and the drivers for the physical remote control interfaces. VISA is an application programming interface (API) that allows writing remote control code independent of the remote control interface. The instrument to be controlled and the interface for the connection are selected during runtime. In addition, VISA provides utilities like a search on the interfaces for connected instruments. VISA can be downloaded from the Rohde&Schwarz web page.

### Digital trigger I/O

Digital trigger I/O interfaces are available for a number of power supplies (see table on page 15). They can be individually used as trigger inputs or outputs. For easier access, the R&S®NGP800, R&S®NGL200, R&S®NGM200, R&S®NGU201 and R&S®NGU401 power supplies come with pluggable 8-pin terminal blocks for the rear output connections and analog input connections, and with a 5-pin, 8-pin or 15-pin connector for the digital trigger I/O.

The R&S®NGx-K103 option allows setting up a trigger system to generate trigger events for output control or event/status/mode indication. As an input, the trigger I/O can enable or inhibit outputs or start functions such as QuickArb or logging. As an output, the trigger I/O can indicate protection triggers in response to an overload condition, as well as voltage/current/power level events and actual output operating modes. In addition, the digital trigger system allows you to control output delays or fuse linking across multiple channels or instruments.

### Remote control via VNC

The R&S®NGP800, R&S®NGU, R&S®NGL200 and R&S®NGM200 power supplies offer the possibility of being controlled via virtual network computing (VNC). With this technology, not only the power supply's graphical user interface is displayed on a remote device (e.g. a PC or mobile device), but also all controls such as buttons and rotary knobs otherwise available for direct control. The power supply can thus be operated from a remote device without having physical access to it. To establish a VNC connection, the power supply must be available in the same network and accessible via LAN. After VNC has been activated on the power supply, it can be remotely accessed via its IP address. There are two ways to access the instrument. Either, a VNC client on the remote device can be used. Or, a web server based VNC client enables real-time user interaction with the power supply without the necessity of installing a VNC client. The latter application can be accessed by entering the power supply's IP address in the URL bar of the browser.



Remote control of an R&S®NGP800 power supply via VNC.

## ANALOG INTERFACES

### Analog input

The R&S®NGP-K107 analog input option for the R&S®NGP800 power supplies makes it possible to control output voltages and currents directly and much faster. An external control voltage from 0 V to 5 V can control any or all of the outputs with an input scaling from 0% to 100%. Galvanic isolation between the control voltage and the outputs greatly simplifies the connection while maintaining

### Drivers for Rohde & Schwarz DC power supplies

Drivers	Power supplies (R&S®)								
	NGE100B	HMC804x	NGA100	HMP2000	HMP4000	NGP800	NGL200	NGM200	NGU201/401
IVI driver	•	•	•	•	•	•	•	•	•
VXI plug & play driver	•	•	•	•	•	•	•	•	•
LabVIEW driver	•	•	•	•	•	•	•	•	•
LabWindows/CVI, Linux/Mac OS X driver	•	•	•	•	•	•	•	•	•
USB VCP driver				•	•				
USB CDC driver	•	•	•						



user safety even for high-voltage and floating-circuit applications. The analog input can be used, for example, to quickly and simultaneously change the output voltage on a number of power supplies connected in series or in parallel.

The analog input can be deployed to make the output voltage slowly follow an analog input voltage. With an update rate of 1 kHz, however, this process is not fast enough to be used for modulation.

### Modulation input

The modulation input on the R&S®NGU401 source measure unit allows an AC signal with up to 1 kHz bandwidth to be modulated on the set DC voltage. A possible application is measuring the power supply rejection ratio on amplifiers.

### Properties of the R&S®NGU401 modulation input

Property	R&S®NGU401
Modulation bandwidth	DC to 1 kHz
Input level	-24 V to + 24 V
Accuracy (displayed modulation value)	< 0.02% + 2 mV

## SAFETY

### Protection functions to safeguard the instrument and DUT

Power supplies with DUT protection are recommended if there is a risk of damage to the DUT (load) caused by over-voltage or overcurrent. On many power supplies, there is a limit defining the maximum settable voltage and current. When such a limit has been set, the power supply will not exceed the specified voltage and/or current regardless of the load.

Since even the most experienced user is occasionally distracted, the output channels are protected against overload and short circuits so that the power supply will not suffer damage. You can set the maximum current, voltage and power separately for each channel. If a preset limit is reached, the affected output channel will be automatically switched off. You are also alerted by a beeping sound and the corresponding icon flashing in the status bar.

Rohde&Schwarz power supplies incorporate a number of protection functions to make sure the DUT and the instrument will not be damaged in the event of a fault. Depending on the power supply model, users can separately configure the following for each channel:

- ▶ Maximum current (overcurrent protection, OCP)
- ▶ Tracking and link functions (FuseLink)
- ▶ Fuse delay
- ▶ Maximum voltage (overvoltage protection, OVP)
- ▶ Maximum power (overpower protection, OPP)
- ▶ Maximum temperature (overtemperature protection, OTP)

### Overcurrent protection (OCP)

To protect sensitive loads, the power supply channels are equipped with electronic fuses that can be set individually for each channel. If the current in a specific channel exceeds the set maximum value, the channel is automatically switched off and the overcurrent symbol flashes. Adjust the delay (sensitivity) and the switch-on response time of the electronic fuses as required for your application.

### Tracking and link functions

When using your instrument to supply bipolar circuits, for example, a convenient tracking function lets you vary the voltage on all channels in parallel. The FuseLink function for overcurrent protection allows you to link fuses across multiple channels. It can be configured to switch off all channels when one of the channels reaches its limit value. It can also be configured so that certain channels remain active, for example to power the fan that cools the DUT.

### Fuse delay

The Rohde&Schwarz power supplies come with electronic fuses whose delay can be adjusted individually for each channel. By controlling the delay, i.e. the time after which a fuse trips in response to a given event, users can control the behavior of their power supplies to prevent premature switch-off of a channel due to a short current spike during operation (see figure on page 18).

### Overvoltage protection (OVP)

If the output voltage on a specific channel exceeds the configured maximum value, the channel is switched off and the corresponding OVP indicator flashes on the display. Depending on the setting, either the voltage configured on the instrument or the voltage measured by the instrument is used as the OVP switch-off threshold.

### Overpower protection (OPP)

Instead of the maximum voltage, the maximum power can be set and used as the switch-off threshold.

### Overtemperature protection (OTP)

The Rohde&Schwarz power supplies have internal over-temperature protection that switches off the affected channel if a thermal overload is imminent.

### Safe and quiet working environment

To reduce noise to a minimum, the Rohde&Schwarz power supplies automatically adjust the fan speed to the load condition, allowing you to work in a quiet environment.

All Rohde&Schwarz power supplies include sockets for 4 mm safety-type banana plugs, as required by an increasing number of laboratories for safety reasons.

## ARBITRARY AND RAMP FUNCTIONS

An arbitrary file stores voltage, current and dwell time for a certain number of points. In addition, the number of repetitions for a defined sequence of points can be specified. This allows, for example, to emulate real-world scenarios using arbitrary functions as voltage or current inputs for testing the resilience of a DUT against variations in supply voltage and current delivery.

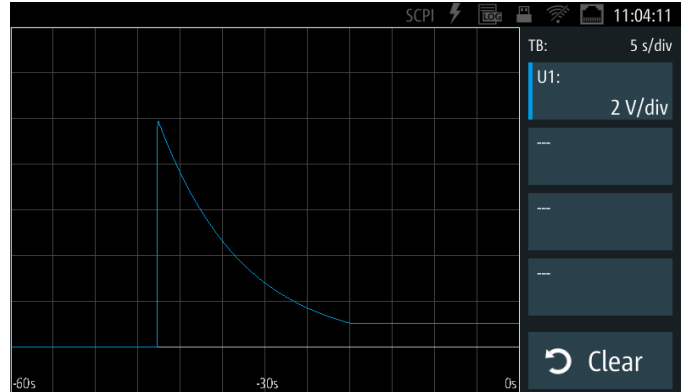

Example of an arbitrary function.

Unlike the arbitrary function, the curve of the ramp function has a fixed shape. The ramp functionality provides a linear “fade-in” curve for the unloaded voltage versus time after switching on the corresponding output channel of the power supply. It can be used to protect circuits from damage by inrush current. The only configurable parameter for the ramp function is the ramp time from switch-on until the full unloaded voltage is reached.

### Configuring fuse delay on Rohde&Schwarz DC power supplies

“Fuse Delay At Output-On” specifies how long a fuse should remain inactive after a channel is switched on. The sensitivity of the fuse is specified by “Fuse Delay Time”.

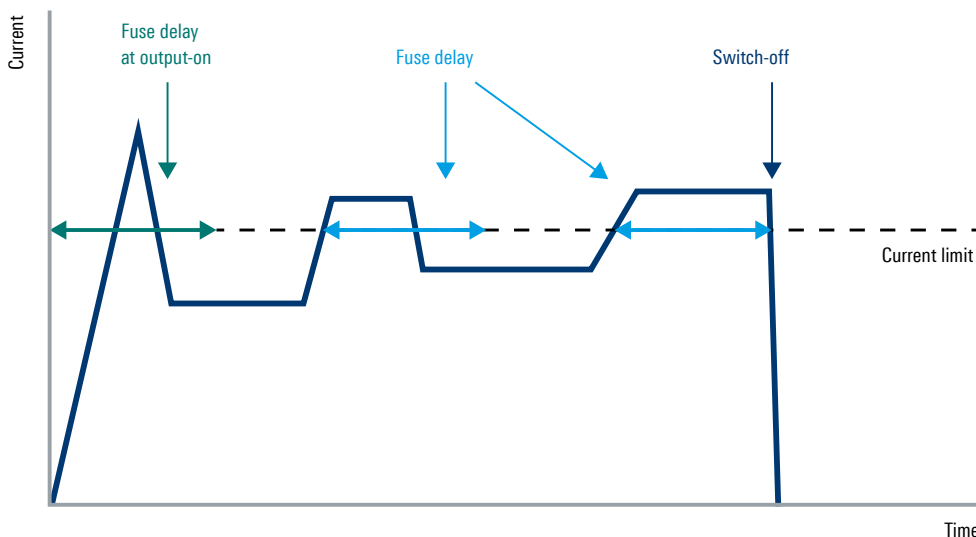

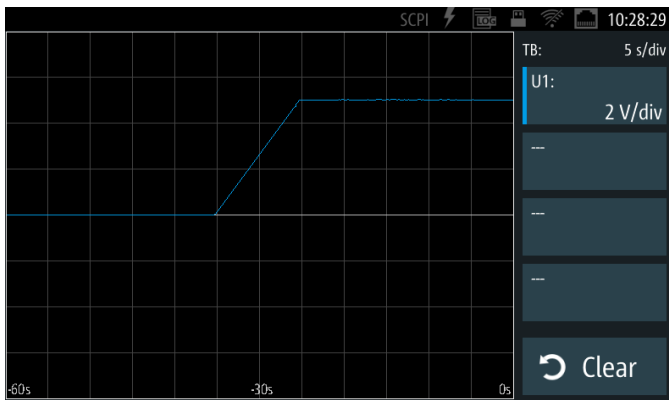

Example of a ramp function.

### Arbitrary and ramp functions with Rohde & Schwarz DC power supplies

DC power supplies from Rohde & Schwarz provide arbitrary functions like EasyArb or QuickArb, and in some cases a somewhat simpler variant of EasyArb (see table on page 20). The parameters for the individual channels are organized according to a defined scheme, providing a certain degree of compatibility between arbitrary files.

The following sections highlight the properties of the EasyArb and QuickArb functions.

#### Properties of EasyArb function

Property	Range
Parameters	voltage, current, dwell time
Maximum number of points	128 or 512 (depending on model)
Dwell time	10 ms to 600 s (10 ms increments)
Repetitions	continuous or burst mode with 1 to 255 repetitions
Trigger (optional)	manual, remote, or via optional digital trigger input
Trigger function	start

#### Properties of QuickArb function

In addition to larger parameter ranges and a higher number of points, the QuickArb function supports subgroups, specification of the end behavior, and linear ramp-shaped interpolation between points. Another advantage is the higher time resolution of 1 ms for both the minimum dwell time and the increments for advancing to the next point.

Property	Range
Parameters	voltage, current, dwell time, interpolate
Maximum number of points	1024, 2048 or 4096 (depending on model)
Maximum number of subgroups	0 or 8 (depending on model)
Dwell time	0.1 ms to 20 h (depending on model)
Repetitions	continuous or burst mode with 1 to 65 535 repetitions
End behavior	hold or output off
Trigger (optional)	manual, remote, or via optional digital trigger input
Trigger functions	start and/or step

With the QuickArb functionality, not only the start of the arbitrary function can be triggered, but also the advancement of a sequence to the next point. This feature is useful, for example, for synchronizing DC voltage sweeps with procedures that take place on measurement equipment.

#### Arbitrary editor

Rohde & Schwarz DC power supplies offer an editor for modifying arbitrary curve shapes on the touchscreen.

The unloaded voltage, current limit and dwell time can be edited for every point in the curve. Additional parameters like the number of repetitions can also be modified.

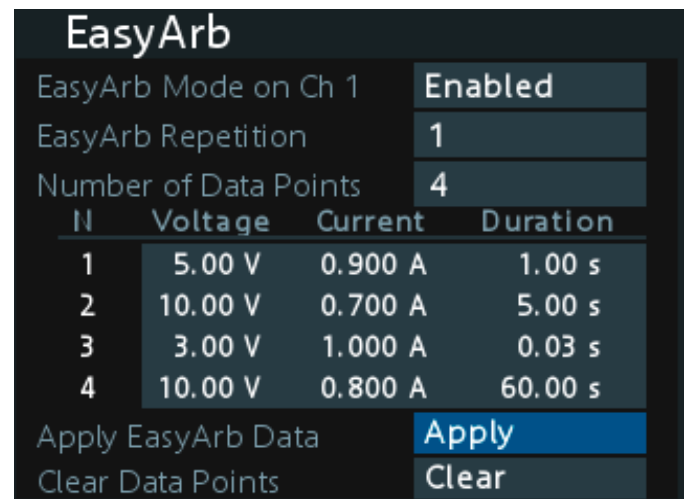

Arbitrary editor on the R&S®NGE100 power supplies.

#	Voltage	Current	Time	Interpolate
1	10.000 V	0.010 0 A	1.000 s	<input checked="" type="checkbox"/>
2	9.048 V	0.009 0 A	1.000 s	<input checked="" type="checkbox"/>
3	8.187 V	0.008 2 A	1.000 s	<input checked="" type="checkbox"/>
4	7.408 V	0.007 4 A	1.000 s	<input checked="" type="checkbox"/>

Arbitrary editor on the R&S®NGM200 power supplies.

With the QuickArb editor, arbitrary curves can be stored to and loaded from ASCII files with character-separated values (CSV). With the EasyArb function, arbitrary curves are stored together with the global instrument settings.

Arbitrary curves can also be loaded into the DC power supply via remote control, for example using the R&S®HMEexplorer software.

	A	B	C	D
1	Column1	Column2	Column3	Column4
2	#Device	NGM202		
3	#Device Name			
4	#Format	ARB		
5	#Date			
6	#Rep	1		
7	#EP	24		
8	#Version			
9	#Serial No.			
10	#EndBehavior	Hold		
11	Voltage	Current	Time	Interp
12	10.000000	0.010000	1.000000	true
13	9.048000	0.009048	1.000000	true
14	8.187000	0.008187	1.000000	true
15	7.408000	0.007408	1.000000	true
16	6.703000	0.006703	1.000000	true
17	6.065000	0.006065	1.000000	true

Example of an ASCII CSV file stored from the QuickArb editor.

### EasyRamp

The ramp time can be selected between 10 ms and 10 s in 10 ms increments.

### Arbitrary function overview

The table below shows the arbitrary functions supported by Rohde&Schwarz DC power supplies.

The arbitrary function on the R&S®HMP2000 and R&S®HMP4000 is similar to EasyArb, with a maximum dwell time of 60 s.

### Arbitrary functions supported by Rohde & Schwarz DC power supplies

Arbitrary functions	Power supplies (R&S®)								
	NGE100B	HMC804x	NGA100	HMP2000	HMP4000	NGP800	NGL200	NGM200	NGU201/401
EasyArb	•	•	•						
QuickArb						•	•	•	•
Other arbitrary function				•	•				
EasyRamp	•	•	•			•	•	•	•

### Can I use the arb functionality on a DC power supply instead of an arbitrary function generator and vice versa?

This highly depends on the application. The table below can serve as a decision-making aid.

### Comparison of arbitrary functionality properties of a DC power supply and an arbitrary function generator

Property	Arbitrary functionality on a DC power supply	Arbitrary function generator, e.g. R&S®HMF2550
Sample rate	1 ksample/s	up to 250 Msample/s
Bandwidth	approx. 500 Hz	up to 50 MHz
Curve length	up to 4096 points	number of points in the million range
Bipolar output (negative output voltage possible)	requires four-quadrant power supply	yes
Output power	up to 160 W	up to 0.5 W (10 V (peak) into 50 Ω)
Signal purity	not specified	THD < 0.04% up to 100 kHz

# PRECISION MADE EASY



## R&S® ESSENTIALS

Developers and engineers worldwide have been relying on the T&M expertise of Rohde & Schwarz for more than 80 years. The company is known for providing innovative performance testing solutions and applies its expertise and high quality standards to its portfolio of essential bench instruments – the R&S® Essentials. Rohde & Schwarz is building this industry-defining portfolio, ranging from oscilloscopes, DC power supplies and signal generators to spectrum analyzers, vector network analyzers, meters and counters with the strategic goal of becoming a full portfolio supplier in the T&M market. For R&S® Essentials, Rohde & Schwarz is extending its reach through a distribution network with channel partners worldwide, offering a one-stop shop experience for any type of T&M task, application and budget. Whether in the lab or field, on campus or in a production facility, R&S® Essentials demonstrate that high-quality hardware and software solutions do not have to come with a high price tag.

# INDEX

Term	Page
Analog input	16
Arbitrary	14, 18
CC	6
CR	6
CV	6
EasyArb	19
EasyRamp	20
Ethernet	13, 15
Fast logging	12
FlexPower	6
Fuse	16, 17, 18
GPIO	14, 15
Graphical View	10
HMEexplorer	20
Impedance	4
Instrument drivers	15
Interfaces	14, 15, 16
LAN	14, 15, 16
Logging	12

Term	Page
Measurement	8, 9
Modulation	15, 17
Multimeter	9
Noise	2, 4, 18
Oscilloscope	9, 10, 13
Protection	16, 17, 18
QuickArb	16, 19, 20
Ripple	2, 4
Ramp	19, 20
Remote control	13, 14, 15, 16
Remote sensing	8
SCPI	15
Standard logging	12
Statistics	9
Trigger	4, 12, 14, 16, 19
USB	13, 14, 15
VISA	16
Voltmeter	9

## Service that adds value

- ▶ Worldwide
- ▶ Local and personalized
- ▶ Customized and flexible
- ▶ Uncompromising quality
- ▶ Long-term dependability

## Rohde & Schwarz

The Rohde&Schwarz technology group is among the trail-blazers when it comes to paving the way for a safer and connected world with its leading solutions in test & measurement, technology systems and networks&cybersecurity. Founded more than 85 years ago, the group is a reliable partner for industry and government customers around the globe. The independent company is headquartered in Munich, Germany and has an extensive sales and service network with locations in more than 70 countries. [www.rohde-schwarz.com](http://www.rohde-schwarz.com)

## Sustainable product design

- ▶ Environmental compatibility and eco-footprint
- ▶ Energy efficiency and low emissions
- ▶ Longevity and optimized total cost of ownership

Certified Quality Management  
**ISO 9001**

Certified Environmental Management  
**ISO 14001**

## Rohde & Schwarz training

[www.training.rohde-schwarz.com](http://www.training.rohde-schwarz.com)

## Rohde & Schwarz customer support

[www.rohde-schwarz.com/support](http://www.rohde-schwarz.com/support)

