

OnBoard 2.4 GHz Mini SMD - EVB



PRO-EB-609

Request Samples



Check Inventory



48.0 x 18.0 mm

RoHS/RoHS II Compliant

MSL Level = 1

Description

The PRO-EB-609 evaluation board is designed to provide a means to facilitate engineering evaluation of the OnBoard 2.4 GHz Mini SMD antenna: PRO-OB-607. With a typical operating frequency range of 2.40~2.49 GHz, the antenna can be used for WiFi/BT/BLE/ZigBee/ISM applications.

To evaluate the performance of antenna, calibrate the Vector Network analyzer (VNA) for the testing frequency band and connect the evaluation board to the calibrated port using the given SMA connector on the board.

Product Images

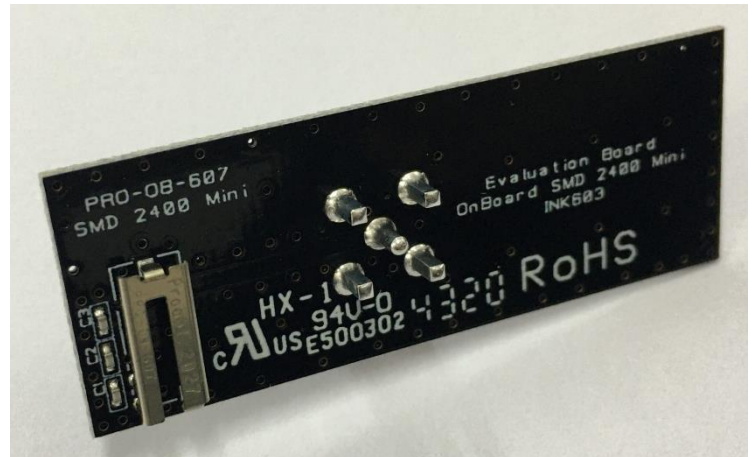
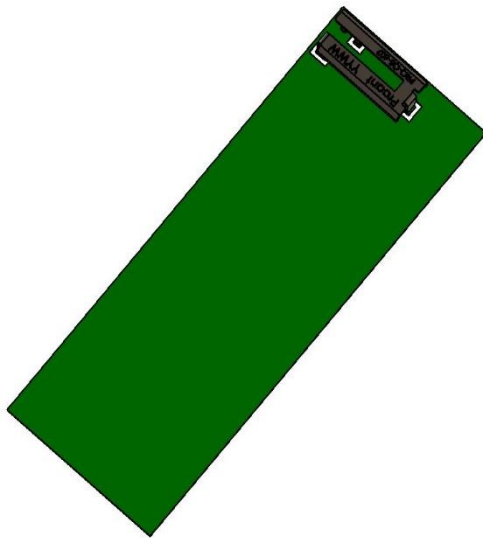

Antenna Image

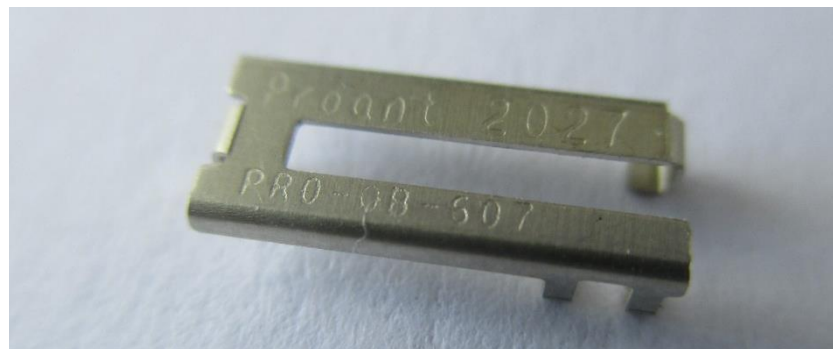

OnBoard 2.4 GHz Mini SMD - EVB



PRO-EB-609

Request Samples



Check Inventory



48.0 x 18.0 mm

RoHS/RoHS II Compliant

MSL Level = 1

Electrical Specification

Parameter	Specification	Unit
Operating Frequency	2400 - 2497	MHz
Return Loss	< -6.3	dB
Polarization	Mixed Linear	-
Peak Gain	-0.6	dBi
Efficiency	> 23	%
Impedance	50	Ω

Note: All measurements were conducted on the evaluation board in free space. Performance will vary depending on the ground plane, application, and environment.

Mechanical Specification

Parameter	Specification
Evaluation board Dimension	48.0 x 18.0 mm



5101 Hidden Creek Ln Spicewood TX 78669
Phone: 512-371-6159 | Fax: 512-351-8858
For terms and conditions of sales, please visit:
www.abracon.com

REVISED:

ABRACON IS
ISO9001-2015
CERTIFIED

OnBoard 2.4 GHz Mini SMD - EVB



PRO-EB-609

Request Samples



Check Inventory



48.0 x 18.0 mm

RoHS/RoHS II Compliant

MSL Level = 1

Antenna Dimensions

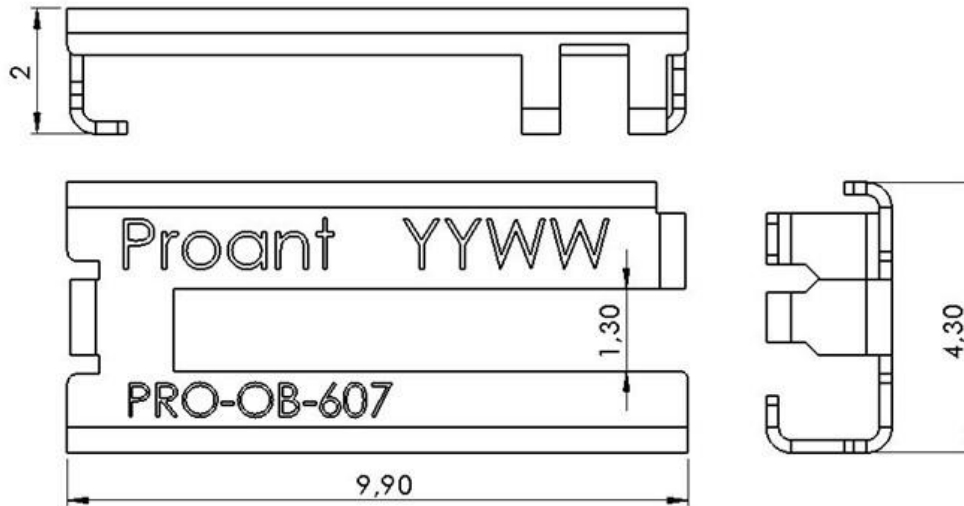

Unit : mm

Antenna pins and keep-out block

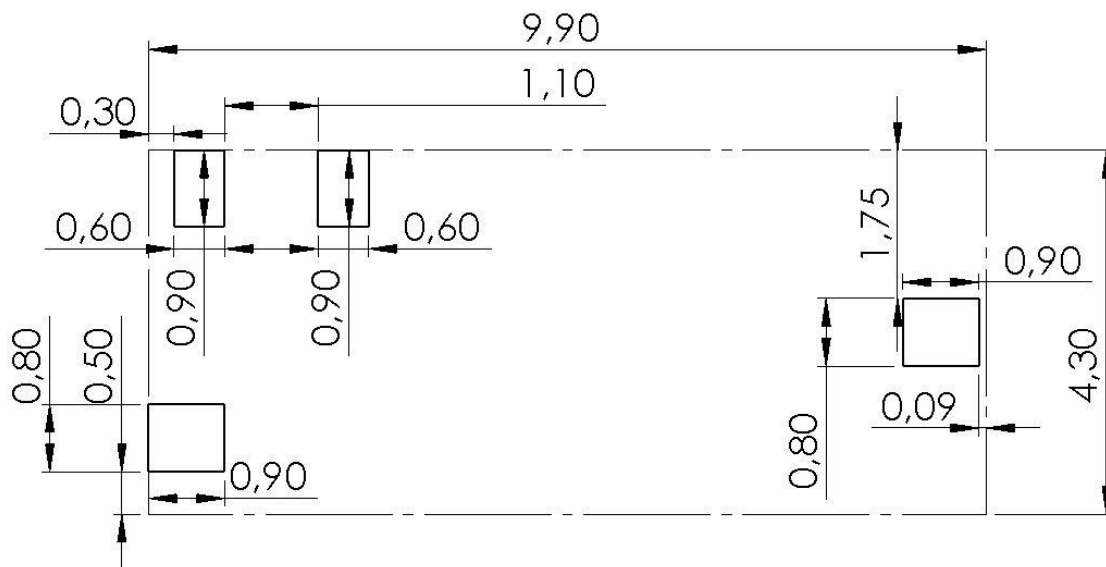

Unit : mm



5101 Hidden Creek Ln Spicewood TX 78669
Phone: 512-371-6159 | Fax: 512-351-8858
For terms and conditions of sales, please visit:
www.abracon.com

REVISED:

ABRACON IS
ISO9001-2015
CERTIFIED



PRO-EB-609

Request Samples



Check Inventory



48.0 x 18.0 mm

RoHS/RoHS II Compliant

MSL Level = 1

PCB layout and antenna pin numbering

The antenna uses PIFA technology and should thus be mounted on a ground plane. If there are several layers in the PCB, there is an advantage to add vias for smooth interconnection of the ground areas to avoid splits in the ground plane. It is also important that there is a ground clearance around the NC pads and the RF feed pad, through all layers of the PCB. It is recommended to implement a matching network to optimize the antenna impedance in your application. The components can be positioned under the antenna. See recommendations in the figures below.



4 ■

1 = GND

2 = RF FEED

3 = NC

4 = NC

Pin configuration

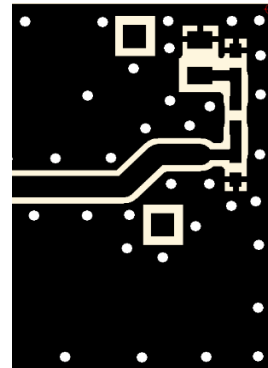

PCB Layout (from evaluation board)

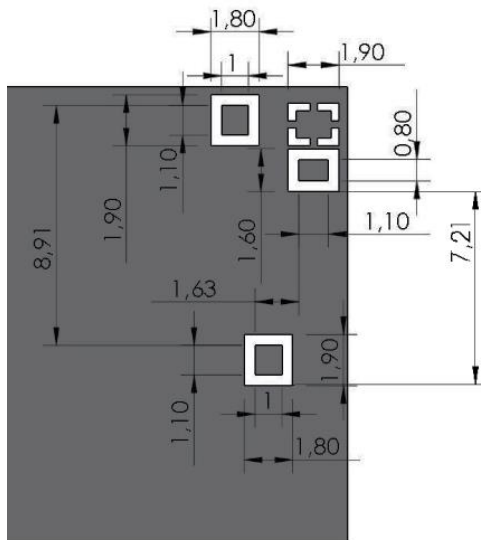

Top Layer

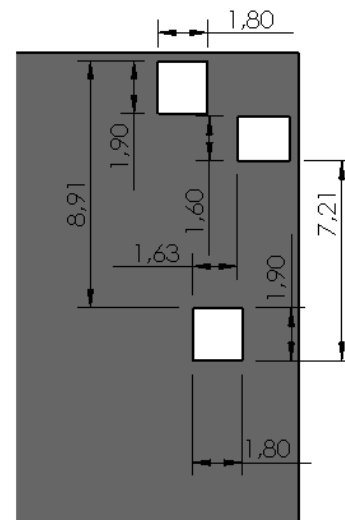

Bottom Layer (Clearance through all layer)

Note: Overall Evaluation Board dimensions: 48 x 18 mm.

Unit: mm

OnBoard 2.4 GHz Mini SMD - EVB



PRO-EB-609

Request Samples



Check Inventory



48.0 x 18.0 mm

RoHS/RoHS II Compliant

MSL Level = 1

Measurement Setup

The antenna measurements were all done in free space with the SMD 2400 Mini evaluation board (PRO-EB-609) that has a PCB size of 48 x 18 mm.



OnBoard 2.4 GHz Mini SMD - EVB



PRO-EB-609

Request Samples



Check Inventory



48.0 x 18.0 mm

RoHS/RoHS II Compliant

MSL Level = 1

Reflection Characteristics – Return Loss

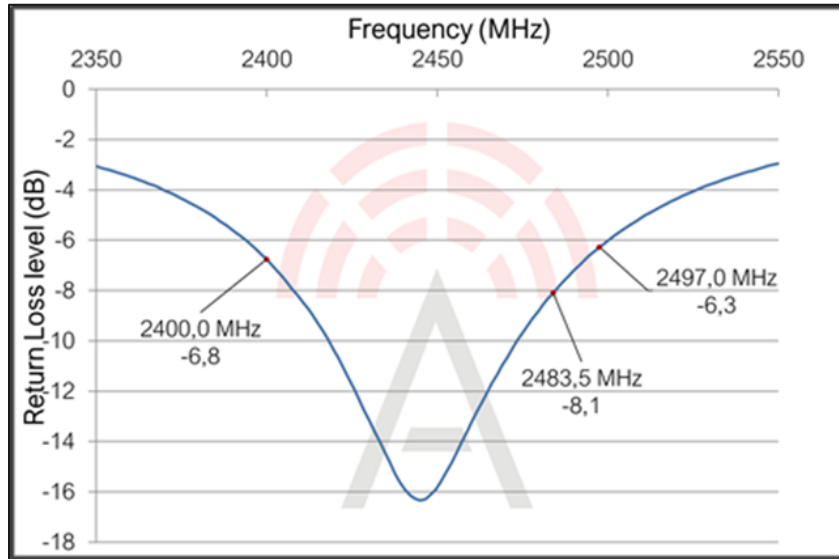

Total Radiation Efficiency

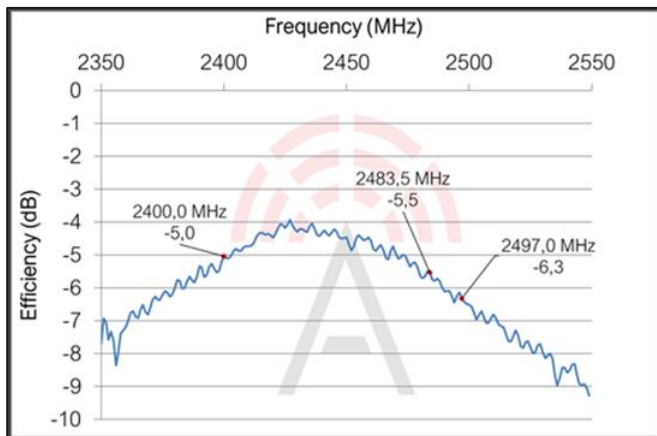

Maximum Radiation Gain

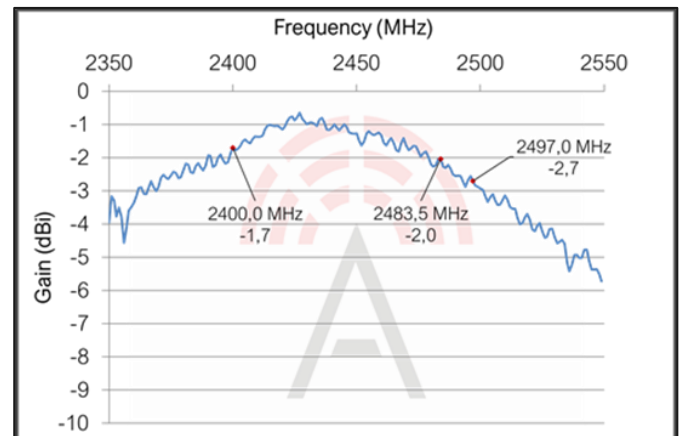

5101 Hidden Creek Ln Spicewood TX 78669
Phone: 512-371-6159 | Fax: 512-351-8858
For terms and conditions of sales, please visit:
www.abracon.com

REVISED:

ABRACON IS
ISO9001-2015
CERTIFIED



PRO-EB-609

Request Samples



Check Inventory



48.0 x 18.0 mm

RoHS/RoHS II Compliant

MSL Level = 1

Radiation Characteristics – 2D Pattern (2400 MHz)

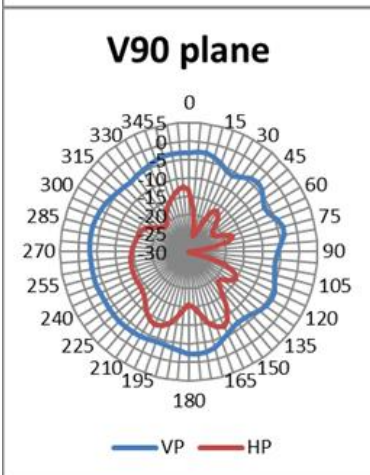
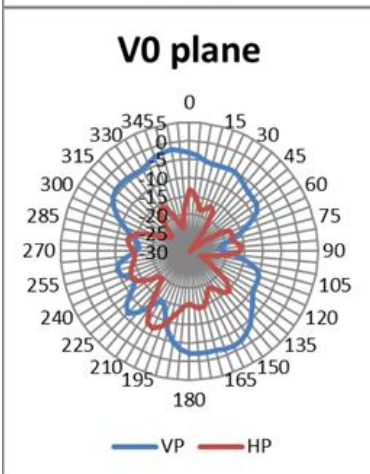
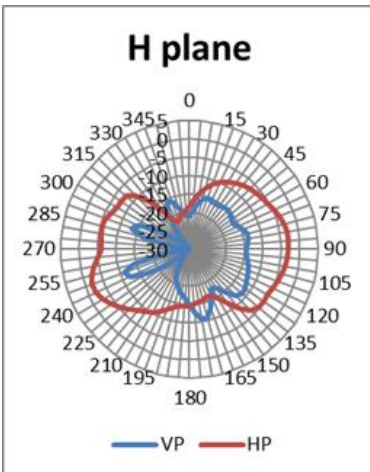

VP: Vertical Polarization
HP: Horizontal Polarization



Unit: dBi



PRO-EB-609

Request Samples



Check Inventory



48.0 x 18.0 mm

RoHS/RoHS II Compliant

MSL Level = 1

Radiation Characteristics – 2D Pattern (2497 MHz)

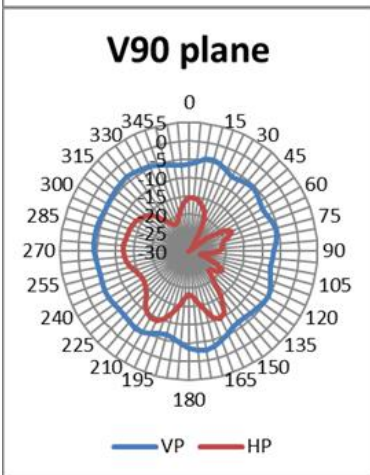
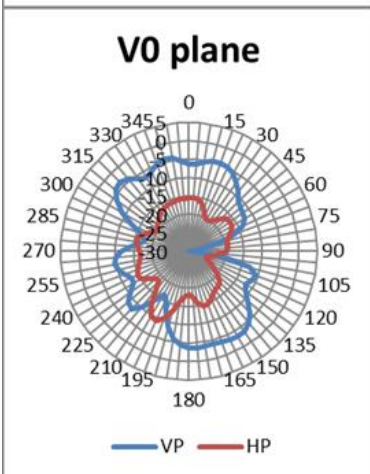
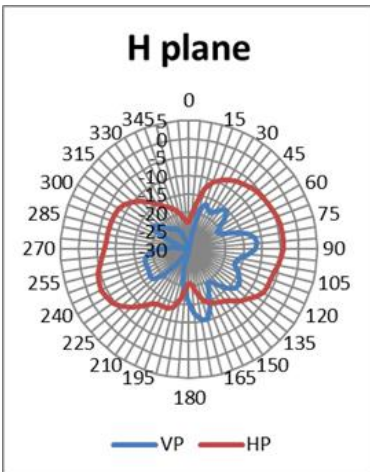

VP: Vertical Polarization
HP: Horizontal Polarization



Unit: dBi



PRO-EB-609

Request Samples



Check Inventory



48.0 x 18.0 mm

RoHS/RoHS II Compliant

MSL Level = 1

Evaluation Board Outline & Matching Circuit

The evaluation board (PRO-EB-609) is developed to simplify antenna testing and evaluation. It has an arbitrary size of 48 x 18 mm and includes an SMA connector. The purpose is to give a reference design for an optimal antenna implementation. The evaluation board can also be used to test other implementations by cutting and soldering the PCB into any device.

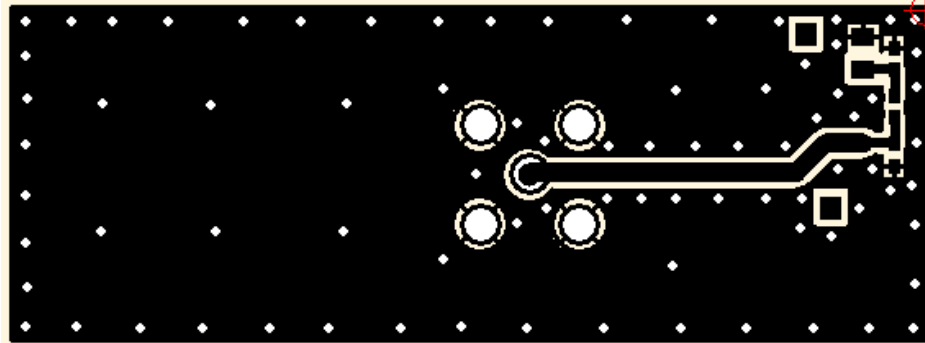

Evaluation board outline

The evaluation board has a matching circuit implemented next to the antenna. This is aimed to enable optimization possibilities for the user. The component positions are sized for 0402 (1005 metric) SMD components.

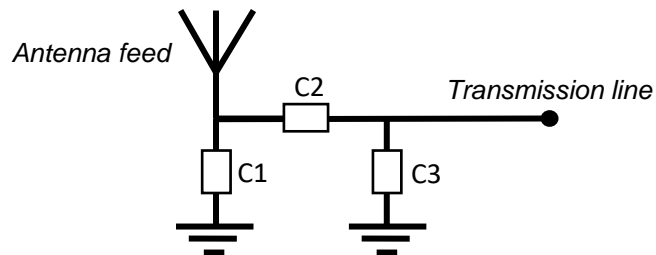

Matching circuit

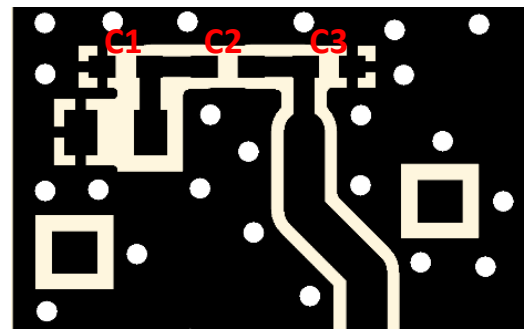

The antenna needs a matching circuit to adjust the resonant frequency balance. When delivered, the evaluation board is tuned for optimum balance at the 2.4 GHz band. The component values for this setup are:

$$C1 = 0.4 \text{ pF}$$

$$C2 = 0.6 \text{ pF}$$

$$C3 = 1.1 \text{ pF}$$

However, it is common that the resonant frequency will shift during implementation in an arbitrary device. Therefore, this matching may be changed for compensation of such effects. This is further described in General Implementation Guidelines section below.



PRO-EB-609

Request Samples



Check Inventory



48.0 x 18.0 mm

RoHS/RoHS II Compliant

MSL Level = 1

General Implementation Guidelines

The antenna can be positioned in different ways, although there are some positions which are more beneficial. Below picture shows a typical PCB with examples on different antenna positions. The optimal position is option 1 or 4.

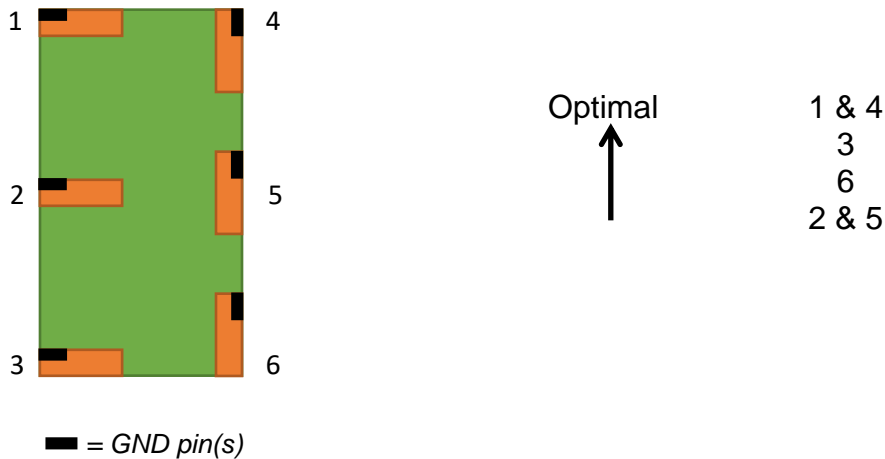

The antenna should be aligned with the PCB edge if possible, preferably with the GND pin(s) close to a corner.

The antenna enables that small electrical components are mounted inside the antenna keep-out block. This is a space-efficient solution which has very little influence on the performance. It may have an impact on the antenna tuning, but is fully possible if there is limited space on the PCB.

Another general aspect on surface mounted antennas is regarding the PCB population. If other electrical components are positioned in the surrounding area of the antenna, some impact on the antenna tuning and radiated performance may be expected. It is recommended that such components are distributed below a topographical slope that starts on PCB level at the antenna keep-out block, and slowly increases the height.

It shall also be highlighted that plastic and metal parts in the near proximity of antennas may influence the antenna tuning and/or performance. This aspect should be noted as a general guideline for all antennas. The effects are difficult to estimate without detailed information, but it is common that a plastic housing above the antenna shifts the resonant frequency down. It is recommended to measure the antenna in the actual device after implementation.

OnBoard 2.4 GHz Mini SMD - EVB



PRO-EB-609

Request Samples



Check Inventory



48.0 x 18.0 mm

RoHS/RoHS II Compliant

MSL Level = 1

Packaging

1 pcs/box.

Ordering Information

Part number	Part name	Details
PRO-OB-607	OnBoard SMD 2400 Mini	Antenna for 2.4 GHz ISM band.
PRO-EB-609	Evaluation board, Onboard SMD 2400 Mini	Evaluation board with PRO-OB-607 for WLAN/Wifi, Bluetooth, Zigbee, RFID, WirelessHART applications.

ATTENTION: Abracon LLC's products are COTS – Commercial-Off-The-Shelf products; suitable for Commercial, Industrial and, where designated, Automotive Applications. Abracon's products are not specifically designed for Military, Aviation, Aerospace, Life-dependent Medical applications or any application requiring high reliability where component failure could result in loss of life and/or property. For applications requiring high reliability and/or presenting an extreme operating environment, written consent and authorization from Abracon LLC is required. Please contact Abracon LLC for more information.



5101 Hidden Creek Ln Spicewood TX 78669
Phone: 512-371-6159 | Fax: 512-351-8858
For terms and conditions of sales, please visit:
www.abracon.com

REVISED:

ABRACON IS
ISO9001-2015
CERTIFIED