

EPM25-1V 15 W

15 Watt isolated DC-DC converter



Product features

- 15 Watt isolated DC-DC converter
- Input voltage: 9 Vdc - 36 Vdc
18 Vdc - 75 Vdc
- Efficiency up to 90%
- Isolation voltage: 1.6 kVdc
- 1.0" x 1.0" package
- Operating ambient temperature from -40 °C to +105 °C
- No minimum load required
- EMI class A without external circuit
- Remote On/OFF
- IEC62368-1/ EN55032&35 certified

Applications

- Computing/telecom
- Distributed power architectures
- Servers and workstations
- LAN / WAN applications
- Data processing applications
- Industrial IoT equipment, sensors
- Power supply, battery backup
- Wireless TX/RX modules
- Renewable energy products

Environmental compliance



Ordering part number

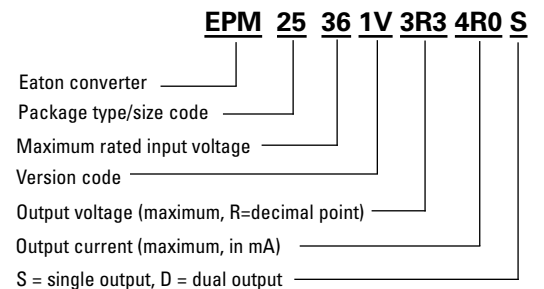

Powering Business Worldwide

Specifications

	Parameter	Conditions	Minimum	Typical	Maximum	Unit
Input	Input filter			Pi type		
	Input voltage range	V _{in} = 24 Vdc	9		36	Vdc
		V _{in} = 48 Vdc	18		75	Vdc
	Input current @ no load	V _{in} = 24 Vdc		7		mA
		V _{in} = 48 Vdc		5		mA
	Start-up time	100% Load at Nominal V _{in}		20		ms
	Start-up voltage	V _{in} = 24 Vdc			9	Vdc
		V _{in} = 48 Vdc			18	Vdc
	UVLO	V _{in} = 24 Vdc		7.5		Vdc
		V _{in} = 48 Vdc		16		Vdc
	Input surge voltage (0.1 s max.)	V _{in} = 24 Vdc			50	Vdc
		V _{in} = 48 Vdc			100	Vdc
	Remote ON/OFF	DC-DC ON			Open or 3.5 - 15 Vdc	
DC-DC OFF				Short or 0 - 1.2 Vdc		
Input current (remote off mode)			2		mA	
Output	Efficiency			Selection guide		
	Minimum load		0			%
	Line regulation	Single output	-0.2		+0.2	%
		Dual output	-0.5		+0.5	%
	Load regulation (10-100% Load)	Single output	-0.5		+0.5	%
		Dual output	-1.0		+1.0	%
	Cross regulation		-5		+5	%
	Voltage accuracy		-1		+1	%
	Operating frequency	V _{out} = 3.3 Vdc		400		kHz
		others		350		kHz
	Ripple & noise ¹	V _{in} = 24 Vdc			60	mVp-p
V _{in} = 48 Vdc				100	mVp-p	
Voltage adjustability		-10		+10	%	
Environment	Operating temperature (with derating)		-40		+105	°C
	Storage temperature		-55		+125	°C
	Max. case temperature				110	°C
	Relative humidity		5		95	%RH
	Vibration				MIL-STD-202G	
Function	Isolation voltage 1 min., Input to Output		1.6			kVdc
	Isolation resistance		1000			MΩ
	Isolation capacitance			1200		pF
	MTBF (MIL-HDBK-217F)	+25 °C		1000		khours
	Short circuit protection			Continuous, automatic recovery		
	Overload protection	V _{in} = 24 Vdc			170	%
		V _{in} = 48 Vdc			190	%
	Certification				IEC62368-1/ EN55032&35	

Specifications

	Parameter	Conditions	Minimum	Typical	Maximum	Unit
Physical	Dimension			1.00 x 1.00 x 0.40 inch		
	Weight			17 g		
	Case material			metal case		
	Base material			FR4 PCB		
	Potting material			Silicone		
EMC	EMI	EN 55032		Class A without external circuit, Class B with external circuit		
	ESD	IEC 61000-4-2 Air ± 8 kV; Contact ± 6 kV		Criteria A		
	RS ²	IEC 61000-4-3, 3 V/m		Criteria A		
	EFT ²	IEC 61000-4-4, ± 2 kV		Criteria A		
	Surge ²	IEC 61000-4-5, ± 2 kV		Criteria A		
	CS ²	IEC 61000-4-6, 3 Vrms		Criteria A		
	PfMF	IEC 61000-4-8, 1 A/m		Criteria A		

1. The ripple & noise are measured with 1 μ F capacitor at 20 MHz BW.
2. Test with E-CAP 220 μ F/100 V at input terminal.
3. All specifications valid at nominal input, full load and +25 °C after warm-up time unless otherwise stated.
4. The product information and specifications are subject to change without prior notice.

Selection guide

Part number	Input voltage (Vdc)	Output voltage (Vdc)	Output current @ full load (mA)	Efficiency ¹ minimum	Efficiency ¹ typical	Capacitive load ² maximum (μF)
EPM25361V-3R3-4R0S	9-36 Nominal 24	3.3	4000	84.00%	85.00%	12000
EPM25361V-05R-3R0S	9-36 Nominal 24	5	3000	87.00%	88.00%	6400
EPM25361V-12R-1R2S	9-36 Nominal 24	12	1250	87.50%	88.50%	1200
EPM25361V-15R-1R0S	9-36 Nominal 24	15	1000	88.00%	89.00%	900
EPM25361V-24R-R62S	9-36 Nominal 24	24	625	88.50%	89.50%	240
EPM25361V-12R-R62D	9-36 Nominal 24	±12	±625	86.00%	87.00%	±520
EPM25751V-3R3-4R0S	18-75 Nominal 48	3.3	4000	84.00%	85.00%	12000
EPM25751V-05R-3R0S	18-75 Nominal 48	5	3000	87.00%	88.00%	6400
EPM25751V-12R-1R2S	18-75 Nominal 48	12	1250	88.00%	89.00%	1200
EPM25751V-15R-1R0S	18-75 Nominal 48	15	1000	88.50%	89.50%	900
EPM25751V-24R-R62S	18-75 Nominal 48	24	625	89.00%	90.00%	240
EPM25751V-12R-R62D	18-75 Nominal 48	±12	±625	88.50%	89.50%	±520

1. Efficiency is nominal input voltage and full load @ +25 °C.

2. Capacitive load is tested at minimum input voltage and a constant resistive load.

3. All specifications valid at nominal input voltage, full load and +25 °C after warm-up time unless otherwise stated.

Measure method

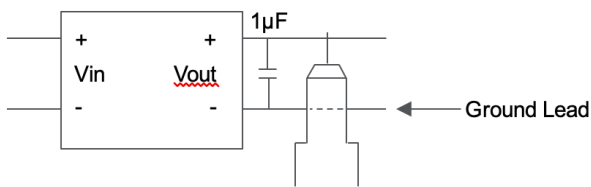

Derating curve

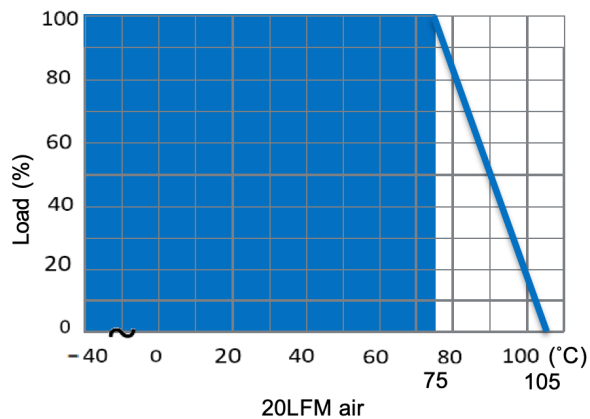

Application information

Single external output voltage trimming

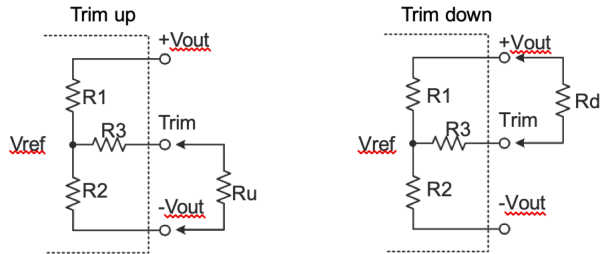

Formula for trim resistor:

$$\text{UP: } R_u = \frac{aR_2}{R_2 - a} - R_3 \quad a = \frac{V_{ref}}{V_0' - V_{ref}} \cdot R_1$$

$$\text{DOWN: } R_d = \frac{bR_1}{R_1 - b} - R_3 \quad b = \frac{V_0' - V_{ref}}{V_{ref}} \cdot R_2$$

1. Ru, Rd is mean trim resistor, please check the formula.
2. a & b: user define parameter
3. V_0' is mean trim up/down voltage.
4. Value for R1, R2, R3 and V_{ref} Refer to the table below.

Output voltage	R1	R2	R3	Vref
3.3 V	16.6 kΩ	10 kΩ	52.3 kΩ	1.24 V
5 V	10.0 kΩ	10 kΩ	35.7 kΩ	2.5 V
12 V	38.1 kΩ	10 kΩ	48.7 kΩ	2.5 V
15 V	50.1 kΩ	10 kΩ	51.0 kΩ	2.5 V
24 V	86.32 kΩ	10 kΩ	73.2 kΩ	2.5 V

Trim up

3R3-04RS

trim (%)	1	2	3	4	5	6	7	8	9	10
Vout (V)	3.333	3.366	3.399	3.432	3.465	3.498	3.531	3.564	3.597	3.63
Ru (kΩ)	542.61	252.19	152.31	101.77	71.25	50.82	36.19	25.2	16.63	9.77

05R-3R0S

trim (%)	1	2	3	4	5	6	7	8	9	10
Vout (V)	5.05	5.1	5.15	5.2	5.25	5.3	5.35	5.4	5.45	5.5
Ru (kΩ)	464.3	214.3	130.97	89.3	64.3	47.63	35.73	26.8	19.86	14.3

12R-1R2S

trim (%)	1	2	3	4	5	6	7	8	9	10
Vout (V)	12.12	12.24	12.36	12.48	12.6	12.72	12.84	12.96	13.08	13.2
Ru (kΩ)	953.93	394.32	235.63	160.64	116.95	88.35	68.17	53.17	41.58	32.36

15R-1R0S

trim (%)	1	2	3	4	5	6	7	8	9	10
Vout (V)	15.15	15.3	15.45	15.6	15.75	15.9	16.05	16.2	16.35	16.5
Ru (kΩ)	951.00	404.45	243.71	166.83	121.76	92.14	71.20	55.60	43.53	33.92

24R-R62S

trim (%)	1	2	3	4	5	6	7	8	9	10
Vout (V)	24.24	24.48	24.72	24.96	25.2	25.44	25.68	25.92	26.16	26.4
Ru (kΩ)	1275.55	466.3	263.99	172.03	119.48	85.48	61.67	44.08	30.55	19.82

Trim down

3R3-4R0S

trim (%)	1	2	3	4	5	6	7	8	9	10
Vout (V)	3.267	3.234	3.201	3.168	3.135	3.102	3.069	3.036	3.003	2.97
Rd (kΩ)	1019.29	461.68	281.91	193.13	140.21	105.07	80.05	61.31	46.77	35.14

05R-3R0S

trim (%)	1	2	3	4	5	6	7	8	9	10
Vout (V)	4.95	4.9	4.85	4.8	4.75	4.7	4.65	4.6	4.55	4.5
Rd (kΩ)	454.3	204.3	120.97	79.3	54.3	37.63	25.73	16.8	9.86	4.3

12R-1R2S

trim (%)	1	2	3	4	5	6	7	8	9	10
Vout (V)	11.88	11.76	11.64	11.52	11.4	11.28	11.16	11.04	10.92	10.8
Rd (kΩ)	2415.98	1282.64	855.8	631.82	493.84	400.32	332.74	281.63	241.62	209.45

15R-1R0S

trim (%)	1	2	3	4	5	6	7	8	9	10
Vout (V)	14.85	14.7	14.55	14.4	14.25	14.1	13.95	13.8	13.65	13.5
Rd (kΩ)	3484.63	1829.68	1219.96	902.9	708.58	577.28	482.62	411.15	355.27	310.38

24R-R62S

trim (%)	1	2	3	4	5	6	7	8	9	10
Vout (V)	23.76	23.52	23.28	23.04	22.8	22.56	22.32	22.08	21.84	21.6
Rd (kΩ)	5661.68	3166.88	2168.96	1631.62	1295.78	1066	898.88	771.87	672.08	591.6

CTRL pin setting

Remote ON/OFF	DC-DC ON	Open or 3.5 - 15 Vdc
	DC-DC OFF	Short or 0 - 1.2 Vdc

If not using CTRL function, leave CTRL pin floating.

If using CTRL pin to control module to turn on and off; use either external circuit as shown below.

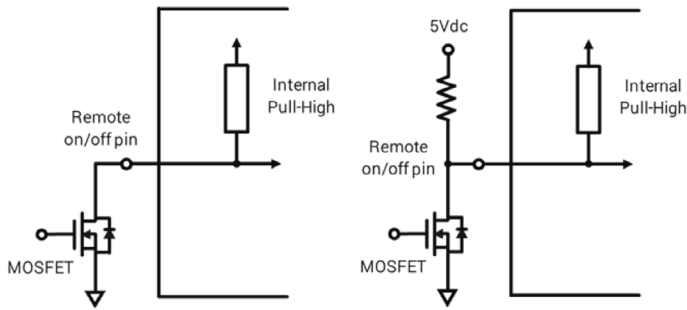

EMC filtering circuit

■ Single

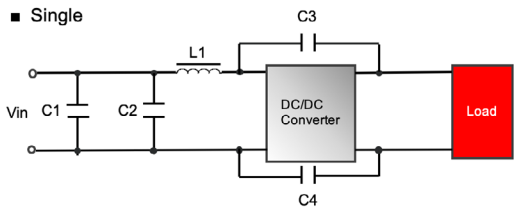

■ Dual

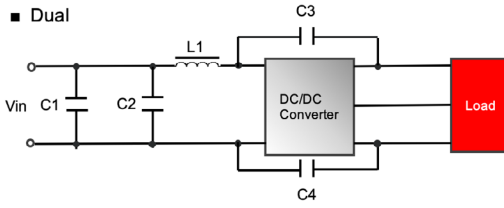

Class B	C1	C2	L1	C3	C4
24 Vin	2.2 μ F	2.2 μ F	4.7 μ H	1500 pF	1500 pF
48 Vin	2.2 μ F	2.2 μ F	4.7 μ H	1500 pF	1500 pF

Packaging- Inches

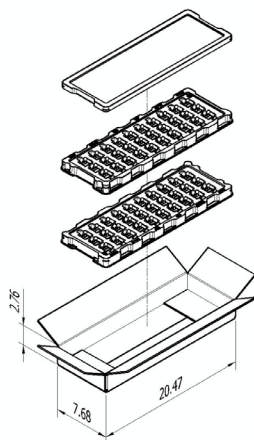

Unit:inch

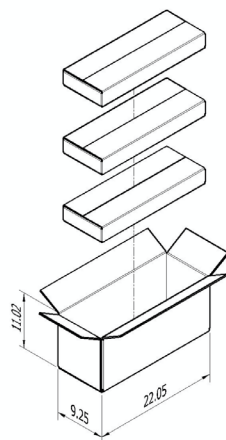

Box accommodates
2 tray 60 converters per box

Carton accommodates
3 boxes 180 converters per carton

Dimensions - inches

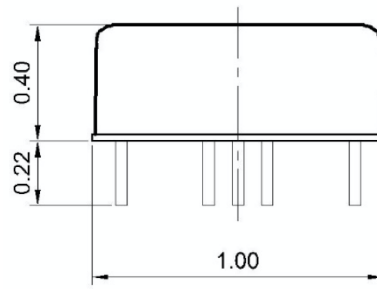
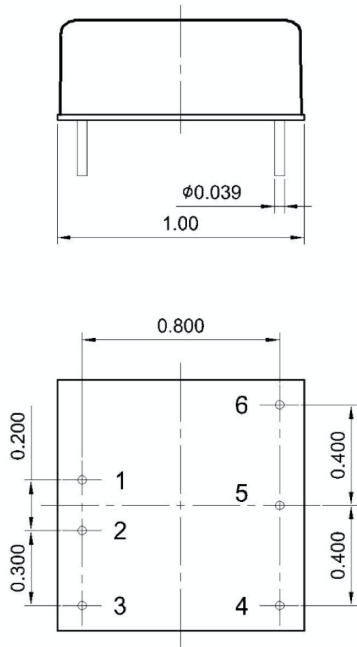

Recommended PCB layout

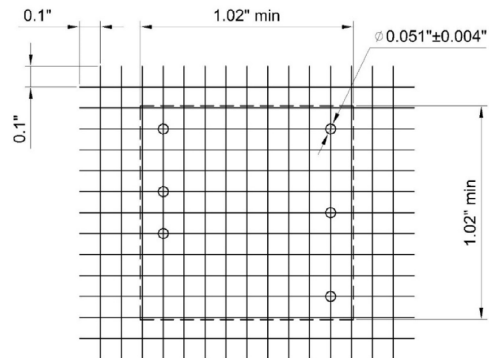

Unit: inch
PIN tolerance: ± 0.004
Tolerance: X.XX ± 0.02 X.XXX ± 0.01

Pin	Single	Dual
1	+Vin	+Vin
2	-Vin	-Vin
3	CTRL	CTRL
4	-Vout	-Vout
5	Trim	Common
6	+Vout	+Vout

Marking

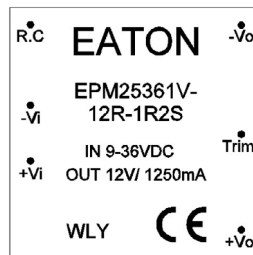

WLY = lot code

General information

Storage and handling

The shelf life will be a minimum of 36 months, when stored at the following conditions: < +40 °C, < 90% RH.

Wave solder profile

The wave solder profile is measured based on lead temperature. The recommended PCB pre-heat temperature is +80 °C to +100 °C, and the preheat rate of 1.5 to 2.5 °C/sec. The underside PCB temperature at the last pre-heat zone should be approximately +150 °C. The internal temperature of the solder parts should not exceed +210 °C. The duration of solder dwell time should be between 3 to 5 seconds, and not to exceed 10 seconds at a temperature of +260 °C maximum.

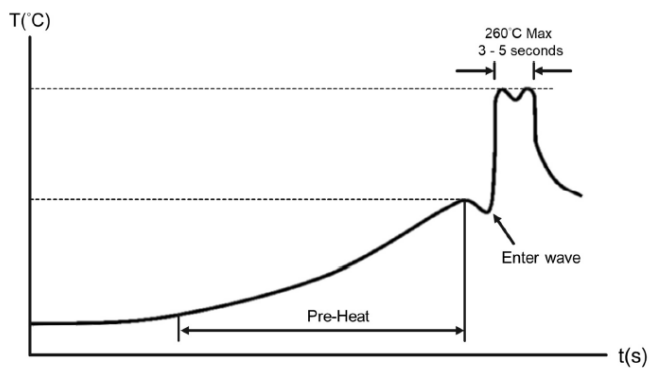

Life Support Policy: Eaton does not authorize the use of any of its products for use in life support devices or systems without the express written approval of an officer of the Company. Life support systems are devices which support or sustain life, and whose failure to perform, when properly used in accordance with instructions for use provided in the labeling, can be reasonably expected to result in significant injury to the user.

Eaton reserves the right, without notice, to change design or construction of any products and to discontinue or limit distribution of any products. Eaton also reserves the right to change or update, without notice, any technical information contained in this bulletin.

Eaton
Electronics Division
1000 Eaton Boulevard
Cleveland, OH 44122
United States
Eaton.com/electronics

© 2022 Eaton
All Rights Reserved
Printed in USA
Publication No. ELX1165 BU-ELX22024
March 2022

Eaton is a registered trademark.

All other trademarks are property of their respective owners.

Follow us on social media to get the latest product and support information.

