

femtoSMDC Series

Surface Mount



Additional Information



Resources



Accessories



Samples

Description

The femtoSMDC series provides surface mount overcurrent protection for applications where space is at a premium and resettable protection is desired.

Features & Benefits

- Broadest range of resettable devices available in industry
- Low resistance
- Small 0603 footprint
- Fast time-to-trip
- RoHS compliant, lead-free and halogen-free

Applications

- Mobile Electronics
- Batteries
- Computer
- Portable electronics
- Multimedia
- Game machines
- Telephone and broadband
- Automotive
- Industrial controls
- Battery

Agency Approvals

Agency	Agency File Number
	E74889
	78165
	72161792 50253253

Electrical Characteristics

Part Number	Ordering Part Number	I_H	I_T	V_{MAX}	I_{MAX}	$P_{D MAX}$	Max Time-to-trip		R_{MIN}	R_{1MAX}
		(A)	(A)	(V _{DC})	(A)	(W)	(A)	(s)	(Ω)	(Ω)
femtoSMDC Series — Size 1608mm/0603mils										
femtoSMDC005F	RF2926-000	0.05	0.15	15	40	0.50	0.50	0.10	3.80	30.00
femtoSMDC008F	RF3692-000	0.08	0.20	12	40	0.50	0.60	0.10	2.80	14.00
femtoSMDC010F	RF3693-000	0.10	0.25	12	40	0.50	0.70	0.10	1.70	8.00
femtoSMDC012F	RF3695-000	0.12	0.30	9	40	0.50	0.80	0.10	1.10	5.80
femtoSMDC016F	RF3696-000	0.16	0.40	9	40	0.50	1.00	0.10	1.00	4.20
femtoSMDC020F	RF2587-000	0.20	0.45	9	40	0.50	2.00	0.10	0.70	3.00
femtoSMDC035F	RF2477-000	0.35	0.70	6	40	0.50	3.50	0.10	0.28	1.00

Notes:

- I_H : Hold current: maximum current device will pass without interruption in 20°C still air.
 I_T : Trip current: minimum current that will switch the device from low resistance to high resistance in 20°C still air.
 V_{MAX} : Maximum continuous voltage device can withstand without damage at rated current.
 I_{MAX} : Maximum fault current device can withstand without damage at rated voltage.
 P_D : Power dissipated from device when in the tripped state in 20°C still air.
 R_{MIN} : Minimum resistance of device as supplied at 20°C unless otherwise specified.
 R_{1MAX} : Maximum resistance measured one hour post-trip or post-reflow at 20°C.

femtoSMDC Series

Surface Mount

Temperature Derating

Maximum Ambient Temperature											
Part Number	-40°C	-20°C	0°C	20°C	25°C	40°C	50°C	60°C	70°C	80°C	85°C
Hold Current (A)											
femtoSMDC Series – Size 1608mm/0603mils											
femtoSMDC005F	0.08	0.07	0.06	0.05	0.05	0.04	0.04	0.03	0.03	0.02	0.02
femtoSMDC008F	0.13	0.11	0.10	0.08	0.08	0.07	0.06	0.06	0.05	0.04	0.04
femtoSMDC010F	0.16	0.14	0.12	0.11	0.10	0.09	0.08	0.07	0.06	0.05	0.04
femtoSMDC012F	0.18	0.16	0.14	0.12	0.12	0.11	0.10	0.08	0.08	0.07	0.06
femtoSMDC016F	0.25	0.22	0.18	0.17	0.16	0.14	0.12	0.11	0.10	0.08	0.07
femtoSMDC020F	0.30	0.27	0.24	0.20	0.20	0.17	0.16	0.14	0.12	0.11	0.10
femtoSMDC035F	0.53	0.47	0.41	0.36	0.35	0.30	0.27	0.25	0.22	0.19	0.17

Note: The average time current curves and Temperature Derating curve performance is affected by a number of variables, and these curves provided as guidance only. Customer must verify the performance in their application.

Temperature Derating Curve

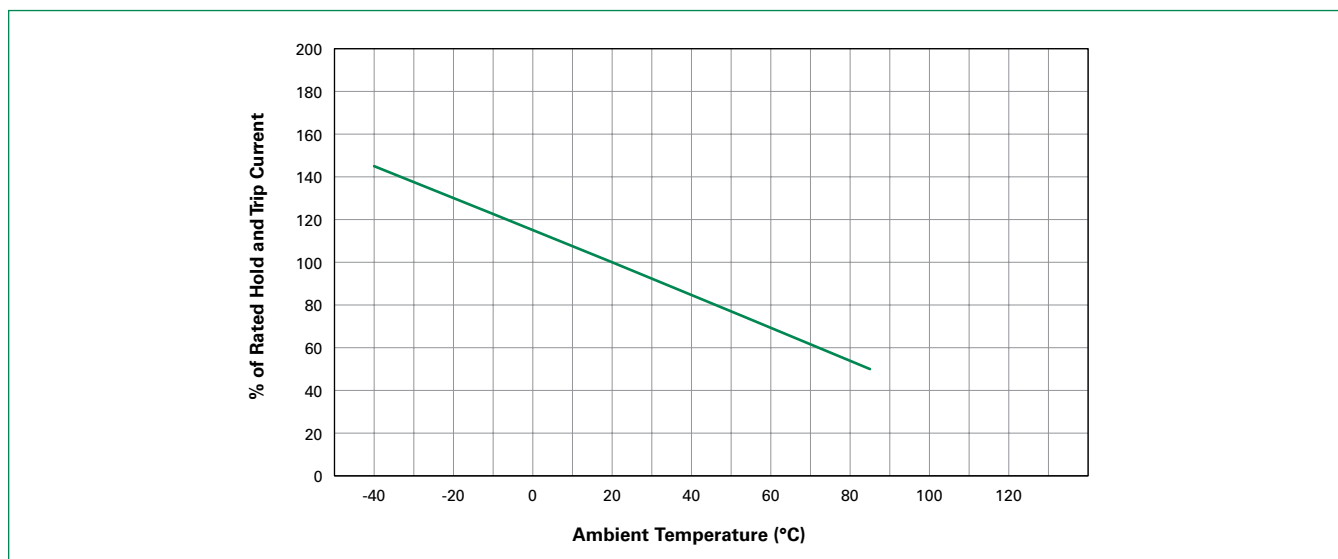

femtoSMDC Series

Surface Mount

Typical Time-to-Trip Curves at 20°C

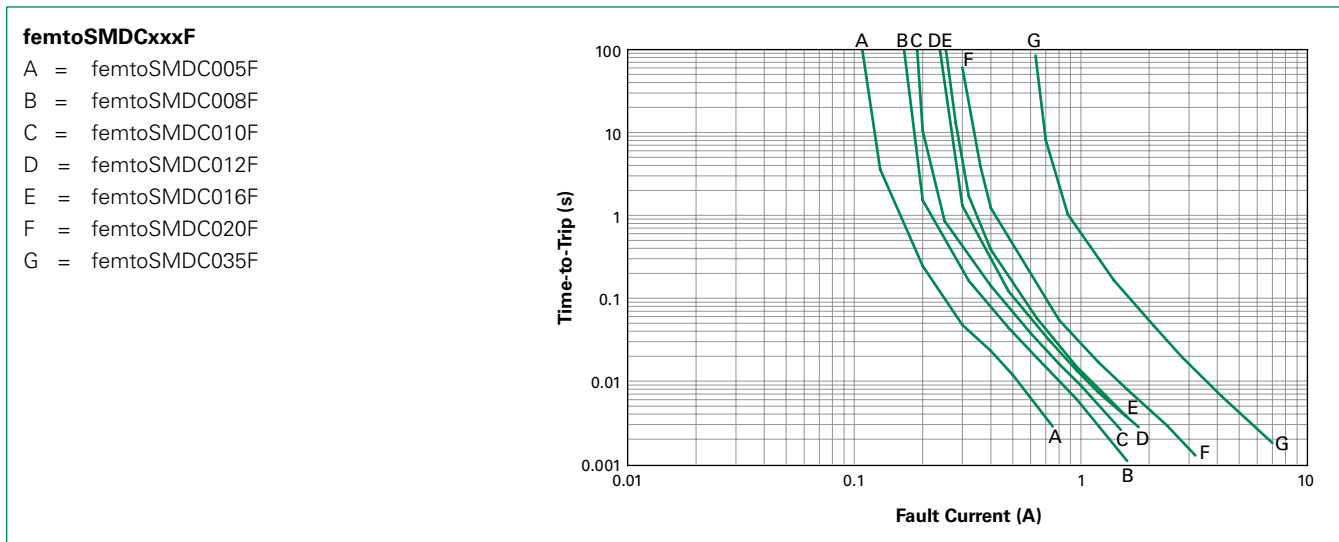

Physical Specifications

Terminal Pad Material	100% Matte Tin with Nickel Underplate
Soldering Characteristics	ANSI/J-STD-002 Category 3
Solder Heat Withstand	per IEC-STD 68-2-20, Test Tb, Section 5, Method 1a
Flammability Resistance	per IEC 695-2-2 Needle Flame Test for 20 seconds

Environmental Specifications

Test	Test Method	Conditions	Resistance Change
Storage Life	PS300, Section 5.3.2	60°C, 1000 hrs 85°C, 1000 hrs	±3% typ ±3% typ
Humidity Aging	PS300, Section 5.3.1	85°C, 85% R.H., 100 hrs	±1.2% typ
Thermal Shock	MIL-STD-202, Method 107G	85°C, -40°C (20 Times) 125°C, -55°C (10 Times)	-33% typ -33% typ
Vibration	MIL-STD-883C	per MIL-STD-883C	No Change
Solvent Resistance	PS300, Section 5.2.2	Freon Trichloroethane Hydrocarbons	No Change No Change No Change

Moisture Resistance Level	Level 1, J-STD-020
Storage Conditions	40°C max, 70% RH max; devices should remain in original sealed bags prior to use. Devices may not meet specified values if these storage conditions are exceeded.

femtoSMDC Series

Surface Mount

Dimension Figures

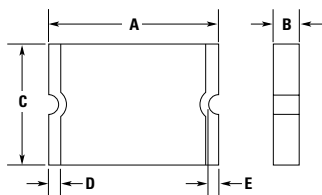
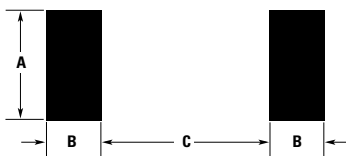

Figure 1

Dimension

Part Number	Dimensions in Millimeters (Inches)										Figure
	A		B		C		D		E		
	Min	Max	Min	Max	Min	Max	Min	Max	Min	Max	
femtoSMDC Series — Size 1608mm/0603mils											
femtoSMDC005F	1.40 (0.055)	1.80 (0.071)	0.45 (0.017)	0.85 (0.033)	0.60 (0.023)	1.00 (0.039)	0.10 (0.004)	0.50 (0.020)	0.075 (0.003)	—	1
femtoSMDC008F	1.40 (0.055)	1.80 (0.071)	0.45 (0.017)	0.85 (0.033)	0.60 (0.023)	1.00 (0.039)	0.10 (0.004)	0.50 (0.020)	0.075 (0.003)	—	1
femtoSMDC010F	1.40 (0.055)	1.80 (0.071)	0.45 (0.017)	0.85 (0.033)	0.60 (0.023)	1.00 (0.039)	0.10 (0.004)	0.50 (0.020)	0.075 (0.003)	—	1
femtoSMDC012F	1.40 (0.055)	1.80 (0.071)	0.35 (0.013)	0.75 (0.030)	0.60 (0.023)	1.00 (0.039)	0.10 (0.004)	0.50 (0.020)	0.075 (0.003)	—	1
femtoSMDC016F	1.40 (0.055)	1.80 (0.071)	0.35 (0.013)	0.75 (0.030)	0.60 (0.023)	1.00 (0.039)	0.10 (0.004)	0.50 (0.020)	0.075 (0.003)	—	1
femtoSMDC020F	1.40 (0.055)	1.80 (0.071)	0.35 (0.013)	0.75 (0.030)	0.60 (0.023)	1.00 (0.039)	0.10 (0.004)	0.50 (0.020)	0.075 (0.003)	—	1
femtoSMDC035F	1.40 (0.055)	1.80 (0.071)	0.55 (0.021)	0.95 (0.037)	0.60 (0.023)	1.00 (0.039)	0.10 (0.004)	0.50 (0.020)	0.075 (0.003)	—	1

Recommended Pad Layout



Packaging and Marking Information

Part Number	Tape and Reel Quantity	Standard Package	Part Marking	Dimension A (Nom)	Dimension B (Nom)	Dimension C (Nom)	Agency Recognition
femtoSMDC Series — Size 1608mm/0603mils							
femtoSMDC005F	4,000	20,000	A	0.80 (0.032)	0.60 (0.024)	0.80 (0.032)	UL, CSA
femtoSMDC008F	4,000	20,000	T	0.80 (0.032)	0.60 (0.024)	0.80 (0.032)	UL, CSA, TÜV
femtoSMDC010F	4,000	20,000	B	0.80 (0.032)	0.60 (0.024)	0.80 (0.032)	UL, CSA, TÜV
femtoSMDC012F	5,000	25,000	C	0.80 (0.032)	0.60 (0.024)	0.80 (0.032)	UL, CSA
femtoSMDC016F	5,000	25,000	E	0.80 (0.032)	0.60 (0.024)	0.80 (0.032)	UL, CSA
femtoSMDC020F	5,000	25,000	F	0.80 (0.032)	0.60 (0.024)	0.80 (0.032)	UL, CSA, TÜV
femtoSMDC035F	4,000	20,000	K	0.80 (0.032)	0.60 (0.024)	0.80 (0.032)	UL, CSA

femtoSMDC Series

Surface Mount

Solder Reflow Recommendations

Profile Feature	Pb-Free Assembly
Average ramp up rate (Ts_{MAX} to Tp)	3°C/s max
Preheat	-
• Temperature min (Ts _{MIN})	150°C
• Temperature max (Ts _{MAX})	200°C
• Time (ts _{MIN} to ts _{MAX})	60-120 s
Time maintained above:	-
• Temperature (T _L)	217°C
• Time (t _L)	60-150 s
Peak/Classification temperature (Tp)	260°C
Time within 5°C of actual peak temperature	-
Time (tp)	30 s max
Ramp down rate	3°C/s max
Time 25°C to peak temperature	8 min max

Note: All temperatures refer to topside of the package, measured on the package body surface.

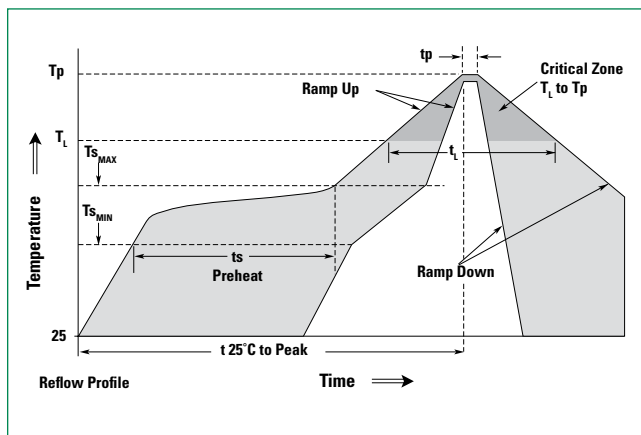

Solder Reflow

- Recommended reflow method: IR, hot air, nitrogen.
- Recommended maximum paste thickness: 0.25mm (0.010in)
- Devices can be cleaned using standard methods and aqueous solvents.
- Experience has shown the optimum conditions for forming acceptable solder fillets occur when a reasonable amount of solder paste is placed underneath each device's termination. As such, we request that customers comply with our recommended solder pad layouts.
- Customer should validate that the solder paste amount and reflow recommendations meet its application.
- We request that customer board layouts refrain from placing raised features (e.g. vias, nomenclature, traces, etc.) underneath PolySwitch devices. It is possible that raised features could negatively impact solderability performance of our devices.

Rework

- Standard industry practices. (Please also avoid direct contact to the device.)

Part Ordering Number System

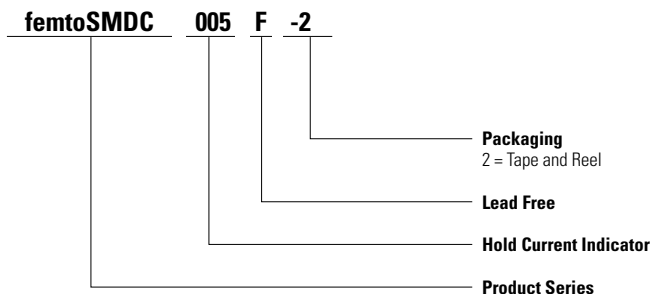

femtoSMDC Series

Surface Mount

Tape and Reel Specifications

Description	femtoSMDC EIA 481-1	
	femtoSMDC005F femtoSMDC008F femtoSMDC010F femtoSMDC035F	femtoSMDC012F femtoSMDC016F femtoSMDC020F
W	8.0 ± 0.30	8.0 ± 0.30
P ₀	4.0 ± 0.10	4.0 ± 0.10
P ₁	4.0 ± 0.10	4.0 ± 0.10
P ₂	2.0 ± 0.05	2.0 ± 0.05
A ₀	0.95 ± 0.05	0.95 ± 0.05
B ₀	1.85 ± 0.05	1.85 ± 0.05
B ₁ max	4.35	4.35
D ₀	1.55 ± 0.05	1.55 ± 0.05
F	3.50 ± 0.05	3.50 ± 0.05

Description	femtoSMDC EIA 481-1	
	femtoSMDC005F femtoSMDC008F femtoSMDC010F femtoSMDC035F	femtoSMDC012F femtoSMDC016F femtoSMDC020F
E ₁	1.75 ± 0.10	1.75 ± 0.10
E ₂ min	6.25	6.25
T max	0.3	0.3
T ₁ max	0.1	0.1
K ₀	0.90 ± 0.1	0.55 ± 0.05
A max	185	185
N min	50	50
W ₁	8.4 + 1.5/-0.00	8.4 + 1.5/-0.00
W ₂ max	14.4	14.4

Tape and Reel Diagrams

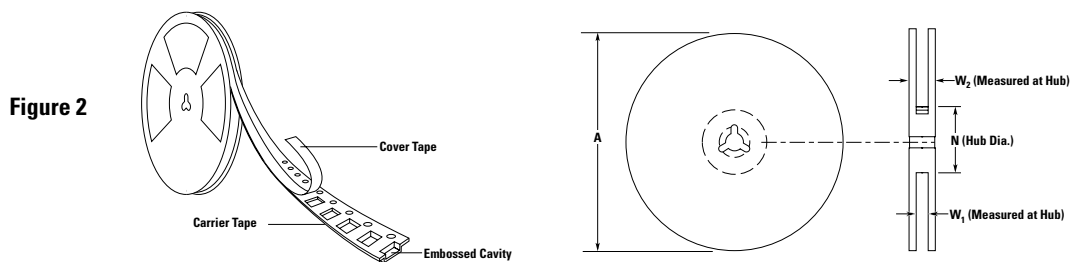
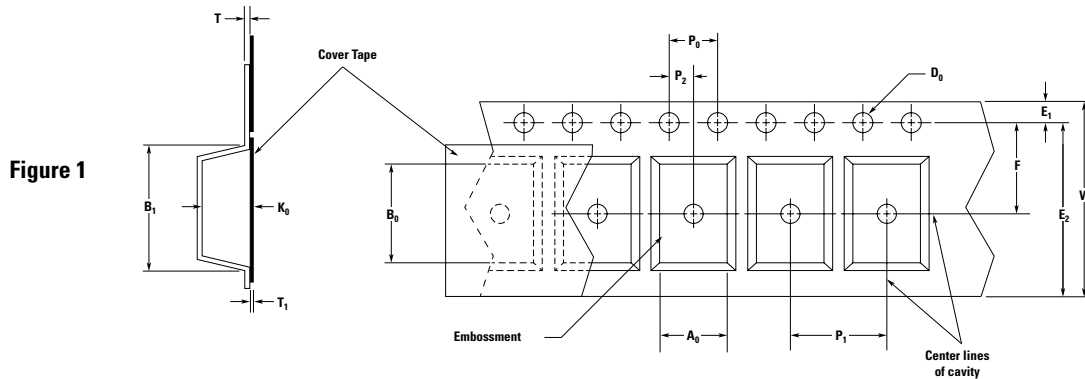

Warning

- Users should independently evaluate the suitability of and test each product selected for their own application.
- Operation beyond the maximum ratings or improper use may result in device damage and possible electrical arcing and flame.
- These devices are intended for protection against damage caused by occasional overcurrent or overtemperature fault conditions and should not be used when repeated fault conditions or prolonged trip events are anticipated.
- Contamination of the PPTC material with certain silicone-based oils or some aggressive solvents can adversely impact the performance of the devices.
- Device performance can be impacted negatively if devices are handled in a manner inconsistent with recommended electronic, thermal, and mechanical procedures for electronic components.
- PPTC devices are not recommended for installation in applications where the device is constrained such that its PTC properties are inhibited, for example in rigid potting materials or in rigid housings, which lack adequate clearance to accommodate device expansion.
- Operation in circuits with a large inductance can generate a circuit voltage (Ldi/dt) above the rated voltage of the device.

Disclaimer Notice - Information furnished is believed to be accurate and reliable. However, users should independently evaluate the suitability of and test each product selected for their own applications. Littelfuse products are not designed for, and may not be used in, all applications. Read complete Disclaimer Notice at www.littelfuse.com/disclaimer-electronics.