

DESCRIPTION

The MP4658 is a 4-string, secondary-side LED driver for LED backlighting, and is ideal for monitor and small-sized TV LED backlighting. It controls the flyback power stage to regulate the LED current loop and the output supply voltage. The MP4658 integrates 4-string LED current balancing. Powered by a 6V to 36V input supply voltage (V_{IN}), the MP4658 outputs a compensation signal to control the primary-side flyback (or other power stage) via an optocoupler to regulate the output voltage (V_{OUT}).

The MP4658 supports analog dimming and PWM dimming to the LED current through the ADIM and PDIM pins. For analog dimming, apply a pulse signal with a frequency above 5kHz to the ADIM pin. For PWM dimming, apply a low-frequency PWM signal to the PDIM pin. The MP4658 also supports analog mode PWM dimming to the LED current, which makes the LED current rise and fall softly.

The MP4658 features numerous smart protections to increase system reliability, including open LED protection, short LED string protection, LEDx short-to-ground protection, FB over-voltage protection (OVP), feedback open protection, and thermal protection. The MP4658 is available in an SOIC-16 package.

FEATURES

- 6V to 36V Supply Voltage (V_{IN})
- 80V/200mA, 4-String LED Current Balance
- Provides Feedback for the Previous Power Stage
- <2% LED Current Accuracy
- 1.5% LED Current Balance
- Low LEDx Regulation Voltage, High Efficiency
- Analog and PWM Dimming
- LED Open Protection, LED Short Protection
- LEDx Pin Short-to-GND Protection
- Over-Voltage Protection (OVP)
- Thermal Protection
- Available in an SOIC-16 Package

APPLICATIONS

- LCD Monitor and TVs
- Desktop LCD Flat Panel Displays
- Flat-Panel Video Displays

All MPS parts are lead-free, halogen-free, and adhere to the RoHS directive. For MPS green status, please visit the MPS website under Quality Assurance. "MPS", the MPS logo, and "Simple, Easy Solutions" are trademarks of Monolithic Power Systems, Inc. or its subsidiaries.

TYPICAL APPLICATION

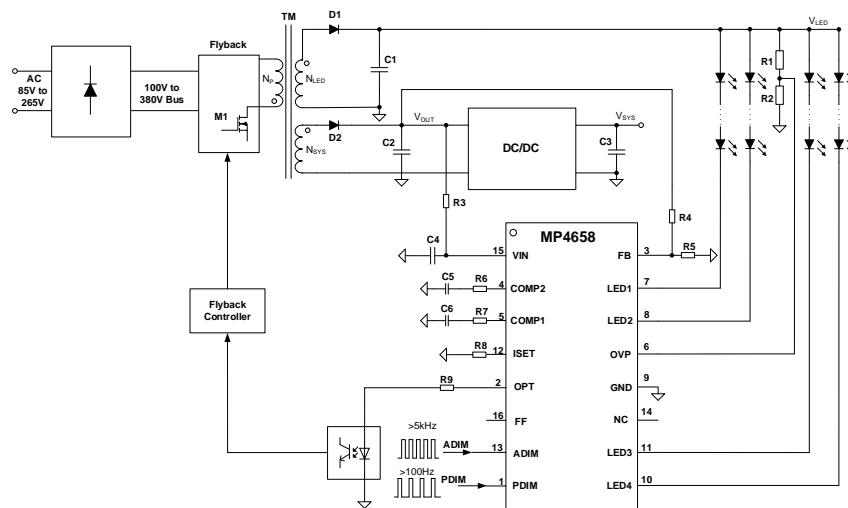

ORDERING INFORMATION

Part Number*	Package	Top Marking	MSL Rating
MP4658GS	SOIC-16	See Below	2

* For Tape & Reel, add suffix -Z (e.g. MP4658GS-Z).

TOP MARKING

MPSYYWW
MP4658
LLLLLLLLL

MPS: MPS prefix
 YY: Year code
 WW: Week code
 MP4658: Part number
 LLLLLLLLL: Lot number

PACKAGE REFERENCE

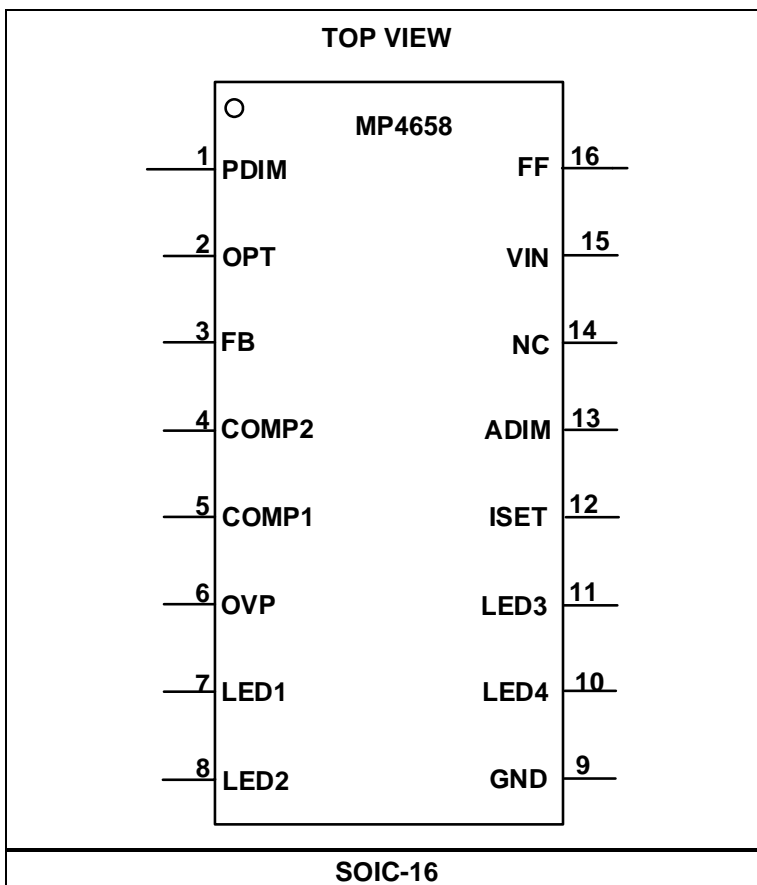

PIN FUNCTIONS

Pin #	Name	Description
1	PDIM	PWM dimming input pin. Connect a pulse signal to implement pulse-width modulation (PWM) dimming. When the PDIM pin's voltage remains low for 30ms, the LED stage is disabled and the IC enters constant voltage (CV) mode.
2	OPT	Optocoupler pin. This pin outputs the compensation signal for the primary-side flyback power stage. Connect this pin to the external optocoupler to control the flyback.
3	FB	System voltage feedback. Connect this pin to the system output through a voltage divider.
4	COMP2	Compensation pin. This pin compensates the output voltage (V_{OUT}) loop and controls the flyback power stage during the LED off period.
5	COMP1	Compensation pin. This pin compensates the LED current loop and controls the flyback power stage during the LED on period.
6	OVP	Over-voltage protection (OVP) pin. Connect this pin to the LED voltage (V_{LED}) output through a voltage divider.
7	LED1	Cathode of LED string 1.
8	LED2	Cathode of LED string 2.
9	GND	Ground.
10	LED4	Cathode of LED string 4.
11	LED3	Cathode of LED string 3.
12	ISSET	LED current set pin. This pin sets the LED current. Connect a resistor from this pin to the ground to set the LED current (I_{LED}).
13	ADIM	Analog dimming input pin. Connect a >5kHz PWM signal to implement analog dimming. The input impedance of this pin determines the internal filter constant, as well as the PWM dimming rise and fall times. When the ADIM pin's voltage remains low for 30ms, the LED stage is disabled and the IC enters CV mode.
14	NC	Not connected.
15	VIN	Input supply pin. This pin powers all internal logic circuitry.
16	FF	Fault indicator pin. If a fault occurs, this pin is pulled low.

ABSOLUTE MAXIMUM RATINGS ⁽¹⁾

VIN	-0.3V to +38V
LEDx.....	-0.3V to +80V
FF	-0.3V to +12V
Other pins.....	-0.3V to +6.5V
Junction temperature	150°C
Lead temperature	260°C
Continuous power dissipation ($T_A = 25^\circ\text{C}$) ⁽²⁾	1.56W
Storage temperature.....	-60°C to +150°C

ESD Ratings

Human body model (HBM)	±2000V
Charged device model (CDM).....	±750V

Recommended Operating Conditions ⁽³⁾

Supply voltage (V_{IN})	6V to 36V
Operating junction temp (T_J)	-40°C to +125°C

Thermal Resistance ⁽⁴⁾	θ_{JA}	θ_{JC}
SOIC-16.....	80	35... °C/W

Notes:

- Exceeding these ratings may damage the device.
- The maximum allowable power dissipation is a function of the maximum junction temperature T_J (MAX), the junction-to-ambient thermal resistance θ_{JA} , and the ambient temperature T_A . The maximum allowable continuous power dissipation at any ambient temperature is calculated by P_D (MAX) = $(T_J$ (MAX) - T_A) / θ_{JA} . Exceeding the maximum allowable power dissipation produces an excessive die temperature, causing the regulator to go into thermal shutdown. Internal thermal shutdown circuitry protects the device from permanent damage.
- The device is not guaranteed to function outside of its operating conditions.
- Measured on JESD51-7, 4-layer PCB.

ELECTRICAL CHARACTERISTICS

$V_{IN} = 12V$, $T_A = 25^\circ C$, unless otherwise noted.

Parameter	Symbol	Condition	Min	Typ	Max	Units
VIN Supply						
VIN supply range			6		36	V
VIN UVLO	V_{IN_UVLO}		4.5	4.79	5.5	V
VIN UVLO hysteresis	$V_{IN_HYS_UVLO}$			500		mV
Quiescent current	I_Q	PWM = ADIM = 0			0.5	mA
Analog Dimming						
ADIM logic high	V_{ADIM_HI}		1.5			V
ADIM logic low	V_{ADIM_LO}				0.4	V
ADIM/PWM pull-down resistor	R_{ADIM_DOWN}			1		M Ω
Analog dimming input frequency range			5 ⁽⁵⁾		100 ⁽⁵⁾	kHz
Duration to disable the ADIM pin	t_{ADIM_ST}			30		ms
ADIM pin input impedance for slow soft PWM dimming (3ms)			25		50	k Ω
ADIM pin input impedance for fast soft PWM dimming (700 μ s)					15	k Ω
PWM Dimming						
PDIM logic high	V_{PDIM_HI}		1.5			V
PDIM logic low	V_{PDIM_LO}				0.4	V
PDIM pull-down resistor	R_{PDIM_DOWN}			1		M Ω
PDIM input frequency range			100 ⁽⁵⁾			Hz
Duration to disable the PDIM pin	t_{PDIM_ST}			30		ms
OPT						
OPT pin output voltage range		Normal operation H		2.3		V
		Normal operation L		0.8		V
OPT pin output voltage when latched off				3.3		V
Source current capability	I_{OPT}			20		mA
VFB						
Reference voltage	V_{FB_REF}	PWM off	1.182	1.2	1.218	V
FB pull-down resistor	R_{FB_DOWN}			1		M Ω
VFB over-voltage protection (OVP)	V_{FB_OVP}			1.24		V_{REF_VFB}
System open feedback protection	V_{REF_OPEN}			500		mV
Compensation Loop for LED (COMP1)						
Gain bandwidth product	GB_{COMP1}	75pF on COMP1		1 ⁽⁵⁾		MHz
Open-loop DC gain	A_{V_COMP1}	COMP1 open		70 ⁽⁵⁾		dB
Input common-mode range	V_{CM_COMP1}	For design	-0.3 ⁽⁵⁾		+4 ⁽⁵⁾	V
Transconductance	G_{M_COMP1}	PWM = high		720		μ A/V

ELECTRICAL CHARACTERISTICS (continued)
 $V_{IN} = 12V$, $T_A = 25^\circ C$, unless otherwise noted.

Parameter	Symbol	Condition	Min	Typ	Max	Units
Saturated output current	I_{SAT_COMP1}			90		μA
Low-level clamp voltage	V_{COMP1_L}	Normal operation		1		V
High-level clamp voltage	V_{COMP1_H}	Normal operation		2.5		V
Compensation Loop for LED (COMP2)						
Gain bandwidth product	GB_COMP2	75pF on COMP2		1 ⁽⁵⁾		MHz
Open-loop DC gain	A_{V_COMP2}	COMP2 open		70 ⁽⁵⁾		dB
Low-level clamp voltage	V_{COMP2_L}	Normal operation		1		V
High-level clamp voltage	V_{COMP2_H}	Normal operation		2.5		V
Transconductance when PWM is off	G_{M_COMP2}	PWM off		260		$\mu A/V$
Saturated output current	I_{SAT_COMP2}			45		μA
LED Driver Protection (OVP, LED Open/Short)						
OVP threshold	V_{TH_OVP}			2.4		V
OVP threshold hysteresis				200		mV
OVP to latch IC threshold				3		V
LEDx threshold for open LED string mark-off		OVP triggered		100		mV
LEDx over-voltage (OV) threshold (for LED short protection)	V_{TH_LEDxOV}			5		V
LED short delay time	t_{D_LEDxOV}			5		ms
Thermal protection threshold				150 ⁽⁵⁾		$^\circ C$
Thermal protection hysteresis				25 ⁽⁵⁾		$^\circ C$
LED Current Regulation (V_{LEDx}, I_{SET})						
ISET voltage	V_{ISET}		1.53	1.58	1.63	V
LEDx average current	I_{LED}	$R_{ISET} = 320k\Omega$ (trim)	-1.5%	50	+1.5%	mA
		$R_{ISET} = 320k\Omega$ (40%)	-3%	20.3	+3%	mA
Current matching		$I_{LED} = 50mA$		0.3	2	%
		$R_{ISET} = 320k\Omega$, $I_{LED} = 20mA$ (40% of ADIM)		0.4	2.5	%
Minimum LEDx regulation voltage	V_{LEDx}	$I_{LED} = 200mA$		560		mV
		$I_{LED} = 1mA$		176		mV
FF pin pull-down resistor		Open drain		270		Ω

Note:

5) Guaranteed by design. Not tested in production.

TYPICAL PERFORMANCE CHARACTERISTICS

Reference Voltage vs. Temperature

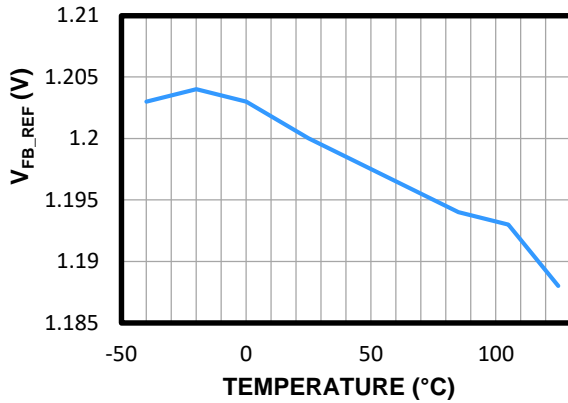

VFB OVP vs. Temperature

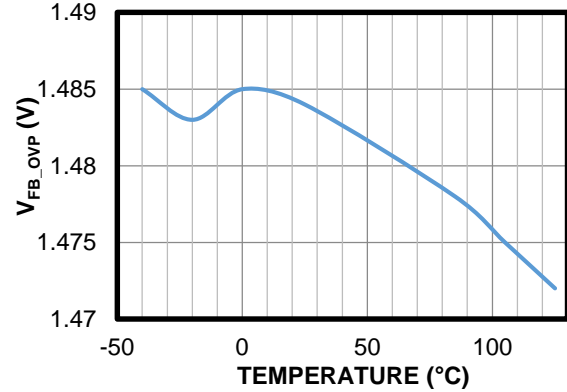

V_{IN} Rising Voltage vs. Temperature

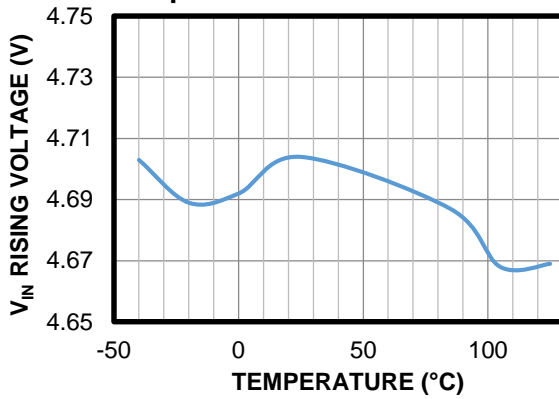

VLED OVP Threshold vs. Temperature

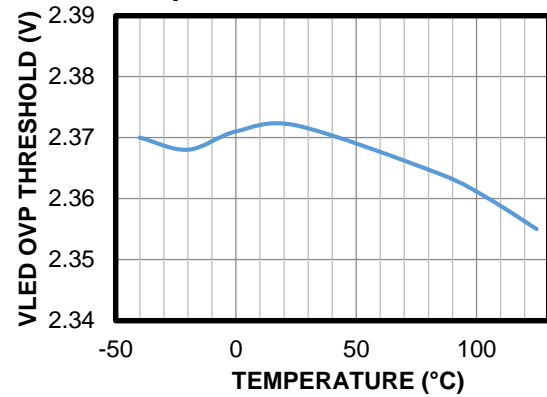

VFB Open Voltage vs. Temperature

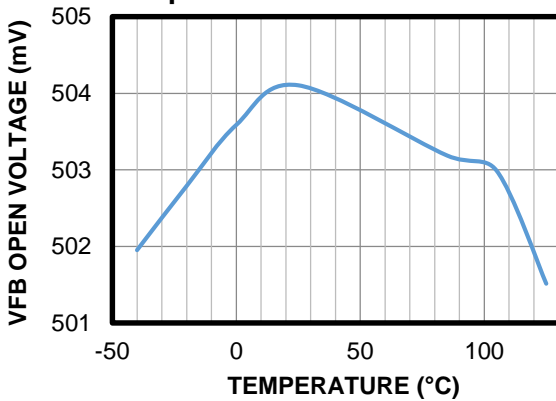

ISET Voltage vs. Temperature

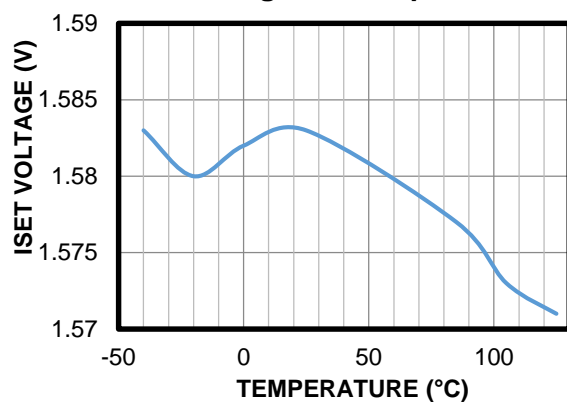

TYPICAL PERFORMANCE CHARACTERISTICS (continued)

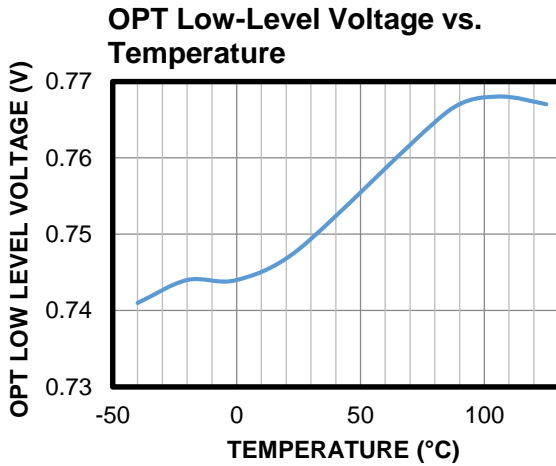
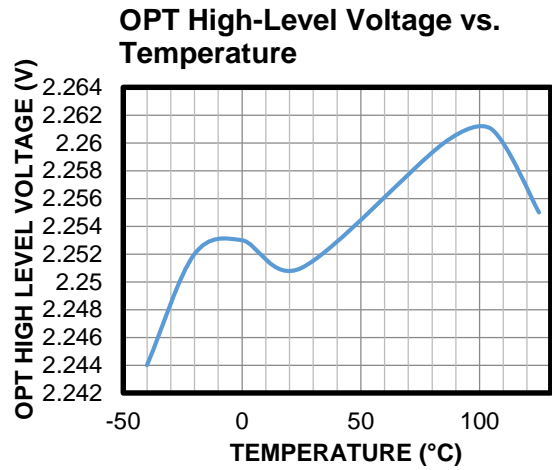
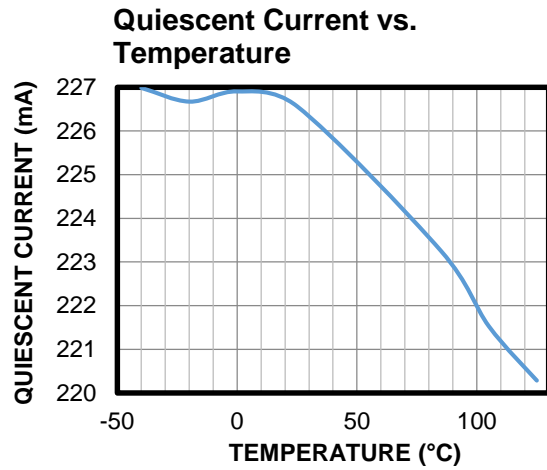

TYPICAL PERFORMANCE CHARACTERISTICS *(continued)*

$V_{IN_AC} = 220V_{AC}$, $V_{LED} = 40V$, $I_{LED} = 80mA/string$, $V_{SYS} = 5V$, $I_{SYS} = 3A$, $T_A = 25^{\circ}C$, unless otherwise noted.

Standby Mode

$V_{SYS} = 5V$, $I_{SYS} = 0.1A$

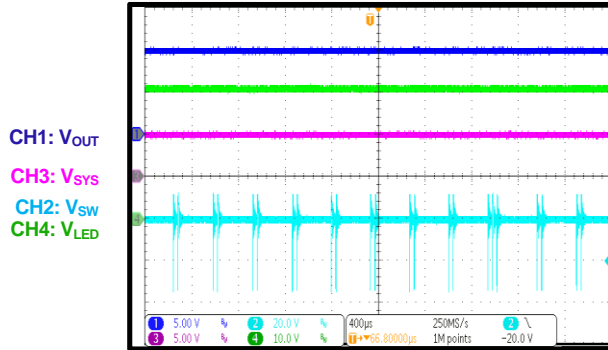

CV Mode

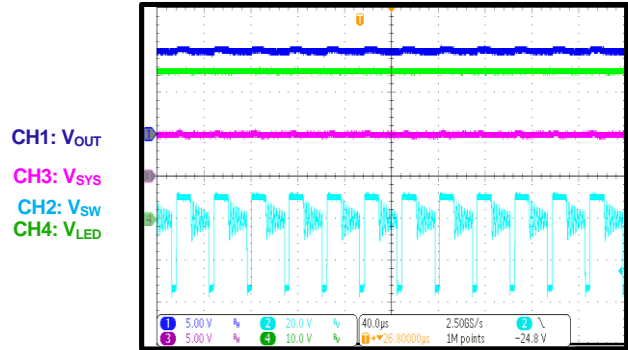

Power on in CV Mode

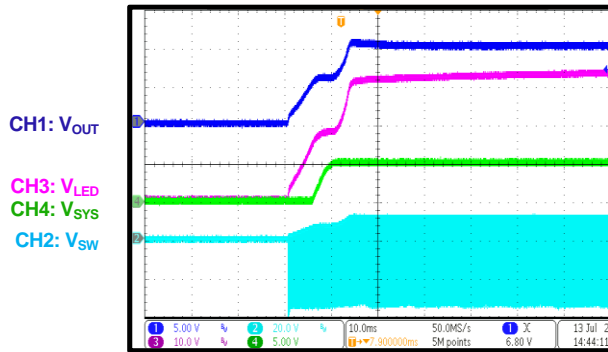

Power off in CV Mode

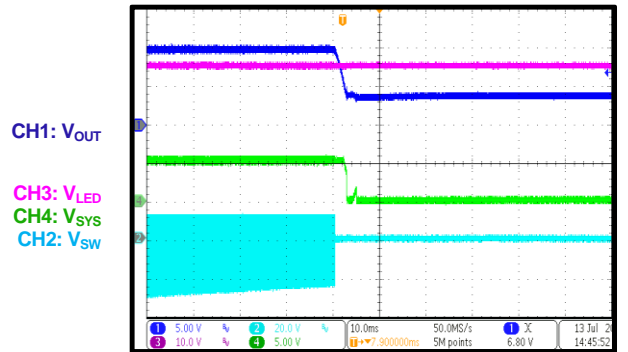

LED Enable

50% analog dimming

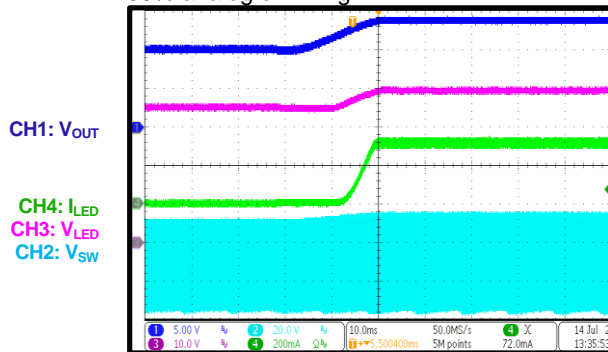

LED Disable

50% analog dimming

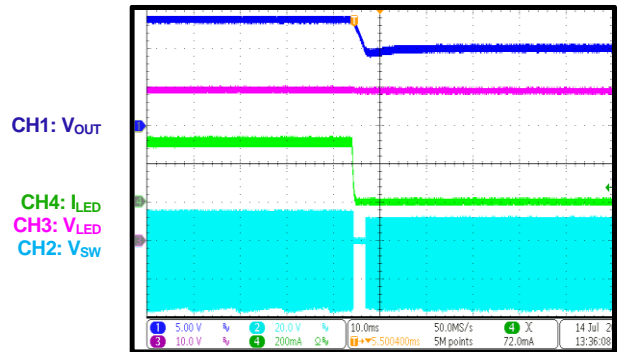

TYPICAL PERFORMANCE CHARACTERISTICS (continued)

$V_{IN_AC} = 220V_{AC}$, $V_{LED} = 40V$, $I_{LED} = 80mA/string$, $V_{SYS} = 5V$, $I_{SYS} = 3A$, $T_A = 25^{\circ}C$, unless otherwise noted.

Start-Up

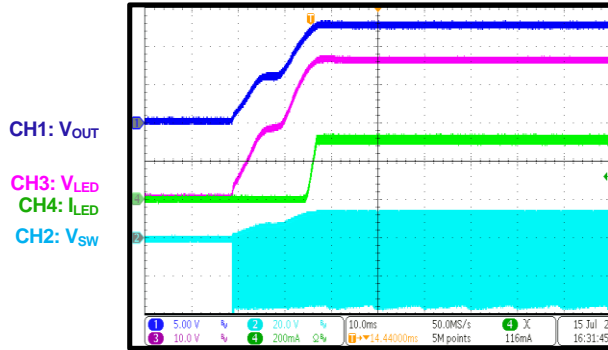

Shutdown

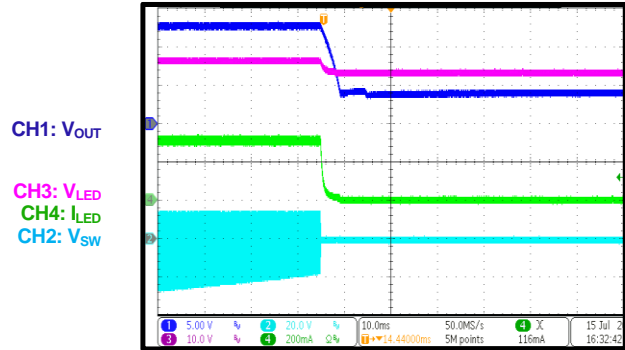

LED On
100% dimming

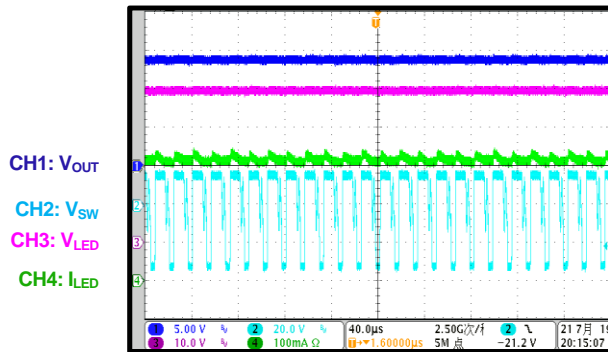

LED On
50% dimming

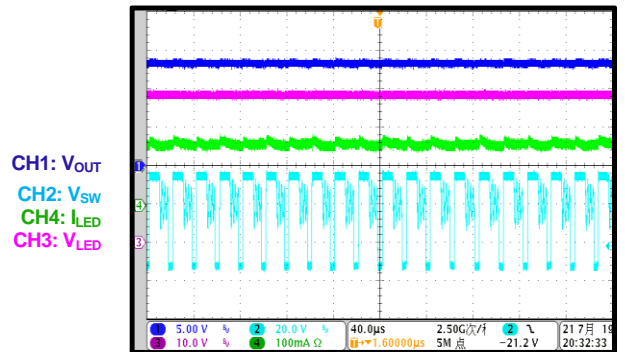

One String Short

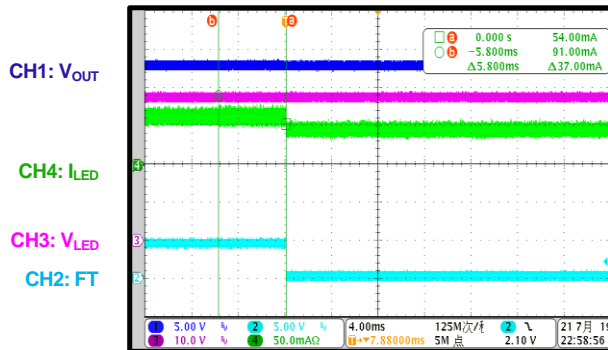

One String Open

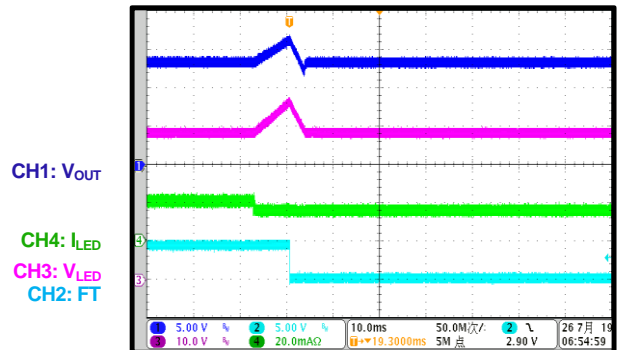

TYPICAL PERFORMANCE CHARACTERISTICS *(continued)*

$V_{IN_AC} = 220V_{AC}$, $V_{LED} = 40V$, $I_{LED} = 80mA/string$, $V_{SYS} = 5V$, $I_{SYS} = 3A$, $T_A = 25^{\circ}C$, unless otherwise noted.

Load Transient

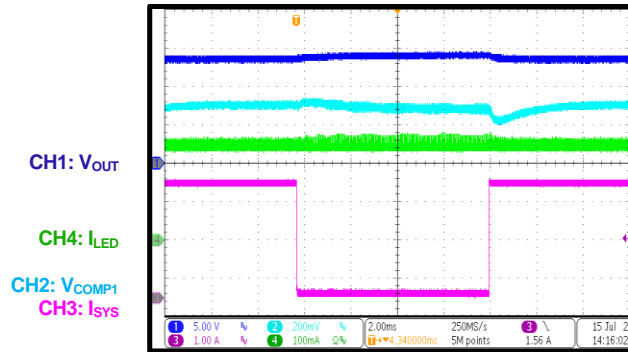

FUNCTIONAL BLOCK DIAGRAM

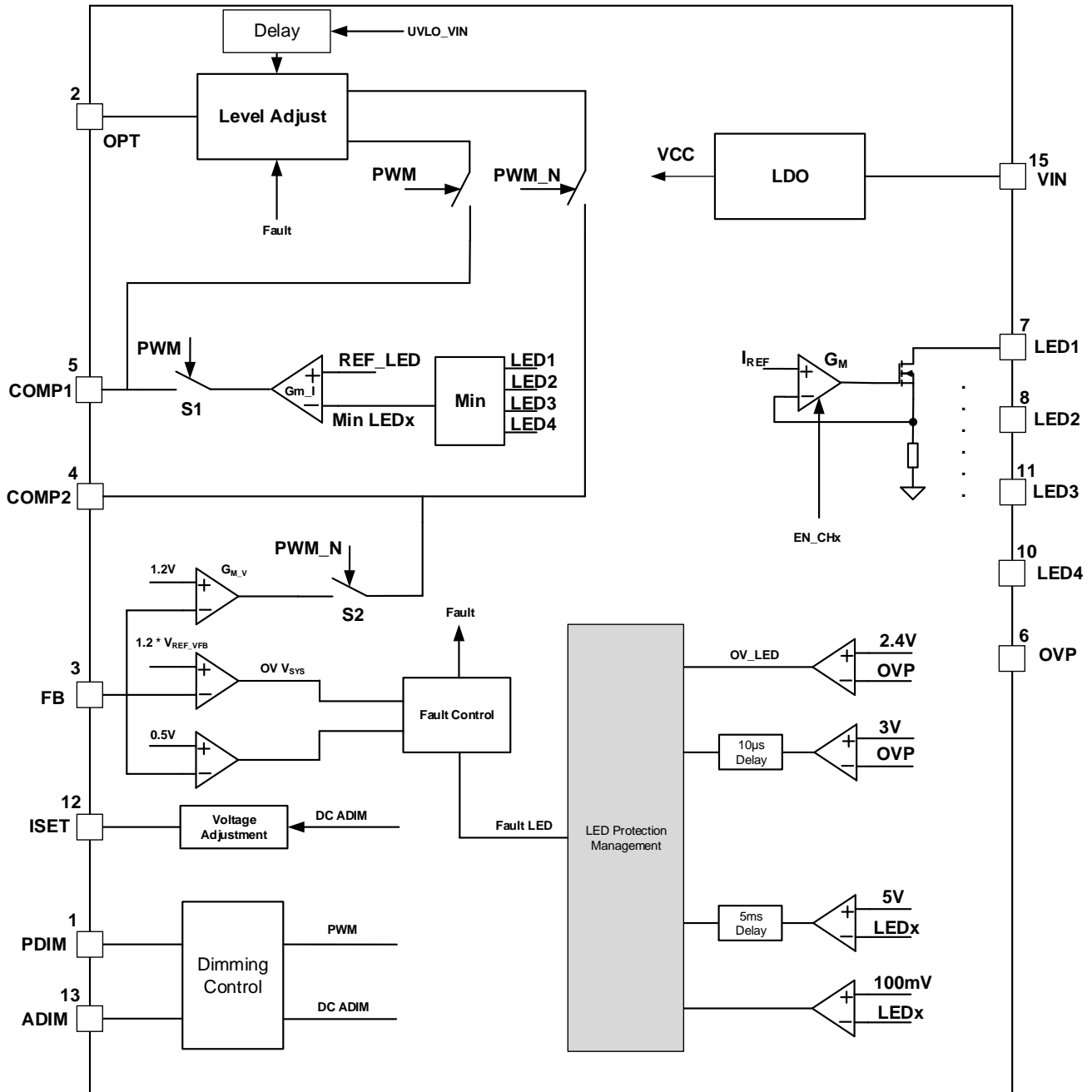

Figure 1: Functional Block Diagram

OPERATION

The MP4658 is a 4-string, secondary-side LED driver for LED backlighting, and is ideal for monitor and TV LED backlighting. It controls the flyback power stage to regulate the LED current (I_{LED}) loop during the PWM on time and regulate system supply voltage loop during the PWM off time. Powered by a 6V to 36V input voltage (V_{IN}) supply, the MP4658 outputs a compensation signal to control the primary-side flyback (or other power stage) through an optocoupler.

Start-Up

When the flyback is on, V_{IN} is charged until it reaches its UVLO threshold, at which point the system logic starts to work.

LED Current and Voltage Regulation

The MP4658 accurately regulates the I_{LED} loop or the output voltage (V_{OUT}) with a single flyback power stage.

When pulse-width modulation (PWM) dimming is on, the MP4658 regulates I_{LED} through the flyback power stage control (see Figure 2).

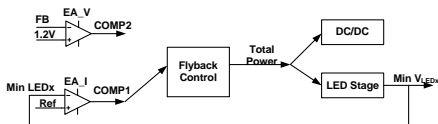

Figure 2: MP4658 Control Scheme when PWM Dimming Is On

When PWM dimming is off, the LED stage is disabled and the MP4658 regulates the output voltage (V_{OUT}) using the feedback (FB) voltage (V_{FB}) from the FB pin (see Figure 3).

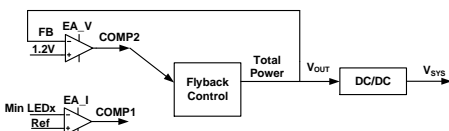

Figure 3: MP4658 Control Scheme when PWM Dimming Is Off

LED Current Regulation when PWM Dimming Is On

For the I_{LED} regulation loop, the minimum LEDx voltage (V_{LEDx}) is fed back and compared to the internal reference voltage. This reference changes with the I_{LED} setting. The internal error amplifier (EA) regulates the average minimum

V_{LEDx} to the internal reference voltage. The EA's output is connected to the external current-loop compensation network on the COMP1 pin through an inner switch (S1). During the PWM on time, S1 is on and the minimum V_{LEDx} is regulated by this control loop. The flyback power is set by the COMP1 voltage (V_{COMP1}). During the PWM off period, S1 is turned off, the compensation network is disconnected from the EA's output, and V_{COMP1} remains steady until the next PWM on interval. The EA's output is also pulled low during the PWM off period.

Output Voltage Regulation when PWM Dimming Is Off

When PWM dimming is off, the output voltage (V_{OUT}) is fed back to the FB pin and the internal V_{REF} is equal to 1.2V. During the PWM off period, the MP4658 regulates V_{OUT} by controlling the flyback power stage. The internal voltage-loop EA regulates the average V_{FB} to its internal reference. The EA's output is connected to the external voltage-loop compensation network on the COMP2 pin. The flyback power is set by the COMP2 voltage (V_{COMP2}).

When PWM dimming is on, the flyback power is controlled by V_{COMP1} and V_{OUT} varies with different dimming conditions. The voltage-loop EA's output is also pulled low.

Dimming Control

The MP4658 provides analog dimming and PWM dimming for I_{LED} through the separate ADIM and PDIM pin. For analog dimming, apply a pulse signal with a frequency above 5kHz to the ADIM pin and pull the PDIM pin high. The pulse signal's duty cycle sets the I_{LED} amplitude. For PWM dimming, the duty cycle of input signal at the ADIM pin sets the peak I_{LED} value. I_{LED} is chopped by the input PWM signal at the PDIM pin. The brightness of the LED string is proportional to the external PWM signal's duty cycle, which helps achieve fast and high-contrast ratio PWM dimming. For analog PWM dimming, apply a <5kHz pulse signal to the ADIM pin and pull the PDIM pin high. The ADIM pin's input impedance determines the internal analog dimming RC filter and the rising/falling speed during PWM dimming. If the input

impedance on ADIM is below 15k Ω , then the RC filter constant is smaller and the I_{LED} rising/falling speed during PWM dimming is faster. Soft PWM dimming for I_{LED} helps reduce the audible noise.

Protection Features

The MP4658 integrates sufficient protections for the output voltage stage and LED driver stage. The protections for the V_{OUT} stage includes system over-voltage protection (OVP) and open feedback loop protection. Fault protections for the LED driver stage include open LED protection, short LED string protection, one or more LED short protection and LEDx short to ground protection.

Output Over-Voltage Protection (OVP)

The FB pin senses V_{OUT} for regulation and OVP. If V_{FB} is 24% greater than V_{REF} , the MP4658 triggers output OVP and the OPT pin is clamped to 3.3V when the LED stage is off. Output OVP is disabled when the LED stage is on. The fault indicator outputs a low voltage when output OVP is triggered.

Feedback Open Protection

If V_{FB} is below 500mV, the IC latches off and the fault indicator outputs a low voltage.

Open LED Protection

The LED string voltage is sensed by the OVP pin. Open LED protection is achieved via the OVP pin voltage and the LEDx (LED1~4) pin voltage detections. If one or more LED strings are open, the respective V_{LEDx} is pulled to ground and the LED string's output voltage keeps increasing until the OVP pin's voltage (V_{OVP}) reaches the OVP threshold. When V_{OVP} reaches 2.4V and V_{LEDx} is below 100mV, the MP4658 triggers open LED protection. The IC marks off the open string(s), meaning any that have a V_{LEDx} below 100mV. The remaining LED strings discharge the output voltage and V_{OVP} decreases until it falls below the OVP threshold. Then the LED control loop recovers and the minimum V_{LEDx} of the remaining LED strings is regulated. If an LED open fault is triggered, the fault indicator pin outputs a low voltage.

If all LED strings are open, all strings are marked off and the LED control loop is disabled. If an open all LED strings condition occurs, the IC operation mode switches from constant current (CC) mode to constant voltage (CV) mode.

If V_{OVP} exceeds 3V, the IC latches off. This function protects the components from any out of control condition (such as the LED output voltage exceeding V_{OV_LED} when the OPT pin is not pulled high) and keeps the system safe.

LED Short Protection

V_{LEDx} is used to indicate a short LED condition. If an LED string is shorted, the respective V_{LEDx} increases significantly. If V_{LEDx} exceeds 5V for 5ms, a short fault is triggered, and the MP4658 marks off this string. Other strings keep working if they are not experiencing a short.

If short protection is triggered, the fault indicator outputs a low voltage.

LEDx Short-to-Ground Protection

If COMP1 is saturated and V_{LEDx} is low for 30ms, the IC triggers LEDx short-to-ground protection. The LED control loop is disabled, and the output voltage is regulated in constant voltage (CV) mode. If this protection is triggered, the fault indicator outputs a low voltage.

The LED loop can recover from a fault condition by toggling the ADIM or PDIM pin. Pull either pin low for more than 30ms, then pull it high. The fault condition should be removed, and the fault indicator should reset.

Thermal Protection

Thermal protection is integrated in the MP4658. If the die temperature exceeds the over-temperature (OT) threshold (150°C), the IC stops working until the die temperature falls to 125°C.

APPLICATION INFORMATION

Open LED Protection (OVP)

The OVP pin monitors the LED output voltage and controls open LED protection. Connect this pin to the LED output voltage through a voltage divider, and set the OVP point using Equation (1):

$$V_{OV_LED} = \frac{2.4V \times (R_{OVPH} + R_{OVPL})}{R_{OVPL}} \quad (1)$$

Where R_{OVPH} and R_{OVPL} are the high-side and low-side resistors of the voltage divider, respectively.

Output Voltage Feedback (FB)

The FB pin feeds back the output voltage (V_{OUT}). Connect this pin to the output voltage through a voltage divider. This voltage divider determines V_{OUT} , which can be calculated with Equation (2):

$$V_{OUT} = \frac{1.2V \times (R_{VFBH} + R_{VFBL})}{R_{VFBL}} \quad (2)$$

Where R_{VFBH} and R_{VFBL} are the high-side and low-side resistors of the voltage divider, respectively.

LED Current Setting

The LED current (I_{LED}) is set by the resistor on the ISET pin. The ISET pin outputs a 1.6V voltage and its sourcing current determines I_{LED} . Estimate I_{LED} with Equation (3):

$$I_{LED} (mA) = \frac{80k\Omega \times 200mA}{R_{ISET} (k\Omega)} \quad (3)$$

Selecting the Turn Ratios of the Power Transformer

The power transformer includes three power windings: the primary-side winding, the LED secondary-side winding and the output voltage winding. Follow these steps to design the turn ratios of the power transformer:

Design the turn ratio between the primary-side winding and LED secondary-side winding using $N_P:N_{LED}$. The maximum voltage stress on the primary-side switch occurs at the maximum input AC voltage and maximum output LED voltage.

Calculate the maximum voltage stress on the primary-side switch (V_{DS_PRI}) with Equation (4):

$$V_{DS_PRI} = 1.414 \times V_{IN_AC_MAX} + (V_{OV_LED} + V_{DIODE}) \times \frac{N_P}{N_{LED}} \quad (4)$$

Considering the leakage inductance of the flyback transformer, assume a 60V spike voltage on the primary-side switch and a 10% derating of the switch voltage capability. Calculate the primary-side switch's rating voltage with Equation (5):

$$V_{DS_PRI} + 60 \leq 0.9 \times V_{RATING_PRI} \quad (5)$$

Calculate the turn ratio ($N_P:N_{LED}$) between the primary-side winding (N_P) and the secondary LED winding (N_{LED}) with Equation (6):

$$N_P:N_{LED} = \frac{(0.9 \times V_{RATING_PRI} - 60V - 1.414 \times V_{IN_AC_MAX})}{V_{OV_LED} + V_{DIODE}} \quad (6)$$

Where V_{RATING_PRI} is the rating voltage of the primary-side switch, $V_{IN_AC_MAX}$ is the maximum input AC voltage, V_{DIODE} is the forward voltage of the rectifier diode, and V_{OV_LED} is the OVP point of the LED output voltage.

Design the turn ratio between the LED winding and the output voltage winding: $N_{LED}:N_{SYS}$. When the LED stage is working, the LED winding voltage (V_{LED}) clamps the system winding voltage via the turn ratio. Ensure that V_{OUT} exceeds the voltage set with Equation (2) when the LED stage is on with the minimum V_{LED} . Estimate this relationship with Equation (7):

$$V_{OUT} + V_{DIODE} \leq \frac{V_{LED_MIN} + V_{DIODE}}{\frac{N_{LED}}{N_{SYS}}} \quad (7)$$

Where V_{LED_MIN} is the minimum LED output voltage. Choose a 10% margin for production design, calculated with Equation (8):

$$N_{LED}:N_{SYS} \leq \frac{0.9 \times (V_{LED_MIN} + V_{DIODE})}{V_{OUT} + V_{DIODE}} \quad (8)$$

PCB Layout Guidelines

Efficient PCB layout is important to achieve reliable operation, good EMI performance and excellent thermal performance. For the best results, refer to Figure 4 and follow the guidelines below:

1. Minimize the area of the power stage loop. This includes the primary loop (input capacitor, transformer, and MOSFET sense resistor), as well as the secondary-side winding loop (transformer, rectifier, and output capacitor).
2. Separate the output loop GND and control circuit GND, and only connect them at the GND pin.
3. Place the peripheral electronic components (such as those for VIN, FB, COMP1, and COMP2) as close to the IC as possible to decouple noise.

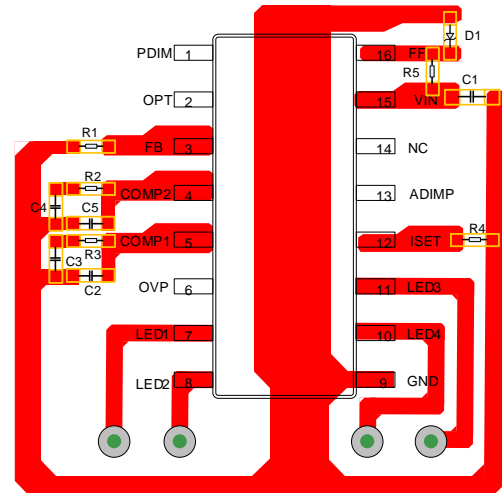

Figure 4: Recommended PCB Layout

TYPICAL APPLICATION CIRCUIT

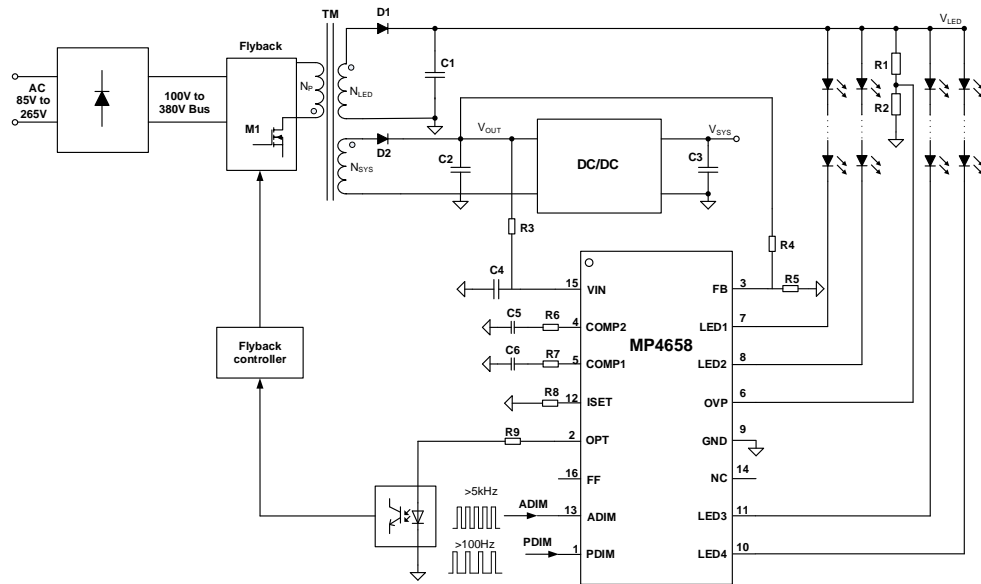
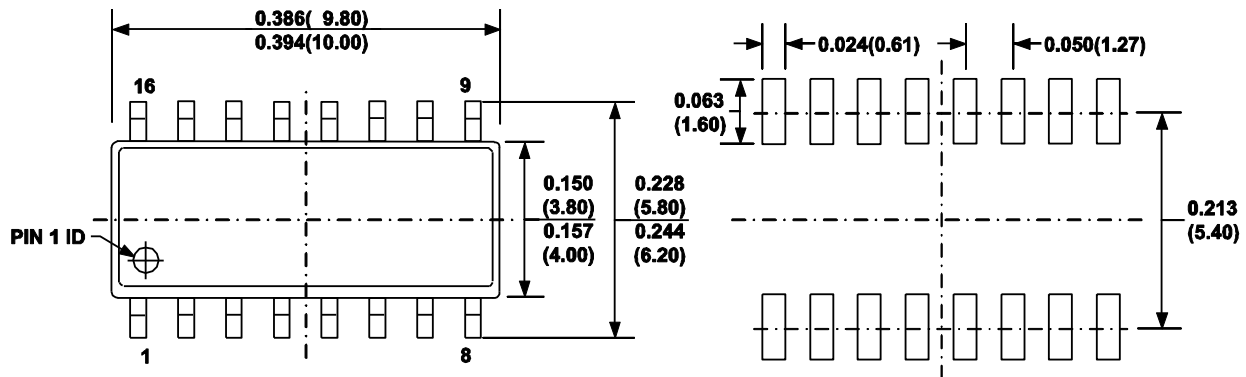

Figure 5: MP4658 Typical Application Circuit (Flyback 4-String LED Driver)

PACKAGE INFORMATION

SOIC-16



TOP VIEW

RECOMMENDED LAND PATTERN

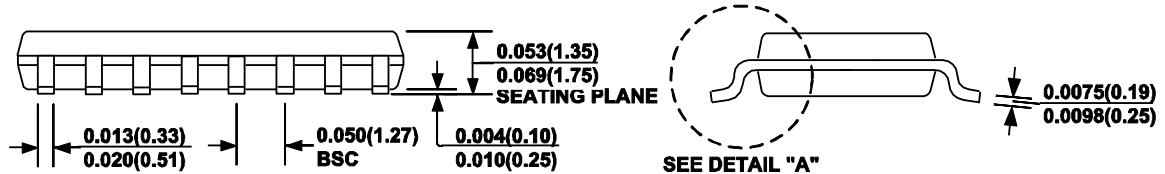

FRONT VIEW

SIDE VIEW

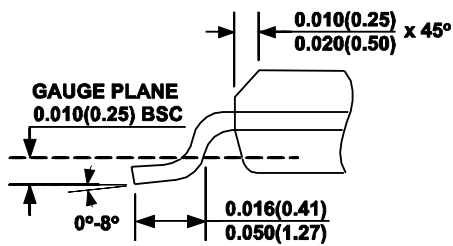

DETAIL "A"

NOTE:

- 1) CONTROL DIMENSION IS IN INCHES. DIMENSION IN BRACKET IS IN MILLIMETERS.
- 2) PACKAGE LENGTH DOES NOT INCLUDE MOLD FLASH, PROTRUSIONS OR GATE BURRS.
- 3) PACKAGE WIDTH DOES NOT INCLUDE INTERLEAD FLASH OR PROTRUSIONS.
- 4) LEAD COPLANARITY (BOTTOM OF LEADS AFTER FORMING) SHALL BE 0.004" INCHES MAX.
- 5) DRAWING CONFORMS TO JEDEC MS-012, VARIATION AC.
- 6) DRAWING IS NOT TO SCALE.

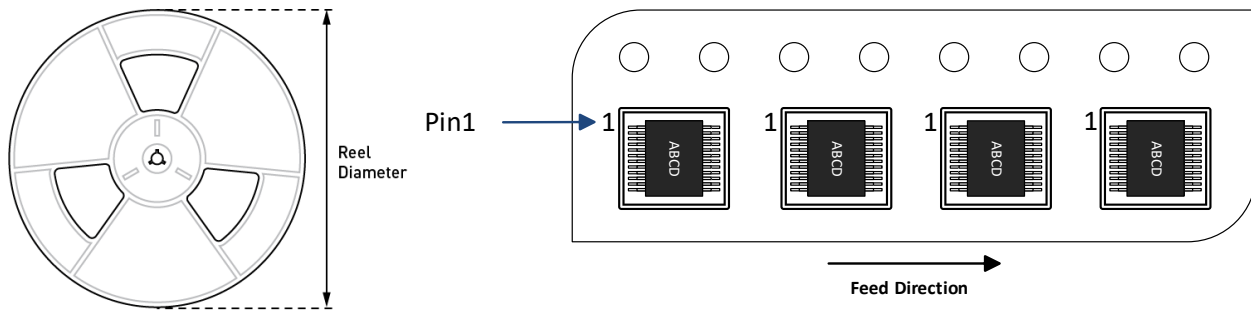
CARRIER INFORMATION

Part Number	Package Description	Quantity/ Reel	Quantity/ Tube	Quantity/ Tray	Reel Diameter	Carrier Tape Width	Carrier Tape Pitch
MP4658GS-Z	SOIC-16	2500	50	N/A	13in	16mm	8mm

REVISION HISTORY

Revision #	Revision Date	Description	Pages Updated
1.0	10/13/2021	Initial Release	-

Notice: The information in this document is subject to change without notice. Please contact MPS for current specifications. Users should warrant and guarantee that third-party Intellectual Property rights are not infringed upon when integrating MPS products into any application. MPS will not assume any legal responsibility for any said applications.