



# RZT7-03ZRS-KQ0

RZT7

SENSORS FOR T-SLOT CYLINDERS

**SICK**  
Sensor Intelligence.



### Ordering information

Type	Part no.
RZT7-03ZRS-KQ0	1070849

Other models and accessories → [www.sick.com/RZT7](http://www.sick.com/RZT7)



### Detailed technical data

#### Features

<b>Cylinder type</b>	T-slot
<b>Cylinder types with adapter</b>	Profile cylinder Tie rod cylinder Round body cylinder Dovetail groove cylinder SMC rail CDQ2 SMC rail ECDQ2
<b>Housing length</b>	29.5 mm
<b>Switching output</b>	Reed
<b>Switching frequency</b>	400 Hz
<b>Output function</b>	NO
<b>Electrical wiring</b>	AC/DC 3-wire
<b>Enclosure rating</b>	IP65 <sup>1)</sup> IP67

<sup>1)</sup> According to EN 60529.

#### Mechanics/electronics

<b>Supply voltage</b>	5 V AC/DC ... 30 V AC/DC
<b>Voltage drop</b>	≤ 0.1 V <sup>1)</sup>
<b>Continuous current I<sub>a</sub></b>	≤ 500 mA <sup>2)</sup> ≤ 300 mA <sup>3)</sup>
<b>Switching capacity</b>	≤ 6 W
<b>Protection class</b>	III
<b>Response sensitivity, typ.</b>	3 mT
<b>Overrun distance, typ.</b>	10 mm
<b>Reproducibility</b>	≤ 0.1 mT <sup>4)</sup>

<sup>1)</sup> For cable length up to 0.3 m.

<sup>2)</sup> DC.

<sup>3)</sup> AC.

<sup>4)</sup> U<sub>b</sub> and T<sub>a</sub> constant.

<b>Status indicator LED</b>	✓
<b>Reverse polarity protection</b>	✓
<b>Ambient operating temperature</b>	-30 °C ... +80 °C
<b>Shock and vibration resistance</b>	30 g, 11 ms / 10 ... 55 Hz, 1 mm
<b>EMC</b>	According to EN 60947-5-2
<b>Connection type</b>	Cable with connector M12, 3-pin, with knurled nuts, drag chain use, 0.3 m
<b>Connection type Detail</b>	
Conductor cross-section	0.14 mm <sup>2</sup>
Cable diameter	Ø 2.9 mm
Bending radius	With fixed installation > 8 x cable diameter For flexible use > 12 x cable diameter
Cable outlet	Axial
<b>Material</b>	
Housing	Plastic
Cable	PUR
<b>UL File No.</b>	NRKH.E181493 & NRKH7.E181493

<sup>1)</sup> For cable length up to 0.3 m.

<sup>2)</sup> DC.

<sup>3)</sup> AC.

<sup>4)</sup> Ub and Ta constant.

### Safety-related parameters

<b>MTTF<sub>D</sub></b>	41,230 years
<b>DC<sub>avg</sub></b>	0 %
<b>T<sub>M</sub> (mission time)</b>	20 years
<b>B<sub>10d</sub></b>	10,000,000 Switching cycles <sup>1)</sup>

<sup>1)</sup> Only for devices containing electro-mechanical components. In this case, the MTTFD value of the entire device must be calculated from the given B10D value, the number of switching cycles and the given MTTFD value.

### Classifications

<b>ECl@ss 5.0</b>	27270104
<b>ECl@ss 5.1.4</b>	27270104
<b>ECl@ss 6.0</b>	27270104
<b>ECl@ss 6.2</b>	27270104
<b>ECl@ss 7.0</b>	27270104
<b>ECl@ss 8.0</b>	27270104
<b>ECl@ss 8.1</b>	27270104
<b>ECl@ss 9.0</b>	27270104
<b>ECl@ss 10.0</b>	27270104
<b>ECl@ss 11.0</b>	27270104
<b>ECl@ss 12.0</b>	27274301
<b>ETIM 5.0</b>	EC002544
<b>ETIM 6.0</b>	EC002544
<b>ETIM 7.0</b>	EC002544

<b>ETIM 8.0</b>	EC002544
<b>UNSPSC 16.0901</b>	39122230

### Installation note

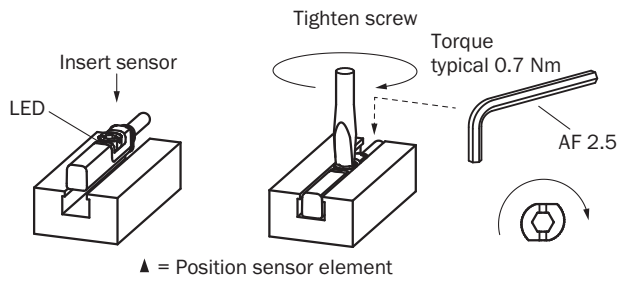

### Connection diagram

Cd-036

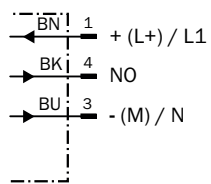

**Dimensional drawing** (Dimensions in mm (inch))

Cable with connector M12, with knurled nuts

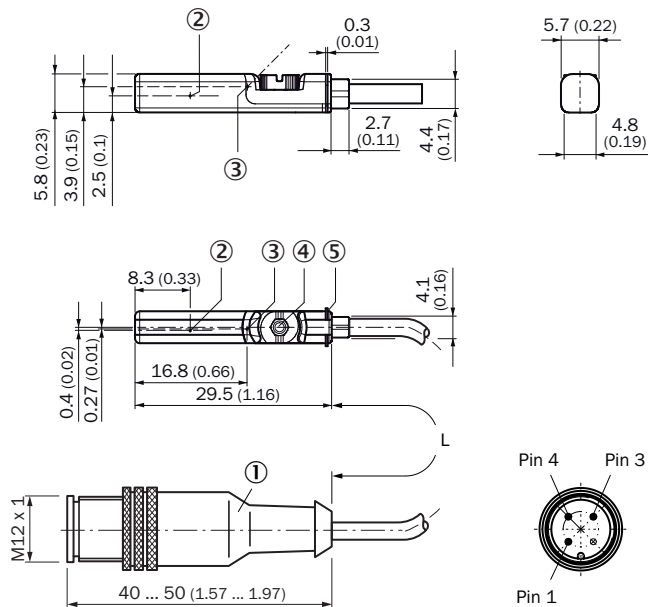





- ① Connection
- ② Position sensor element
- ③ Display LED
- ④ Fixing screw SW 2.5
- ⑤ Retaining ribs

Part no.	Type	L	Number of cores	Supply voltage
1070859	RZT7-03ZUS-KQ0	300 mm	2	5 V AC/DC ... 30 V AC/DC
1070849	RZT7-03ZRS-KQ0	300 mm	3	5 V AC/DC ... 30 V AC/DC

**Recommended accessories**

Other models and accessories → [www.sick.com/RZT7](http://www.sick.com/RZT7)

	Brief description	Type	Part no.
<b>Brackets for cylinder sensors</b>			
	Mounting bracket for cylinder with dovetail slot, Aluminum, without mounting hardware	BEF-KHZ-ST1	2022703
	Mounting bracket for integrated profile cylinder/tie-rod cylinder, zinc diecast, mounting hardware included	BEF-KHZ-PT1	2022702
	1 piece, Mounting bracket on round body cylinder with piston diameter of 12 mm, ambient temperature min 0 °C max 50 °C, plastic, Aluminum	BEF-KHZ-RT-12	2077681
	1 piece, Mounting bracket on round body cylinder with piston diameter of 16 mm, ambient temperature min 0 °C max 50 °C, plastic, Aluminum	BEF-KHZ-RT-16	2077680
	1 piece, Mounting bracket on round body cylinder with piston diameter of 20 mm, ambient temperature min 0 °C max 50 °C, plastic, Aluminum	BEF-KHZ-RT-20	2077679
	1 piece, Mounting bracket on round body cylinder with piston diameter of 25 mm, ambient temperature min 0 °C max 50 °C, plastic, Aluminum	BEF-KHZ-RT-25	2077678

	<b>Brief description</b>	<b>Type</b>	<b>Part no.</b>
	1 piece, Mounting bracket on round body cylinder with piston diameter of 32 mm, ambient temperature min 0 °C max 50 °C, plastic, Aluminum	BEF-KHZ-RT-32	2077677
	1 piece, Mounting bracket on round body cylinder with piston diameter of 40 mm, ambient temperature min 0 °C max 50 °C, plastic, Aluminum	BEF-KHZ-RT-40	2077676
	1 piece, Mounting bracket on round body cylinder with piston diameter of 50 mm, ambient temperature min 0 °C max 50 °C, plastic, Aluminum	BEF-KHZ-RT-50	2077675
	1 piece, Mounting bracket on round body cylinder with piston diameter of 63 mm, ambient temperature min 0 °C max 50 °C, plastic, Aluminum	BEF-KHZ-RT-63	2077674
	1 piece, Mounting bracket on round body cylinder with piston diameter of 8 mm ... 130 mm, ambient temperature min -30 °C max 80 °C, stainless steel, Zinc cast	BEF-KHZ-RT1-130	2077684
	1 piece, Mounting bracket on round body cylinder with piston diameter of 8 mm ... 25 mm, ambient temperature min -30 °C max 80 °C, stainless steel, Zinc cast	BEF-KHZ-RT1-25	2077682
	1 piece, Mounting bracket on round body cylinder with piston diameter of 8 mm ... 63 mm, ambient temperature min -30 °C max 80 °C, stainless steel, Zinc cast	BEF-KHZ-RT1-63	2077683
	Mounting bracket for mounting on SMC rails CDQ2 (T-slot), Aluminum, without mounting hardware	BEF-KHZ-TT2	2046440
	Mounting bracket for mounting on SMC rails ECDQ2 (T-slot), Aluminum, without mounting hardware	BEF-KHZ-TT1	2046439
<b>Device protection (mechanical)</b>			
	Protective adapter, die-cast zinc, mounting hardware included	BEF-SG-MRZT	2077201
<b>Plug connectors and cables</b>			
	Head A: female connector, M12, 3-pin, straight, A-coded Head B: Flying leads Cable: Sensor/actuator cable, PUR, halogen-free, unshielded, 2 m	YF2A13-020UB1XLEAX	2095604
	Head A: female connector, M12, 3-pin, straight, A-coded Head B: Flying leads Cable: Sensor/actuator cable, PUR, halogen-free, unshielded, 5 m	YF2A13-050UB1XLEAX	2095605
	Head A: female connector, M12, 3-pin, angled, A-coded Head B: Flying leads Cable: Sensor/actuator cable, PUR, halogen-free, unshielded, 2 m	YG2A13-020UB1XLEAX	2095752
	Head A: female connector, M12, 3-pin, angled, A-coded Head B: Flying leads Cable: Sensor/actuator cable, PUR, halogen-free, unshielded, 5 m	YG2A13-050UB1XLEAX	2095753

## SICK AT A GLANCE

SICK is one of the leading manufacturers of intelligent sensors and sensor solutions for industrial applications. A unique range of products and services creates the perfect basis for controlling processes securely and efficiently, protecting individuals from accidents and preventing damage to the environment.

We have extensive experience in a wide range of industries and understand their processes and requirements. With intelligent sensors, we can deliver exactly what our customers need. In application centers in Europe, Asia and North America, system solutions are tested and optimized in accordance with customer specifications. All this makes us a reliable supplier and development partner.

Comprehensive services complete our offering: SICK LifeTime Services provide support throughout the machine life cycle and ensure safety and productivity.

For us, that is “Sensor Intelligence.”

## WORLDWIDE PRESENCE:

Contacts and other locations –[www.sick.com](http://www.sick.com)