

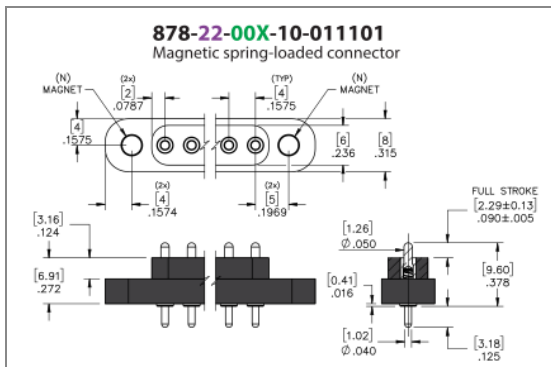

PRODUCT NUMBER: 878-22-002-10-011101

www.mill-max.com
DATA SHEET



878-22-002-10-011101- SPECIFICATIONS

General Info	
Description¹:	PCB Mount Spring-Loaded Header Magnetic Vertical Mount Through-Hole
Type:	Spring-Loaded
Category:	Maxnetic™ Spring-Loaded Header
Mounting Style:	Mounting Tabs with Magnetic Inserts
# Pins:	2
Packaging:	Packaged in Tubes
Pitch:	.158" (4,001mm)
Rows:	Single Row
Product Lifecycle:	Active

Environmental Specs	
Temperature Range:	-55/+80° C
Shock²:	No Elect. Discontinuity > 1µs @ 50g
Vibration²:	No Elect. Discontinuity > 1µs @ 10-2000HZ, 15 G
RoHS³:	Yes

Mechanical Specs	
Durability:	100,000 to 1,000,000 Cycles @ Mid-Stroke

Materials	
Shell Plating:	20µ" Gold over Nickel
Inner Plating:	(Spring) 10µ" Gold
Insulator Material:	Nylon 4/6

Technical Specs	
Initial Height:	.378" (9,601mm)
Stroke:	.090" (2,286mm)

Electrical Specs	
Rated Voltage:	100 VRMS/150 VDC
Insulation Resistance:	10,000 MΩ min.
Dielectric Withstanding Voltage:	1,000 VRMS min.

NOTES:

1. Standard Tolerances

Assembly tolerance: +/- .010" (.25mm)

Connector Length "L"

Connector Length "L"	Tolerance
$L \leq 2"$ ($L \leq 50.8$ mm)	+/- .005" (+/- .127 mm)
$2 < L \leq 3"$ ($50.8 < L \leq 76.2$ mm)	+ .007 / - .006" (+ .178 / - .152 mm)
$3 < L \leq 4"$ ($76.2 < L \leq 101.6$ mm)	+ .009 / - .007" (+ .229 / - .178 mm)
$4 < L \leq 5"$ ($101.6 < L \leq 127$ mm)	+ .011 / - .008" (+ .279 / - .203 mm)
$5 < L \leq 6.4"$ ($127 < L \leq 162.56$ mm)	+ .013 / - .009" (+ .330 / - .229 mm)

Insulator width: +/- .005 (.13mm)

Insulator height: +/- .005 (.13mm)

Co-planarity of SMT connectors: .005" (.13mm) up to 1" (25.4mm) in connector length

Insulator Flatness: .005" (.13mm) up to 1" (25.4mm) in connector length

Pin Length: +/- .006 (.15mm)

Pin Diameter: +/- .002 (.051mm)

Pin Angle: +/- 2°

2. For discrete pin only. Per IEC 60512-6-3: Test 6c: Shock

3. Mill-Max products labeled with the RoHS symbol are compliant with all three ROHS Directives. All of our products previously described as RoHS (2002/95/EC) and RoHS-2 (2011/65/EC) are also compliant with RoHS-3 (2015/863/EU).

ADDITIONAL NOTES AND SPECIFICATIONS

In the interest of improved design, quality and performance, Mill-Max reserves the right to make changes in its specifications without prior notice. Specifications and tolerances are provided wherever possible. The tolerance on dimensions of critical to function features is typically held tighter than the stated standard tolerances, such as press-fits, holes and lengths affecting the coplanarity of SMT products. Due to the wide variety of interconnects Mill-Max offers, the specific tolerances vary from product to product. If you need information regarding the tolerance of a particular part, please contact Technical Services.

RELATED LINKS AND DOCUMENTS

Engineering Notebook: (<https://www.mill-max.com/engineering-notebooks/introduction-to-spring-loaded-pogo-pins-connectors>)

Environmental Compliance: (<https://www.mill-max.com/rohs>)