

# Cable Glands

Waterproof, Dustproof and Breathable

**multicomp** PRO

RoHS  
Compliant

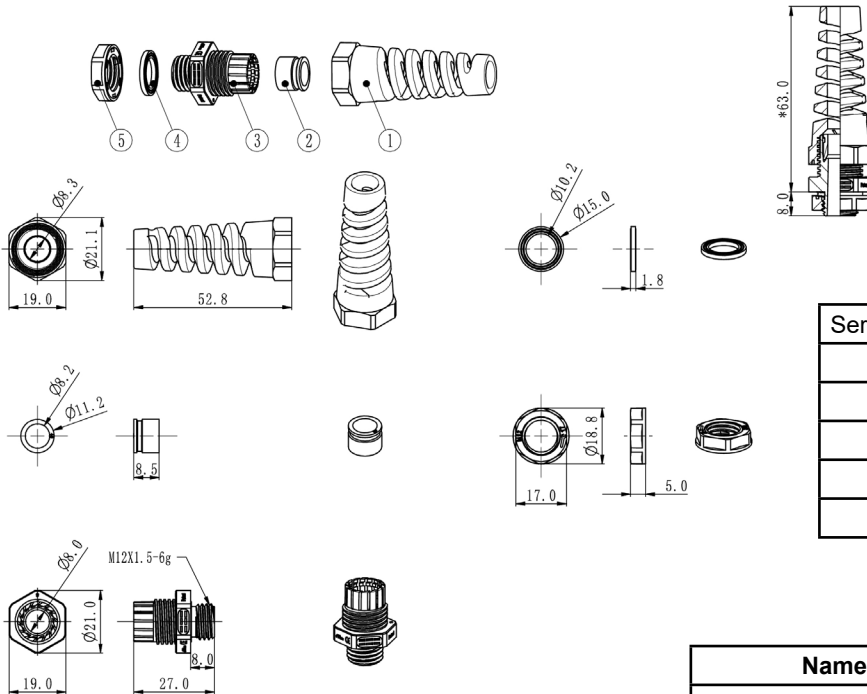

Serial No	Name	Material	Qty.
1	Sealing Nut	PA	1
2	Seal	EPDM	
3	Body	PA	
4	Gasket	EPDM	
5	Lock Nut	PA	

Name	Parameter	Unit
Air volume	200 to 300	ml/min@70mbar
Recommended Opening Size (Through Hole)	Ø12.2	mm
Cable Range	4 to 8	mm
*Torque for Sealing Nut	0.8 to 1.5	N.m
*Torque for Body	1 to 2	N.m
Operating Temp.	-40 to 100	°C
Protection Degree	IP67	-

Dimensions : Millimetres

## Note

1. "\*" indicates that parameters may change during installation.
2. The installation torque value can be adjusted according to the actual situation of customers.

## Part Number Table

Description	Part Number
Cable Gland Kit with Strain Relief, Metric, 4mm to 8mm, IP67	MP010339

**Important Notice :** This data sheet and its contents (the "Information") belong to the members of the AVNET group of companies (the "Group") or are licensed to it. No licence is granted for the use of it other than for information purposes in connection with the products to which it relates. No licence of any intellectual property rights is granted. The Information is subject to change without notice and replaces all data sheets previously supplied. The Information supplied is believed to be accurate but the Group assumes no responsibility for its accuracy or completeness, any error in or omission from it or for any use made of it. Users of this data sheet should check for themselves the Information and the suitability of the products for their purpose and not make any assumptions based on information included or omitted. Liability for loss or damage resulting from any reliance on the Information or use of it (including liability resulting from negligence or where the Group was aware of the possibility of such loss or damage arising) is excluded. This will not operate to limit or restrict the Group's liability for death or personal injury resulting from its negligence. Multicomp Pro is the registered trademark of Premier Farnell Limited 2019.

Newark.com/multicomp-pro  
Farnell.com/multicomp-pro  
sg.element14.com/b/multicomp-pro

**multicomp** PRO