

# UM11714

## PCF85263ATL-ARD evaluation board

Rev. 1.0 — 17 February 2022

User manual

### Document information

Information	Content
Keywords	PCF85263ATL, I <sup>2</sup> C-bus, RTC, Arduino port, EVK
Abstract	The PCF85263ATL-ARD evaluation board is a daughterboard equipped with Arduino port, designated for easy test and design of PCF85263A IC, tiny real-time clock/calendar with alarm function, battery switch-over and timestamp input, controlled through Fm I <sup>2</sup> C 2-wire bus. The board is fully compliant with IMXRT1050 EVK, LPCXpresso55S69 and i.MX 8M Mini LPDDR4 EVK, including GUI software control. The board can be attached to any device equipped with Arduino port.



Revision history

Rev	Date	Description
v1.0	20220217	Initial version

**IMPORTANT NOTICE****For engineering development or evaluation purposes only**

NXP provides the product under the following conditions:

This evaluation kit is for use of **ENGINEERING DEVELOPMENT OR EVALUATION PURPOSES ONLY**. It is provided as a sample IC pre-soldered to a printed-circuit board to make it easier to access inputs, outputs and supply terminals. This evaluation board may be used with any development system or other source of I/O signals by connecting it to the host MCU computer board via off-the-shelf cables. This evaluation board is not a Reference Design and is not intended to represent a final design recommendation for any particular application. Final device in an application heavily depends on proper printed-circuit board layout and heat sinking design as well as attention to supply filtering, transient suppression, and I/O signal quality.

The product provided may not be complete in terms of required design, marketing, and or manufacturing related protective considerations, including product safety measures typically found in the end device incorporating the product. Due to the open construction of the product, it is the responsibility of the user to take all appropriate precautions for electric discharge. In order to minimize risks associated with the customers' applications, adequate design and operating safeguards must be provided by the customer to minimize inherent or procedural hazards. For any safety concerns, contact NXP sales and technical support services.

## 1 Introduction

---

This document describes the PCF85263ATL-ARD evaluation board. The evaluation board is built around the PCF85263A IC and works as a daughterboard which can be connected through an Arduino port to various Arduino compatible (including original Arduino Uno R3) boards. The board is intended to test and measure the characteristics of the PCF85263A low power, tiny real-time clock/calendar with alarm and timestamp input, produced by NXP Semiconductors.

The RTC communicates with the controller / microprocessor through a bidirectional Fm (400 kHz) I<sup>2</sup>C-bus. Among the device under test (DUT) IC, the board is equipped with an Arduino port and the necessary components for easy testing, shortening the time to make measurements and check operation of the PCF85263A IC.

Additionally, the daughterboard has software support and a graphical user interface (Windows platform) for the following NXP evaluation boards: IMXRT1050 EVK Board, LPCXpresso55S69 Development Board and i.MX 8M Mini LPDDR4 EVK Board.

## 2 Finding kit resources and information on the NXP web site

---

NXP Semiconductors provides online resources for evaluation board and its supported device(s) on <http://www.nxp.com>.

The information page for PCF85263ATL-ARD evaluation board is at <http://www.nxp.com/PCF85263ATL-ARD>. The information page provides overview information, documentation, software and tools, parametrics, ordering information and a **Getting Started** tab. The Getting Started tab provides quick-reference information applicable to using the PCF85263ATL-ARD evaluation board, including the downloadable assets referenced in this document.

### 2.1 Collaborate in the NXP community

The NXP community is for sharing ideas and tips, ask and answer technical questions, and receive input on just about any embedded design topic.

The NXP community is at <http://community.nxp.com>.

## 3 Getting ready

---

Working with the PCF85263ATL-ARD requires the kit contents, additional hardware, and a Windows PC workstation with installed software.

### 3.1 Kit contents

- Assembled and tested evaluation board in an antistatic bag
- Quick Start Guide

### 3.2 Assumptions

Familiarity with the I<sup>2</sup>C bus is helpful but not required.

### 3.3 Static handling requirements

**CAUTION**

This device is sensitive to ElectroStatic Discharge (ESD). Therefore care should be taken during transport and handling. You must use a ground strap or touch the PC case or other grounded source before unpacking or handling the hardware.

### 3.4 Minimum system requirements

This evaluation board requires a Windows PC workstation. Meeting these minimum specifications should produce great results when working with this evaluation board.

- Computer with Windows 10
- One USB port (either 3.0 or 2.0 or 1.1 compatible)
- One of three EVK boards (MIMXRT1050-EVK, LPC55S69-EVK, 8MMINILPD4-EVK) along with the associated firmware / GUI software
- USB cable for power and data connection between PC and EVK board (if not included in the EVK package)

## 4 Getting to know the hardware

### 4.1 PCF85263ATL-ARD features

- Connector for external access to I<sup>2</sup>C-bus
- On-board LED for interrupt pin monitoring
- Equipped with Arduino Uno R3 port for direct connection with Arduino devices
- Fully compliant with IMXRT1050 EVK board, including GUI (Windows 10)
- Fully compliant with LPCXpresso55S69 dev. board, including GUI (Windows 10)
- Compliant with i.MX Mini LPDDR4 EVK board, including GUI (Windows 10)

*Note: For i.MX Mini LPDDR4 EVK Board is necessary to use IMX8MMINI-IARD interposer board between the EVK and PCF85263ATL-ARD daughterboard (see IMX8MMINI-IARD User Manual).*

### 4.2 Kit featured components

[Figure 1](#) identifies the main components on the board. The main elements are called out in the picture. The Arduino port connectors (J5, J6, J35, J36) are located on the bottom side of the board.

The board was developed around the DUT IC, PCF85263A (U1, see [Figure 1](#).

). Using the Arduino interface, the board can be attached to any device equipped with Arduino port. The PCF85263ATL-ARD daughterboard communicates with the host device or EVK, through an I<sup>2</sup>C-bus, with a maximum speed of 400 kHz. The I<sup>2</sup>C-bus is linked to the dedicated pins of the Arduino connector (J35) and to on-board connector (J38), allowing the user to access the I<sup>2</sup>C-bus from external. For more details about I<sup>2</sup>C description and bus transactions, see PCF85263A datasheet (NXP Semiconductors).

The INTA/CLK output (pin 9) of PC85263A IC is connected to J5, pin 3. The on-board LED (D2) can be connected through jumper header J24 to the interrupt line

for monitoring purposes. The pin 4 of the DUT (TS/CLK/INTB) can be configured as timestamp input, clock output or interrupt output pin. When is set as timestamp input, an on-board switch (SW1) can be used for timestamp event generation. The TS/CLK/INTB multipurpose pin is linked to J5, pin 4. The CLK output (pin 8) is linked to J36, pin 1 through zero-ohm resistor R35. For more details see, the schematic diagram of PCF85263ATL-ARD board (SPF-46659\_A1.pdf).

The board is powered through the Arduino connector J6 (pin 4 – 3.3V, pin 6, 7 – GND). The power is delivered to the DUT through J37 (located on the PCF85263ATL-ARD board). The role of J37 is to allow the user to perform power-off tests and current measurements. The board contains coin cell battery (BT1) for power backup and battery switch-over test. The power from battery cell is delivered through J39. D1 is the power indicator LED. The PCF85263A IC is driven by the 32.768 kHz crystal oscillator (Y1).

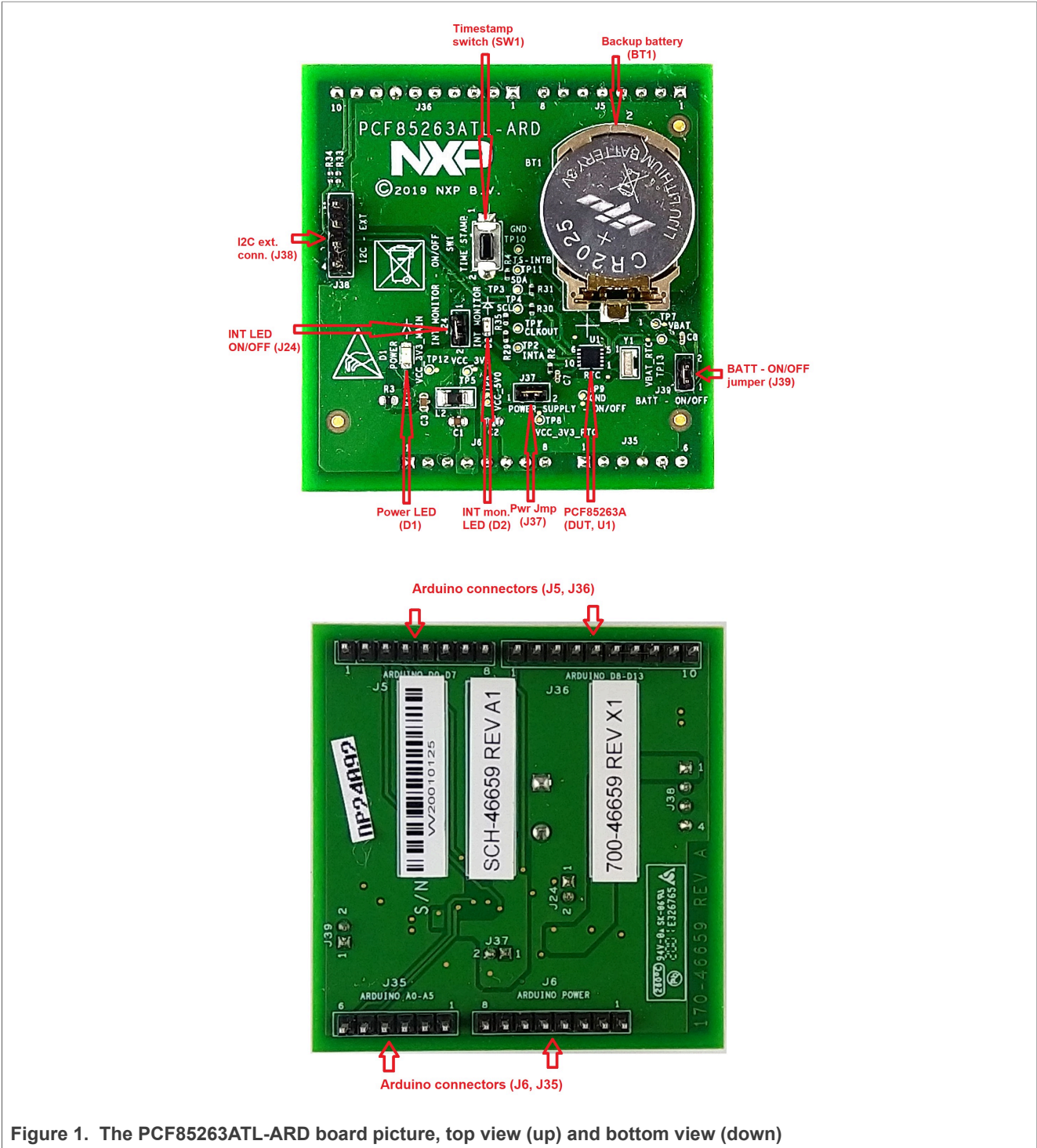

Figure 1. The PCF85263ATL-ARD board picture, top view (up) and bottom view (down)

### 4.3 Schematic diagram

The schematic diagram of PCF85263ATL-ARD is available at URL: <http://www.nxp.com/PCF85263ATL-ARD>.

#### 4.4 Arduino port

J5, J6, J35, and J36 are the mated pin headers of Arduino Uno R3 connectors, having the same electrical function and placed on the board, so that the daughterboard can be directly inserted in the Arduino port. The daughterboard uses only four signal lines. [Table 1](#) represents the pin chart of connectors, and the lines used in the circuit (see also the SPF-46659\_A1.pdf schematic file):

Table 1. Pin chart of Arduino connectors and their usage

Ref Des	#	Arduino label	PCF85263ATL-ARD function
<b>J6 (Power)</b>	1	NC	Not used
	2	IOREF	Not used
	3	RESET	Not used
	4	3.3V	Not used
	5	5V	Power supply
	6	GND	Power supply return
	7	GND	Power supply return
	8	Vin	Not used
<b>J35 (analog, digital, I<sup>2</sup>C)</b>	1	A0	Not used
	2	A1	Not used
	3	A2	Not used
	4	A3	Not used
	5	A4 / SDA	I <sup>2</sup> C – SDA
	6	A5 / SCL	I <sup>2</sup> C – SCL
<b>J5 (digital, UART, PWM)</b>	1	D0 / RX	Not used
	2	D1 / TX	Not used
	3	D2	RTC_INTA_B
	4	D3 / PWM	RTC_INTB_B
	5	D4	Not used
	6	D5 / PWM	Not used
	7	D6 / PWM	Not used
	8	D7	Not used
<b>J36 (mixed)</b>	1	D8	RTC_CLKOUT
	2	D9 / PWM	Not used
	3	D10 / SS / PWM	Not used
	4	D11 / MOSI / PWM	Not used
	5	D12 / MISO	Not used
	6	D13 / SCK	Not used
	7	GND	Power supply return
	8	AREF	Not used
	9	A4 / SDA	Not used



Table 1. Pin chart of Arduino connectors and their usage...continued

Ref Des	#	Arduino label	PCF85263ATL-ARD function
	10	A5 / SCL	Not used

The circuit is supplied with 3.3 V from Arduino port through J6 and J36. Pin no. 4 of J6 is 3.3 V power supply, while pin no. 6, 7 of J6, and pin no. 7 of J36 represents the power supply return (ground).

#### 4.5 I<sup>2</sup>C external connector (J38)

The I<sup>2</sup>C-bus of the PCF85263A can be directly accessed from external through the connector J38, located on the PCF85263ATL-ARD daughterboard. [Table 2](#) describes the pin chart of J38.

Table 2. J38 pin chart

J38 pin no.	Function	Comment
1	VCC_3V3	Power supply (3.3 V)
2	I2C_3V3_SDA	I <sup>2</sup> C-bus data (SDA)
3	I2C_3V3_SCL	I <sup>2</sup> C-bus clock (SCL)
4	GND	Power supply return (ground)

#### 4.6 Jumpers and test points

The board contains two jumpers and several test points. [Table 3](#) and [Figure 2](#) detail the jumper locations and their default configurations. [Table 4](#) describes the test points located on the PCF85263ATL-ARD board.

Table 3. PCF85263ATL-ARD jumpers

Ref Des	Label	Default	Description
J24	INT MONITOR ON / OFF	ON	ON: Enable the interrupt monitor LED (D2)
			OFF: Disable the interrupt monitor LED (D2)
J37	RTC VDD ON / OFF	ON	ON: PCF85263A (U1) VDD power-on
			OFF: PCF85263A (U1) VDD power-off
J39	RTC VBAT ON/OFF	ON	ON: PCF85263A (U1) VBAT power-on
			OFF: PCF85263A (U1) VBAT power-off

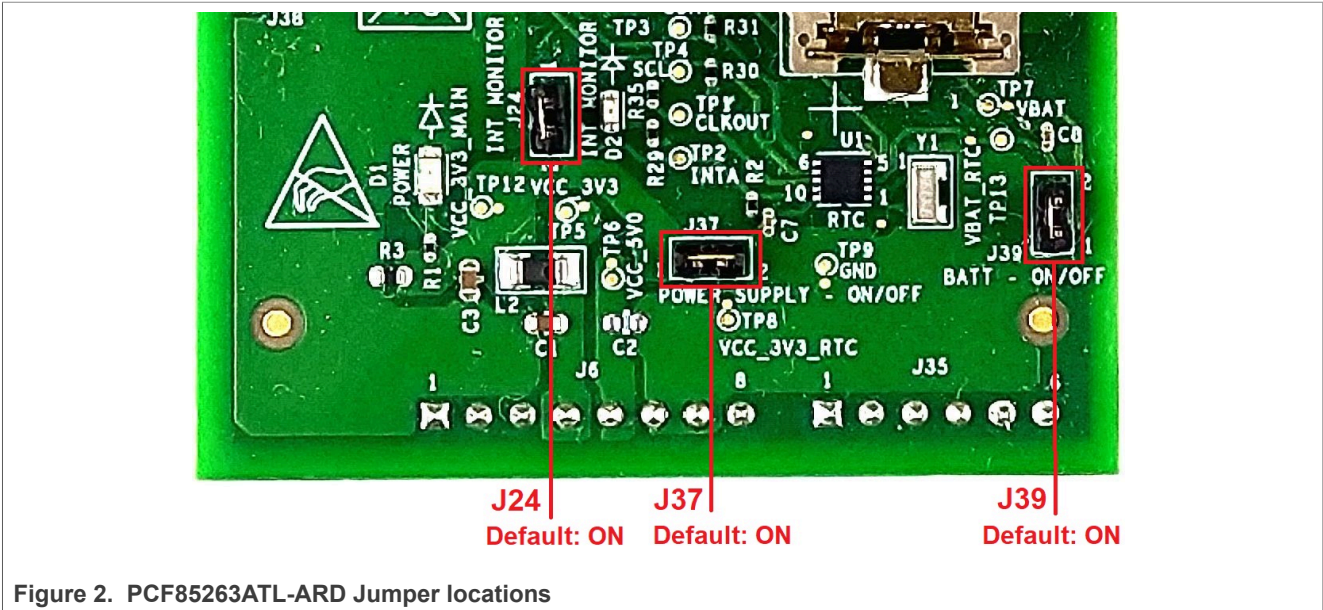

Figure 2. PCF85263ATL-ARD Jumper locations

Table 4. PCF85263ATL-ARD test points

Ref Des	Test point / jumper label	Description
TP1	CLKOUT	CLK (pin 8) of PCF85263A
TP2	INTA	INTA/CLK (pin 9) of PCF85263A
TP3	SDA	SDA (pin 6) of PCF85263A
TP4	SCL	SCL (pin 7) of PCF85263A
TP5	VCC_3V3	3.3 V power rail (Arduino connector)
TP6	VCC_5V0	5 V power rail (Arduino connector)
TP7	VBAT	The coin cell battery (BT1) voltage
TP8	VCC_3V3_RTC	3.3 V – RTC power rail
TP9	GND	Ground
TP10	GND	Ground
TP11	TS-INTB	TS/CLK/INTB (pin 4) of PCF85263A
TP12	VCC_3V3_MAIN	3.3 V main power rail
TP13	VBAT_RTC	VBAT power rail

## 5 Installing and configuring software tools

PCF85263ATL-ARD evaluation board is designed and built as a daughterboard able to work in conjunction with a motherboard equipped with an Arduino port. The board was built to be fully compatible with the following NXP Evaluation (EVK) boards:

- IMXRT1050 EVK Board;
- LPCXpresso55S69 Development Board;
- i.MX 8M Mini LPDDR4 EVK Board;

Each evaluation / development board benefits by firmware support which can be downloaded from the NXP company site ([www.nxp.com/](http://www.nxp.com/)). Before starting, the EVK motherboard must be programmed with the corresponding firmware package. Additionally, a GUI application (Windows 10) is available for download from the NXP site, allowing rapid testing and operation of PCF85263ATL-ARD daughterboard through one of the above mentioned EVKs. The GUI application is common for all three EVKs and for the RTC development board family, manufactured by NXP (PCF85063TP-ARD, PCF85063AT-ARD and PCF85263ATL-ARD). For details regarding installation of the EVK firmware and GUI host software on PC please download EVK\_Firmware\_And\_GUI\_Install\_Guide\_For\_Arduino\_Boards.pdf instruction file from NXP site ([www.nxp.com/](http://www.nxp.com/)). Once the software is installed, the first step is to select the correct combination EVK – PCF85263ATL-ARD daughterboard, and then the board can be controlled from the GUI interface. See [Section 6](#) and [Section 7](#) for more details regarding the operation of PCF85263ATL-ARD from GUI software.

## 6 Configuring the hardware

### 6.1 Using the PCF85263ATL-ARD with an IMXRT1050 EVK board

[Figure 3](#) shows the required hardware for operation of the PCF85263ATL-ARD daughterboard with IMXRT1050 EVK. The following items are necessary:

- One IMXRT1050-EVK board
- One PCF85263ATL-ARD daughterboard
- One USB-A / USB Micro-B cable
- A PC with Windows 10 operating system

The IMXRT1050 EVK motherboard can be powered by one of the three methods:

- Connecting an external 5VDC power supply to the barrel power connector (J2) on the board
- Connecting an USB cable from the PC to the Micro-B USB connector (J9) on the board
- Connecting an USB cable from the PC to the USB connector (J28) on the board. When the PC is connected in this fashion, the USB port can simultaneously act as a debug interface. Therefore, by using a single USB cable connected to J28, the EVK can be powered and at the same time linked to the PC for data exchange.

The older USB ports (from PC) are not able to deliver the necessary current (500 mA), before establishing the communication, use an external power supply (connected to J2).

From J1 on the EVK board (see ) the user can select the power configuration for the motherboard. For further details, download the IMXRT1050 EVK Board Hardware User Guide (MIMXRT1050EVKHUG.pdf) available here ([link to be set](#)).

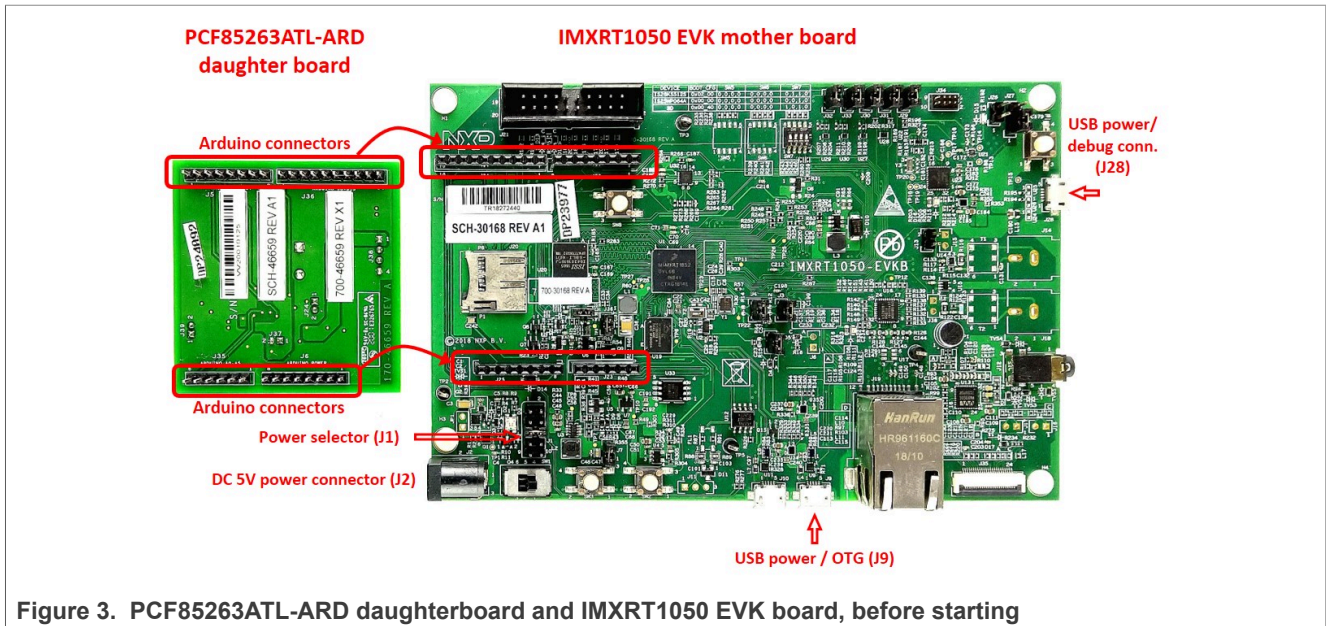

Figure 3. PCF85263ATL-ARD daughterboard and IMXRT1050 EVK board, before starting

To configure the hardware and workstation, complete the following procedure:

1. Configure the suitable power configuration of EVK (J1). If using J28 for power supply, the J1 jumper shall be placed in position 5-6. If using an external power supply (connected to J2), the jumper J1 will be placed in position 1-2.
2. Insert the PCF85263ATL-ARD daughterboard on the Arduino connector of the EVK (see [Figure 3](#) and [Figure 4](#)).
3. Using USB connector J28, connect the EVK board to an USB port of the computer.
4. Install the IMXRT1050 target firmware (download from NXP site and see UM11581, [Arduino shields GUI and firmware installation manual](#) for step-by-step instructions).
5. Install GUI application (see [UM11581, Arduino shields GUI and firmware installation manual](#)).
6. Open the GUI application to operate the device from the PC. For details regarding GUI operation see section 8 “GUI description”.

[Figure 4](#) shows the boards during operation.

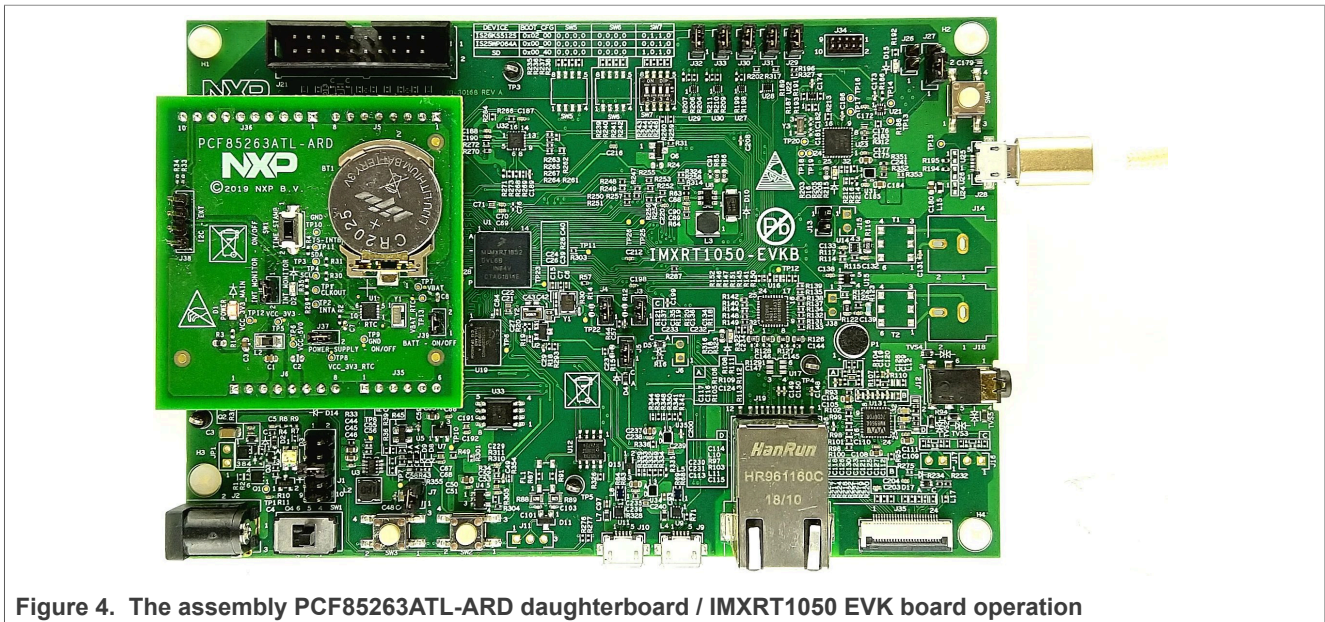

Figure 4. The assembly PCF85263ATL-ARD daughterboard / IMXRT1050 EVK board operation

## 6.2 Using the PCF85263ATL-ARD with an LPCXpresso55S69 development board

Figure 5 shows the required hardware for operation of the PCF85263ATL-ARD and LPCXpresso55S69 EVK board. This configuration consists of:

- One LPCXpresso55S69 EVK board
- One PCF85263ATL-ARD daughterboard
- One USB-A / USB Micro-B cable
- A PC with Windows 10 operating system

The LPCXpresso55S69 development board is equipped with four USB Micro-B connectors: P5, P6, P9 and P10. The board can be powered through any USB port. Using P6 USB connector to connect the board to the PC simplifies the start-up operation because P6 is designated for debugging and the USB cable thus accomplishes two tasks at the same time: powering the board, and serving as a data link between the EVK board and PC. For more details regarding power-up and operation of the LPCXpresso55S69 development board, see the *LPCXpresso55S69/LPCXpresso55S28 Development Board User Manual* [here](#).

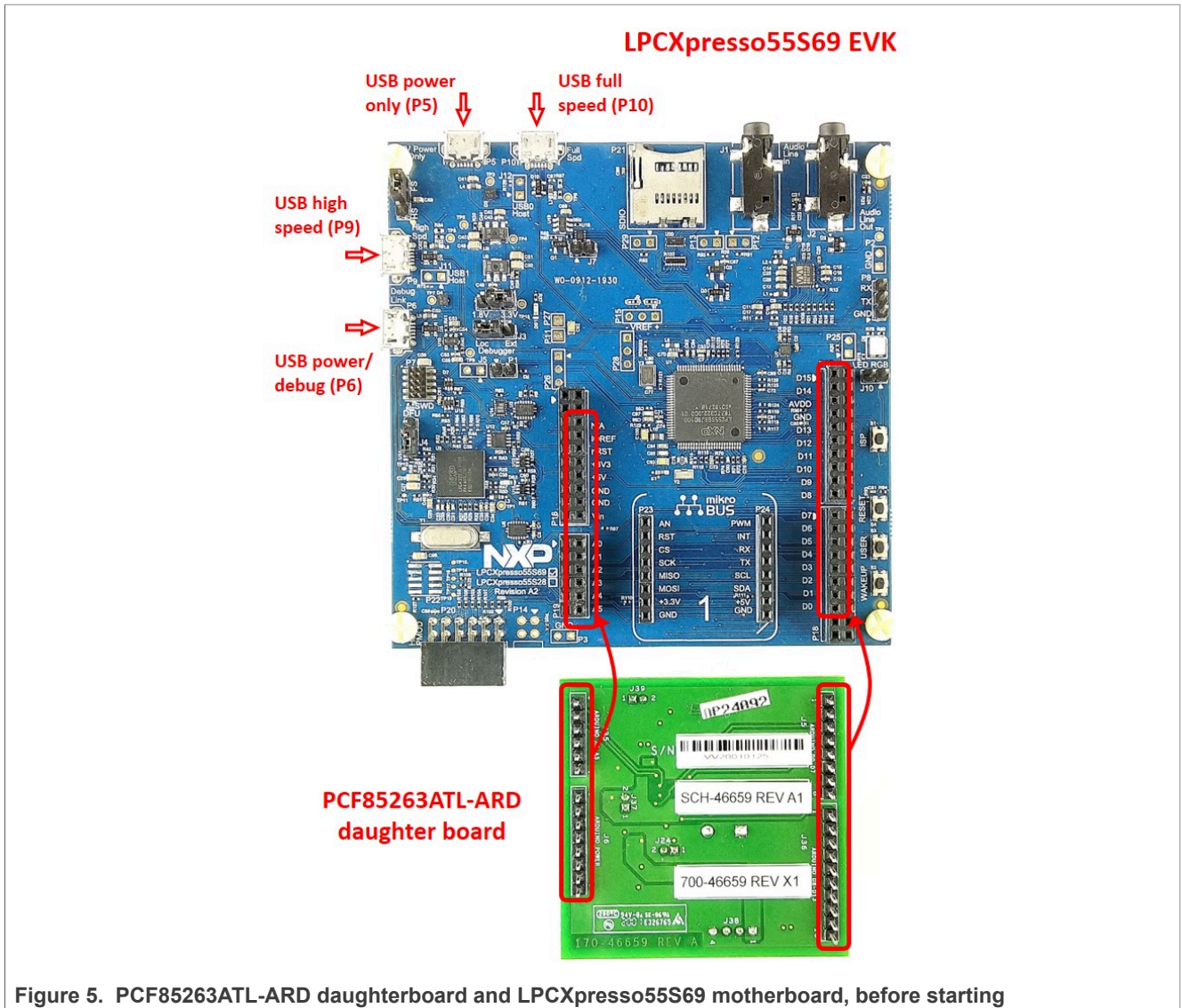

Figure 5. PCF85263ATL-ARD daughterboard and LPCXpresso55S69 motherboard, before starting

The following steps describe how to assemble, program, and operate the configuration shown in [Figure 5](#).

1. Insert the PCF85263ATL-ARD daughterboard to P16 – P19 connectors located on LPCXpresso55S69 development board (see the marked pins of P16 – P19, [Figure 5](#));
2. Connect the development board using port P6 USB port of PC;
3. Install the LPCXpresso55S69 target firmware (download from NXP site and read the *EVK\_Firmware\_And\_GUI\_Install\_Guide\_For\_Arduino\_Boards.pdf* instruction file);
4. Install GUI application on PC (see the instruction file called out in the previous step);
5. Open the GUI application to operate the device from the PC. For details regarding GUI operation see next section 8 “GUI description”;

[Figure 6](#) shows the two boards in operation.

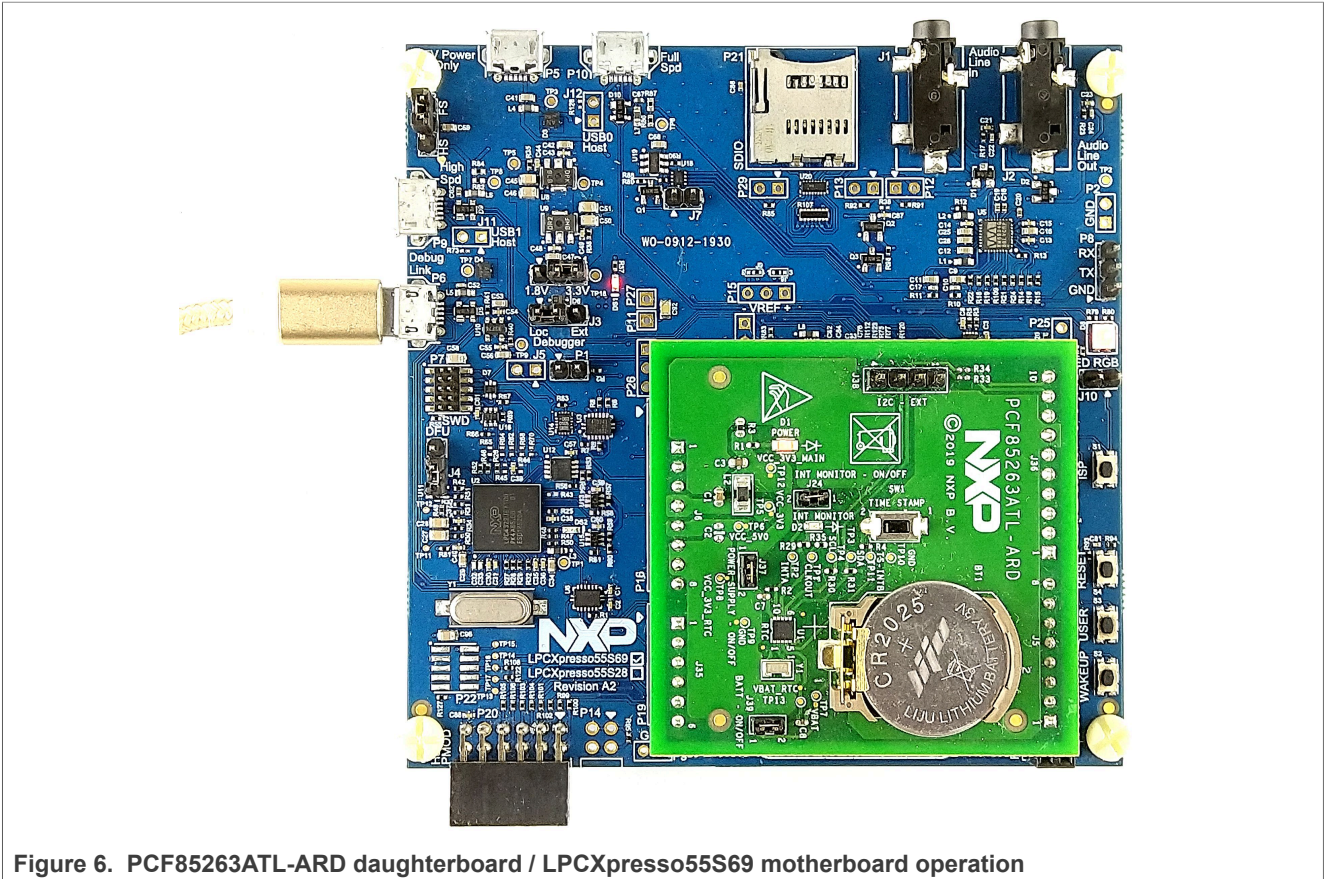

Figure 6. PCF85263ATL-ARD daughterboard / LPCXpresso55S69 motherboard operation

### 6.3 Using the PCF85263ATL-ARD with an i.MX 8M Mini LPDDR4 EVK board

When an i.MX 8M Mini LPDDR4 EVK board is used with the PCF85263ATL-ARD board, a third board (IMX8MMINI-IARD interposer board) must be used, especially designed and built as EVK – daughterboard interconnection. The EVK board i.MX 8M Mini LPDDR4 is not equipped with an Arduino port; instead it has a 2 x 20 pin expansion connector (J1003, see i.MX 8M Mini LPDDR4 EVK user manual). J1003 is a multipurpose port, containing various digital I/O lines, including specialized I<sup>2</sup>C and SPI buses. Starting from the expansion connector pin chart, an Arduino port interposer board was developed, with the role of signal-to-signal bridge between the 2 x 20 connector pins on the i.MX 8M Mini LPDDR4 EVK and the mated connectors of the Arduino port present on the PCF85263ATL-ARD daughterboard.

To operate the setup, along with the EVK and the daughterboard, a third board must be included in the setup assembly. [Figure 7](#) shows the necessary boards and how these boards are connected. The configuration consists of:

- One i.MX 8M Mini LPDDR4 EVK board
- One PCF85263ATL-ARD daughterboard
- One IMX8MMINI-IARD interposer board
- One USB-A / USB-C cable
- One USB-A / USB Micro-B cable
- A PC with Windows 10 operating system

It is recommended to attach the PCF85263ATL-ARD to the Arduino connectors of the IMX8MMINI-IARD interposer board first, and then the resulting assembly to the i.MX 8M Mini LPDDR4 EVK. This can be done by plugging J1 connector located on the interposer board to J1003 connector on the EVK.

To power-up the EVK, an USB-C type cable connected to PORT 2 of the EVK is used. The power switch SW101 on the EVK board must be set to ON position to power-up the setup. Data communication is achieved by routing a separate USB (Micro-B type) cable from an USB port on the PC to debug port (J901) on the EVK (see [Figure 7](#) and [Figure 8](#)).

The user may find details regarding power-up and operation of the setup assembly in 8MMINI LPDDR4-EVK user manual and IMX8MMINI-IARD User Manual. The files can be downloaded from [www.nxp.com/](http://www.nxp.com/).

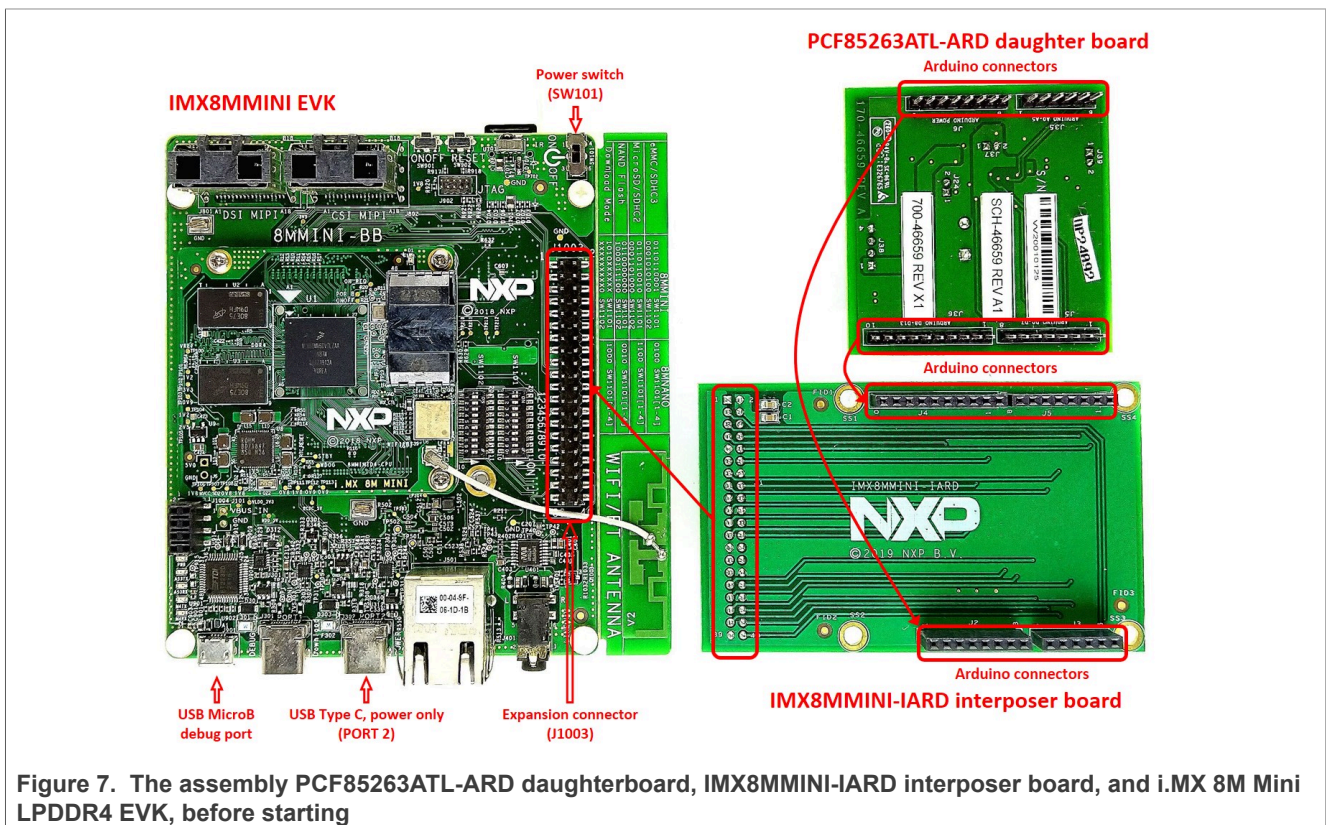

Figure 7. The assembly PCF85263ATL-ARD daughterboard, IMX8MMINI-IARD interposer board, and i.MX 8M Mini LPDDR4 EVK, before starting

To configure and operate the setup, follow the below steps:

1. Insert the PCF85263ATL-ARD onto the IMX8MMINI-IARD interposer board Arduino connectors (located on the top side);
2. Attach IMXMMINI-IARD connector plug J1 (located on the bottom of the board) into J1003 expansion board located on the top side of i.MX 8M Mini LPDDR4 EVK (see [Figure 8](#));
3. Power-up the EVK board using an USB Type C cable attached to PORT 2;
4. Connect the EVK to the PC, using an USB Micro-B cable, attached to J901 debug port;
5. Place SW101 in ON position to power-up the boards;
6. Install the MIMXRT1050 target firmware (download [UM11581](#), [Arduino shields GUI and firmware installation manual](#) from NXP site);



7. Install GUI application on the PC (see the instruction file referred in the above step);
8. Open the GUI application to operate the device from the PC. For details regarding GUI operation see [Section 7](#);

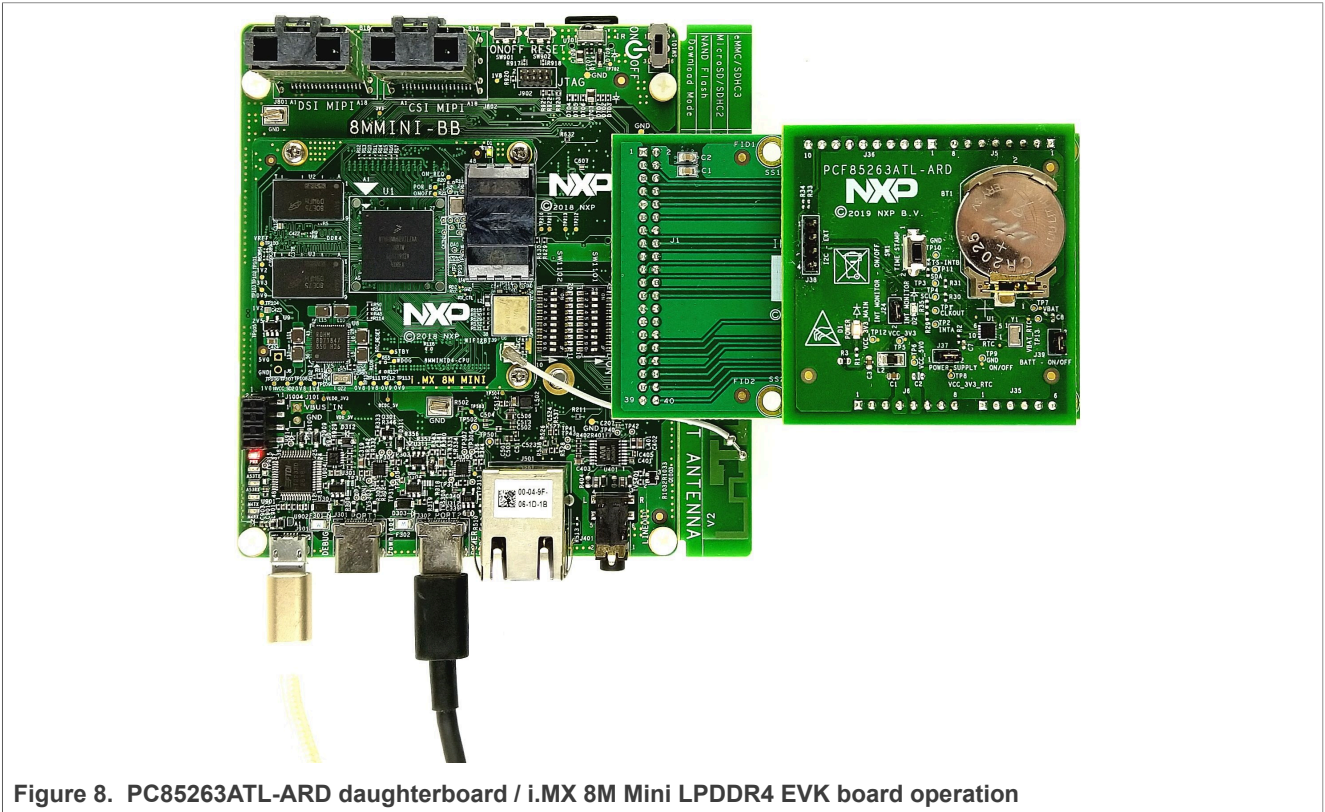

Figure 8. PCF85263ATL-ARD daughterboard / i.MX 8M Mini LPDDR4 EVK board operation

### 6.4 Using PCF85263ATL-ARD with another device

The PCF85263ATL-ARD daughterboard can be operated with other EVK board, which has an Arduino port. There are two options to connect the board: using other EVK equipped with an Arduino port, and an EVK without Arduino port. In the first case, a firmware shall be developed according with PCF85263A specifications, and then simply attach PCF85263ATL-ARD daughterboard to the EVK, to operate the board. In the second case, using the pin chart of Arduino connectors ([Table 1](#)), make the necessary electrical connections (for power, I<sup>2</sup>C-bus and control lines), and develop the desired firmware, assuring that is compliant with IC specifications. Use PCF85263A datasheet to read details about internal registers of the DUT IC and data exchange between internal controller and the EVK. Assure for correct electrical connections and avoid data conflicts on the signal lines, to prevent IC damage.

## 7 GUI description

A GUI application is available for the three EVK boards from NXP Semiconductors. The application is common for all EVKs and the development boards of the RTC family, produced by NXP Semiconductors (PCF85063TP, PCF85063A, and PCF85263A).

This section describes the GUI application and how the user can control the PCF85263ATL-ARD daughterboard from the graphical interface. First, install the GUI package and software on the PC (Windows 10). For more details, see [UM11581](#).

Once installation is complete, assure that one of the mentioned three EVK with attached PCF85263ATL-ARD daughterboard is connected to PC and powered-on. Open NXP\_GUI(PCF85063TP,PCF85263ATL,PCF85063A) GUI application. An interface will appear as is shown in [Figure 9](#).

The GUI application starts with **Settings** tab (marked with red arrow). The left side of the window displays **Board settings**. The section provides the following settings:

- **Select EVK:** displays the list of EVKs. Selecting a wrong EVK board causes the connection to fail and a pop-up window with the message: *“Unable to Connect with EVK”* appears on the screen.
- **Select COM port:** displays the port selected for communication. The port is automatically selected by the system (in the picture is COM 3).
- **Select Board:** allows the user to select the correct daughterboard (the application can support three different boards). In [Figure 9](#), the selected board is PCF85263A. Selecting a wrong daughterboard causes the connection to fail and a pop-up window with the message: *“Unable to Connect with Daughter Card”* appears on the screen.

In the right side of the window is located **Device Setting** section. From this section, two settings are available: **I2C Frequency**, which sets the I<sup>2</sup>C-bus clock to 100kHz, 400kHz or 1MHz.

- **I2C Frequency:** selects the I<sup>2</sup>C-bus clock to 100kHz, 400kHz or 1MHz.
- **RTC Mode:** selects between the RTC (**Real Time Clock**) or time elapsed (**Stop Watch**) working mode. Selecting one of two modes for the DUT, involves changes in the GUI. The second main tab name (from left to right) will reflect the selected RTC Mode in **Device Setting** section.

Assuming the correct parameters are chosen, clicking the **Connect** button establishes the connection with the EVK. In the bottom side of the GUI window a status bar shows in real time the status regarding connection between PC and the EVK.

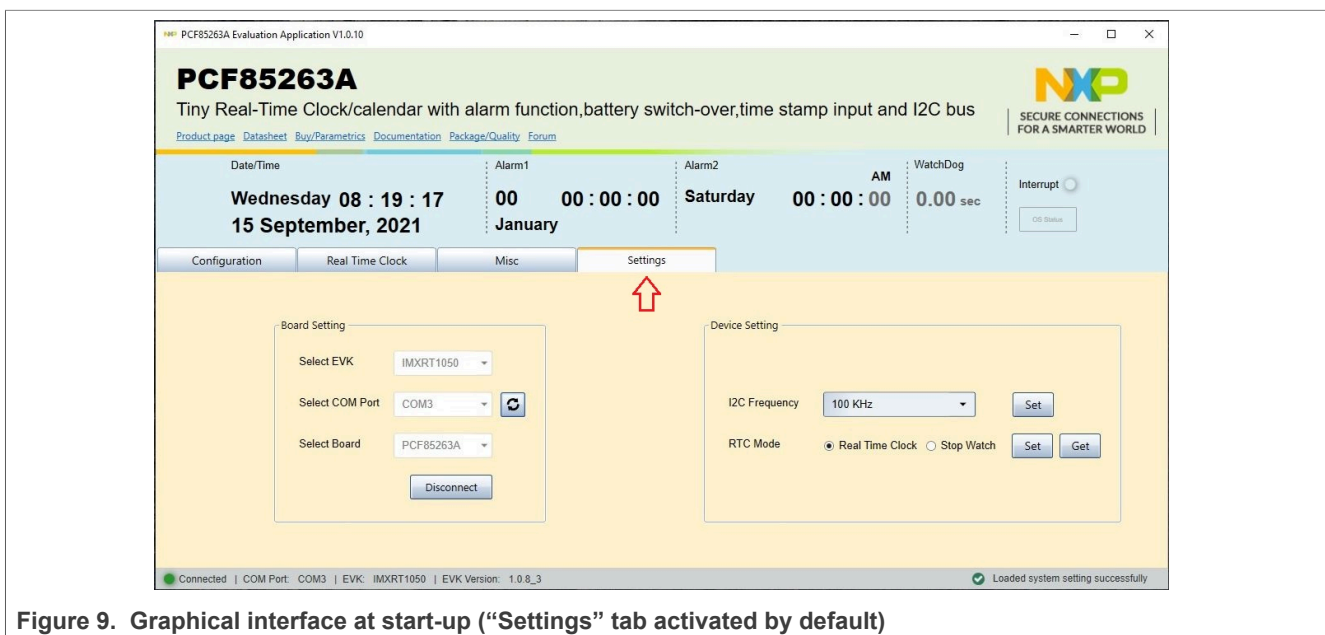

Figure 9. Graphical interface at start-up (“Settings” tab activated by default)

If from **Device Setting** section the **Real Time Clock** mode is selected, the second main tab name is **Real Time Clock**. Clicking on **Real Time Clock** tab, a new window appears (see [Figure 10](#)). From this section the user can control the internal registers of

the PCF85263A IC for real-time clock, alarm, and timestamps functions when the RTC is in real-time clock mode. A subset of secondary tabs is available in the upper left of the window. [Table 5](#) details the function and the register address for each tab. For more details about register map, see the datasheet of PCF85263A IC (section RTC mode registers).

Table 5. The secondary tabs under the Real Time Clock main tab

Tab name	The picture in:	Register address	Register function
Date & Time	<a href="#">Figure 10</a>	00h – 07h	RTC time and date registers
Alarm	<a href="#">Figure 11</a>	08h – 10h	RTC alarm #1, #2; RTC alarm enables
Timestamps	<a href="#">Figure 12</a>	11h – 22h	RTC timestamp #1 – #3
Timestamp Mode	<a href="#">Figure 13</a>	23h	RTC timestamp mode control

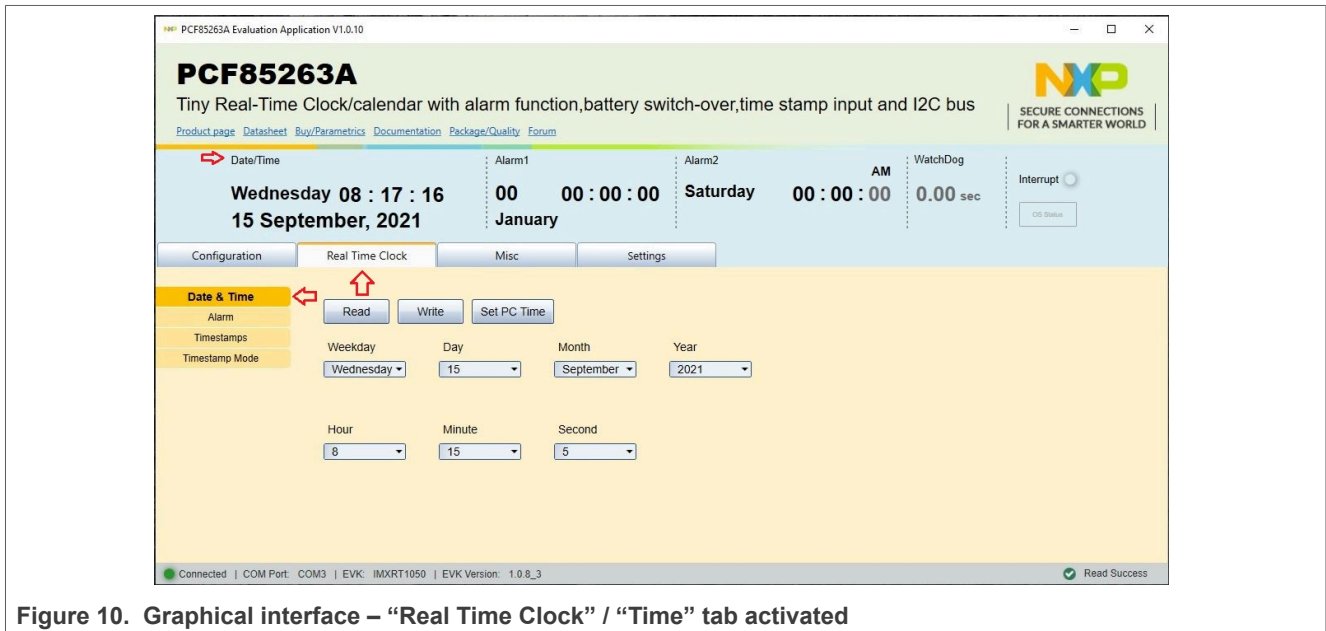

Figure 10. Graphical interface – “Real Time Clock” / “Time” tab activated

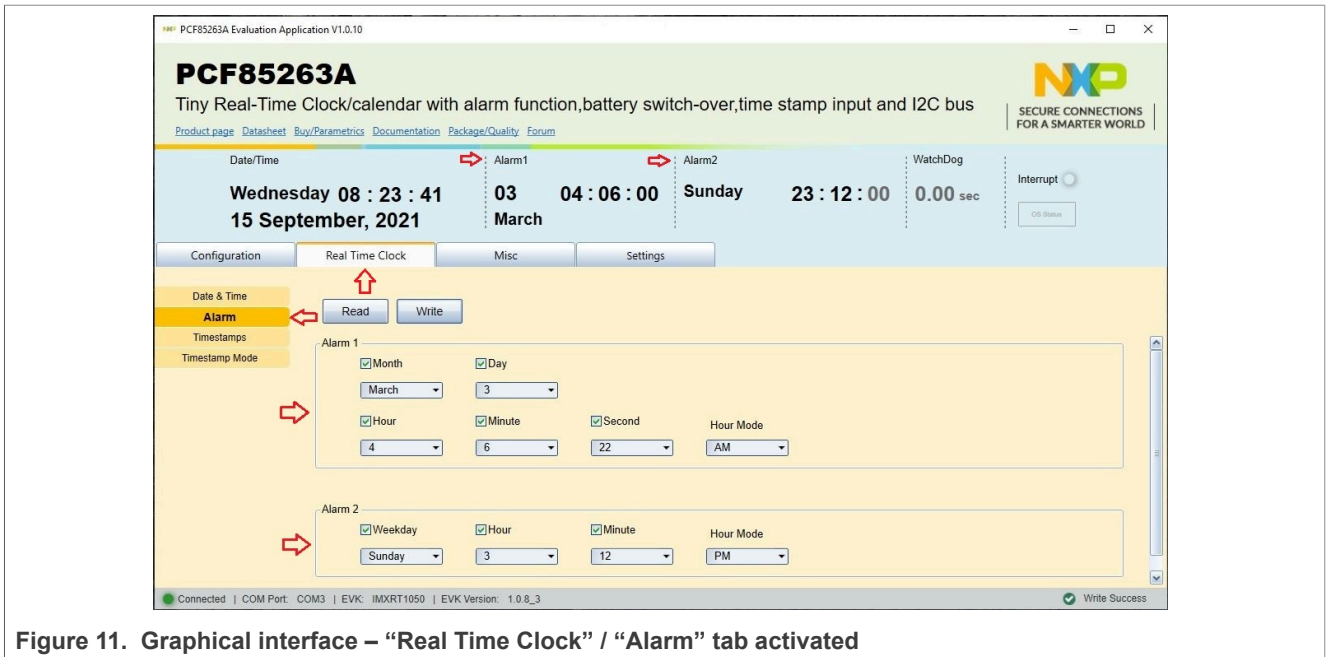

Figure 11. Graphical interface – “Real Time Clock” / “Alarm” tab activated

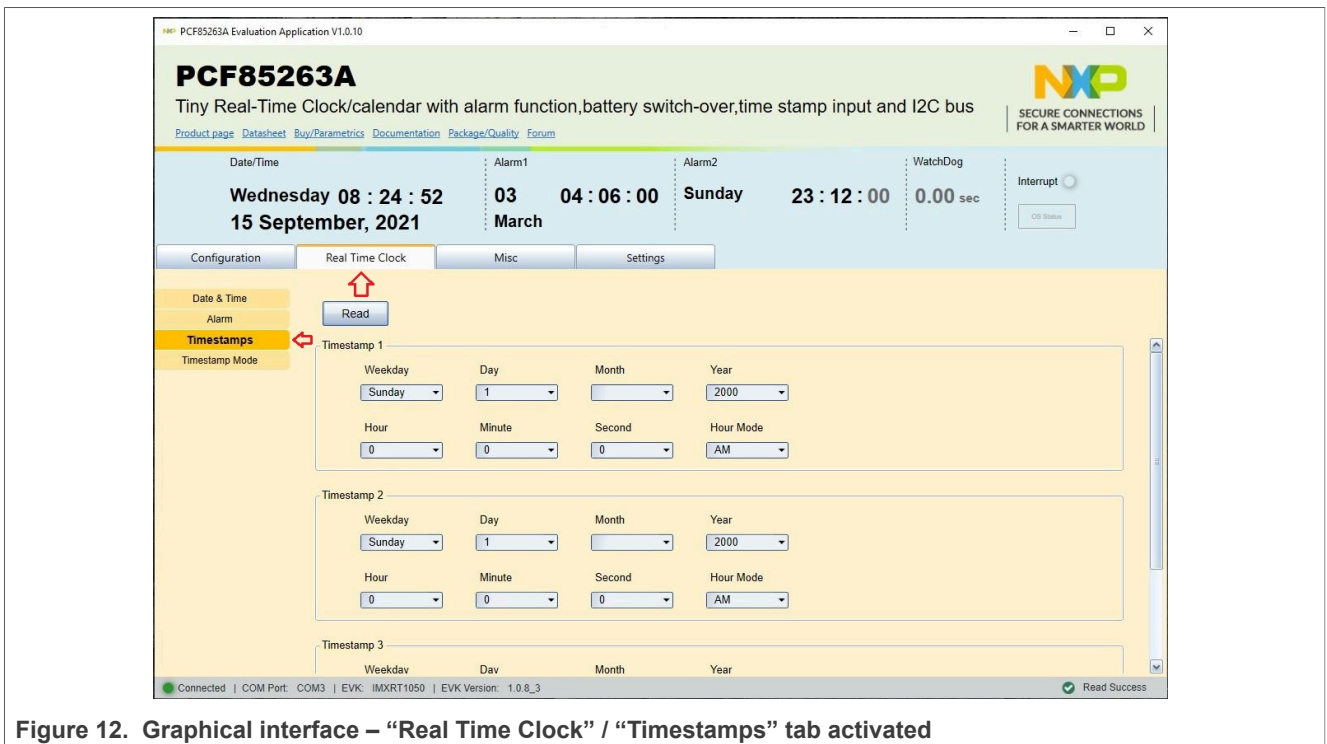

Figure 12. Graphical interface – “Real Time Clock” / “Timestamps” tab activated

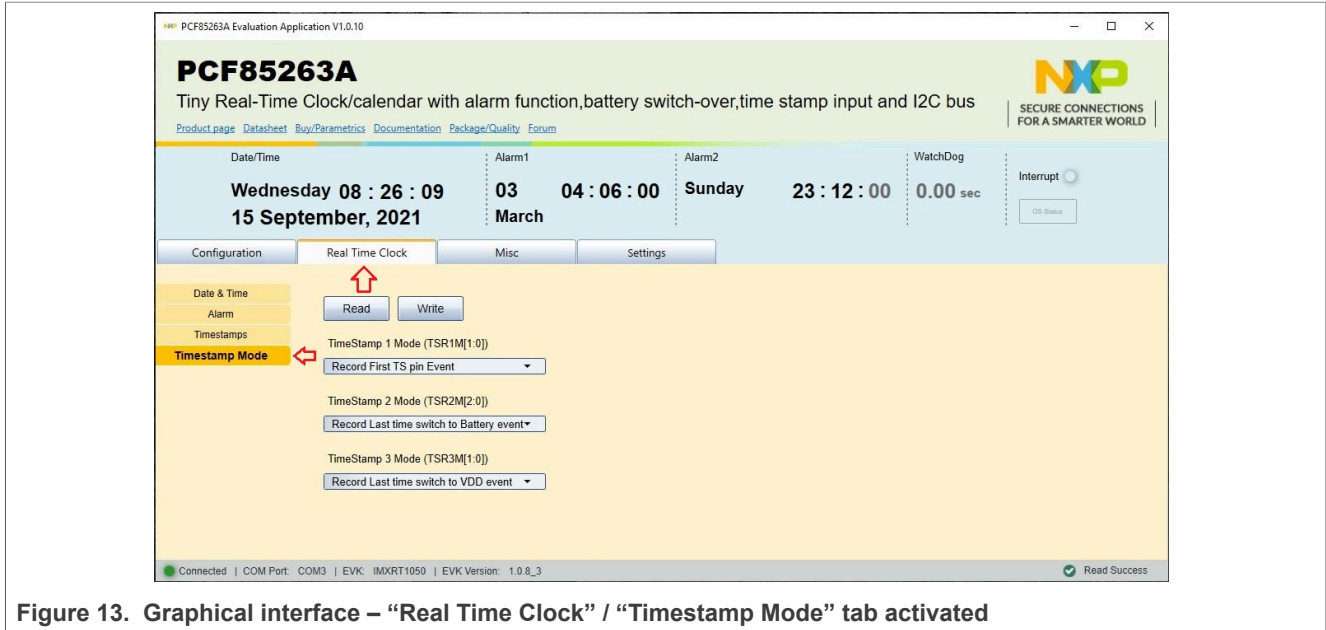

Figure 13. Graphical interface – “Real Time Clock” / “Timestamp Mode” tab activated

If from **Device Setting** section the **Stop Watch** mode is selected, the second main tab name is switched to **Stop Watch**. Clicking on **Stop Watch** tab, a different window appears (see [Figure 14](#)). From this section the user can control the internal registers of the PCF85263A IC for real-time clock, alarm, and timestamps functions, when the RTC is in stop watch mode. A new subset of secondary tabs is available in the upper left of the window. [Table 6](#) details the function and the register address for each tab. For more details about register map, see the datasheet of PCF85263A IC (section Stop-watch mode registers).

Table 6. The secondary tabs under the Stop Watch main tab

Tab name	The picture in:	Register address	Register function
<b>Date &amp; Time</b>	<a href="#">Figure 14</a>	00h – 05h	RTC time and date registers
<b>Alarm</b>	<a href="#">Figure 15</a>	08h – 10h	RTC alarm #1, #2; RTC alarm enables
<b>Timestamps</b>	<a href="#">Figure 16</a>	11h – 15h; 17h – 1Bh; 1Dh – 21h	RTC timestamp #1 – #3
<b>Timestamp Mode</b>	<a href="#">Figure 17</a>	23h	RTC timestamp mode control

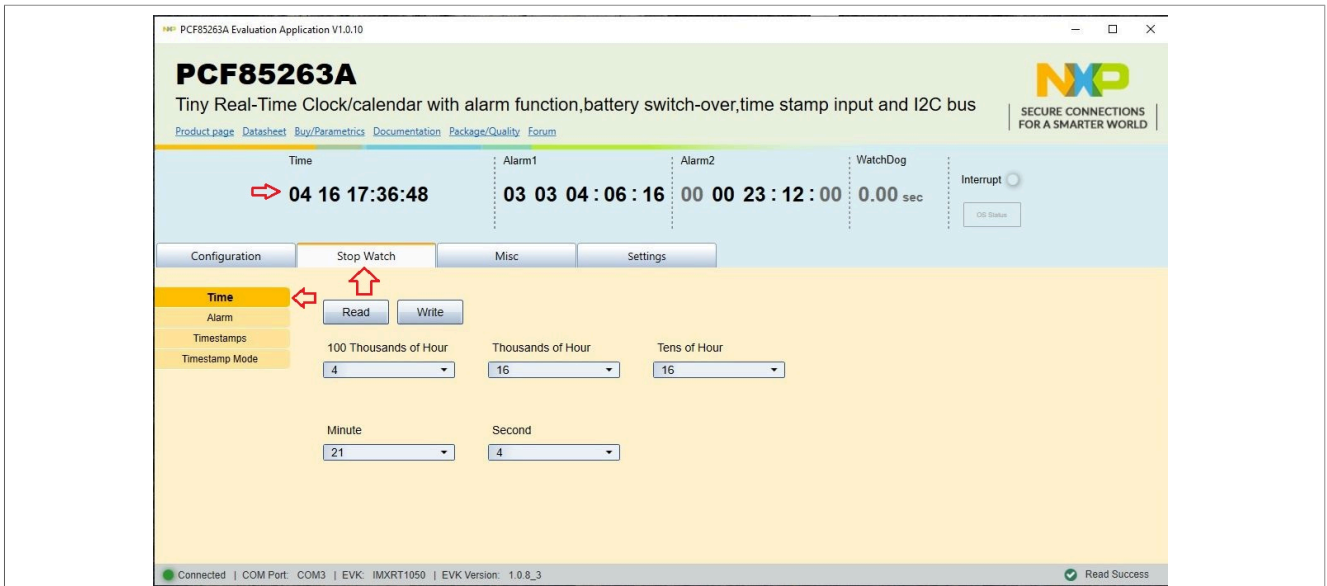

Figure 14. Graphical interface – “Stop Watch” / “Time” tab activated

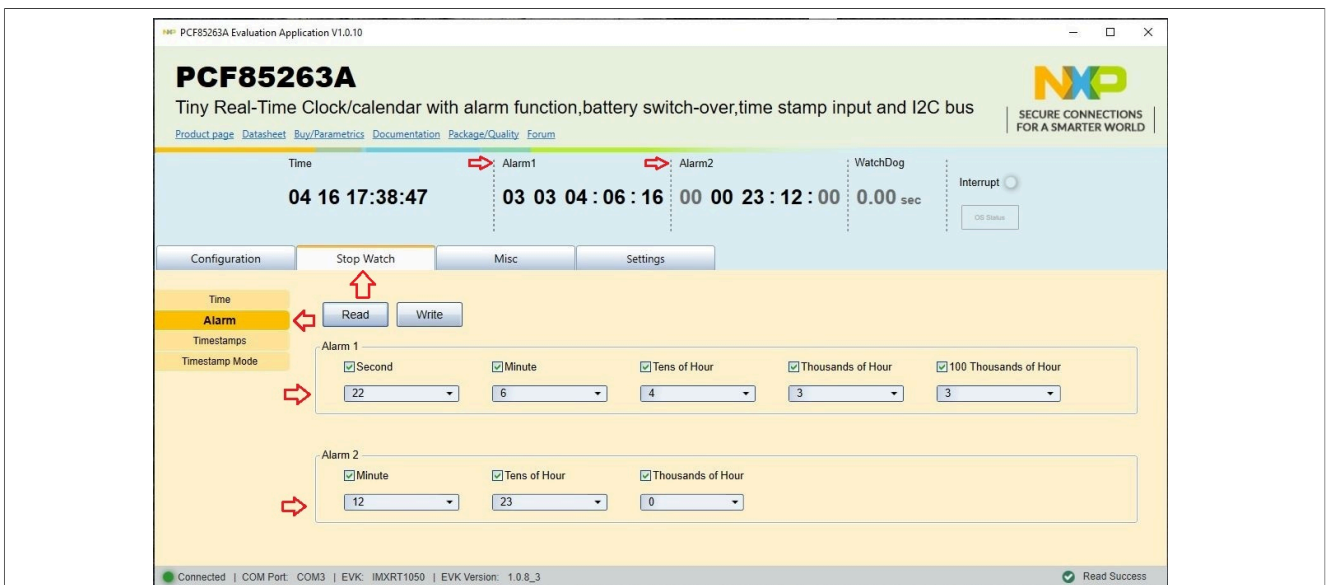

Figure 15. Graphical interface – “Stop Watch” / “Alarm” tab activated

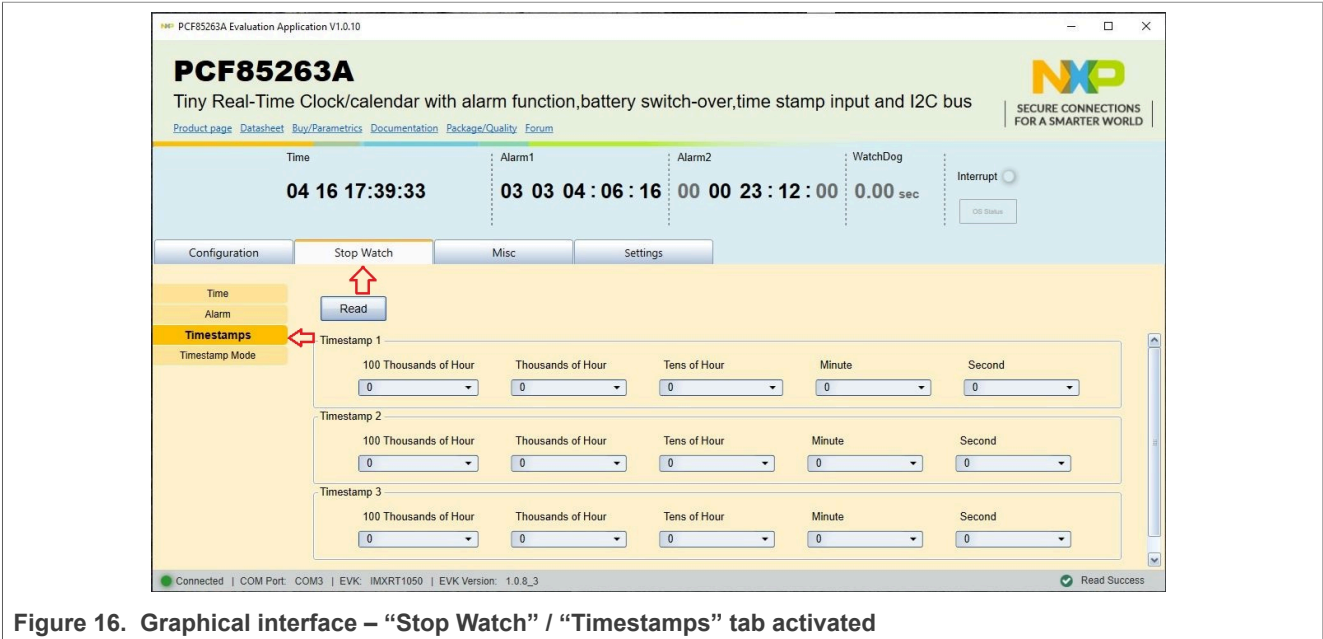

Figure 16. Graphical interface – “Stop Watch” / “Timestamps” tab activated

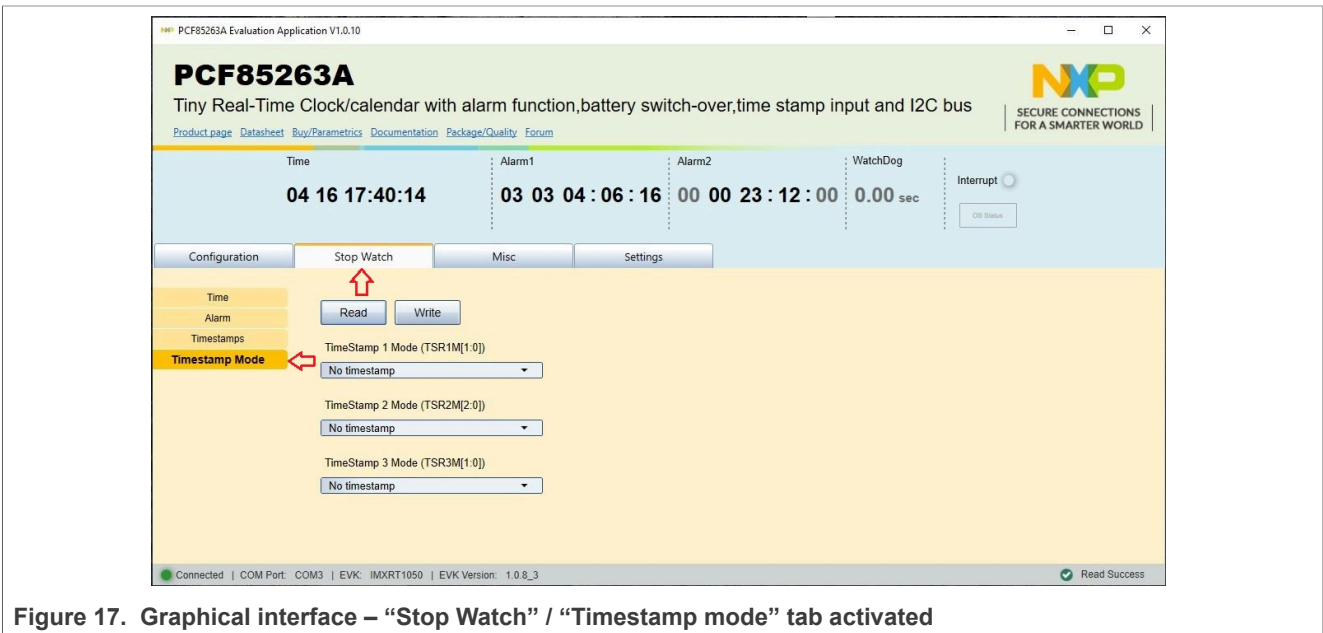

Figure 17. Graphical interface – “Stop Watch” / “Timestamp mode” tab activated

The **Configuration** tab also contains a subset of secondary tabs, available in the upper left of the window. [Table 7](#) details the function and the register address for each tab. For more details about register map, see the datasheet of PCF85263A IC (section Control and function registers).

Table 7. The secondary tabs under Configuration main tab

Tab name	The picture in:	Register address	Register function
Oscillator/Clock	<a href="#">Figure 18</a>	25h	Control registers
Pin I/O	<a href="#">Figure 19</a>	27h	

Table 7. The secondary tabs under Configuration main tab...continued

Tab name	The picture in:	Register address	Register function
Battery Switch	<a href="#">Figure 20</a>	26h	
Function	<a href="#">Figure 21</a>	28h	
Offset	<a href="#">Figure 22</a>	24h	Offset register
Interrupts	<a href="#">Figure 23</a>	29h, 2Ah	Control registers
Flags	<a href="#">Figure 24</a>	2Bh	
Reset/Stop Enable	<a href="#">Figure 25</a>	2Eh, 2Fh	Stop register; Reset register

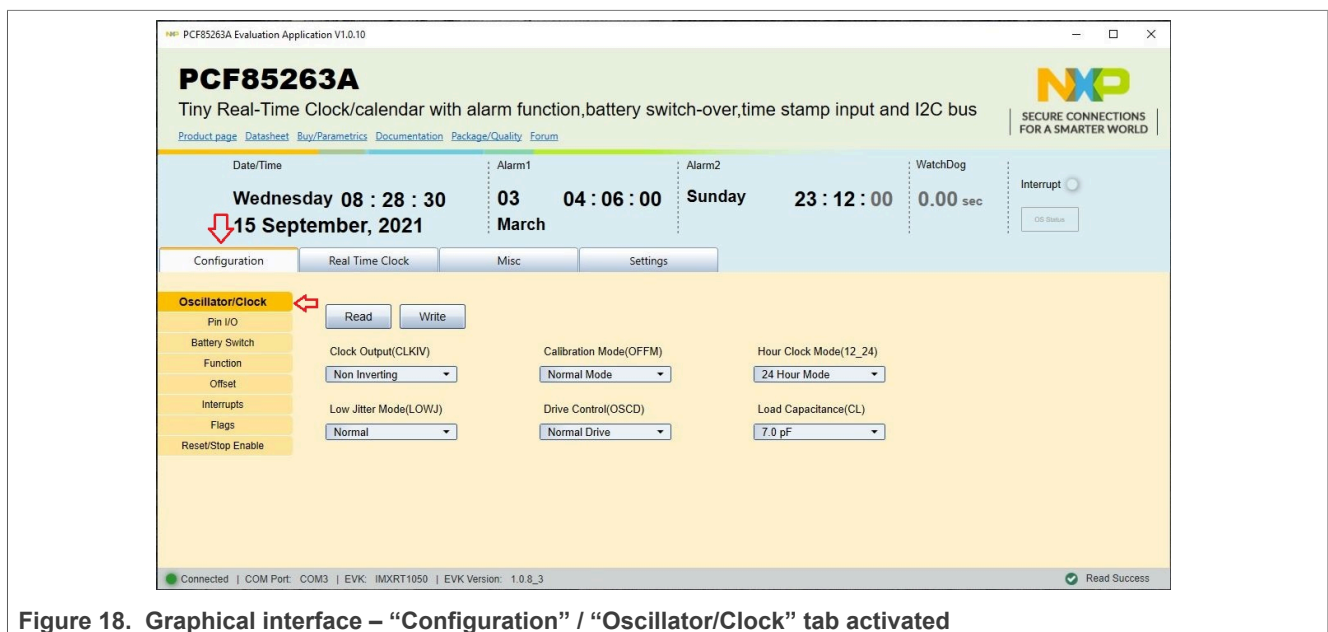

Figure 18. Graphical interface – “Configuration” / “Oscillator/Clock” tab activated



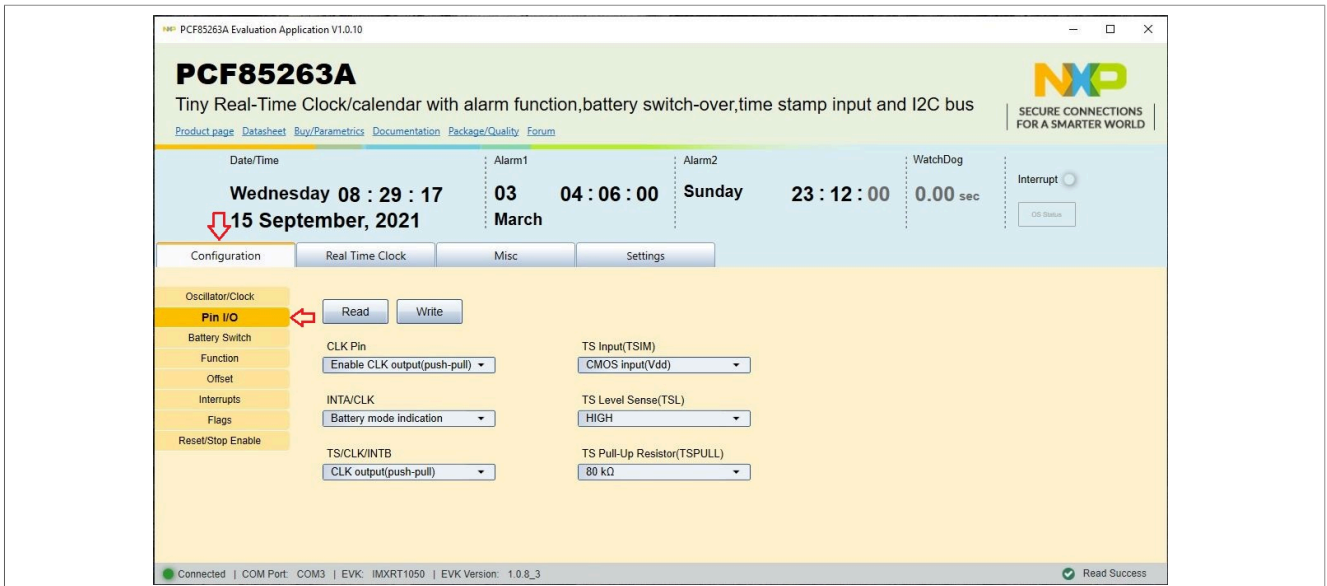

Figure 19. Graphical interface – “Configuration” / “Pin I/O” tab activated

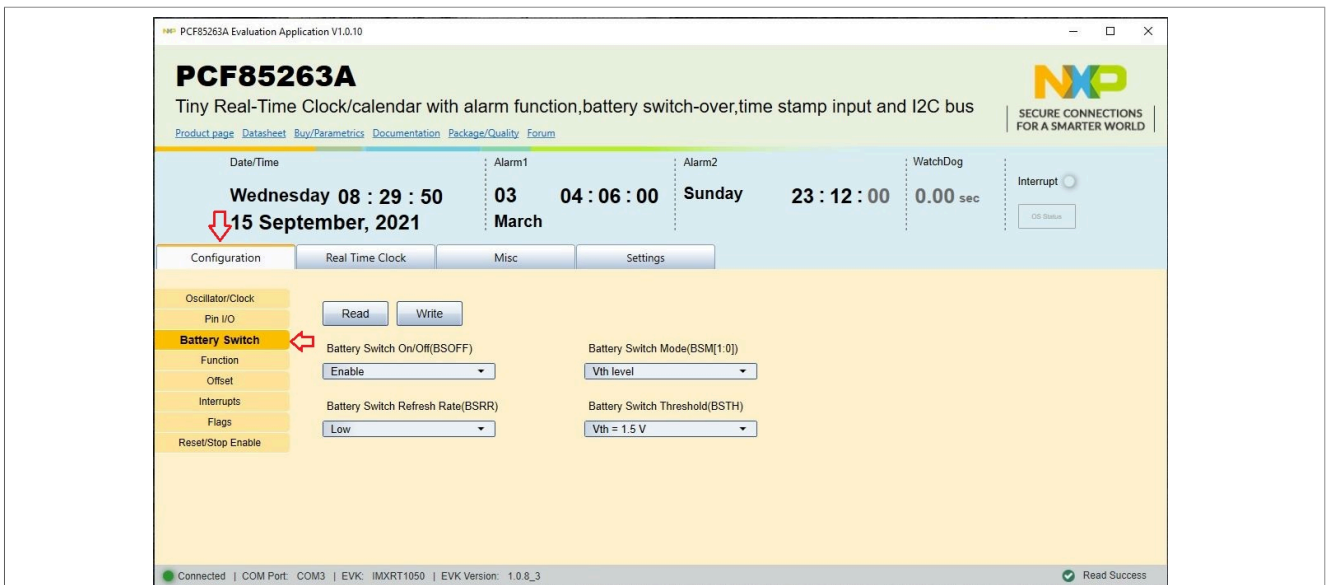

Figure 20. Graphical interface – “Configuration” / “Battery Switch” tab activated

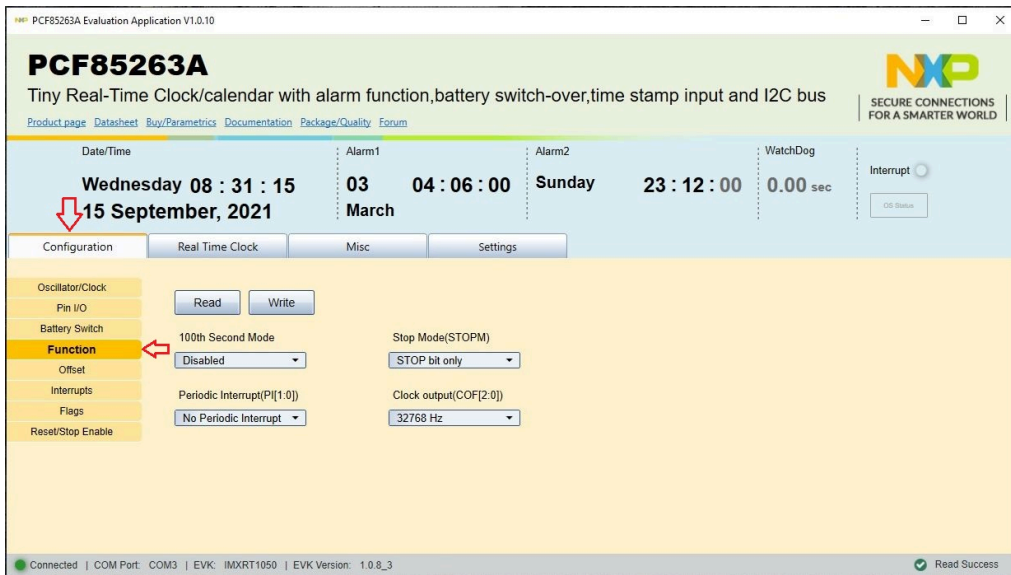

Figure 21. Graphical interface – “Configuration” / “Function” tab activated

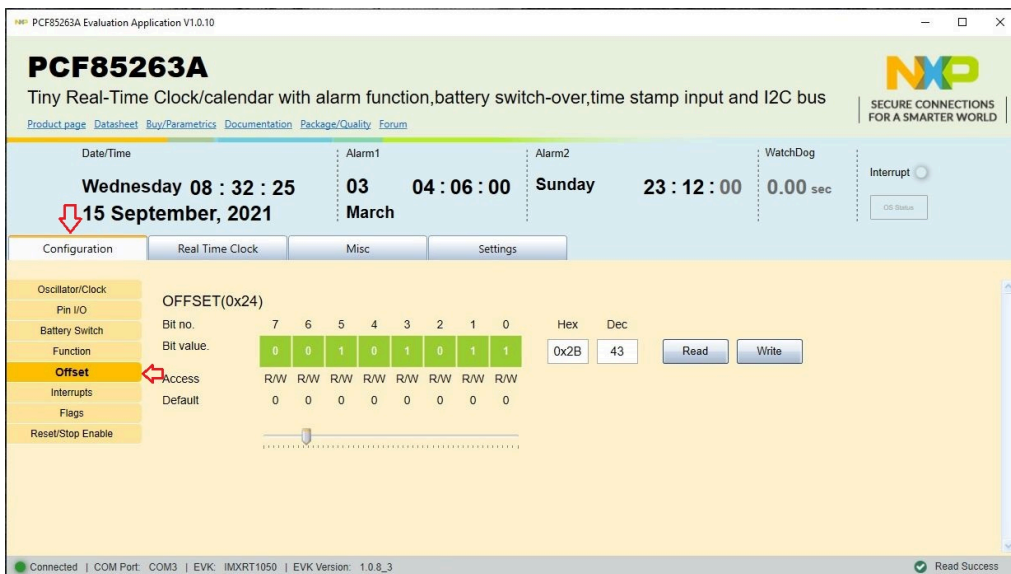

Figure 22. Graphical interface – “Configuration” / “Offset” tab activated

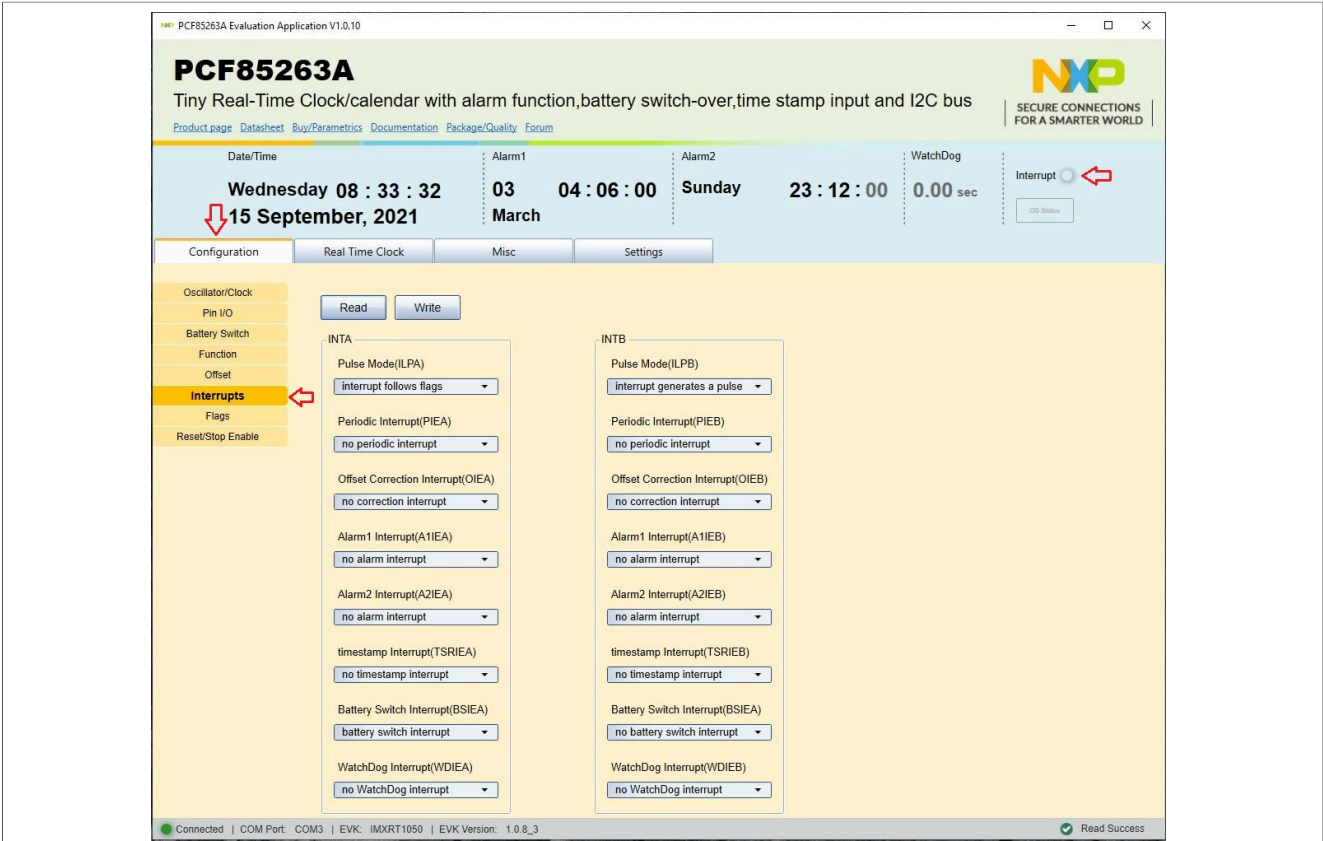

Figure 23. Graphical interface – “Configuration” / “Interrupts” tab activated

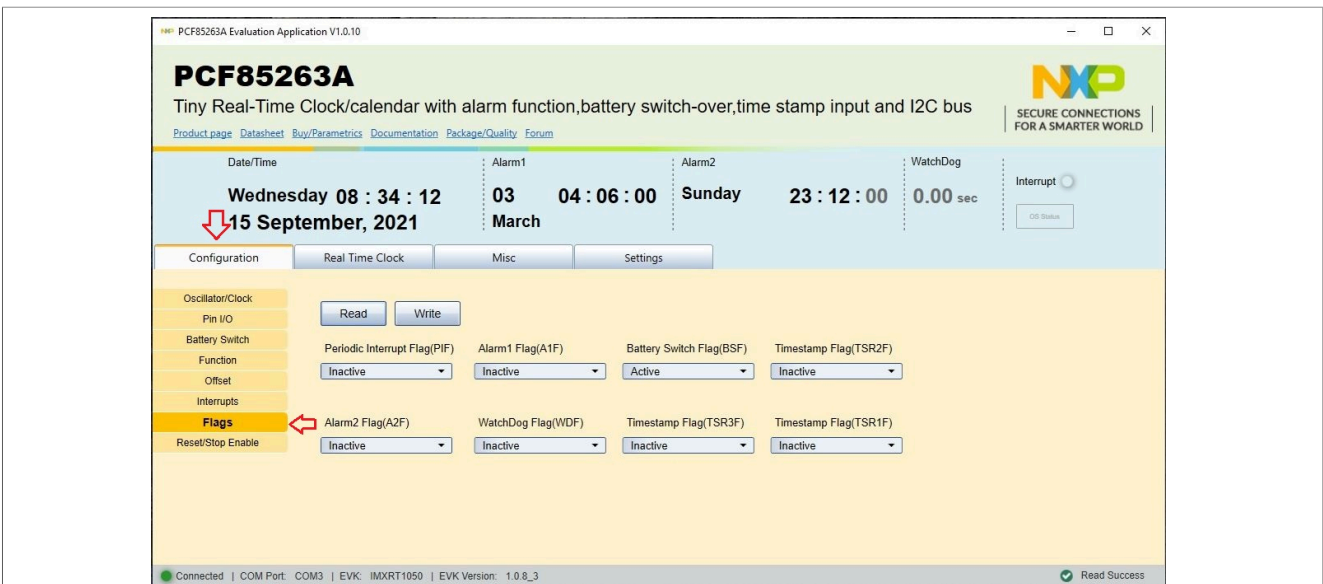

Figure 24. Graphical interface – “Configuration” / “Flags” tab activated

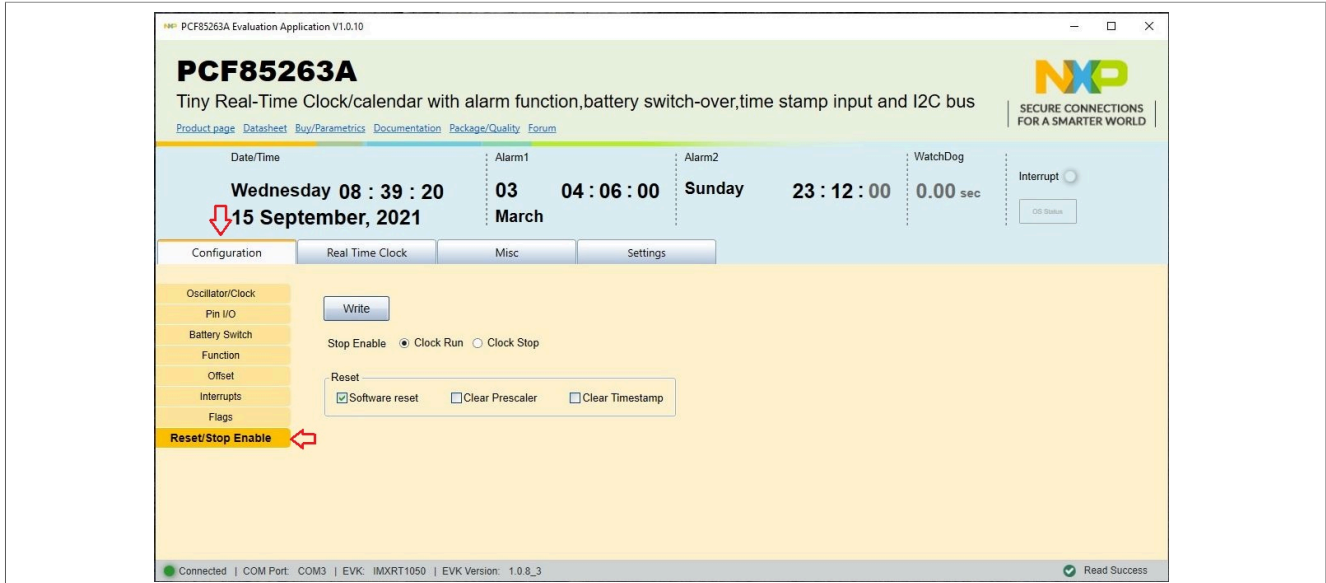

Figure 25. Graphical interface – “Configuration” / “Reset/Stop Enable” tab activated

The **Misc** tab contains a subset of two secondary tabs. [Table 8](#) details the function and the register address for the two tabs. For more details about register map, see the datasheet of PCF85263A IC (section Control and function registers).

Table 8. The secondary tabs under the Misc main tab

Tab name	The picture in:	Register address	Register function
RAM BYTE	<a href="#">Figure 26</a>	2Ch	RAM byte
WatchDog	<a href="#">Figure 27</a>	2Dh	WatchDog registers

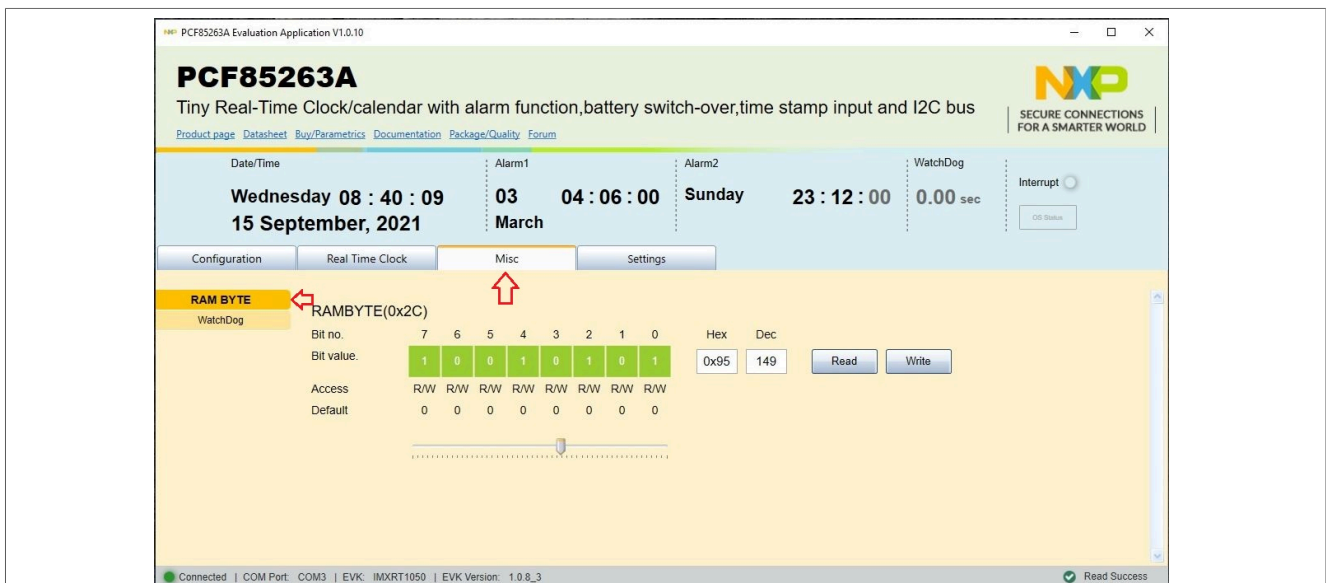

Figure 26. Graphical interface – “Misc” / “RAM BYTE” tab activated

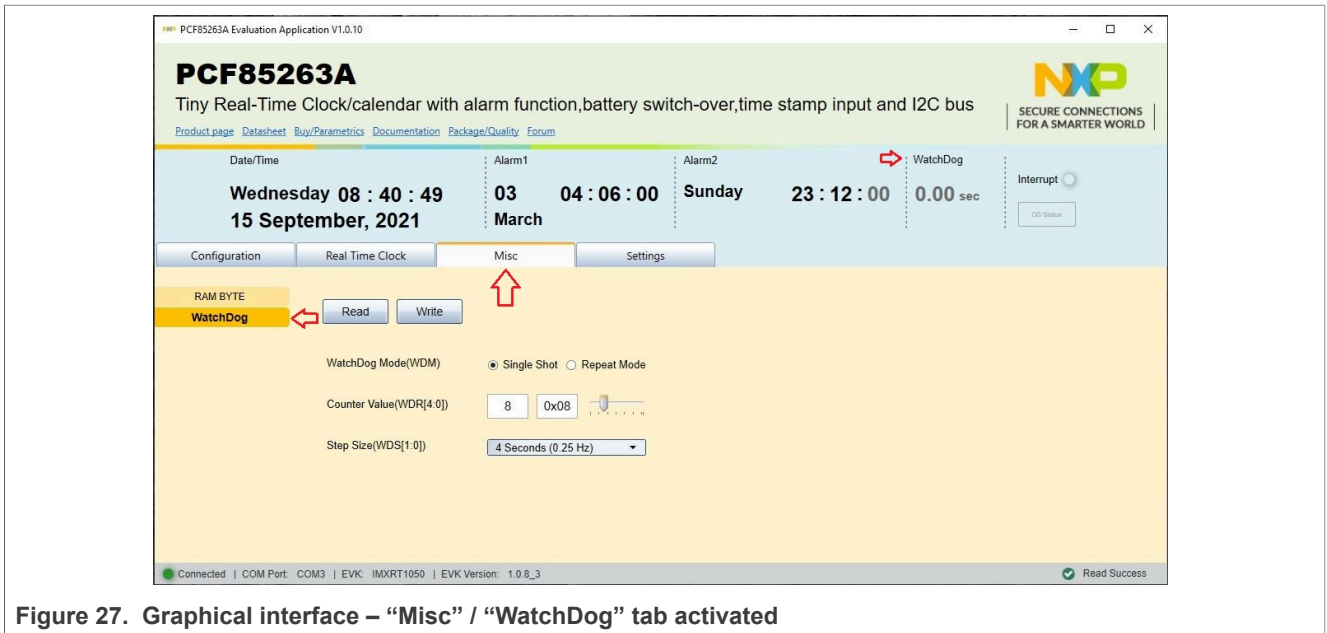

Figure 27. Graphical interface – “Misc” / “WatchDog” tab activated

## 8 Abbreviations

Table 9. Abbreviations

Acronym	Description
DUT	Device Under Test
ESD	Electro Static Discharge
EVK	Evaluation Board
GUI	Graphical User Interface
I <sup>2</sup> C bus	Inter-Integrated Circuit bus
IC	Integrated Circuit
I/O	Input / Output
LED	Light Emitting Diode
PC	Personal Computer
RTC	Real-Time Clock
USB	Universal Serial Bus

## 9 References

---

1. *PCF85263A, Tiny Real-Time Clock/calendar with alarm function, battery switch-over, time stamp input, and I<sup>2</sup>C-bus*  
Product data sheet; NXP Semiconductors;
2. *MIMxrt1050 EVK Board Hardware User's Guide*  
User manual; NXP Semiconductors;
3. *i.MX RT1050 Crossover Processors Data Sheet for Consumer Products*  
Data sheet; NXP Semiconductors;
4. *UM11158 – LPCXpresso55S69 Development Board*  
User manual; NXP Semiconductors;
5. *LPC556x 32-bit ARM Cortex-M33; M33 coprocessor, TrustZone, PowerQuad, CASPER, 320KB SRAM; 640 KB flash, USB HS, Flexcomm Interface, SDIO, 32-bit counter/timers, SCTimer/PWM, PLU, 16-bit 1.0 Msamples/sec ADC, Comparator, Temperature Sensor, AES, PUF, SHA, CRC, RNG*  
Product data sheet; NXP Semiconductors;
6. *i.MX 8M Mini LPDDR4 EVK Board Hardware User's Guide*  
User guide; NXP Semiconductors;
7. *i.MX 8M Mini Application Processor Datasheet for Consumer Products*  
Data sheet; NXP Semiconductors;
8. *i.MX 8M Mini Application Processor Reference Manual*  
Reference manual; NXP Semiconductors;
9. *Arduino Uno R3 Reference Manual*  
Reference manual; NXP Semiconductors;
10. *IMX8MMINI-IARD interposer board User Manual*  
User manual; NXP Semiconductors;
11. *NXP EVK Firmware and GUI Installation Guide for Arduino Series Boards*  
User manual; NXP Semiconductors;

## 10 Legal information

### 10.1 Definitions

**Draft** — A draft status on a document indicates that the content is still under internal review and subject to formal approval, which may result in modifications or additions. NXP Semiconductors does not give any representations or warranties as to the accuracy or completeness of information included in a draft version of a document and shall have no liability for the consequences of use of such information.

### 10.2 Disclaimers

**Limited warranty and liability** — Information in this document is believed to be accurate and reliable. However, NXP Semiconductors does not give any representations or warranties, expressed or implied, as to the accuracy or completeness of such information and shall have no liability for the consequences of use of such information. NXP Semiconductors takes no responsibility for the content in this document if provided by an information source outside of NXP Semiconductors.

In no event shall NXP Semiconductors be liable for any indirect, incidental, punitive, special or consequential damages (including - without limitation - lost profits, lost savings, business interruption, costs related to the removal or replacement of any products or rework charges) whether or not such damages are based on tort (including negligence), warranty, breach of contract or any other legal theory.

Notwithstanding any damages that customer might incur for any reason whatsoever, NXP Semiconductors' aggregate and cumulative liability towards customer for the products described herein shall be limited in accordance with the Terms and conditions of commercial sale of NXP Semiconductors.

**Right to make changes** — NXP Semiconductors reserves the right to make changes to information published in this document, including without limitation specifications and product descriptions, at any time and without notice. This document supersedes and replaces all information supplied prior to the publication hereof.

**Suitability for use** — NXP Semiconductors products are not designed, authorized or warranted to be suitable for use in life support, life-critical or safety-critical systems or equipment, nor in applications where failure or malfunction of an NXP Semiconductors product can reasonably be expected to result in personal injury, death or severe property or environmental damage. NXP Semiconductors and its suppliers accept no liability for inclusion and/or use of NXP Semiconductors products in such equipment or applications and therefore such inclusion and/or use is at the customer's own risk.

**Applications** — Applications that are described herein for any of these products are for illustrative purposes only. NXP Semiconductors makes no representation or warranty that such applications will be suitable for the specified use without further testing or modification.

Customers are responsible for the design and operation of their applications and products using NXP Semiconductors products, and NXP Semiconductors accepts no liability for any assistance with applications or customer product design. It is customer's sole responsibility to determine whether the NXP Semiconductors product is suitable and fit for the customer's applications and products planned, as well as for the planned application and use of customer's third party customer(s). Customers should provide appropriate design and operating safeguards to minimize the risks associated with their applications and products.

NXP Semiconductors does not accept any liability related to any default, damage, costs or problem which is based on any weakness or default in the customer's applications or products, or the application or use by customer's third party customer(s). Customer is responsible for doing all necessary testing for the customer's applications and products using NXP Semiconductors products in order to avoid a default of the applications and the products or of the application or use by customer's third party customer(s). NXP does not accept any liability in this respect.

**Terms and conditions of commercial sale** — NXP Semiconductors products are sold subject to the general terms and conditions of commercial sale, as published at <http://www.nxp.com/profile/terms>, unless otherwise agreed in a valid written individual agreement. In case an individual agreement is concluded only the terms and conditions of the respective agreement shall apply. NXP Semiconductors hereby expressly objects to applying the customer's general terms and conditions with regard to the purchase of NXP Semiconductors products by customer.

**Export control** — This document as well as the item(s) described herein may be subject to export control regulations. Export might require a prior authorization from competent authorities.

**Suitability for use in non-automotive qualified products** — Unless this data sheet expressly states that this specific NXP Semiconductors product is automotive qualified, the product is not suitable for automotive use. It is neither qualified nor tested in accordance with automotive testing or application requirements. NXP Semiconductors accepts no liability for inclusion and/or use of non-automotive qualified products in automotive equipment or applications.

In the event that customer uses the product for design-in and use in automotive applications to automotive specifications and standards, customer (a) shall use the product without NXP Semiconductors' warranty of the product for such automotive applications, use and specifications, and (b) whenever customer uses the product for automotive applications beyond NXP Semiconductors' specifications such use shall be solely at customer's own risk, and (c) customer fully indemnifies NXP Semiconductors for any liability, damages or failed product claims resulting from customer design and use of the product for automotive applications beyond NXP Semiconductors' standard warranty and NXP Semiconductors' product specifications.

**Translations** — A non-English (translated) version of a document, including the legal information in that document, is for reference only. The English version shall prevail in case of any discrepancy between the translated and English versions.

**Security** — Customer understands that all NXP products may be subject to unidentified vulnerabilities or may support established security standards or specifications with known limitations. Customer is responsible for the design and operation of its applications and products throughout their lifecycles to reduce the effect of these vulnerabilities on customer's applications and products. Customer's responsibility also extends to other open and/or proprietary technologies supported by NXP products for use in customer's applications. NXP accepts no liability for any vulnerability. Customer should regularly check security updates from NXP and follow up appropriately. Customer shall select products with security features that best meet rules, regulations, and standards of the intended application and make the ultimate design decisions regarding its products and is solely responsible for compliance with all legal, regulatory, and security related requirements concerning its products, regardless of any information or support that may be provided by NXP.

NXP has a Product Security Incident Response Team (PSIRT) (reachable at [PSIRT@nxp.com](mailto:PSIRT@nxp.com)) that manages the investigation, reporting, and solution release to security vulnerabilities of NXP products.

### 10.3 Trademarks

Notice: All referenced brands, product names, service names, and trademarks are the property of their respective owners.

**NXP** — wordmark and logo are trademarks of NXP B.V.



## Tables

Tab. 1.	Pin chart of Arduino connectors and their usage ..... 8	Tab. 6.	The secondary tabs under the Stop Watch main tab ..... 21
Tab. 2.	J38 pin chart ..... 9	Tab. 7.	The secondary tabs under Configuration main tab ..... 23
Tab. 3.	PCF85263ATL-ARD jumpers ..... 9	Tab. 8.	The secondary tabs under the Misc main tab ..... 28
Tab. 4.	PCF85263ATL-ARD test points ..... 10	Tab. 9.	Abbreviations ..... 30
Tab. 5.	The secondary tabs under the Real Time Clock main tab ..... 19		

## Figures

Fig. 1.	The PCF85263ATL-ARD board picture, top view (up) and bottom view (down) ..... 7	Fig. 14.	Graphical interface – “Stop Watch” / “Time” tab activated ..... 22
Fig. 2.	PCF85263ATL-ARD Jumper locations ..... 10	Fig. 15.	Graphical interface – “Stop Watch” / “Alarm” tab activated ..... 22
Fig. 3.	PCF85263ATL-ARD daughterboard and IMXRT1050 EVK board, before starting ..... 12	Fig. 16.	Graphical interface – “Stop Watch” / “Timestamps” tab activated ..... 23
Fig. 4.	The assembly PCF85263ATL-ARD daughterboard / IMXRT1050 EVK board operation ..... 13	Fig. 17.	Graphical interface – “Stop Watch” / “Timestamp mode” tab activated ..... 23
Fig. 5.	PCF85263ATL-ARD daughterboard and LPCXpresso55S69 motherboard, before starting ..... 14	Fig. 18.	Graphical interface – “Configuration” / “Oscillator/Clock” tab activated ..... 24
Fig. 6.	PCF85263ATL-ARD daughterboard / LPCXpresso55S69 motherboard operation ..... 15	Fig. 19.	Graphical interface – “Configuration” / “Pin I/O” tab activated ..... 25
Fig. 7.	The assembly PCF85263ATL-ARD daughterboard, IMX8MMINI-IARD interposer board, and i.MX 8M Mini LPDDR4 EVK, before starting ..... 16	Fig. 20.	Graphical interface – “Configuration” / “Battery Switch” tab activated ..... 25
Fig. 8.	PC85263ATL-ARD daughterboard / i.MX 8M Mini LPDDR4 EVK board operation ..... 17	Fig. 21.	Graphical interface – “Configuration” / “Function” tab activated ..... 26
Fig. 9.	Graphical interface at start-up (“Settings” tab activated by default) ..... 18	Fig. 22.	Graphical interface – “Configuration” / “Offset” tab activated ..... 26
Fig. 10.	Graphical interface – “Real Time Clock” / “Time” tab activated ..... 19	Fig. 23.	Graphical interface – “Configuration” / “Interrupts” tab activated ..... 27
Fig. 11.	Graphical interface – “Real Time Clock” / “Alarm” tab activated ..... 20	Fig. 24.	Graphical interface – “Configuration” / “Flags” tab activated ..... 27
Fig. 12.	Graphical interface – “Real Time Clock” / “Timestamps” tab activated ..... 20	Fig. 25.	Graphical interface – “Configuration” / “Reset/Stop Enable” tab activated ..... 28
Fig. 13.	Graphical interface – “Real Time Clock” / “Timestamp Mode” tab activated ..... 21	Fig. 26.	Graphical interface – “Misc” / “RAM BYTE” tab activated ..... 28
		Fig. 27.	Graphical interface – “Misc” / “WatchDog” tab activated ..... 29

---

## Contents

---

<b>1</b>	<b>Introduction</b> .....	<b>4</b>
<b>2</b>	<b>Finding kit resources and information on the NXP web site</b> .....	<b>4</b>
2.1	Collaborate in the NXP community .....	4
<b>3</b>	<b>Getting ready</b> .....	<b>4</b>
3.1	Kit contents .....	4
3.2	Assumptions .....	4
3.3	Static handling requirements .....	5
3.4	Minimum system requirements .....	5
<b>4</b>	<b>Getting to know the hardware</b> .....	<b>5</b>
4.1	PCF85263ATL-ARD features .....	5
4.2	Kit featured components .....	5
4.3	Schematic diagram .....	7
4.4	Arduino port .....	8
4.5	I2C external connector (J38) .....	9
4.6	Jumpers and test points .....	9
<b>5</b>	<b>Installing and configuring software tools</b> .....	<b>10</b>
<b>6</b>	<b>Configuring the hardware</b> .....	<b>11</b>
6.1	Using the PCF85263ATL-ARD with an IMXRT1050 EVK board .....	11
6.2	Using the PCF85263ATL-ARD with an LPCXpresso55S69 development board .....	13
6.3	Using the PCF85263ATL-ARD with an i.MX 8M Mini LPDDR4 EVK board .....	15
6.4	Using PCF85263ATL-ARD with another device .....	17
<b>7</b>	<b>GUI description</b> .....	<b>17</b>
<b>8</b>	<b>Abbreviations</b> .....	<b>30</b>
<b>9</b>	<b>References</b> .....	<b>31</b>
<b>10</b>	<b>Legal information</b> .....	<b>32</b>

---

Please be aware that important notices concerning this document and the product(s) described herein, have been included in section 'Legal information'.

---

© NXP B.V. 2022.

All rights reserved.

For more information, please visit: <http://www.nxp.com>

For sales office addresses, please send an email to: [salesaddresses@nxp.com](mailto:salesaddresses@nxp.com)

Date of release: 17 February 2022  
Document identifier: UM11714