



PXIe-AI5100 Bundle

Expandable PXI bundle based on PXIe-4309
Nanovolt Meter, 32 Ch, 28 Bit, 2MS/s

Specifications

PXIe-1083 and PXIe-4309

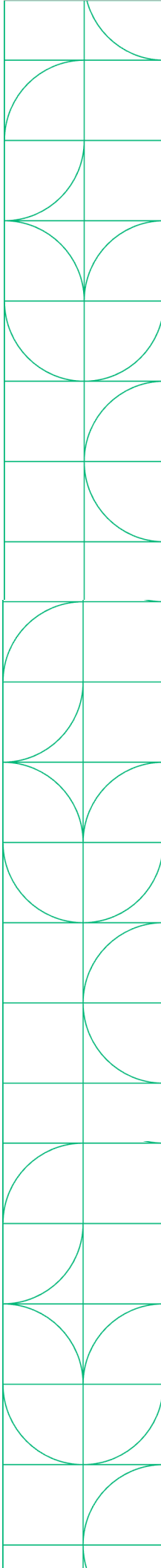

PXI AI Bundle

In the Box

 <p>PXIe-4309 Analog Input</p>	 <p>PXIe-1083 (5-Slot PXIe Chassis)</p>	<p>Accessories:</p> <ul style="list-style-type: none">• TB-4309 Front-mounted Terminal Block• Thunderbolt cable• Power cable (varied by PN)<ul style="list-style-type: none">○ 867125-01 (US)○ 867125-02 (EUR)○ 867125-03 (Generic)
--	---	--

Recommended Software

<p>Test Workflow P/N: 788509-35</p> 	<p>Test Workflow is a bundle of select NI software featuring engineering-specific tools that help test professionals accomplish anything from their day-to-day work to overcoming their most challenging obstacles.</p> <p>Test Workflow includes:</p> <ul style="list-style-type: none">• LabVIEW - a graphical programming environment engineers use to develop automated research, validation, and production test systems.• InstrumentStudio - an application software that provides an integrated approach to interactive PXI measurements.• TestStand - a test executive software that accelerates system development and deployment for engineers in validation and production.• And more NI Software!
--	---

Table of Contents

This document combines the PDFs of this bundle together. The page numbers in the table of contents correspond to the page number of PDF the component's documentation begins.

PXIe-1083 Specifications.....	3
PXIe-4309 Specifications.....	16



PXIe-1083

Specifications



PXIe-1083 Specifications

This document contains specifications for the PXIe-1083 chassis.

Electrical

The following section provides information about the PXIe-1083 AC input and DC output.

AC Input

Input rating	100 VAC to 240 VAC, 50 Hz/60 Hz, 6 A to 3 A
Operating voltage range ¹	90 VAC to 264 VAC
Nominal input frequency	50 Hz/60 Hz
Operating frequency range ¹	47 Hz to 63 Hz
Efficiency	78% typical
Over-current protection	Internal fuse in line
Main power disconnect	The AC power cable provides main power disconnect. Do not position the equipment so that it is difficult to disconnect the power cord. The front-panel power switch causes the internal chassis power supply to provide DC power to the PXI Express backplane.



Caution Disconnect power cord to completely remove power.

DC Output

DC output characteristics of the PXIe-1083.

Voltage Rail	Maximum Current	Load Regulation	Maximum Ripple and Noise (20 MHz BW)
+5V_AUX	1.0 A	±5%	50 mVpp
+12 V	30.1 A	±5%	120 mVpp
+5 V	25.1 A	±5%	50 mVpp
+3.3 V	30.7 A	±5%	50 mVpp
-12 V	0.75 A	±5%	120 mVpp

Maximum total available power for the PXIe-1083 is 293 W.

The maximum combined power available on +3.3 V and +5 V is 180 W.

The maximum power available for each Thunderbolt port is 15 W (5 V/3 A).

Table 1. Backplane Slot Current Capacity

Slot	+5 V	V (I/O)	+3.3 V	+12 V	-12 V	5 V _{AUX}
Hybrid Peripheral Slot with PXI-5 Peripheral	-	-	3 A	6 A	-	1 A
Hybrid Peripheral Slot with PXI-1 Peripheral	6 A	5 A	6 A	1 A	1 A	-



Note PCI V(I/O) pins in Hybrid Peripheral Slots are connected to +5 V.



Note The maximum power dissipated in a peripheral slot should not exceed 58 W. Refer to the **Operating Environment** section for ambient temperature considerations at 58 W.

Over-current protection	All outputs are protected from short circuit and overload, they recover and return to regulation when the overload is removed and the power is cycled.
Over-voltage protection	+3.3 V clamped at 3.7 V to 4.3 V, +5 V clamped at 5.7 V to 6.5 V, +12 V clamped at 13.4 V to 15.6 V

Chassis Cooling

Module cooling	Forced air circulation (positive pressurization) through one 150 CFM fan
Module slot airflow direction	Bottom of module to top of module
Module intake	Bottom of chassis
Module exhaust	Top, right side of chassis
Slot cooling capacity	58 W; slot 6 supports 58 W cooling with high fan mode
Power supply cooling	Forced air circulation through integrated fans
Power supply intake	Front and left side chassis
Power supply exhaust	Rear of chassis
Minimum chassis cooling clearances	
Above	44.45 mm (1.75 in.)
Rear	44.45 mm (1.75 in.)
Sides	44.45 mm (1.75 in.)
Below	
Rack	44.45 mm (1.75 in.)
Desktop	25.4 mm (1.00 in.)

Environmental

Maximum altitude	2,000 m (6,560 ft.), 800 mbar (at 25 °C ambient, high fan mode)
Pollution Degree	2

Indoor use only.

Operating Environment

<p>Ambient temperature range</p> <p>When all peripheral modules require ≤ 38 W cooling capacity per slot</p> <p>0 °C to 50 °C (IEC 60068-2-1 and IEC 60068-2-2.)² Meets MIL-PRF-28800F Class 3 low temperature limit and high temperature limit.</p> <p>When any peripheral module requires > 38 W cooling capacity per slot</p> <p>0 °C to 40 °C (IEC 60068-2-1 and IEC 60068-2-2.)² Meets MIL-PRF-28800F Class 3 low temperature limit and MIL-PRF-28800F Class 4 high temperature limit.</p>	
Relative humidity range	20% to 80%, noncondensing

Storage Environment

Ambient temperature range	-40 °C to 71 °C (IEC-60068-2-1 and IEC-60068-2-2.) ^[3] Meets MIL-PRF-28800F Class 3 limits.
Relative humidity range	10% to 95%, noncondensing

Shock and Vibration

Operational shock	30 g peak, half-sine, 11 ms pulse (IEC-60068-2-27.) ³ Meets MIL-PRF-28800F Class 2 limits.
Operational random vibration	5 to 500 Hz, 0.3 g _{rms}
Non-operating vibration	5 to 500 Hz, 2.4 g _{rms} (IEC 60068-2-64.) ³ Non-operating test profile exceeds the requirements of MIL-PRF-28800F, Class 3.

Acoustic Emissions

Sound Pressure Level (at Operator Position)

(Tested in accordance with ISO 7779. Meets MIL-PRF-28800F requirements.)

38 W Profile

Auto fan (up to 30 °C ambient)	33.7 dBA
High fan	50.8 dBA

58 W Profile

Auto fan (up to 30 °C ambient)	54.7 dBA
High fan	55.3 dBA

Sound Power Level

38 W Profile

Auto fan (up to 30 °C ambient)	44.9 dBA
High fan	60.3 dBA

58 W Profile

Auto fan (up to 30 °C ambient)	63.4 dBA
High fan	64.2 dBA



Note The protection provided by the PXIe-1083 can be impaired if it is used in a manner not described in this document.

Safety Compliance Standards

This product is designed to meet the requirements of the following electrical equipment safety standards for measurement, control, and laboratory use:

- IEC 61010-1, EN 61010-1
- UL 61010-1, CSA C22.2 No. 61010-1



Note For safety certifications, refer to the product label or the [Product Certifications and Declarations](#) section.

EMC Guidelines

This product was tested and complies with the regulatory requirements and limits for electromagnetic compatibility (EMC) stated in the product specifications. These requirements and limits provide reasonable protection against harmful interference when the product is operated in the intended operational electromagnetic environment.

This product is intended for use in industrial locations. However, harmful interference may occur in some installations, when the product is connected to a peripheral device or test object, or if the product is used in residential areas. To minimize interference with radio and television reception and prevent unacceptable performance degradation, install and use this product in strict accordance with the instructions in the product documentation.

Furthermore, any changes or modifications to the product not expressly approved by NI could void your authority to operate it under your local regulatory rules.

EMC Notices

Refer to the following notices for cables, accessories, and prevention measures necessary to ensure the specified EMC performance.



Notice

For EMC declarations and certifications, and additional information, refer to the [Product Certifications and Declarations](#) section.



Notice Changes or modifications to the product not expressly approved by NI could void your authority to operate the product under your local regulatory rules.



Notice Operate this product only with shielded cables and accessories.

Electromagnetic Compatibility Standards

This product meets the requirements of the following EMC standards for electrical equipment for measurement, control, and laboratory use:

- EN 61326-1 (IEC 61326-1): Class A emissions; Basic immunity
- EN 55011 (CISPR 11): Group 1, Class A emissions

- AS/NZS CISPR 11: Group 1, Class A emissions



Note Group 1 equipment (per CISPR 11) is any industrial, scientific, or medical equipment that does not intentionally generate radio frequency energy for the treatment of material or inspection/analysis purposes.



Note In Europe, Canada, Australia, and New Zealand (per CISPR 11) Class A equipment is intended for use in nonresidential locations.

CE Compliance

This product meets the essential requirements of applicable European Directives, as follows:

- 2014/35/EU; Low-Voltage Directive (safety)
- 2014/30/EU; Electromagnetic Compatibility Directive (EMC)
- 2011/65/EU; Restriction of Hazardous Substances (RoHS)

Product Certifications and Declarations

Refer to the product Declaration of Conformity (DoC) for additional regulatory compliance information. To obtain product certifications and the DoC for NI products, visit ni.com/product-certifications, search by model number, and click the appropriate link.

Environmental Management

NI is committed to designing and manufacturing products in an environmentally responsible manner. NI recognizes that eliminating certain hazardous substances from our products is beneficial to the environment and to NI customers.

For additional environmental information, refer to the **Engineering a Healthy Planet** web page at ni.com/environment. This page contains the environmental

regulations and directives with which NI complies, as well as other environmental information not included in this document.

EU and UK Customers

-  Waste Electrical and Electronic Equipment (WEEE)—At the end of the product life cycle, all NI products must be disposed of according to local laws and regulations. For more information about how to recycle NI products in your region, visit ni.com/environment/weee.

电子信息产品污染控制管理办法 (中国 RoHS)

-  中国 RoHS— NI 符合中国电子信息产品中限制使用某些有害物质指令(RoHS)。关于 NI 中国 RoHS 合规性信息，请登录 ni.com/environment/rohs_china。(For information about China RoHS compliance, go to ni.com/environment/rohs_china.)

Backplane

Size	3U-sized; 5 peripheral slots. Compliant with IEEE 1101.10 mechanical packaging. PXI Express Specification compliant. Accepts both PXI Express and CompactPCI (PICMG 2.0 R 3.0) 3U modules.
Backplane bare-board material	UL 94 V-0 Recognized
Backplane connectors	Conforms to IEC 917 and IEC 1076-4-101, UL 94 V-0 rated

System Synchronization Clocks

10 MHz System Reference Clock: PXI_CLK10

Maximum slot-to-slot skew	250 ps
Accuracy	± 25 ppm max (guaranteed over the operating temperature range)
Maximum jitter	5 ps RMS phase-jitter (10 Hz–1 MHz range)
Duty-factor	45% to 55%
Unloaded signal swing	3.3 V \pm 0.3 V



Note For other specifications, refer to the **PXI-1 Hardware Specification**.

100 MHz System Reference Clock: PXIe_CLK100 and PXIe_SYNC100

Maximum slot-to-slot skew	100 ps
Accuracy	± 25 ppm max (guaranteed over the operating temperature range)
Maximum jitter	3 ps RMS phase-jitter (10 Hz to 12 kHz range), 2 ps RMS phase-jitter (12 kHz to 20 MHz range)
Duty-factor for PXIe_CLK100	45% to 55%
Absolute differential voltage (When terminated with a 50 Ω load to 1.30 V or Thévenin equivalent)	400 mV to 1000 mV



Note For other specifications, refer to the **PXI-5 PXI Express Hardware Specification**.

Mechanical

Standard chassis dimensions	
Height	177.1 mm (6.97 in.)
Width	257.1 mm (10.12 in.)
Depth	214.2 mm (8.43 in.)
Weight	6.7 kg (14.8 lb)
Chassis materials	Extruded Aluminum (6063-T5, 6060-T6), Cold Rolled Steel/Stainless Steel, Santoprene, Urethane Foam, PC-ABS, Nylon, Polyethylene
Finish	Conductive Clear Iridite on Aluminum, Electroplated Nickel on Cold Rolled Steel, Electroplated Zinc on Cold Rolled Steel

The following figures show the PXIe-1083 chassis dimensions. The holes shown are for installing the optional rack mount kits.

Figure 1. PXIe-1083 Chassis Dimensions (Front)

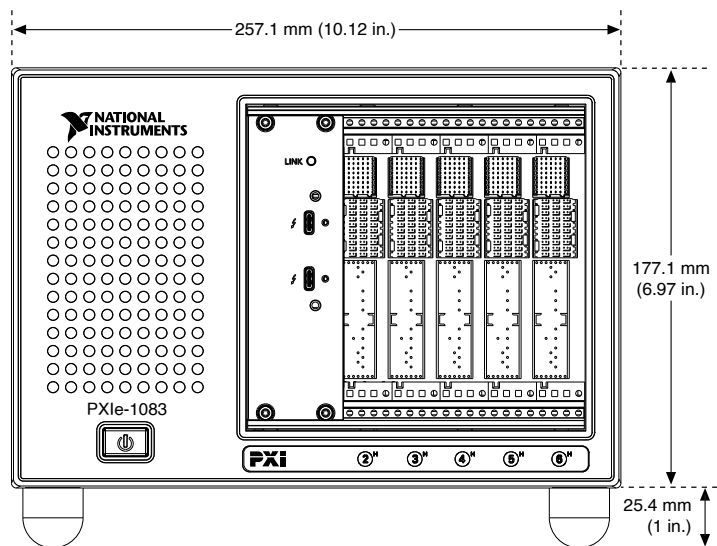

Figure 2. PXIe-1083 Chassis Dimensions (Side)

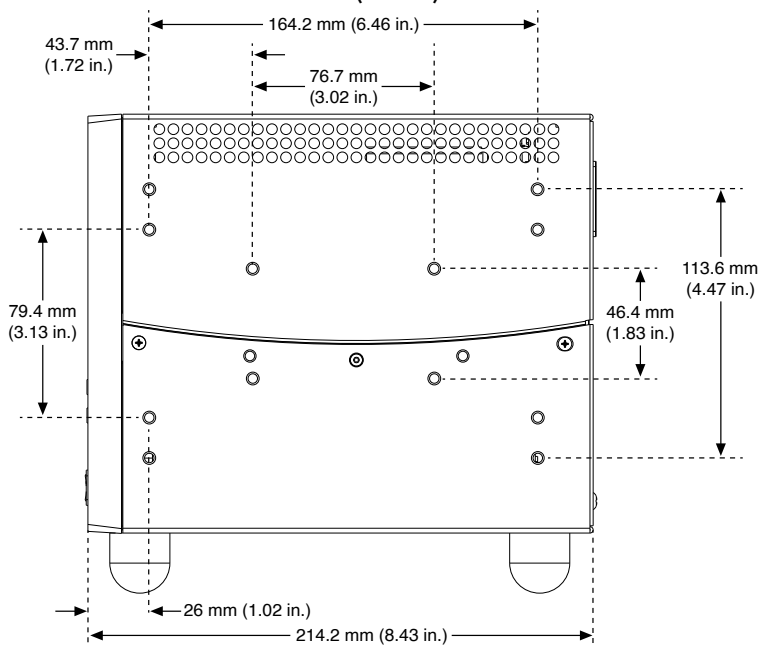
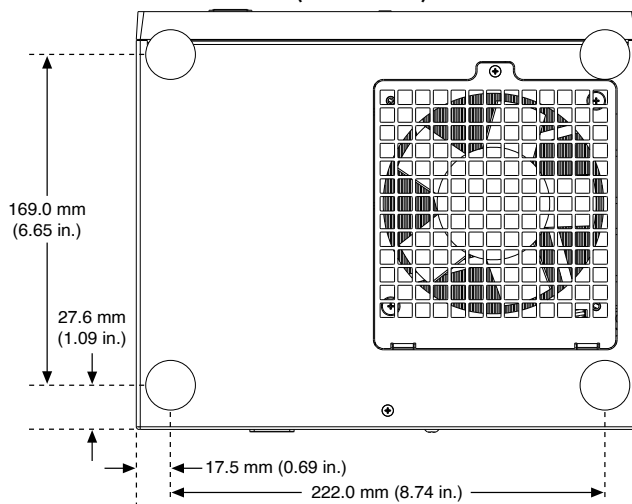

Figure 3. PXIe-1083 Chassis Dimensions (Bottom)



¹ The operating range is guaranteed by design.

² This product meets the requirements of the environmental standards for electrical equipment for measurement, control, and laboratory use.

³ This product meets the requirements of the environmental standards for electrical equipment for measurement, control, and laboratory use.

PXle-4309 Specifications

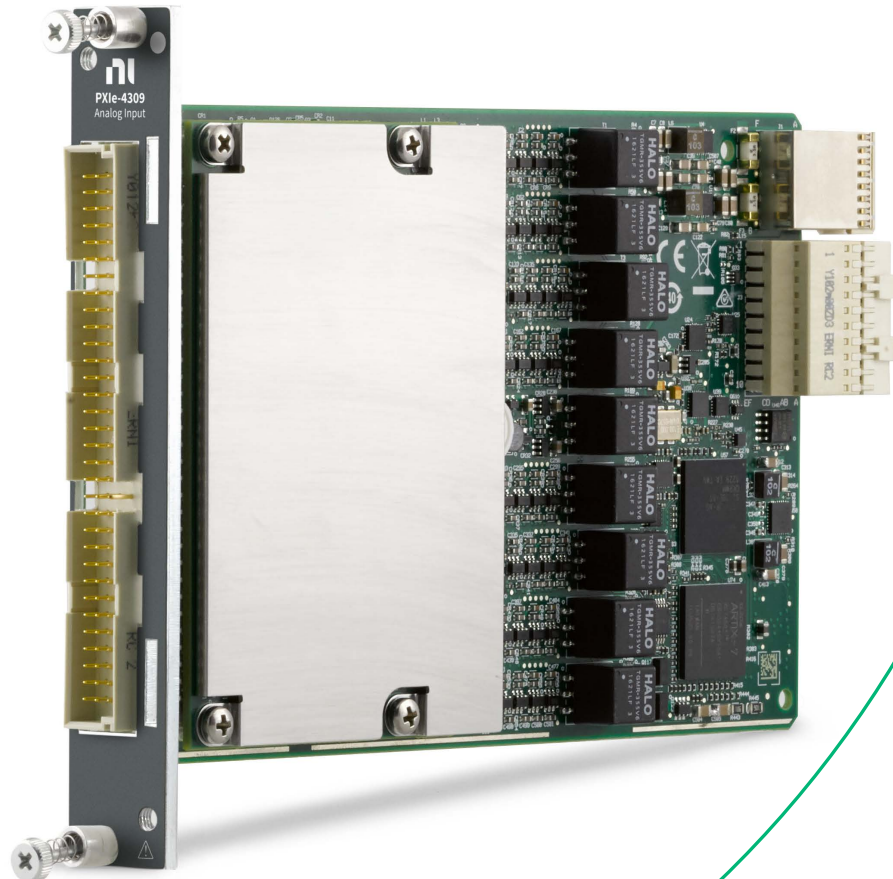

SPECIFICATIONS

PXIe-4309

32 Ch (8 ADC), 2 MS/s, 18 - 28 bit, Flexible Resolution PXI Analog Input Module

[Français](#) [Deutsch](#) [日本語](#) [한국어](#) [简体中文](#)

ni.com/manuals

This document lists specifications for the PXIe-4309 data acquisition module. All specifications are subject to change without notice. Refer to ni.com/manuals for the most current specifications and product documentation.



Note To maintain forced air cooling in the PXIe system, refer to the *Maintain Forced-Air Cooling Note to Users*.

Terminology

Maximum and *minimum* specifications characterize the warranted performance of the instrument within the recommended calibration interval and under the stated operating conditions. These specifications are subject to production verification or guaranteed by design.

Typical specifications are specifications met by the majority of the instruments within the recommended calibration interval and under the stated operating conditions, based on measurements taken during production verification and/or engineering development. The performance of the instrument is not warranted.

Supplemental specifications describe the basic function and attributes of the instrument established by design and are not subject to production verification. They provide information that is relevant for the adequate use of the instrument that is not included in the previous definitions.

The following specifications are typical at 25 °C, unless otherwise noted.

- T_{extcal} is the device temperature at last external calibration.
- $T_{selfcal}$ is the device temperature at last self-calibration.

Input Characteristics

Number of ADCs	8 simultaneously sampling ADCs
Number of channels	
Single channel per ADC	8 differential analog input channels
Multichannel per ADC ¹	32 differential analog input channels
ADC resolution.....	18 bits
Type of ADC	SAR
DNL.....	No missing codes
INL	Refer to Absolute Accuracy section
Measurement resolution ²	18 bits - 28 bits
Maximum sample rate ^{3, 4}	
Auto zero none	
Single channel per ADC	2 MS/s
Multichannel per ADC	400 kS/s (aggregate)
Auto zero once	
Single channel per ADC	2 MS/s
Multichannel per ADC	400 kS/s (aggregate)
Auto zero every sample	
Single channel per ADC.....	10 kS/s
Multichannel per ADC	10 kS/s (aggregate)
Chopping	
Single channel per ADC.....	10 kS/s
Multichannel per ADC	10 kS/s (aggregate)
Input coupling	DC
Input range.....	±0.1 V, ±1.0 V, ±10 V, ±15 V
Input overrange	0.5% of range
Maximum working voltage (signal + common mode)	±15.5 V of GND

¹ Up to 4 channels per ADC.

² Depends on the sample rate. Refer to the [Noise versus Sampling Rate](#) section for more information.

³ For multichannel, up to 4 channels per ADC.

⁴ Refer to the [PXIe-4309 User Manual](#) for Maximum Sample Rates in Hardware-Timed Single Point, On-Demand, and External Sample Clock modes.

Input impedance

Device on, channel idle

AI+ to AI- >10 G Ω in parallel with 100 pF

AI- to GND..... >100 G Ω in parallel with 10 pF

Device on, channel active

AI+ to AI- >10 G Ω in parallel with 200 pF

AI- to GND..... >100 G Ω in parallel with 100 pF

Input bias current

Device on, channel active ± 4.5 nA

Overvoltage protection

Device on/off..... ± 30 V min

Overvoltage protection input current

Device on ± 100 μ A

Device off..... ± 10 μ A

FIFO buffer size..... 1,023 samples

Data transfers..... Direct memory access (DMA),
programmed I/O

Absolute Accuracy

Auto Zero None

Table 1. DC Voltage Specifications for Auto Zero None

Range	Absolute Accuracy ^{*, **, ††}			Temperature Coefficient ^{††}
	24 Hour ^{†, ‡} T _{extcal} ± 1 °C T _{selfcal} ± 1 °C	2 Year T _{extcal} ± 5 °C T _{selfcal} ± 1 °C	2 Year T _{extcal} ± 10 °C T _{selfcal} ± 5 °C	0 °C - 55 °C
Range	± (ppm of reading + μV)			± (ppm of reading + μV) / °C
0.1 V	33 + 3.2	60 + 7.6	165 + 11.6	25 + 1
1.0 V	28 + 7.4	55 + 16.2	140 + 36.2	20 + 5
10 V	23 + 59.6	50 + 155	115 + 355	15 + 50
15 V	28 + 89.0	55 + 307	140 + 607	20 + 75

^{*}Source Impedance ≤50 Ω.
[†]Relative to External Calibration Source.
[‡]Assumes Offset Nulling.
^{**}Sample Rate ≤10 S/s.
^{††}Temperature Coefficient is an adder to the Absolute Accuracy values that does not apply unless operating outside of the stated self-calibration temperature intervals. Temperature Coefficient is included in the Absolute Accuracy values over the stated self-calibration temperature intervals.

Table 2. DC Voltage Performance Specifications for Auto Zero None

Range	Residual Offset ^{†, ‡} μV	Linearity [†] ppm of range	Noise ^{*, †, ‡}		
			10 S/s μV _{pk-pk}	10 kS/s	2 MS/s μV _{rms}
0.1 V	5	5	2.2	0.6	6.9
1.0 V			2.4	0.8	11
10 V			9.6	5.8	84
15 V	75	10	14	8.7	125

^{*}Source Impedance ≤50 Ω.
[†]Residual Offset, Linearity and Noise are included in the Absolute Accuracy values in the DC voltage specifications table for Sample Rate ≤10 S/s.
[‡]Noise for Single Channel per ADC. For Multiple Channel per ADC refer to the [Noise versus Sampling Rate](#) section.

Auto Zero Once

Table 3. DC Voltage Specifications for Auto Zero Once

Range	Absolute Accuracy ^{*, **, ††}			Temperature Coefficient ^{††}
	24 Hour ^{†, ‡} T _{extcal} ± 1 °C T _{selfcal} ± 1 °C	2 Year T _{extcal} ± 5 °C T _{selfcal} ± 1 °C	2 Year T _{extcal} ± 10 °C T _{selfcal} ± 5 °C	0 °C - 55 °C
	± (ppm of reading + μV)			± (ppm of reading + μV) / °C
0.1 V	33 + 2.3	60 + 6.7	165 + 7.1	25 + 0.1
1.0 V	28 + 2.5	55 + 11.3	140 + 11.7	20 + 0.1
10 V	23 + 9.7	50 + 104.9	115 + 105.3	15 + 0.1
15 V	28 + 14.1	55 + 232.1	140 + 232.5	20 + 0.1

*Source Impedance ≤50 Ω.
†Relative to External Calibration Source.
‡Assumes Offset Nulling.
**Sample Rate ≤10 S/s.
††Temperature Coefficient is an adder to the Absolute Accuracy values that does not apply unless operating outside of the stated self-calibration temperature intervals. Temperature Coefficient is included in the Absolute Accuracy values over the stated self-calibration temperature intervals.

Table 4. DC Voltage Performance Specifications for Auto Zero Once

Range	Residual Offset ^{*, †}	Linearity [†]	Noise ^{*, †, ‡}		
			10 S/s	10 kS/s	2 MS/s
	μV	ppm of range	μV _{pk-pk}	μV _{rms}	
0.1 V	5	5	2.2	0.6	6.9
1.0 V			2.4	0.8	11
10 V	50	10	9.6	5.8	84
15 V	75		14	8.7	125

*Source Impedance ≤50 Ω.
†Residual Offset, Linearity and Noise are included in the Absolute Accuracy values in the DC voltage specifications table for Sample Rate ≤10 S/s.
‡Noise for Single Channel per ADC. For Multiple Channel per ADC refer to the [Noise versus Sampling Rate](#) section.

Auto Zero Every Sample

Table 5. DC Voltage Specifications for Auto Zero Every Sample

Range	Absolute Accuracy ^{*, **, ††}			Temperature Coefficient ^{††}
	24 Hour ^{†, ‡} T _{extcal} ± 1 °C T _{selfcal} ± 1 °C	2 Year T _{extcal} ± 5 °C T _{selfcal} ± 1 °C	2 Year T _{extcal} ± 10 °C T _{selfcal} ± 5 °C	0 °C - 55 °C
	± (ppm of reading + μV)			
0.1 V	33 + 0.3	60 + 4.7	165 + 5.1	25 + 0.1
1.0 V	28 + 0.5	55 + 9.3	140 + 9.7	20 + 0.1
10 V	23 + 2.7	50 + 55.4	115 + 55.8	15 + 0.1
15 V	28 + 4.0	55 + 156.1	140 + 156.5	20 + 0.1

^{*}Source Impedance ≤50 Ω.
[†]Relative to External Calibration Source.
[‡]Assumes Offset Nulling.
^{**}Sample Rate ≤10 S/s.
^{††}Temperature Coefficient is an adder to the Absolute Accuracy values that does not apply unless operating outside of the stated self-calibration temperature intervals. Temperature Coefficient is included in the Absolute Accuracy values over the stated self-calibration temperature intervals.

Table 6. DC Voltage Performance Specification for Auto Zero Every Sample

Range	Residual Offset ^{*, †}	Linearity [†]	Noise ^{*, †, ‡}	
			10 S/s	10 kS/s
	μV	ppm of range	μV _{pk-pk}	μV _{rms}
0.1 V	4	5	0.2	0.8
1.0 V			0.4	1.1
10 V			2.6	7.4
15 V		10	3.9	11

^{*}Source Impedance ≤50 Ω.
[†]Residual Offset, Linearity and Noise are included in the Absolute Accuracy values in the DC voltage specifications table for Sample Rate ≤10 S/s.
[‡]Noise for Single Channel per ADC. For Multiple Channel per ADC refer to the *Noise versus Sampling Rate* section.

Chopping

Table 7. DC Voltage Specifications for Chopping

Range	Absolute Accuracy ^{*, **, ††}			Temperature Coefficient ^{††}
	24 Hour ^{†, ‡} T _{extcal} ± 1 °C T _{selfcal} ± 1 °C	2 Year T _{extcal} ± 5 °C T _{selfcal} ± 1 °C	2 Year T _{extcal} ± 10 °C T _{selfcal} ± 5 °C	0 °C - 55 °C
	± (ppm of reading + μV)			± (ppm of reading + μV) / °C
0.1 V	33 + 0.1	60 + 2.6	165 + 2.6	25 + 0.01
1.0 V	28 + 0.2	55 + 7.1	140 + 7.2	20 + 0.01
10 V	23 + 1.3	50 + 52.7	115 + 52.7	15 + 0.01
15 V	28 + 2.0	55 + 153.0	140 + 153.1	20 + 0.01

^{*}Source Impedance ≤ 50 Ω.
[†]Relative to External Calibration Source.
[‡]Assumes Offset Nulling.
^{**}Sample Rate ≤ 10 S/s.
^{††}Temperature Coefficient is an adder to the Absolute Accuracy values that does not apply unless operating outside of the stated self-calibration temperature intervals. Temperature Coefficient is included in the Absolute Accuracy values over the stated self-calibration temperature intervals.

Table 8. DC Voltage Performance Specifications for Chopping

Range	Residual Offset ^{*, †}	Linearity [†]	Noise ^{*, †, ‡}	
			10 S/s	10 kS/s
	μV	ppm of range	μV _{pk-pk}	μV _{rms}
0.1 V	2	5	0.1	0.5
1.0 V			0.2	0.8
10 V			1.3	6.2
15 V		10	2	9.2

^{*}Source Impedance ≤ 50 Ω.
[†]Residual Offset, Linearity and Noise are included in the Absolute Accuracy values in the DC voltage specifications table for Sample Rate ≤ 10 S/s.
[‡]Noise for Single Channel per ADC. For Multiple Channel per ADC refer to the [Noise versus Sampling Rate](#) section.

Offset Cancellation Long Term Stability Performance

TB-4309 (ST), analog inputs shorted at the terminal block screw terminals

Continuous Acquisition, 0.1 V Range, Auto Zero Every Sample, 2 S/s

Offset Nulling: 2 samples prior to continuous acquisition

Waveform Filter: Average and Decimate by 720 (10 S/hr)

Figure 1. Auto Zero Every Sample Offset Cancellation Stability

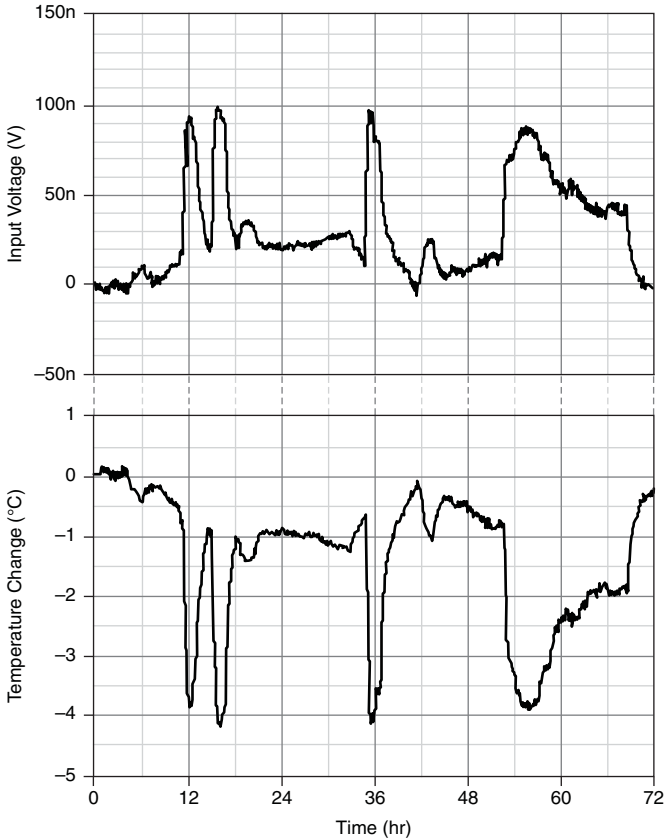

TB-4309 (ST), analog inputs shorted at the terminal block screw terminals
Continuous Acquisition, 0.1 V Range, Chopping, 2 S/s
Offset Nulling: 2 samples prior to continuous acquisition
Waveform Filter: Average and Decimate by 720 (10 S/hr)

Figure 2. Chopping Offset Cancellation Stability

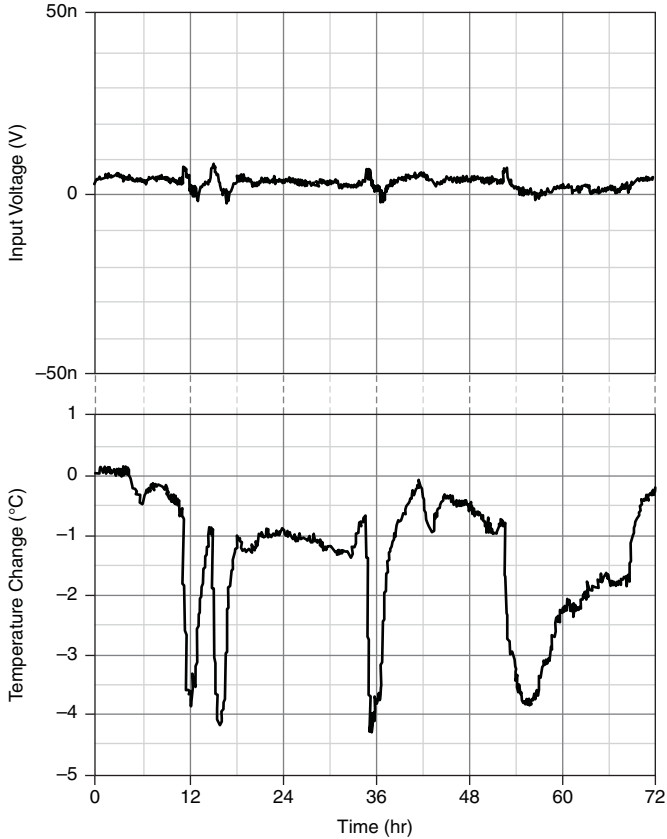

Offset Cancellation Spectral Noise Density Performance

TB-4309 (ST), analog inputs shorted at the terminal block screw terminals
Continuous Acquisition, 0.1 V Range, 518400 Samples acquired at 2 S/s

Figure 3. Offset Cancellation Spectral Noise Density

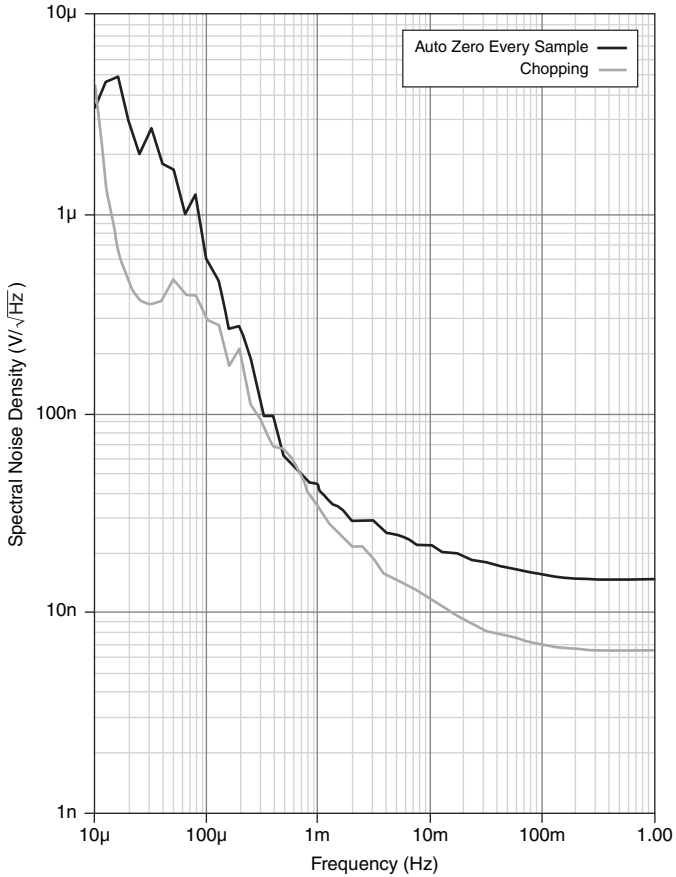

Noise versus Sampling Rate

Auto Zero None and Auto Zero Once

Figure 4. Noise versus Sample Rate (Single channel per ADC)

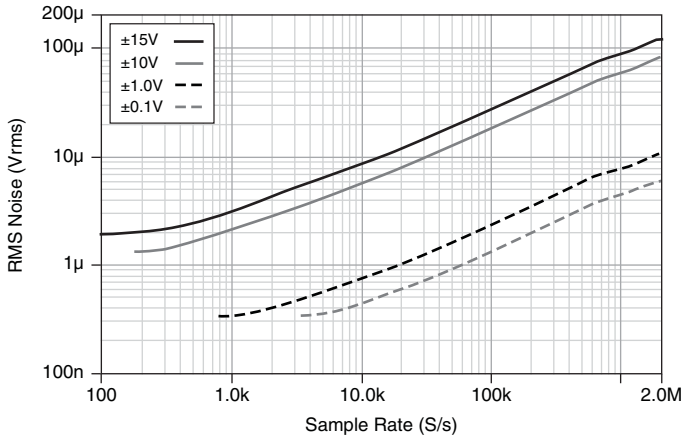
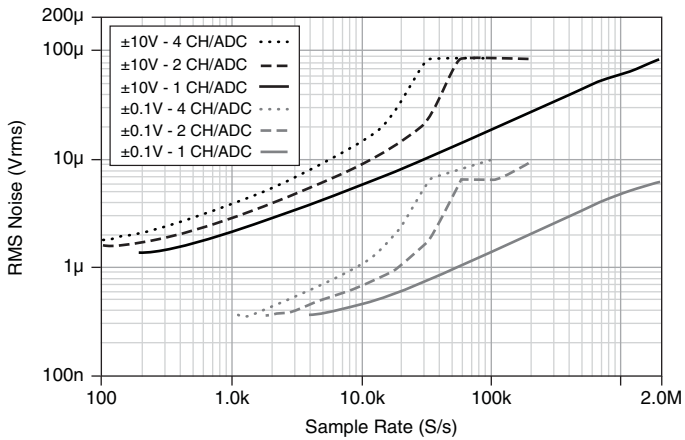

Figure 5. Noise versus Sample Rate (Multichannel per ADC)



Auto Zero Every Sample

Figure 6. Noise versus Sample Rate (Single channel per ADC)

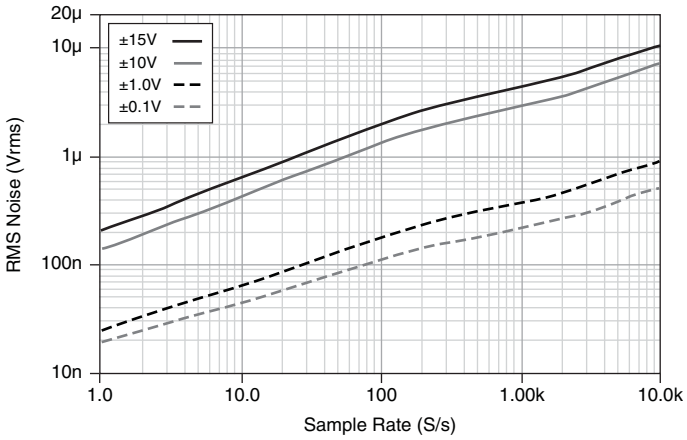
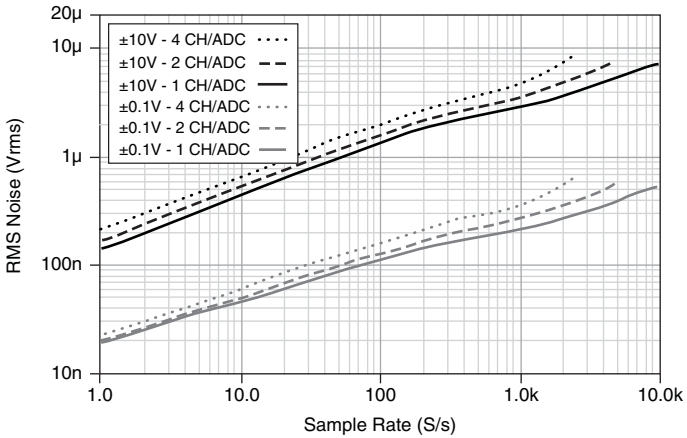

Figure 7. Noise versus Sample Rate (Multichannel per ADC)



Chopping

Figure 8. Noise versus Sample Rate (Single channel per ADC)

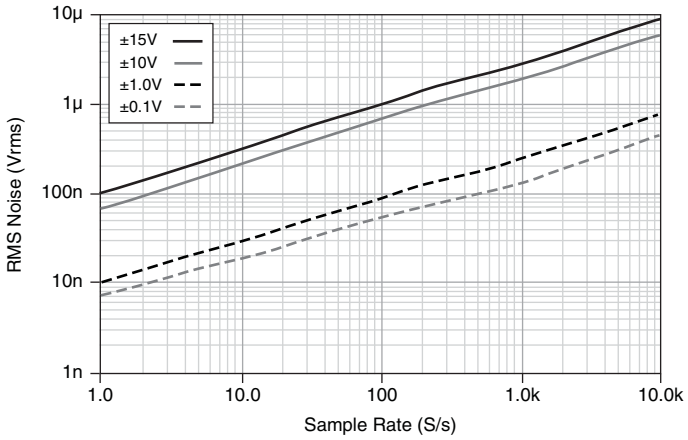
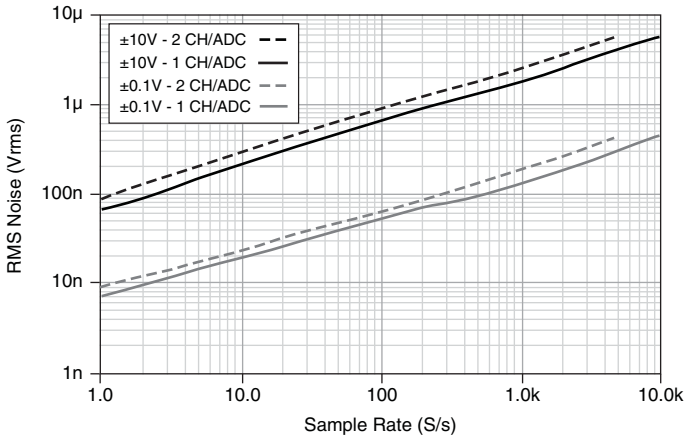
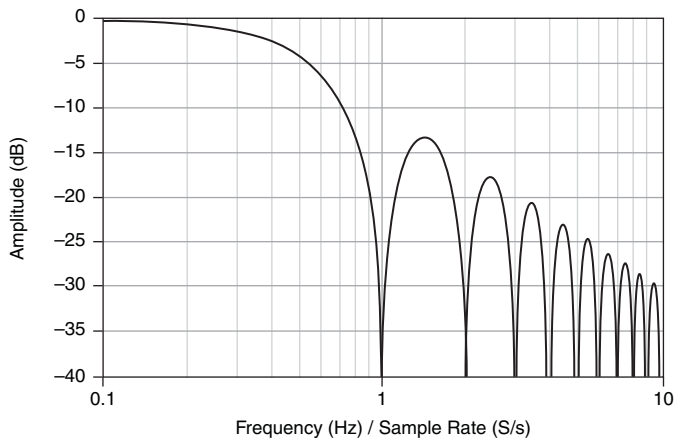

Figure 9. Noise versus Sample Rate (Multichannel per ADC)



Digital Filter Frequency Response^{1, 2, 3}

Figure 10. Digital Filter Frequency Response



¹ Applies to sampling rates ≤ 1 MS/s for all configurations that use a single channel per ADC.

² Applies to sampling rates ≤ 200 kS/s (aggregate) for all configurations that use multiple channels per ADC.

³ Does not apply to Hardware-Timed Single Point, On-Demand, and External Sample Clock modes.

Dynamic Characteristics

Spectral Noise Density

Input voltage noise density at 1 kHz

0.1 V	6.2 nV/ $\sqrt{\text{Hz}}$
1.0 V	12 nV/ $\sqrt{\text{Hz}}$
10 V	94 nV/ $\sqrt{\text{Hz}}$
15 V	136 nV/ $\sqrt{\text{Hz}}$

Input current noise density at 1 kHz..... 0.5 pA/ $\sqrt{\text{Hz}}$

Auto Zero None and Auto Zero Once

Figure 11. 2 MS/s Spectral Noise Density (Single channel per ADC)

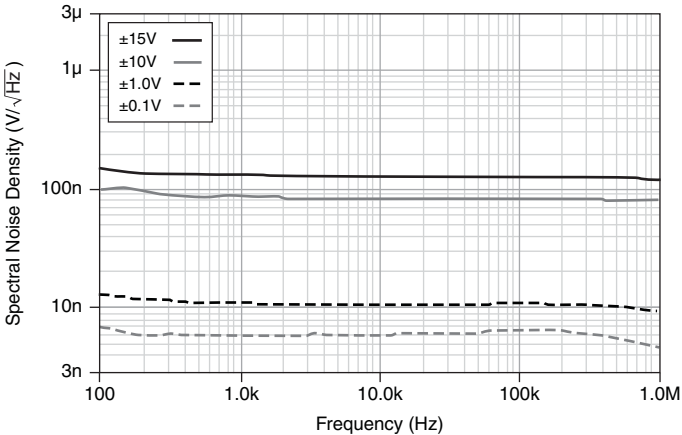

Figure 12. 20 kS/s Spectral Noise Density (Single channel per ADC)

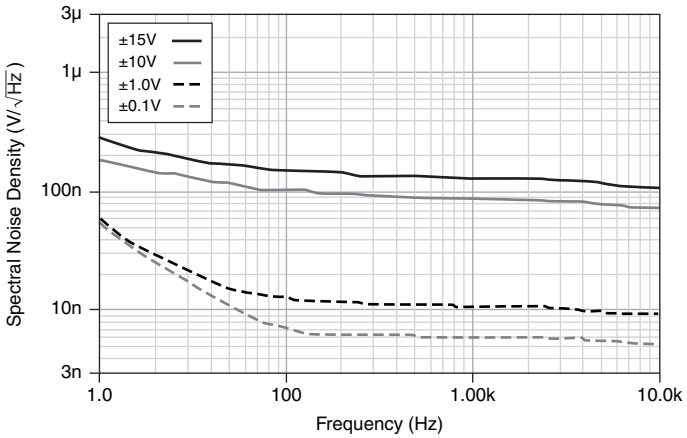

Figure 13. 20 kS/s Spectral Noise Density (Multichannel per ADC)

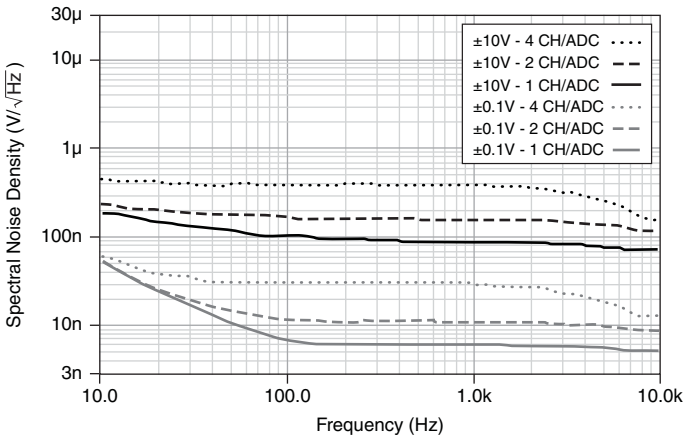

Figure 14. 2 kS/s Spectral Noise Density (Single channel per ADC)

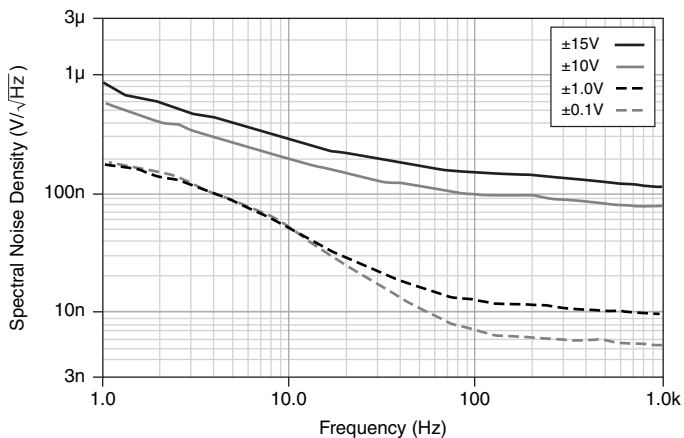
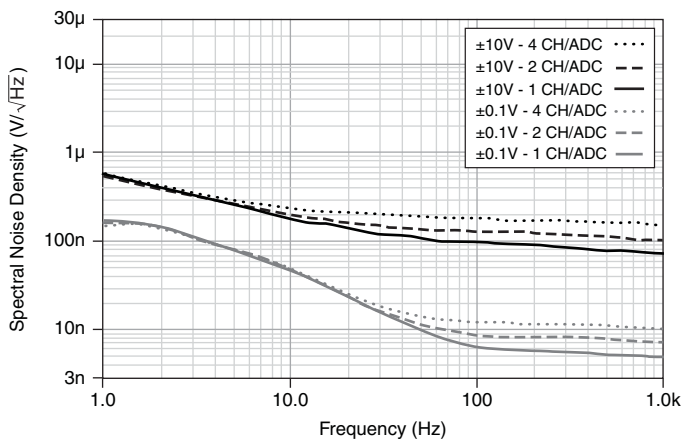

Figure 15. 2 kS/s Spectral Noise Density (Multichannel per ADC)



Auto Zero Every Sample

Figure 16. 2 kS/s Spectral Noise Density (Single channel per ADC)

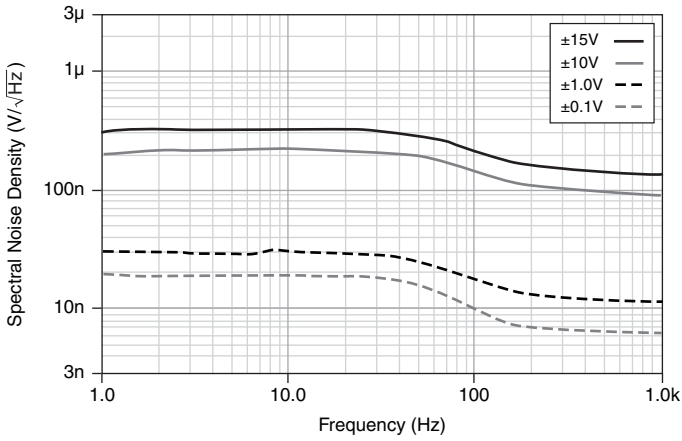
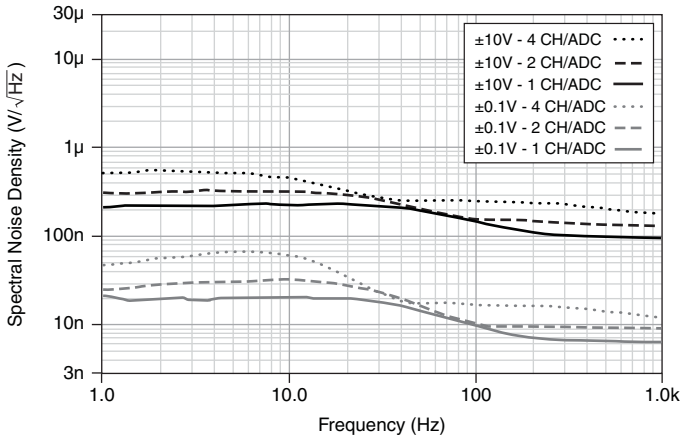

Figure 17. 2 kS/s Spectral Noise Density (Multichannel per ADC)



Chopping

Figure 18. 2 kS/s Spectral Noise Density (Single channel per ADC)

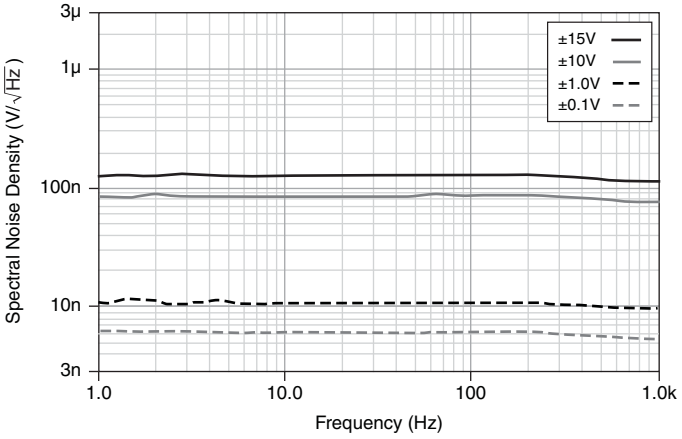
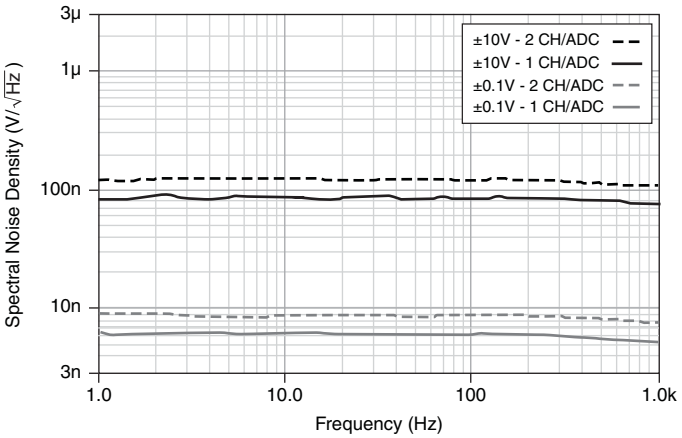

Figure 19. 2 kS/s Spectral Noise Density (Multichannel per ADC)



Common-Mode Rejection Ratio (CMRR)

DC.....	>160 dBc
DC - 100 Hz	
0.1 V, 1.0 V	>126 dBc
10 V.....	>120 dBc
15 V.....	>114 dBc

Figure 20. Common-Mode Rejection Ratio

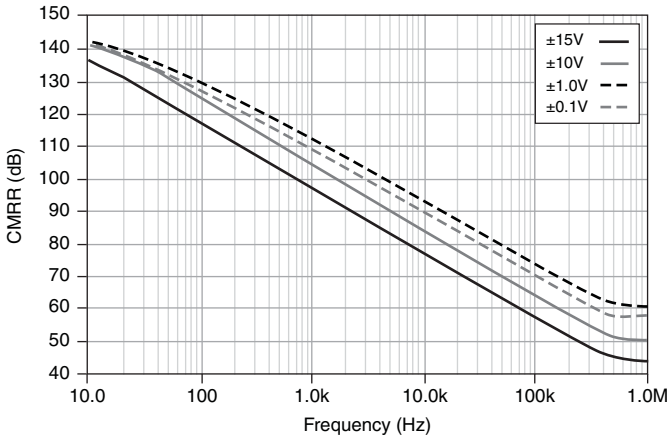

Crosstalk, Input Channel Separation¹

TB-4309 (ST)² and TB-4309 (MT)³

1 kHz.....	Typically ≤ -120 dBc
10 kHz.....	Typically ≤ -100 dBc
100 kHz.....	Typically ≤ -80 dBc
500 kHz.....	Typically ≤ -70 dBc

¹ To maintain crosstalk performance use separation and/or shielding between signal cables.

² Inputs shorted at terminal block screw terminals.

³ Inputs shorted at SCB-68 screw terminals using 2 m, 68-pin cable.

Bandwidth

-3.0 dB bandwidth 500 kHz

Figure 21. Magnitude Response

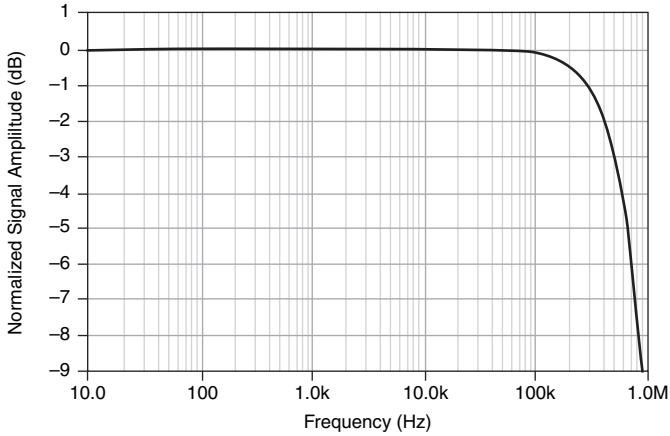

Flatness

DC - 20 kHz -6.5 mdB

DC - 80 kHz -100 mdB

Figure 22. Flatness

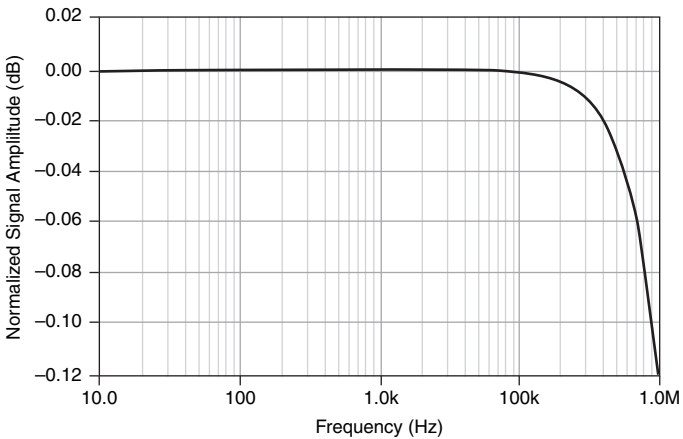

Source Impedance Error

Figure 23. Source Impedance Reading Error¹

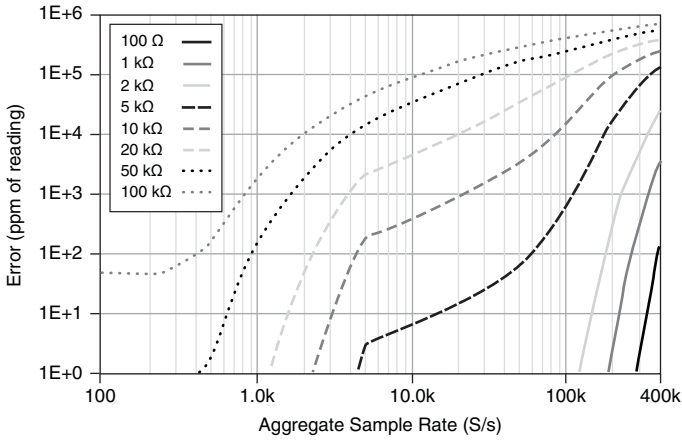
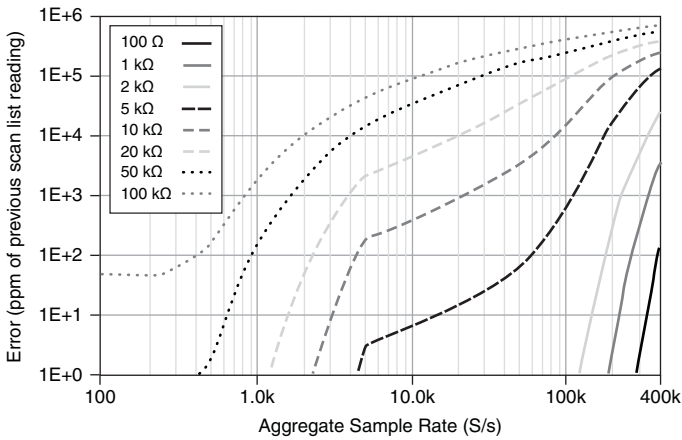

Figure 24. Source Impedance Ghosting Error²



¹ Applies to all configurations that use multiple channels per ADC, Auto Zero Every Sample or Chopping.

² Applies to all configurations that use multiple channels per ADC.

Onboard Calibration Reference

Voltage

Output voltage range	6.741 V – 7.298 V
Output current drive	±1 μ A
Temperature coefficient	±1 ppm/°C
Overvoltage protection	±30 V min

Frequency Timebase Characteristics

Resolution	10 ns
Accuracy	
Using internal timebase	±50 ppm
Using external timebase	Equal to accuracy of external timebase

Timing and Synchronization

Number of timing engines	1
Reference clock source	Onboard clock, backplane PXIe_CLK100

Digital Triggers

Purpose	Start trigger, reference trigger, pause trigger
Source	PFI 0, PFI 1, PXI_Trig <0..7>, PXI_Star, PXIe_DStar A, PXIe_DStar B
Polarity	Software-selectable
Debounce filter settings	Disable, 90 ns, 5.12 μ s, custom interval

Output Timing Signals

Source	Start trigger, reference trigger, pause trigger, sample clock
Destination	PFI 0, PFI 1, PXI_Trig <0..7>, PXIe_DStarC

PFI 0 and PFI 1 (Front Panel Digital Triggers)

Input

Logic compatibility.....	3.3 V or 5 V
High, VIH.....	2.40 V min
Low, VIL.....	0.95 V max
Input impedance.....	10 k Ω
Input current ($0\text{ V} \leq V_{in} \leq 5\text{ V}$).....	$\leq 500\ \mu\text{A}$
Overvoltage protection.....	$\pm 30\text{ V min}$

Output

High, VOH.....	3.43 V max
Sourcing 5 mA.....	2.88 V min
Low, VOL.....	
Sinking 5 mA.....	0.33 V max
Output impedance.....	50 Ω
Output current.....	$\pm 30\text{ mA min}$
Overvoltage protection.....	$\pm 30\text{ V min}$

General Specifications

Bus Interface

Form factor.....	x1 PXI Express peripheral module, specification rev 1.0 compliant
Slot compatibility.....	PXI Express or PXI Express hybrid slots
DMA channels.....	1, analog input

Power Requirements

+12 V.....	2 A max
+3.3 V.....	1 A max

Physical

Dimensions.....	16 cm × 10 cm (6.3 in. × 3.9 in.) 3U CompactPCI slot
Weight	238 g (8.4 oz)
I/O connector.....	96-pin male DIN 41612/IEC 60603-2 connector
Measurement Category ¹	I



Caution Do *not* use the PXIe-4309 for connections to signals or for measurements within Categories II, III, or IV.



Caution The protection provided by the PXIe-4309 can be impaired if it is used in a manner not described in this document.



Caution Clean the hardware with a soft, nonmetallic brush. Make sure that the hardware is completely dry and free from contaminants before returning it to service.

Environmental Specifications

Operating Environment

Ambient temperature range.....	0 °C to 55 °C (Tested in accordance with IEC 60068-2-1 and IEC 60068-2-2. Meets MIL-PRF-28800F Class 3 low temperature limit and MIL-PRF-28800F Class 2 high temperature limit.)
Relative humidity range	10% to 90%, noncondensing (Tested in accordance with IEC 60068-2-56.)
Maximum altitude.....	2,000 m (800 mbar)
Pollution Degree	2

Indoor use only.

¹ Measurement Categories CAT I and CAT O are equivalent. These test and measurement circuits are not intended for direct connections to the MAINS building installations of Measurement Categories CAT II, CAT III, CAT IV.

Storage Environment

Ambient temperature range	-40 °C to 71 °C (Tested in accordance with IEC 60068-2-1 and IEC 60068-2-2. Meets MIL-PRF-28800F Class 3 limits.)
Relative humidity range	5% to 95%, noncondensing (Tested in accordance with IEC 60068-2-56.)

Shock and Vibration

Operating shock.....	30 g peak, half-sine, 11 ms pulse (Tested in accordance with IEC 60068-2-27. Meets MIL-PRF-28800F Class 2 limits.)
Random vibration	
Operating.....	5 Hz to 500 Hz, 0.3 grms
Non-operating.....	5 Hz to 500 Hz, 2.4 grms (Tested in accordance with IEC 60068-2-64. Non-operating test profile exceeds the requirements of MIL-PRF-28800F, Class 3.)

Calibration

You can obtain the calibration certificate and information about calibration services for the PXIe-4309 at ni.com/calibration.

Self-calibration.....	On software command, the module computes gain, offset, and linearity corrections relative to the high-precision internal voltage reference.
Self-calibration interval	Depending on required absolute accuracy, self-calibration is recommended whenever the current device temperature differs by more than the specified temperature range from the device temperature at which the last self-calibration was performed.
Calibration interval.....	2 years
Warm-up time.....	15 minutes

Safety

This product meets the requirements of the following standards of safety for electrical equipment for measurement, control, and laboratory use:

- IEC 61010-1, EN 61010-1
- UL 61010-1, CSA 61010-1



Note For UL and other safety certifications, refer to the product label or the [Online Product Certification](#) section.

Electromagnetic Compatibility

This product meets the requirements of the following EMC standards for electrical equipment for measurement, control, and laboratory use:

- EN 61326-1 (IEC 61326-1): Class A emissions; Basic immunity
- EN 55011 (CISPR 11): Group 1, Class A emissions
- EN 55022 (CISPR 22): Class A emissions
- EN 55024 (CISPR 24): Immunity
- AS/NZS CISPR 11: Group 1, Class A emissions
- AS/NZS CISPR 22: Class A emissions
- FCC 47 CFR Part 15B: Class A emissions
- ICES-001: Class A emissions



Note In the United States (per FCC 47 CFR), Class A equipment is intended for use in commercial, light-industrial, and heavy-industrial locations. In Europe, Canada, Australia and New Zealand (per CISPR 11) Class A equipment is intended for use only in heavy-industrial locations.



Note Group 1 equipment (per CISPR 11) is any industrial, scientific, or medical equipment that does not intentionally generate radio frequency energy for the treatment of material or inspection/analysis purposes.



Note For EMC declarations and certifications, and additional information, refer to the [Online Product Certification](#) section.



Note Group 1 equipment (per CISPR 11) is any industrial, scientific, or medical equipment that does not intentionally generate radio frequency energy for the treatment of material or inspection/analysis purposes.



Note For EMC declarations and certifications, and additional information, refer to the [Online Product Certification](#) section.

CE Compliance

This product meets the essential requirements of applicable European Directives as follows:

- 2014/35/EU; Low-Voltage Directive (safety)
- 2014/30/EU; Electromagnetic Compatibility Directive (EMC)

Online Product Certification

Refer to the product Declaration of Conformity (DoC) for additional regulatory compliance information. To obtain product certifications and the DoC for this product, visit ni.com/certification, search by model number or product line, and click the appropriate link in the Certification column.

Environmental Management

NI is committed to designing and manufacturing products in an environmentally responsible manner. NI recognizes that eliminating certain hazardous substances from our products is beneficial to the environment and to NI customers.

For additional environmental information, refer to the *Minimize Our Environmental Impact* web page at ni.com/environment. This page contains the environmental regulations and directives with which NI complies, as well as other environmental information not included in this document.

Waste Electrical and Electronic Equipment (WEEE)



EU Customers At the end of the product life cycle, all products *must* be sent to a WEEE recycling center. For more information about WEEE recycling centers, National Instruments WEEE initiatives, and compliance with WEEE Directive 2002/96/EC on Waste and Electronic Equipment, visit ni.com/environment/weee.

电子信息产品污染控制管理办法（中国 RoHS）



中国客户 National Instruments 符合中国电子信息产品中限制使用某些有害物质指令 (RoHS)。关于 National Instruments 中国 RoHS 合规性信息，请登录 ni.com/environment/rohs_china。(For information about China RoHS compliance, go to ni.com/environment/rohs_china.)

Worldwide Support and Services

The NI website is your complete resource for technical support. At ni.com/support you have access to everything from troubleshooting and application development self-help resources to email and phone assistance from NI Application Engineers.

Visit ni.com/services for NI Factory Installation Services, repairs, extended warranty, and other services.

Visit ni.com/register to register your NI product. Product registration facilitates technical support and ensures that you receive important information updates from NI.

A Declaration of Conformity (DoC) is our claim of compliance with the Council of the European Communities using the manufacturer's declaration of conformity. This system affords the user protection for electromagnetic compatibility (EMC) and product safety. You can obtain the DoC for your product by visiting ni.com/certification. If your product supports calibration, you can obtain the calibration certificate for your product at ni.com/calibration.

NI corporate headquarters is located at 11500 North Mopac Expressway, Austin, Texas, 78759-3504. NI also has offices located around the world. For telephone support in the United States, create your service request at ni.com/support or dial 1 866 ASK MYNI (275 6964). For telephone support outside the United States, visit the Worldwide Offices section of ni.com/niglobal to access the branch office websites, which provide up-to-date contact information, support phone numbers, email addresses, and current events.

Refer to the *NI Trademarks and Logo Guidelines* at ni.com/trademarks for more information on NI trademarks. Other product and company names mentioned herein are trademarks or trade names of their respective companies. For patents covering NI products/technology, refer to the appropriate location: **Help»Patents** in your software, the `patents.txt` file on your media, or the *National Instruments Patents Notice* at ni.com/patents. You can find information about end-user license agreements (EULAs) and third-party legal notices in the `readme` file for your NI product. Refer to the *Export Compliance Information* at ni.com/legal/export-compliance for the NI global trade compliance policy and how to obtain relevant HTS codes, ECCNs, and other import/export data. NI MAKES NO EXPRESS OR IMPLIED WARRANTIES AS TO THE ACCURACY OF THE INFORMATION CONTAINED HEREIN AND SHALL NOT BE LIABLE FOR ANY ERRORS. U.S. Government Customers: The data contained in this manual was developed at private expense and is subject to the applicable limited rights and restricted data rights as set forth in FAR 52.227-14, DFAR 252.227-7014, and DFAR 252.227-7015.

© 2017 National Instruments. All rights reserved.