

M-TRS5-60B

Aliases (USEI60B0000000)

KEMET, TRS, Thermal Reed Switch, Axial, 2.5C Temperature Accuracy, High Reliability, High-Speed Response, Long Operational Life, Excellent Environmental Durability, High Temperature Accuracy, 60°C, Break

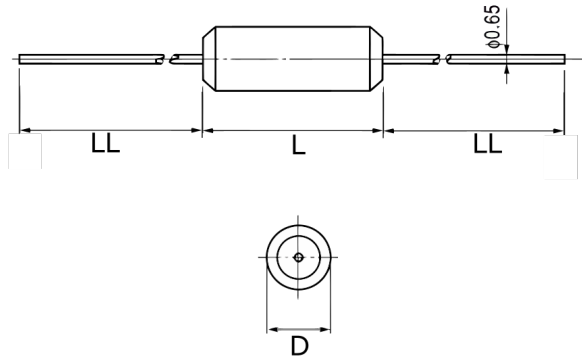

Click [here](#) for the 3D model.

Dimensions

D	8.8mm NOM
L	57.5mm MAX

Packaging Specifications

Packaging	Tray, Box
Packaging Quantity	1000
Component Weight	4.1g

General Information

Series	TRS
Type	Thermal Reed Switch
Style	Axial
Description	Thermal Reed Switch
Features	High Reliability, High-Speed Response, Long Operational Life, Excellent Environmental Durability, High Temperature Accuracy
Lead	Wire Leads
RoHS	Yes

Specifications

Switching Temperature	60C +/-2.5C
Temperature Range	-20/+150°C
Contact Type	Break
Voltage DC	200 VDC MAX (Opening/Closing), 1000 VAC/1 minute or 1200 VAC/1 second
Voltage AC	140 VAC MAX (Opening/Closing)
Current	0.55 Amps AC/DC MAX (Opening/Closing), 1 mAmps MIN (5VDC, Opening/Closing)
Resistance	150 mOhms MAX (Contact Resistance)
Max Opening/Closing Power	60.5 W (AC/DC); 10 W (DC)
Max Opening/Closing Voltage	140 V (AC); 200 V (DC)
Differential Temperature	10C Maximum