

General Safety Instructions:

READ SAFETY INSTRUCTIONS

Servicing:

These products are not customer serviceable. TDK-Lambda UK LTD. and their authorised agents only are permitted to carry out repairs.

Critical Components:

These products are not authorised for use as critical components in nuclear control systems, life support systems or equipment for use in hazardous environments without the express written approval of the Managing Director of TDK-Lambda EMEA.

Product Usage:

These products are designed for use within host equipment which restricts access to authorised competent personnel.

This product is a component power supply and is only to be installed by qualified persons within other equipment and must not be operated as a stand-alone product.

This product is for sale to business to business customers and can be obtained via distribution channels. It is not intended for sale to end users.

This product is a component power supply and does not fall within the scope of the EMC directive. Compliance with the EMC directive must be considered in the final installation. Please contact your local TDK-Lambda office

Environmental:

These products are IPX0 (IEC60335, IP00), and therefore chemicals/solvents, cleaning agents and other liquids must not be used.

Environment:

This power supply is a switch mode power supply for use in applications within a Pollution Degree 2, overvoltage category II environment. Material Group IIIb PCB's are used within it.

Output Loading:

The output power taken from the power supply must not exceed the rating stated on the power supply label, except as stated in the product limitations in this instruction manual.

Input Parameters:

This product must be operated within the input parameters stated in the product limitations in this instruction manual.

End of Life Disposal:

The unit contains components that require special disposal. Make sure that the unit is properly disposed of at the end of its service life and in accordance with local regulations.

**RISK OF ELECTRIC SHOCK****High Voltage Warning:**

Dangerous voltages are present within the power supply. The professional installer must protect service personnel from inadvertent contact with these dangerous voltages in the end equipment.

WARNING: When installed in a Class I end equipment, this product must be reliably earthed and professionally installed

When installed in a Class II end equipment, no earthing connection to the power supply is required.

CAUTION: DOUBLE POLE/NEUTRAL FUSING

The (+) or (-) output(s) can be earthed or left floating.

The mains input connector is not acceptable for use as field wiring terminals.

Internal fuses protect the unit and must not be replaced by the user. In case of internal defect, the unit must be returned to TDK-Lambda UK LTD or one of their authorised agents.

A suitable mechanical, electrical and fire enclosure must be provided by the end use equipment for mechanical, electric shock and fire hazard protection.

Allgemeine Sicherheitsvorschriften:

LESEN SIE DIE SICHERHEITSVORSCHRIFTEN

Wartung:

Diese Produkte können nicht durch den Kunden gewartet werden. Nur TDK-Lambda UK LTD. und deren zugelassene Vertriebshändler sind zur Durchführung von Reparaturen berechtigt.

Kritische Komponenten:

Diese Produkte sind nicht für die Verwendung als kritische Komponenten in nuklearen Kontrollsystemen, Lebenserhaltungssystemen oder Geräten in gefährlichen Umgebungen geeignet, sofern dies nicht ausdrücklich und in Schriftform durch den Geschäftsführer von TDK-Lambda EMEA genehmigt wurde.

Produktverwendung:

Diese Produkte sind zur Verwendung innerhalb von Host-Anlagen gedacht, die einen auf das Fachpersonal beschränkten Zugang haben.

Dieses Produkt ist eine Stromversorgungs-Komponente und sie darf nur von qualifiziertem Personal in andere Geräte eingebaut werden und sie darf NICHT als eigenständiges ("Stand-Alone") Gerät betrieben werden.

Dieses Produkt ist für den Verkauf an Geschäftskunden entwickelt worden und es kann über Distributionskanäle bezogen werden.

Es ist NICHT für den Verkauf an Endkunden gedacht und konzipiert.

Umwelt:

Diese Produkte sind IPX0 (IEC60335, IP00), aus diesem Grund dürfen keine Chemikalien/Lösungsmittel, Reinigungsmittel und andere Flüssigkeiten verwendet werden.

Umgebung:

Dieses Netzteil ist ein Schaltnetzteil zur Verwendung in einer Umgebung mit einem Verschmutzungsgrad 2, Überspannungskategorie II. Materialgruppe IIIb mit darin verwendeten PCBs.

Ausgangsstrom:

Der Ausgangsstrom des Netztesiles darf die Leistung, die auf dem Label des Netztesiles vermerkt ist, nur dann überschreiten, wenn dies in den Produktgrenzen dieses Handbuches ausgezeichnet ist.

Eingangsparameter:

Dieses Produkt muss innerhalb der Eingangsparameter, die in den Produktgrenzen dieses Handbuches angegeben sind, betrieben werden.

Entsorgung am Ende der Betriebszeit:

Das Gerät enthält Komponenten die unter Sondermüll fallen. Das Gerät muss am Ende der Betriebszeit ordnungsgemäß und in Übereinstimmung mit den regionalen Bestimmungen entsorgt werden.

**GEFAHR DURCH ELEKTRISCHEN SCHLAG****Hochspannungswarnung:**

Innerhalb des Netztesiles gibt es gefährliche Spannungen. Der Elektroinstallateur muss das Wartungspersonal vor versehentlichem Kontakt mit den gefährlichen Spannungen im Endgerät schützen.

WARNUNG! Falls Sie unser Netzgerät in eine Anwendung mit Schutzklasse 1 eingebaut haben, stellen Sie sicher, dass es fachgerecht installiert und zuverlässig geerdet ist.

Bei Einbau in eine Anwendung mit Schutzklasse 2 ist keine Erdung zum Netzgerät erforderlich.

ACHTUNG: ZWEIPOLIGE/NEUTRALE SICHERUNG

Die (+) oder (-) Ausgänge können geerdet werden oder unangeschlossen bleiben

Der Haupteingangsanschluss ist nicht für die Verwendung als Feldverdrahtungsanschluss geeignet.

Eine interne Sicherung schützt das Gerät und darf durch den Benutzer nicht ausgetauscht werden. Im Fall von internen Defekten muss das Gerät an TDK-Lambda UK LTD oder einen der autorisierten Vertriebshändler zurückgeschickt werden.

Ein geeignetes mechanisches, elektrisches und brandgeschütztes Gehäuse muss als Schutz vor der Gefahr von mechanischen Risiken, Stromschlägen und Brandschutz in dem Endgerät vorgesehen werden.

Consignes générales de sécurité:

LIRE LES CONSIGNES DE SECURITE

Entretien:

Ces produits ne peuvent pas être réparés par l'utilisateur. Seuls, TDK-Lambda UK LTD et ses agents agréés sont autorisés à effectuer des réparations.

Composants critiques:

Ces produits ne doivent pas être utilisés en tant que composants critiques dans des systèmes de commande nucléaire, dans des systèmes de sauvetage ou dans des équipements utilisés dans des environnements dangereux, sans l'autorisation écrite expresse du directeur général de TDK-Lambda EMEA.

Utilisation du produit:

Ces produits sont conçus pour être utilisés dans un équipement hôte dont l'accès n'est autorisé qu'aux personnes compétentes.

Ce produit est une alimentation considérée comme un composant devant être installé par des personnes qualifiées, dans un autre équipement. Il ne doit pas être utilisé en tant que produit fini.

Ce produit est destiné à la vente entre entreprises et peut être obtenu via des canaux de distribution.

Il n'est pas prévu à la vente pour les particuliers.

Ce produit est une alimentation considérée comme un composant, il ne relève pas du champ d'application de la directive CEM. Le respect de la directive CEM doit être pris en compte dans l'installation finale. Veuillez contacter votre bureau TDK-Lambda le plus proche.

Environnement:

Ces produits sont IPX0 (IEC60335, IP00), et donc on ne doit pas utiliser des produits chimiques/solvants, des produits de nettoyage et d'autres liquides.

Environnement fonctionnel:

Cette alimentation fonctionne en mode commutation pour utilisation dans des applications fonctionnant dans un environnement avec Degré de Pollution 2 et catégorie de surtension II. Elle utilise des cartes des circuits imprimés (PCB) de Groupe IIIb.

Intensité soutirée:

L'intensité soutirée de l'alimentation ne doit pas dépasser l'intensité nominale marquée sur la plaque signalétique, sauf indications contraires dans les limitations du produit décrit dans ce manuel.

Paramètres d'entrée:

Ce produit doit être utilisé à l'intérieur des paramètres d'entrée indiqués dans les limitations du produit dans ce manuel.

Élimination en fin de vie:

L'alimentation contient des composants nécessitant des dispositions spéciales pour leur élimination. Vérifiez que cette alimentation est mise au rebut correctement en fin de vie utile et conformément aux réglementations locales en vigueur.



RISQUE DE CHOC ELECTRIQUE

Attention-Danger haute tension:

Des tensions dangereuses sont présentes dans l'alimentation. L'installateur doit protéger le personnel d'entretien contre un contact involontaire avec ces tensions dangereuses dans l'équipement final.

AVERTISSEMENT: Si ce produit est installé dans un équipement final de classe I, il doit être mis à la terre de

manière fiable et installé par un professionnel averti.

S'il est installé dans un équipement final de classe II, il n'est pas nécessaire de raccorder l'alimentation à la terre.

ATTENTION: FUSIBLE BIPOLAIRE/NEUTRE

Les sorties (+) ou (-) peuvent être raccordées à la terre ou laissées flottantes.

Le connecteur d'entrée d'alimentation principale ne doit pas être utilisé comme borne de raccordement.

Un fusible interne protège le module et ne doit pas être remplacé par l'utilisateur. En cas de défaut interne, le module doit être renvoyé à TDK-Lambda UK LTD ou l'un de ses agents agréés.

Une enceinte appropriée doit être prévue par l'utilisateur final pour assurer la protection contre les chocs mécaniques, les chocs électriques et l'incendie.

Norme generali di sicurezza:

SI PREGA DI LEGGERE LE NORME DI SICUREZZA

Manutenzione:

Il cliente non può eseguire alcuna manutenzione su questi prodotti. L'esecuzione delle eventuali riparazioni è consentita solo a TDK-Lambda UK LTD e ai suoi agenti autorizzati.

Componenti critici:

Non si autorizza l'uso di questi prodotti come componenti critici all'interno di sistemi di controllo nucleari, sistemi necessari alla sopravvivenza o apparecchiature destinate all'impiego in ambienti pericolosi, senza l'esplicita approvazione scritta dell'Amministratore Delegato di TDK-Lambda EMEA.

Uso dei prodotti:

Questi prodotti sono progettati per l'uso all'interno di un'apparecchiatura ospite che limiti l'accesso al solo personale competente e autorizzato.

Questo prodotto è da considerarsi come un alimentatore professionale componente e come tale deve essere installato da personale qualificato all'interno di altre apparecchiature e non può essere utilizzato come prodotto indipendente.

Questo prodotto non è inteso per la vendita al dettaglio o agli utilizzatori finali.

Questo alimentatore è da considerarsi come un componente e come tale non è assoggettato dagli scopi della direttiva EMC. Conformità alla direttiva EMC deve essere considerata nell'installazione finale di utilizzo. Gli uffici di TDK-Lambda Sas Succursale Italiana sono a vostra disposizione per ulteriori ragguagli.

Condizioni ambientali:

Questi prodotti sono classificati come IPX0 (IEC60335, IP00), dunque non devono essere utilizzati sostanze chimiche/solventi, prodotti per la pulizia o liquidi di altra natura.

Ambiente:

Questo prodotto è un alimentatore a commutazione, destinato all'uso in applicazioni rientranti in ambienti con le seguenti caratteristiche: Livello inquinamento 2, Categoria sovratensione II. Questo prodotto contiene schede di circuiti stampati in materiali di Gruppo IIIb.

Carico in uscita:

La potenza in uscita ottenuta dall'alimentatore non deve superare la potenza nominale indicata sulla targhetta dell'alimentatore, fatto salvo dove indicato nei limiti per il prodotto specificati in questo manuale.

Parametri di alimentazione:

Questo prodotto deve essere utilizzato entro i parametri di alimentazione indicati nei limiti per il prodotto, specificati in questo manuale.

Smaltimento:

L'unità contiene componenti che richiedono procedure speciali di smaltimento. Accertarsi che l'unità venga smaltita in modo corretto al termine della vita utile e nel rispetto delle normative locali.



RISCHIO DI SCOSSA ELETTRICA

Avvertimento di alta tensione:

All'interno dell'alimentatore sono presenti tensioni pericolose. Gli installatori professionali devono proteggere il personale di manutenzione dal rischio di contatto accidentale con queste tensioni pericolose all'interno dell'apparecchiatura finale.

ATTENZIONE: Se installato in un'attrezzatura di classe I, questo prodotto deve essere collegato a terra in modo affidabile ed installato in modo professionale.

Se installato in un'attrezzatura di classe II, non è necessario alcun collegamento a terra.

ATTENZIONE: PROTEZIONE CON FUSIBILE BIPOLARE/NEUTRO

Le uscite (+) o (-) possono essere messa a terra o lasciate isolate.

Il connettore dell'alimentazione principale non può essere utilizzato come terminale di collegamento di campo.

Un fusibile interno protegge l'unità e non deve essere sostituito dall'utente. Nell'eventualità di un difetto interno, restituire l'unità a TDK-Lambda UK LTD o a uno dei suoi agenti autorizzati.

L'apparecchiatura finale deve includere una recinzione meccanica, elettrica e antincendio per proteggere dai pericoli di natura meccanica, dalle scosse elettriche e dai pericoli di incendio.

Instrucciones generales de seguridad:

LEA LAS INSTRUCCIONES DE SEGURIDAD

Servicio:

Estos productos no pueden ser reparados por los clientes. TDK-Lambda UK LTD. y sus agentes autorizados son los únicos que pueden llevar a cabo las reparaciones.

Componentes fundamentales:

Estos productos no pueden ser utilizados como componentes fundamentales en sistemas de control nuclear, sistemas de soporte vital o equipos a utilizar en entornos peligrosos sin el consentimiento expreso por escrito del Director General de TDK-Lambda EMEA.

Uso de los productos:

Estos productos han sido diseñados para ser utilizados en un equipo central que restrinja el acceso al personal cualificado autorizado.

Este producto es una fuente de alimentación y sólo puede ser instalado por personal cualificado dentro de otros equipos y no debe ser tratado como un producto independiente. Este producto debe ser vendido entre empresas profesionales y solo puede obtenerse a través de los canales de distribución. No está destinado para la venta a usuarios finales.

Este producto es una fuente de alimentación y no se ve afectada por la directiva EMC. El cumplimiento de la directiva EMC se debe considerar en la instalación final. Por favor, póngase en contacto con su oficina local de TDK - Lambda

Medioambiental:

Estos productos son IPX0 (IEC60335, IP00) y, por tanto, no pueden utilizarse sustancias químicas/disolventes, agentes de limpieza ni otros líquidos.

Medio ambiente:

Esta fuente de alimentación es una fuente de alimentación de modo conmutado a utilizar en aplicaciones dentro de un entorno con un Grado de contaminación 2 y una Categoría de sobretensión II. En él se utilizan policloruros de bifenilo del Grupo de materiales IIIb.

Carga de salida:

La potencia de salida tomada de la fuente de alimentación no puede sobrepasar el valor nominal indicado en la etiqueta de la fuente de alimentación, excepto en los casos indicados en las limitaciones del producto en este manual.

Parámetros de entrada:

Este producto debe ser utilizado dentro de los parámetros de entrada indicados en las limitaciones del producto en este manual.

Desecho de la unidad:

La unidad contiene componentes que deben ser desechados de una manera especial. Asegúrese de desechar correctamente la unidad al final de su vida útil y conforme a las normas locales vigentes.



PELIGRO DE DESCARGAS ELÉCTRICAS

Advertencia de alta tensión:

En esta fuente de alimentación hay tensiones peligrosas. El instalador profesional debe proteger al personal de servicio contra cualquier contacto accidental con estas tensiones peligrosas en el equipo final.

ADVERTENCIA: La instalación de este producto en un equipo de clase I la deben llevar a cabo profesionales y el producto debe estar conectado a tierra.

Para instalar este producto en un equipo de clase II no es necesario que la alimentación esté conectada a tierra.

PRECAUCIÓN: PROTECCIÓN POR FUSIBLES BIPOLAR/NEUTRA

La salida o salidas (+) o (-) pueden conectarse a tierra o se las puede dejar flotando.

El conector de entrada de la red no es apto para ser utilizado a modo de bornes de cableado de campo.

Un fusible interno protege la unidad y este no debe ser nunca reemplazado por el usuario. En caso de existir algún defecto interno, la unidad debe ser enviada a TDK-Lambda UK LTD o a uno de sus agentes autorizados.

El equipo de uso final debe constituir un recinto de protección mecánica, eléctrica y contra incendios de protección mecánica, contra descargas eléctricas y contra el peligro de incendios.

Instruções gerais de segurança:

LEIA AS INSTRUÇÕES DE SEGURANÇA

Manutenção:

Estes produtos não são podem ser submetidos a manutenção por parte do cliente. Apenas a TDK-Lambda UK LTD e os seus agentes autorizados têm permissão para realizar reparações.

Componentes essenciais:

Não é autorizada a utilização destes produtos como componentes essenciais de sistemas de controlo nuclear, sistemas de suporte de vida ou equipamento para utilização em ambientes perigosos sem a expressa autorização por escrito do Director-Geral da TDK-Lambda EMEA.

Utilização do produto:

Estes produtos foram concebidos para utilização dentro de um equipamento de alojamento que apenas permita o acesso a pessoal qualificado autorizado.

Este produto é uma alimentação considerado com um componente para ser instalado por pessoas qualificadas, em outros equipamentos. Não deve ser usado como um produto acabado.

Este produto é destinado para venda entre as empresas e pode ser obtido através de canais de distribuição.

Não se destina à venda aos particulares

Este produto é uma alimentação considerado com um componente, não é dentro do application âmbito da directiva CEM.

Conformidade com a directiva CEM devem ser considerados na instalação final.

Entre em contacto com seu escritório TDK-Lambda mais próximo.

Ambiental:

Estes produtos são IPX0 (IEC60335, IP00) e, como tal, não se devem utilizar químicos/solventes, agentes de limpeza e outros líquidos.

Ambiente:

Esta fonte de alimentação é uma fonte de alimentação do modo de comutação para utilização em aplicações com um Nível de Poluição 2 e ambientes da categoria de sobretensão II. São utilizadas placas de circuitos impressos do grupo de materiais IIIb.

Carga de saída:

A potência de saída extraída da fonte de alimentação não deve exceder a classificação assinalada na etiqueta da fonte de alimentação, excepto quando indicado nas limitações do produto neste guia.

Parâmetros de entrada:

Este produto deve ser utilizado dentro dos parâmetros de entrada indicados nas limitações do produto neste guia.

Eliminação no fim de vida:

A unidade contém componentes que necessitam de procedimentos especiais de eliminação. Certifique-se de que a unidade é devidamente eliminada no fim da sua vida útil e que tal é feito em conformidade com os regulamentos locais.



RISCO DE CHOQUE ELÉCTRICO

Aviso de alta tensão:

Estão presentes tensões perigosas dentro da fonte de alimentação. O profissional que realizar a instalação deve proteger o pessoal de assistência contra contactos inadvertidos com estas tensões perigosas do equipamento final.

AVISO: Quando instalado num equipamento de Classe I, este produto deve ser ligado à terra de forma fiável e instalado por um profissional.

Quando instalado num equipamento de Classe II, não é necessário que a fonte de alimentação tenha ligação à terra.

CUIDADO: LIGAÇÃO DE FUSÍVEIS DE DOIS PÓLOS/NEUTRA

As saídas (+) e (-) podem ser ligadas à terra ou deixadas soltas.

O conector de entrada de alimentação não deve ser utilizado como terminal de cablagens no local.

Existe um fusível interno que protege a unidade e que não deve ser substituído pelo utilizador. Em caso de defeito interno, a unidade deve ser devolvida à TDK-Lambda UK LTD ou a um dos seus agentes autorizados.

O equipamento de utilização final deve fornecer um bastidor com protecção mecânica, eléctrica e contra incêndios adequada.

Special Instructions for medical applications of the following standards:IEC/EN 60601-1 3rd Edition

ANSI/AAMI ES 60601-1

CSA 22.2 No 60601-1

These products are designed for continuous operation within an overall enclosure, and must be mounted such that access to the mains terminals is restricted. See the appropriate standard listed above.

For Class II installation, these products need to be fixed such that they are isolated from unearthed accessible conductive parts by at least 2 MOPP's.

The chassis/cover when fitted to the CUS250M in a Class II configuration has 1 MOPP (Basic/Supplementary) insulation to Primary and 1 MOPP (Basic/Supplementary) insulation to Secondary.

These products are NOT suitable for use in the presence of flammable anesthetic mixtures with air or with oxygen, or with nitrous oxide.

For IEC/EN 60601-1 3rd Edition, ANSI/AAMI ES 60601-1, CSA 22.2 No 60601-1, these products provide reinforced insulation between input and outputs of 2 MOPPs. 1 MOPP from input to Earth/chassis/customer fixing point and 1 MOPP from output to Earth/chassis/customer fixing point.

These products are suitable for B and BF type medical equipment.

These products are NOT protected against the ingress of water.

All outputs have basic spacing to earth rated for mains at 250Vac, and due consideration must be given to this in the end product design.

These products have SELV outputs.

Reference should be made to local regulations concerning the disposal of these products at the end of their useful life.

Where any part of this product is made accessible to the operator in the end use equipment, the operator must not touch this part and the patient at the same time.

Special Instructions for IEC/EN/UL/CSA 60950-1

The chassis/cover/customer fixing points when fitted to the CUS250M in a Class II configuration has (Basic/Supplementary) insulation to Primary and (Basic/Supplementary) insulation to Secondary.

Special Instructions for IEC/EN/UL/CSA 62368-1

For Single fuse (/E option) the end equipment manufacturer must use a polarised input connector.

Environmental Specifications:

Description	Operation	Storage
Use	Indoor	-
Temperature	-20°C to 85°C (Model dependent. See Variations and Limitations or Power Curves for de-ratings)	-40°C to 85°C (70°C for /F option)
Humidity	5 to 95% (15 to 90% for fan versions) RH, non-condensing	5 - 95% (15 - 90% for fan versions) RH, non-condensing
Altitude	-200m to 5000m	-200m to 5000m
Pressure	70kPa to 106kPa	54kPa to 106kPa
Orientation	All except upside down	All
Material Group		IIIb
Pollution Degree		2
Overtoltage Category		II
Description		
Class	I and II	
Weight	340g Maximum	
IP Rating	IPX0 (IEC60335, IP00)	

WARNING: No modification of this product is allowed.

Level of Insulation:

Dielectric Strength type testing is carried out as follows:

Primary mains circuit to earth: 2635Vdc

Primary mains circuits to secondary: 6594Vdc

Secondary circuits to earth: 2121Vdc.

Safety Approvals:

UL60950-1 and CSA22.2 No.60950-1 - UL Recognised. C-UL for Canada.

IEC/EN60950-1

UL/CSA 60601-1/ANSI/AAMI ES 60601-1 - UL + C -UL approval

IEC/EN/UL 62368-1 – CE & UKCA marks

CE marking when applied to any CUS250M product, indicates compliance with the Low Voltage Directive in that it complies with EN62368-1 and with the RoHS Directive.

UKCA marking when applied to any CUS250M product indicates compliance with the Electrical Equipment (Safety) Regulations 2016 in that it complies with EN62368-1 and with the Restriction of the Use of Certain Hazardous Substances in Electrical and Electronic Equipment Regulations 2012

Fusing:

Internal Dual fuses (F1 and F2) in the live and Neutral line, T5AH, 250V. (Standard CUS250M)

Internal Single fuse (F1) in the live line, T5AH, 250V. (Option /E)

Symbols:

N **L**

Neutral **Live**

Unit Nomenclature

Note: All output voltages/variants may not be available as standard units. Refer to datasheet for standard product range. These (and other variants) may be available as non-standard or custom units, please contact our sales team for details.

CUS250M models as described below:

Unit Product Code: CUS250M-xxVx/yyyyy

Where:

xxVx = Channel 1 output voltage within the output voltage adjustment range from the output Parameters table below.

List of Standard Options (yyyyy):

Case Options (all case options and metal base include gap pads)

Blank = Standard model with integral metal baseplate

U = U channel

A = U channel with cover

F = U channel with cover and top mounted fan

C = M3 inserts for underside mounting

Connector Option:

Blank = JST Connector

M = Molex type connector

Fuse Options:

Blank = Dual fuse (standard)

E = Single fuse in live line

Signal, Standby Options:

Blank = No options (fan supply is standard)

G = 5V, 0.1A Standby Supply, Remote on/off (enable), DC_OK, AC_Fail

J = 5V, 0.1A Standby Supply, Remote on/off (inhibit), DC_OK, AC_Fail

K = No Options, no Fan Supply

Leakage Current Options:

Blank = Standard leakage (<150µA)

Output Connector Options:

Blank = Screw Terminal

L* = Custom Option *can be any number denoting different connector type

Example:

CUS250M-24V5/UE = 24.5V with U-Channel, single fuse in the live line

Unit product code may be prefixed with 'K' followed by any standard product code followed by /NNNNL where N is a string of numbers which identifies the non-standard requirement and L is an optional letter, starting with 'A' which is incremented for any customer revision.

Example: KCUS250M-24/0001A

Unit product code may be suffixed by /NNNNL where N is a string of numbers which identifies the non-standard requirement. L is an optional letter, starting with 'A' which is incremented for any customer revision.

Example: CUS250M-24/0001A

Unit product code may be suffixed by SPNN (where NN may be any number of characters indicating non-safety related model differences) (SP represents a sales code).

Example: CUS250M-24/FE/SP01

Input Parameters

Parameter	60601-1	60950-1 & 62368-1
Nominal input voltage	100 - 240Vac	100 - 240Vac
Input voltage range	85 - 264Vac	85 - 264Vac
Input frequency range	47 - 63Hz	47 - 63Hz*
Maximum input current	3.1A rms	3.1A rms

*For operation at 440Hz, please contact Technical Sales.

Output Parameters

The CUS250M standard models are shown in the table below. These models may be either fan, forced air, conduction or convection cooled. The output parameters are shown in the tables below.

Output	Nomenclature Designation	V _{out} Nominal (V)	V _{out} Range (V)	Max I _{out} (A)	Max P _{out} (W)
CH1	12	12	12 – 13.2	20.83	250
	24	24	24 – 26.4	10.41	250
Standby Option	G, J	5	Fixed	0.1	10
Fan Supply*	All except Option K	11.4	Fixed	0.5	5.7

*Fan output tracks V_{out} range

Variations and Limitations:

All outputs are SELV in accordance with 60950-1.

All outputs are ES1 in accordance with 62368-1.

Output power is reduced linearly by 10% for input voltages from 89.9Vac to 85Vac.

Customer Forced Air Cooling max ambient 85°C (note 1)

Convection and conduction/cold plate Cooling (U channel with cover-Option A) max ambient 75°C (note 1)

Convection and conduction/cold plate Cooling (U channel and open frame) max ambient 80°C (note 1)

Fan supplied ratings/Option F max ambient 70°C, from 50°C to 70°C the output power is de-rated by 0.5°C per watt

Note 1: Maximum output power and current ratings are dependent on the ambient used in the end equipment. Please see power curves for guidance.

Earthing

The CUS250M may be earthed from any suitable point (H1, H2, H3, H4 or via the M3 inserts provided in the underside of the U-Chassis for the C option). Protective bonding must be verified by the end equipment manufacturer in the end application. H1 may only be used as an earth point on the standard model (open frame) provided that this hole is used to connect to an earthed metal substrate that also connects all other mounting holes.

Power curves

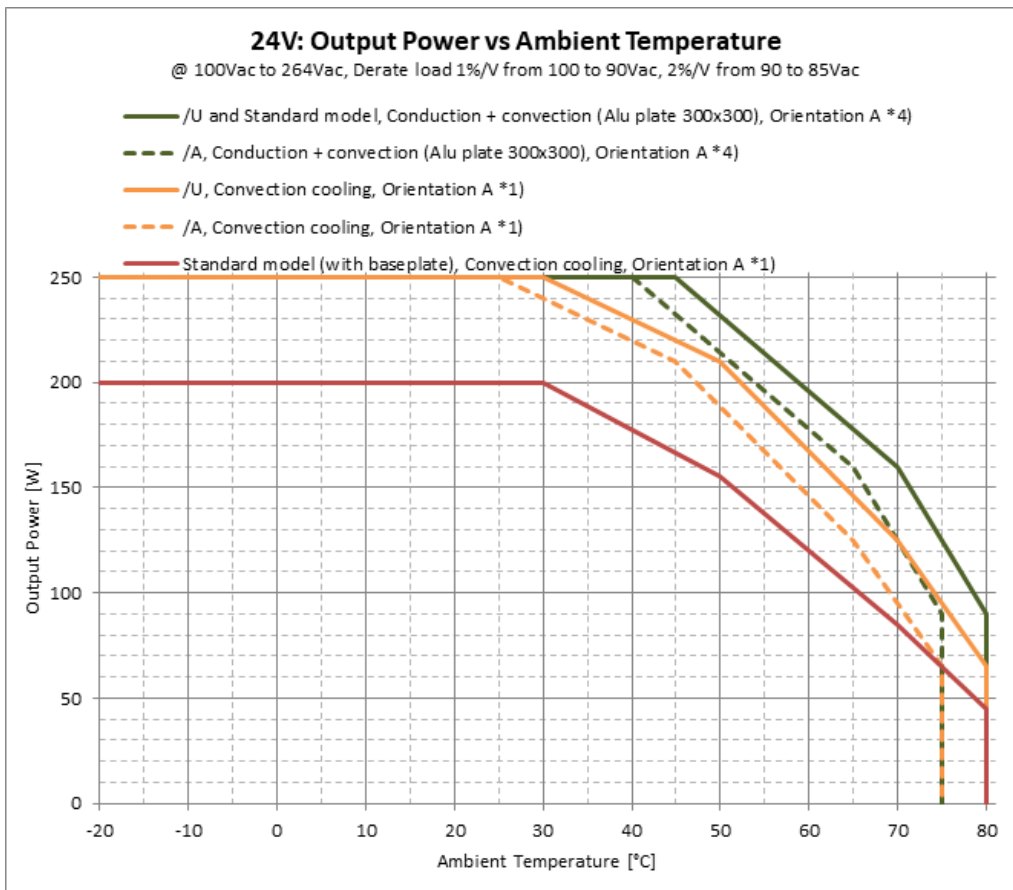
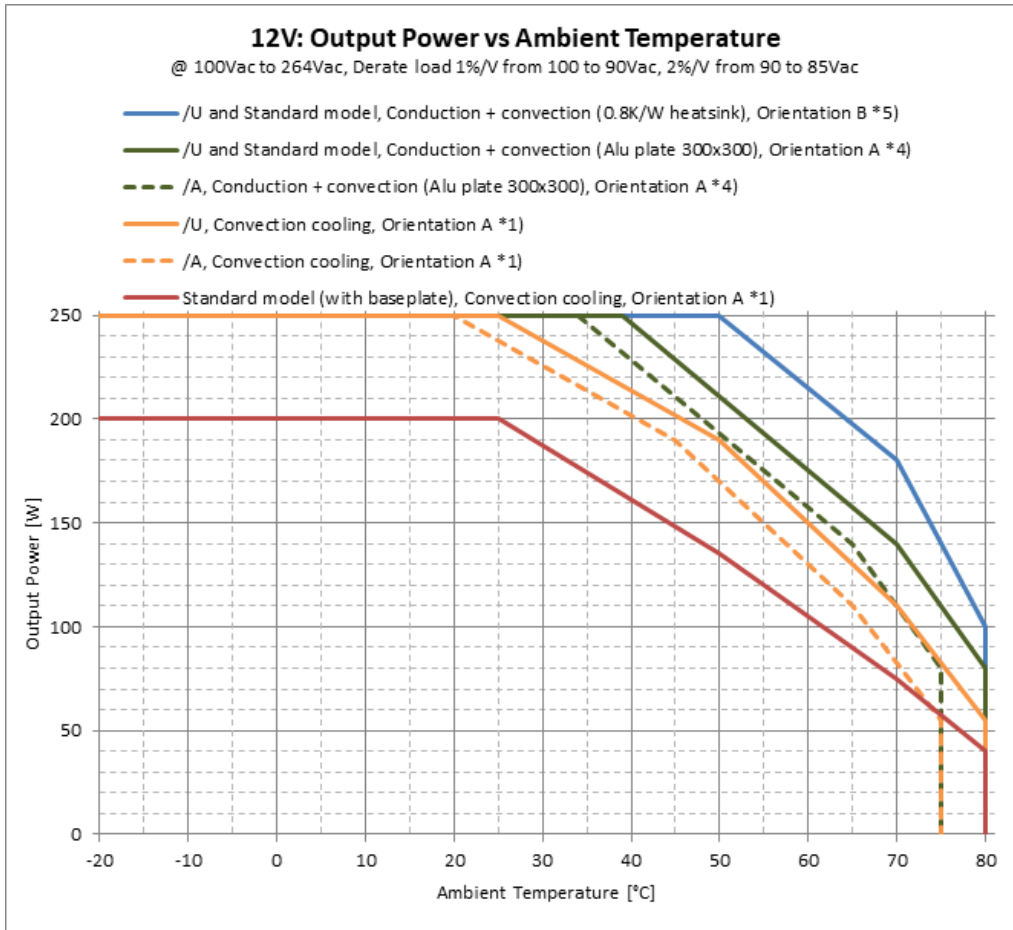

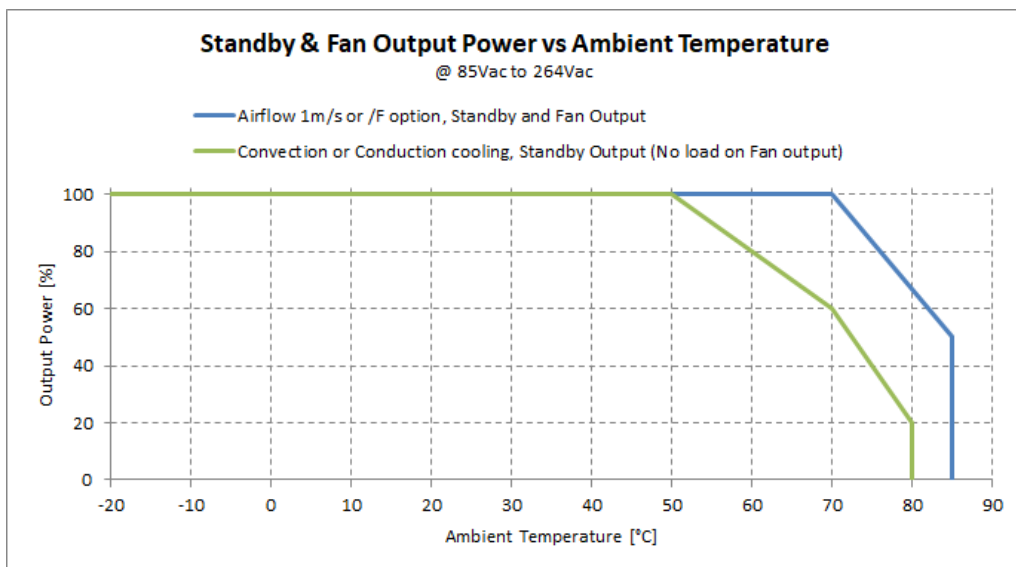
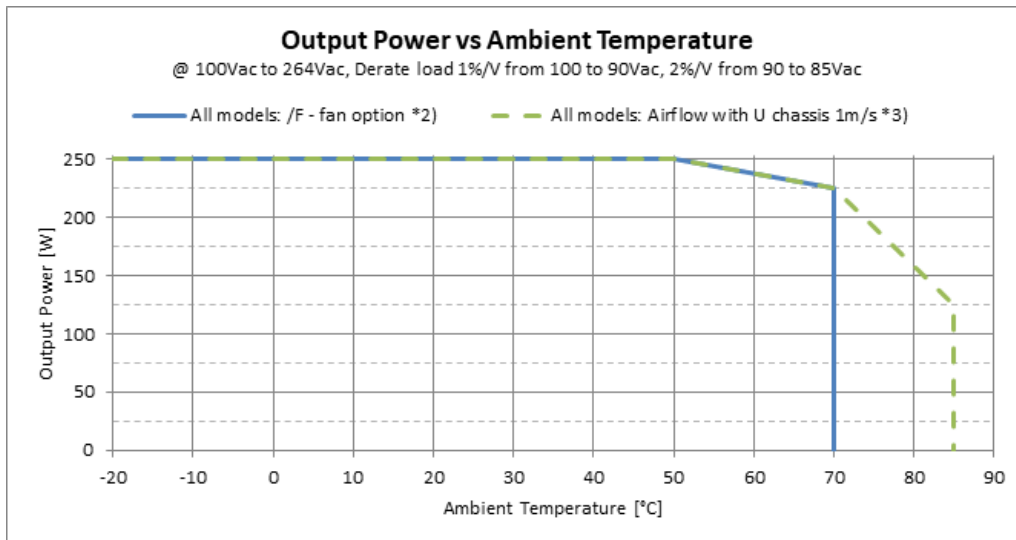

Cooling for unit

Component temperatures for customer air or convection cooled models must be monitored in the end use application as described in the “Cooling for Unit Temperature Table” below.

The following method must be used for determining the safe operation of PSUs.

The components listed in the following table must not exceed the temperatures given. To determine the component temperatures the heating tests must be conducted in accordance with the requirements of the standard in question. Consideration should also be given to the requirements of other safety standards.

Test requirements include: PSU to be fitted in its end-use equipment and operated under the most adverse conditions permitted in the end-use equipment instruction manual/specification and which will result in the highest temperatures in the PSU.

To determine the most adverse conditions consideration should be given to the end use equipment maximum operating ambient, the PSU loading and input voltage, ventilation, end use equipment orientation, the position of doors & covers, etc.

Temperatures should be monitored using type K fine wire thermocouples (secured with cyanoacrylate adhesive or similar) placed on the hottest part of the component (out of any direct airflow) and the equipment should be run until all temperatures have stabilised.

Cooling for Unit Temperature Table:

Circuit Ref.	Description	Max Temperature (°C)
L1	Common Mode Choke	110
L3	PFC Choke	125
L4	Differential Mode Choke	140
C5	Film Capacitors	105
C6, C104, XC104, XC105, XC400, XC502	Electrolytic Capacitors	85 (105)
C1	X Capacitors	110
C2, C3, C100, C102, C103	Y Capacitors	119 (125)
TX1	Transformer Winding	125
TX300	Transformer Winding	110
XU100, XU301, XU402	Opto-couplers	106 (125)
XD2	Bridge Diode	130
XQ2	FET	130
J1	Input Connector	105
J9 (Connector Board Only)	Output Connector	105

Higher temperature limits (in brackets) may be used but product life may be reduced.

LAYOUT FOR CUS250M UNITS

Base Board Top Side:

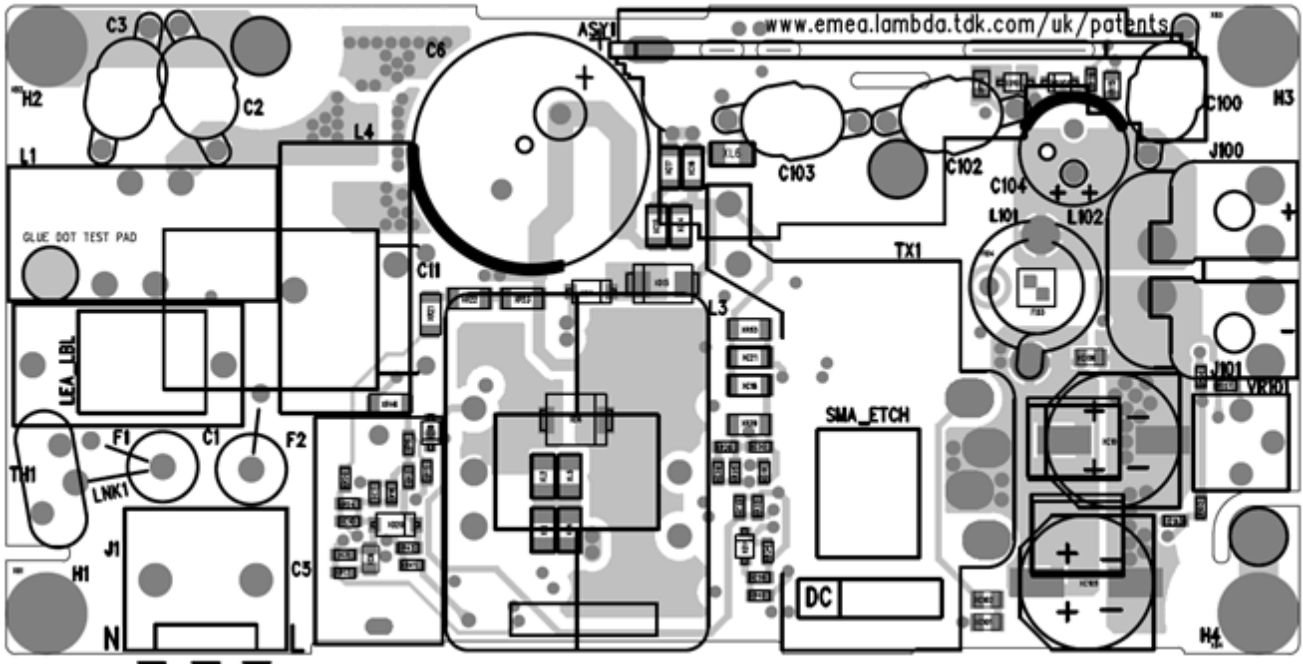

Base Board Bottom Side:

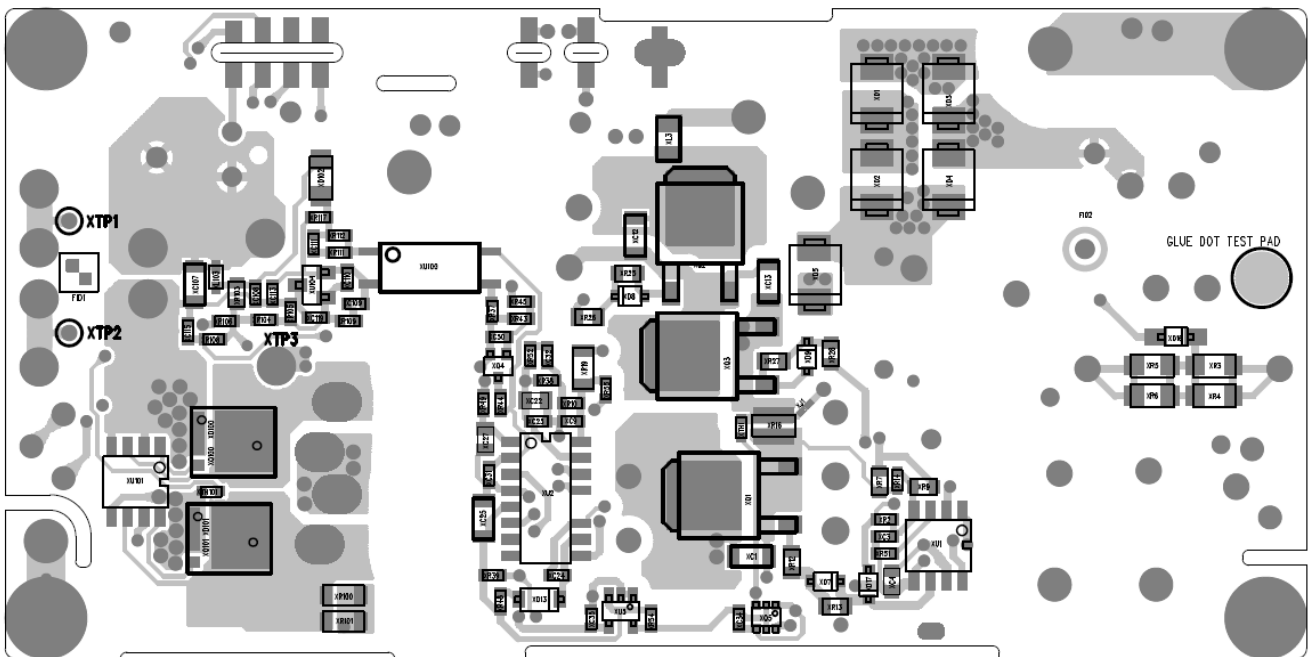

Daughter Board Top Side:

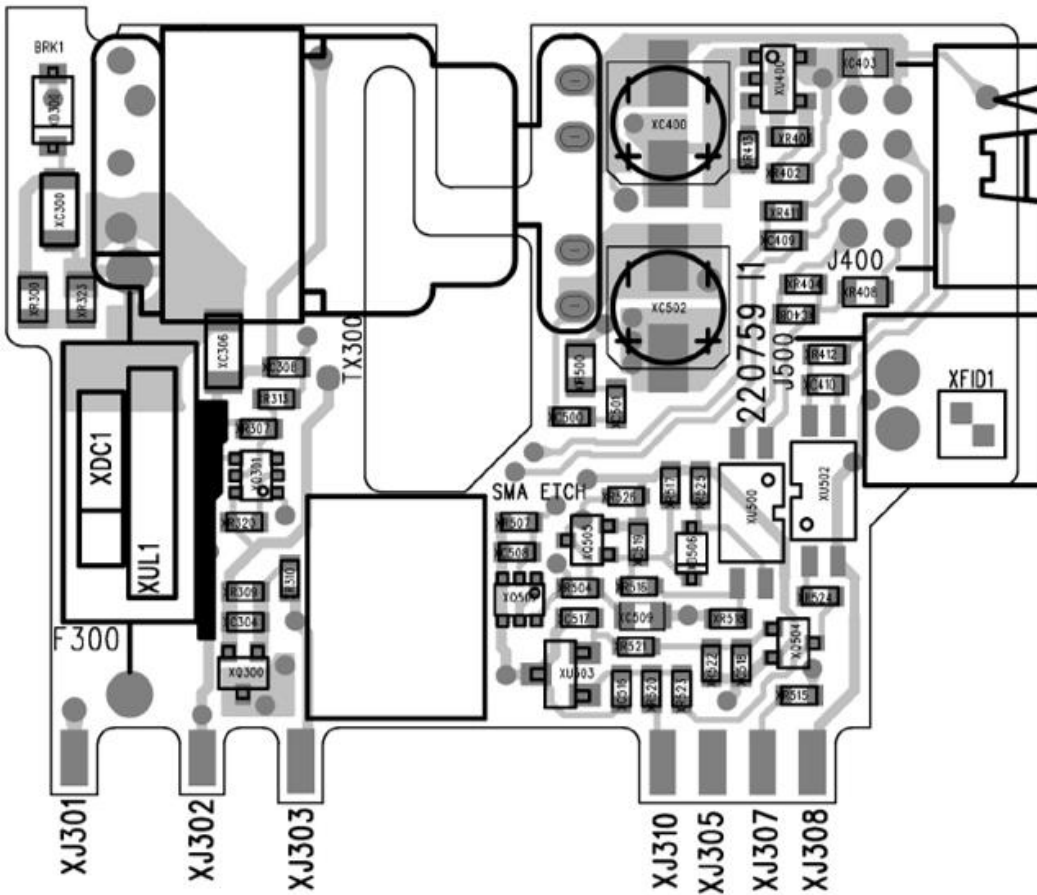

Daughter Board Bottom Side:

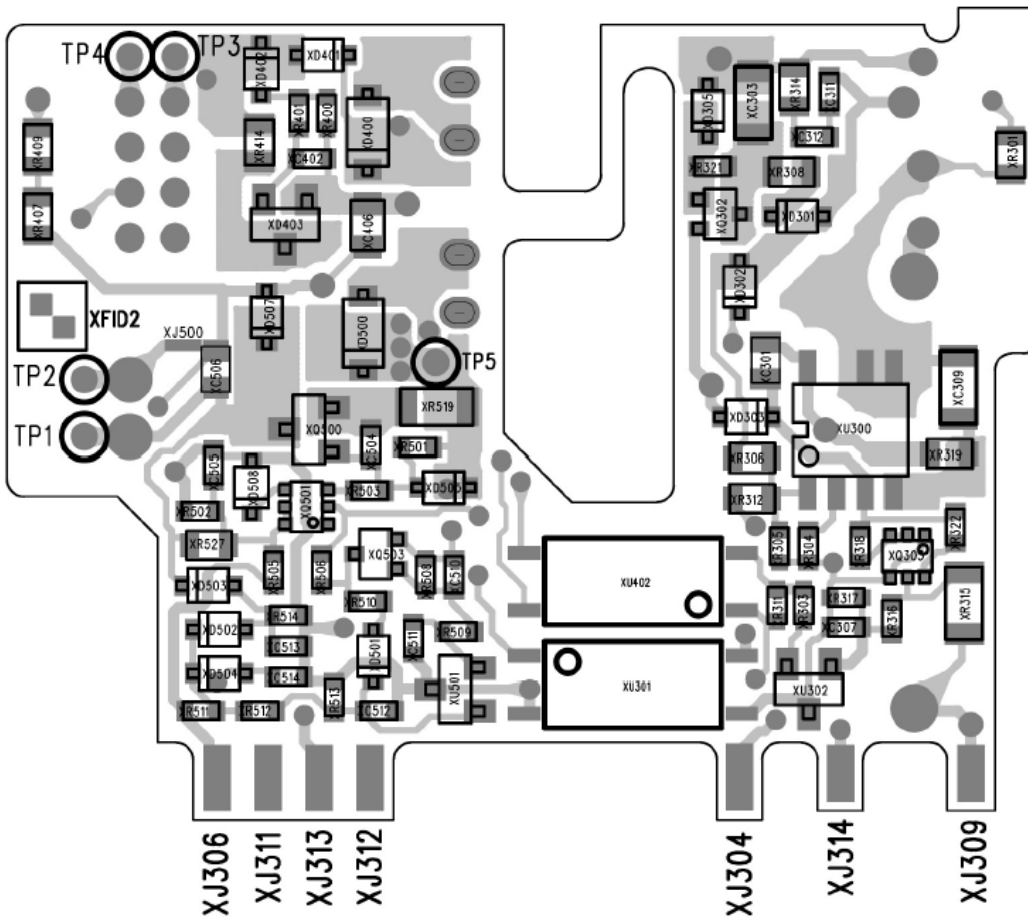

Connections

CONNECTOR	MANUFACTURER	HOUSING	CRIMP
J1	JST	VAR-2	SVA-11T-P1.1
J100 & J101	-	-	M3 TAG
J400	MOLEX	51110-0851	50394
J500	MOLEX	50-37-5023	08-70-1039

J1

PIN	CONNECTION
1	NEUTRAL
2	NOT CONNECTED
3	LIVE

J400

PIN	CONNECTION
1	+V STANDBY (+5V)
2	0V STANDBY
3	AC FAIL COLLECTOR
4	DC OK COLLECTOR
5	AC FAIL EMITTER
6	DC OK EMITTER
7	REMOTE ON/OFF -
8	REMOTE ON/OFF +

J500

PIN	CONNECTION
1	+V FAN
2	0V FAN

Outline drawings for CUS250M

Standard Model:

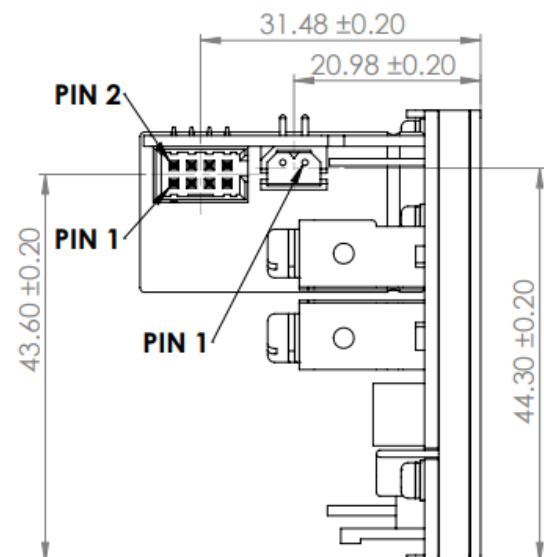
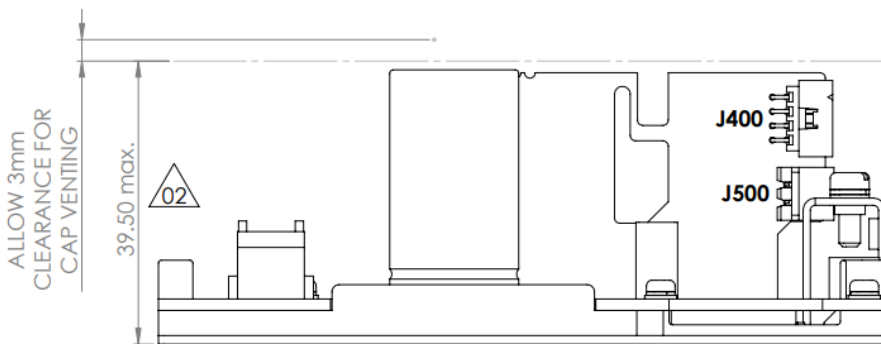
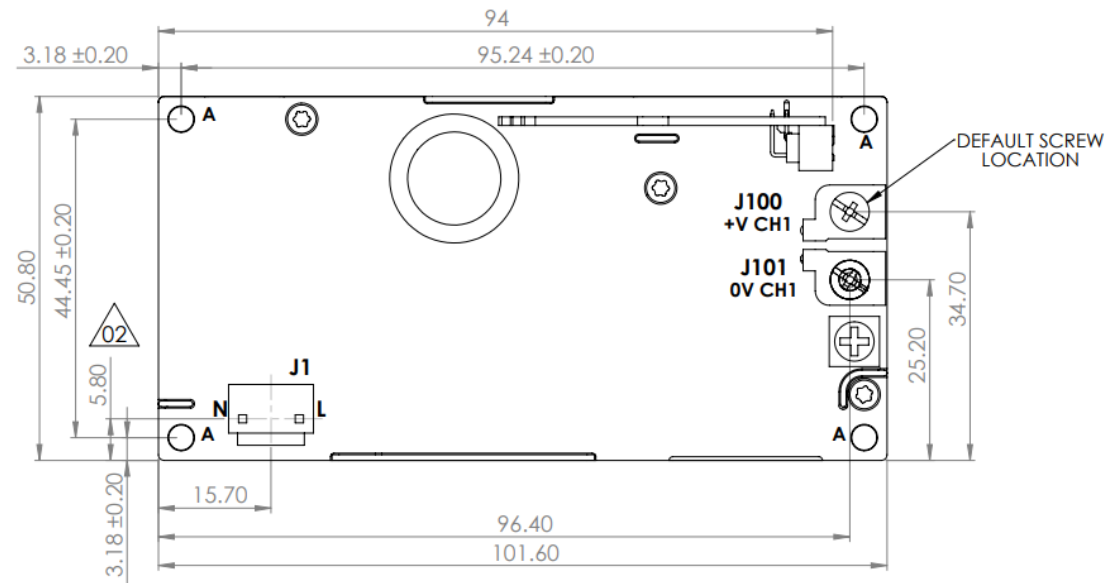

- NOTE:
1. "A" FIXING HOLES $\varnothing 3.5$ TO ACCOMMODATE M3 SCREW. MAXIMUM TOP SIDE WASHER DIAMETER - 6mm
 2. ALL UNSTATED TOLERANCES ± 0.4 mm

U Option (U Channel):

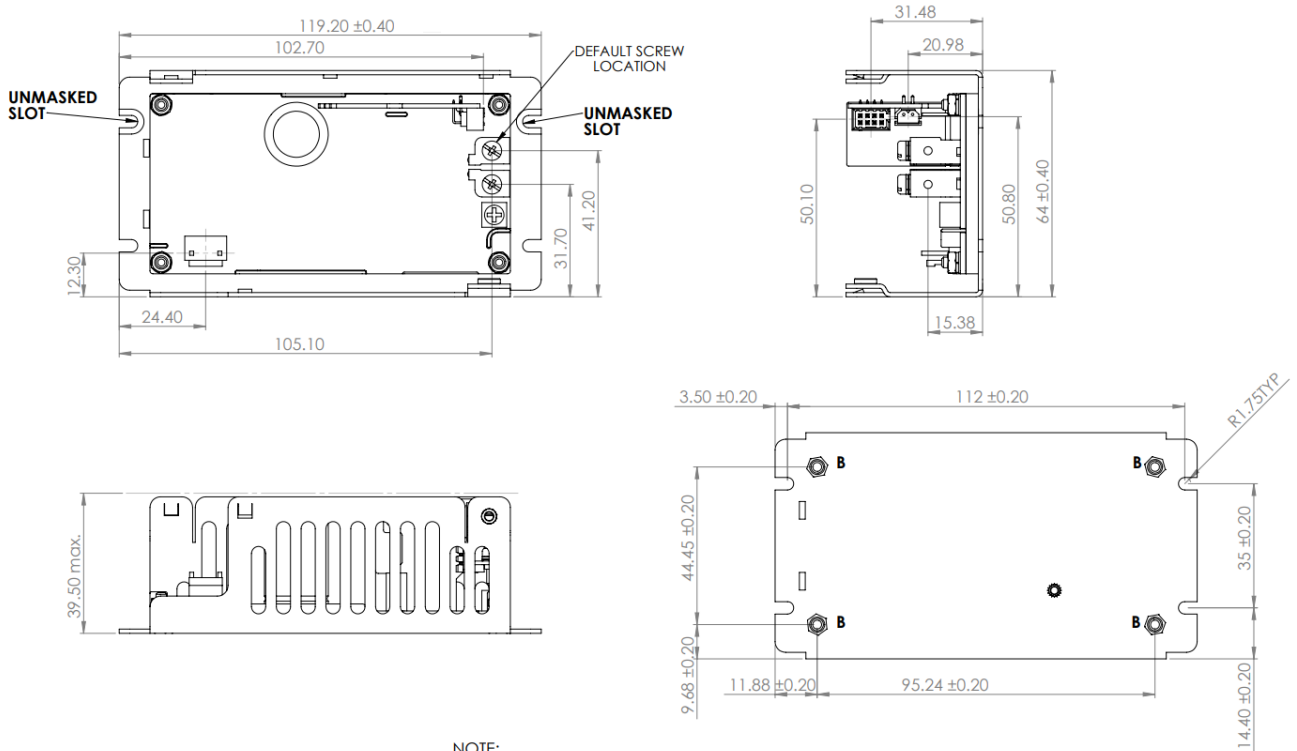

NOTE:
 1. "B" HOLES 4 X M3 FIXING . MAX PENETRATION 3.75mm. RECOMMENDED TORQUE 0.5-0.6Nm
 2. ALL UNSTATED TOLERANCES ± 0.4mm

A Option (U Channel and Cover):

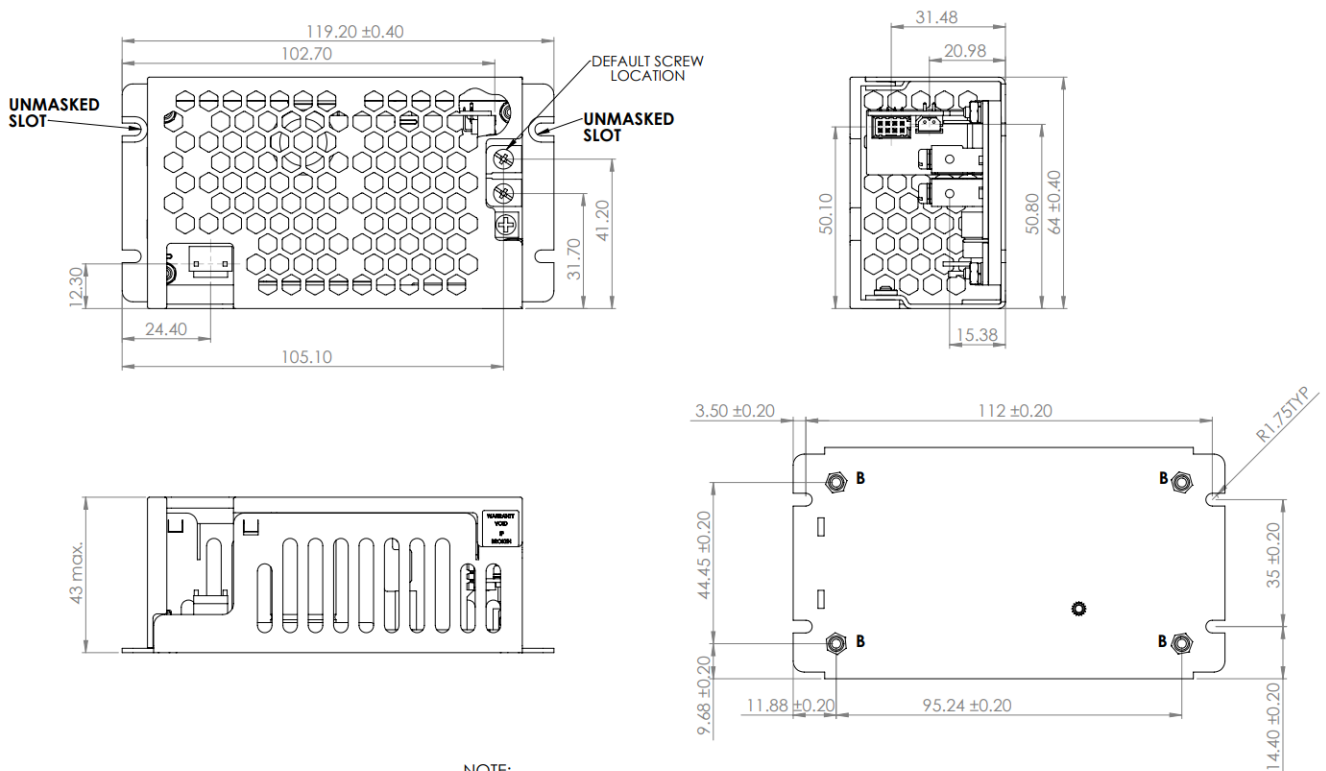

NOTE:
 1. "B" HOLES 4 X M3 FIXING . MAX PENETRATION 3.75mm. RECOMMENDED TORQUE 0.5-0.6Nm
 2. ALL UNSTATED TOLERANCES ± 0.4mm

F Option (U Channel, Cover and Top Mounted Fan)

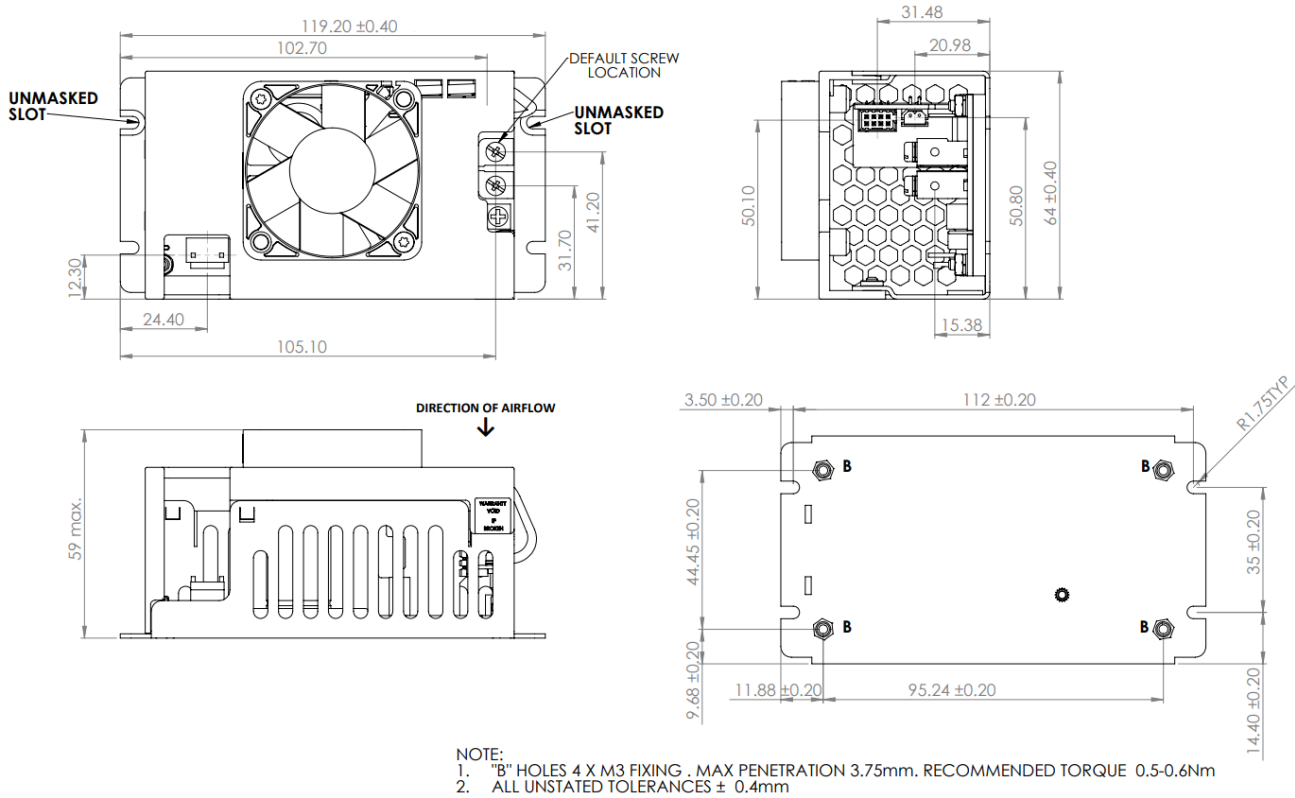

Mounting

Customer fixings must not bridge Creepage and Clearance distance spacing. Ensure the following creepages and clearances are maintained for customer fixing points

Based on IEC/EN/UL60950-1

- At 3000m operation, 2.3mm Clearance, 2.5mm creepage
- At 4000m operation, 2.6mm Clearance, 2.6mm creepage
- At 5000m operation, 3.0mm Clearance, 3.0mm creepage

IEC/EN/UL60601-1

- At 3000m operation, 2.5mm Clearance, 4mm creepage
- At 4000m operation, 2.9mm Clearance, 4mm creepage
- At 5000m operation, 3.3mm Clearance, 4mm creepage

IEC/EN/UL62368-1

- At 3000m operation, 1.8mm Clearance, 2.4mm creepage
- At 4000m operation, 2.0mm Clearance, 2.4mm creepage
- At 5000m operation, 2.3mm Clearance, 2.4mm creepage

All four mounting points should be used to support the unit.



TDK-Lambda UK Ltd
 Kingsley Avenue, Ilfracombe
 Devon, EX34 8ES
 Telephone - Sales and Service +44 (0)1271 856666
 Head Office and Works +44 (0)1271 856600
 Facsimile +44 (0)1271 864894
 WEBSITE: www.uk.tdk-lambda.com