

Type RLW73 Series

Key Features

Highly reliable multilayer electrode construction

High power to size ratio

High purity alumina substrate for high power dissipation

Long side terminations with higher power rating

Applications

Power Management Applications

Over Current Protection in Audio Applications

Voltage Regulation Module (VRM)

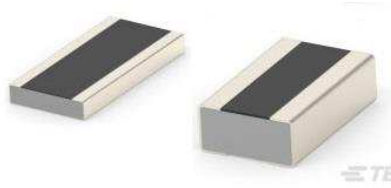

TE Connectivity (TE) is pleased to introduce this wide terminal cousin of our successful RL73 series current sense resistor. With reliable multilayer electrode construction, and high purity alumina substrate for high power dissipation, along with long side terminations, we can offer up to 3W in 1225 configuration with resistance values from 10mΩ ~ 750mΩ

Characteristics – Electrical

Standard Electrical Specification

Item Type	Size Code	Power Rating @70°C (W)	Maximum Operating Current (A)	Resistance Range (mΩ)		TCR (ppm/°C)
				1% E24/E96	5% E24	
RLW73	A2 0508	0.5	7.07	10-27(E24)		±600
				30- 510*		±200
RLW73	B2 0612	0.75	8.66	10-27(E24)		±600
				30- 510*		±200
RLW73	H2 1020	1.0	10	10-27(E24)		±600
				30- 750*		±200
RLW73	A3 1225	1.5	12.24	10-27(E24)		±600
				30- 750*		±200

*NB Values below 100mΩ only available in E24 series

High Power Rating Electrical Specifications

Item Type	Size Code	Power Rating @70°C (W)	Maximum Operating Current (A)	Resistance Range (mΩ)		TCR (ppm/°C)
				1% E24/E96	5% E24	
RLW73P	A2 0508	1.0	10	10-27(E24)		±600
				30- 510*		±200
RLW73P	B2 0612	1.5	12.2	10-27(E24)		±600
				30- 510*		±200
RLW73P	H2 1020	2.0	14.1	10-27(E24)		±600
				30- 750*		±200
RLW73P	A3 1225	3.0	17.3	10-27(E24)		±600
				30- 750*		±200

* NB Values below 100mΩ only available in E24 series

Operating Voltage= $v(P \cdot R)$; Overload Voltage= $2.5 \cdot v(P \cdot R)$; Operating Current= $v(P/R)$

Operating Temperature Range -55 ~ 155°C

Storage Temperature: 15~28°C; Humidity < 80%RH

Shelf Life: 2 years from production date.

Environmental Characteristics

Item	Requirement	Test Methods
Temperature Coefficient of Resistance (T.C.R.)	As Spec.	JIS C 5201-1 4.8 IEC 60115-1 4.8 At 25°C/-55°C and 25°C/+125°C, 25°C is the reference temperature
Short Time Overload	$\pm(2.0\%+0.05\Omega)$	JIS C 5201-1 4.13 IEC 60115-1 4.13 RCWV*2 for 5 seconds
Insulation Resistance	$\geq 10G$	JIS C 5201-1 4.6 IEC 60115-1 4.6 Max. Overload Voltage for 1 minute
Endurance	$\pm(2.0\%+0.05\Omega)$	JIS-C-5201-1 4.25 IEC-60115-1 4.25.1 70°C \pm 2°C,RCWV for 1000 hrs with 1.5 hrs "ON" and 0.5 hr "OFF"
Damp Heat with Load	$\pm(2.0\%+0.05\Omega)$	JIS-C-5201-1 4.24 IEC-60115-1 4.24 40 \pm 2°C,90~95% R.H.,RCWV for 1000hrs with 1.5 hrs "ON" and 0.5 hr "OFF"
Dry Heat	$\pm(1.0\%+0.05\Omega)$	JIS-C-5201-1 4.23 IEC-60115-1 4.23.2 at +155°C for 1000 hrs
Bending Strength	$\pm(1.0\%+0.05\Omega)$	JIS-C-5201-1 4.33 IEC-60115-1 4.33 Bending once for 60 seconds with 3mm
Solderability	95% min. coverage	JIS C 5201-1 4.17 IEC 60115-1 4.17 245 \pm 5°C for 3 seconds
Resistance to Soldering Heat	$\pm(1.0\%+0.05\Omega)$	JIS C 5201-1 4.18 IEC 60115-1 4.18 260 \pm 5°C for 10 seconds
Voltage Proof	No breakdown or flashover	JIS C 5201-1 4.7 IEC 60115-1 4.7 1.42 times Max. Operating Voltage for 1 minute RL73WA2:300V RL73WB2/H2/A3:400V
Leaching	Individual leaching area $\leq 5\%$ Total leaching area $\leq 10\%$	JIS C 5201-1 4.18 IEC 60068-2-58 8.2.1 260 \pm 5°C for 30 seconds
Rapid Change of Temperature	$\pm(0.5\%+0.05\Omega)$	JIS-C-5201-1 4.19 IEC-60115-1 4.19 -55°C (30 minutes) / +125°C (30 minutes) , 5 cycles

Derating Curve

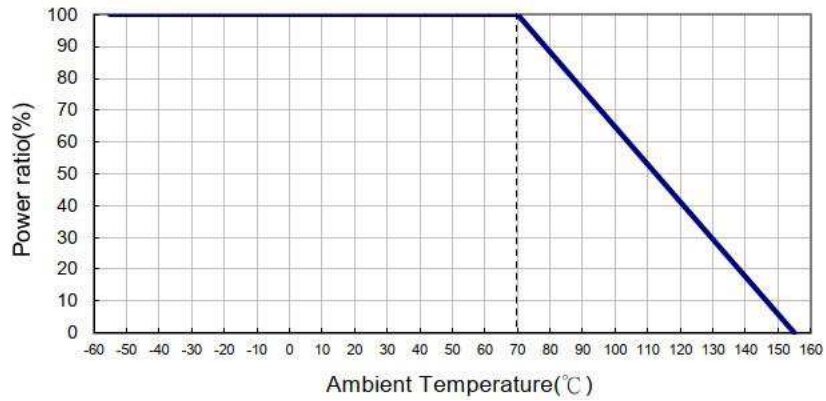

Construction and Dimensions

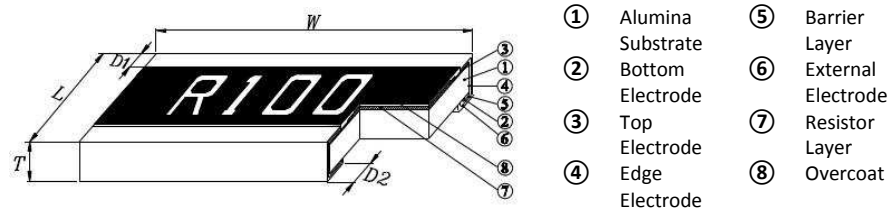

Type	Size	L (mm) ±0.15	W (mm) ±0.15	T (mm) ±0.10	D1 (mm) ±0.20	D2 (mm) ±0.15	Weight (g/1000)
RLW73A2	0508	1.25	2.00	0.60	0.30	0.35	6
RLW73B2	0612	1.60	3.20	0.60	0.30	0.45	12
RLW73H2	1020	2.50	5.00	0.60	0.40	0.75	35
RLW73A3	1225	3.10	6.30	0.60	0.45	0.75	48

Recommended Land Pattern

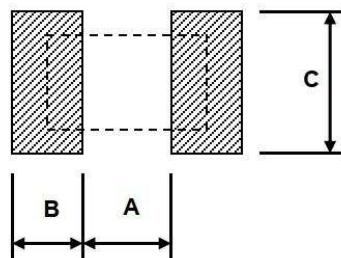

Type	A (mm)	B (mm)	C (mm)
RLW73A2	0.55	0.90	2.00
RLW73B2	0.70	0.80	3.20
RLW73H2	1.00	1.30	5.00
RLW73A3	1.60	1.20	6.40

Soldering Condition (Ref. IPC/JEDEC J-STD-020 & J-STD-002)

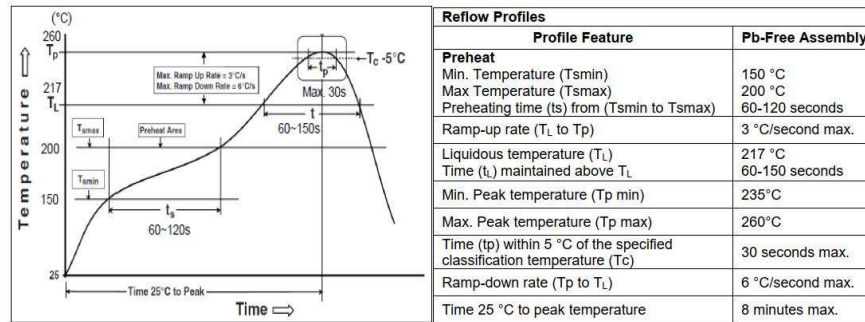

Marking

4 digits marking for all sizes

Example

Resistance	10mΩ	100mΩ
Marking	R010	R100

Packaging

Reel Quantity and Specification

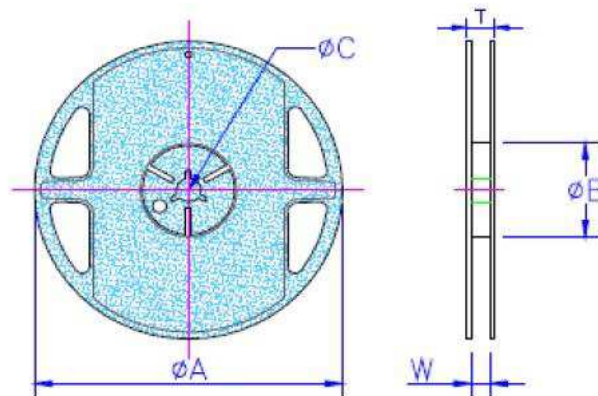

Size	ØA (mm) ±1.0	ØB (mm) ±1.0	ØC (mm) ±0.7	W (mm) ±1.0	T (mm) ±1.0	Paper Tape	Plastic Tape
0508	178.0	60.0	13.5	9.5	11.5	5000 / 1000	
0612	178.0	60.0	13.5	9.5	11.5	5000 / 1000	
1020	178.0	60.0	13.5	13.5	15.5		4000 / 1000
1225	178.0	60.0	13.5	13.5	15.5		4000 / 1000

Paper Tape Specifications

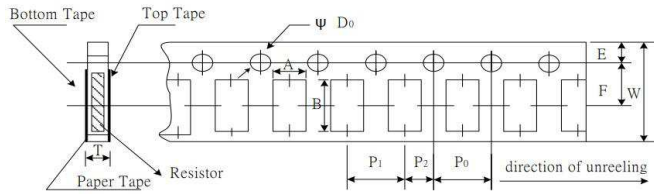

Size	A (mm) ±0.10	B (mm) ±0.20	W (mm) ±0.20	E (mm) ±0.10	F (mm) ±0.05	P ₀ (mm) ±0.10	P ₁ (mm) ±0.05	P ₂ (mm) ±0.05	∅D ₀ (mm) +0.1/ -0	T (mm) ±0.10
0508	1.60	2.40	8.00	1.75	3.50	4.00	4.00	2.00	1.50	0.85
0612	1.90	3.50	8.00	1.75	3.50	4.00	4.00	2.00	1.50	0.85

Embossed Plastic Tape Specification

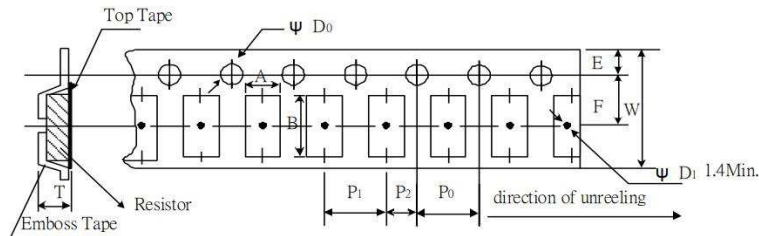

Size	A (mm) ±0.10	B (mm) ±0.20	W (mm) ±0.30	E (mm) ±0.10	F (mm) ±0.05	P ₀ (mm) ±0.10	P ₁ (mm) ±0.10	P ₂ (mm) ±0.05	∅D ₀ (mm) ±0.10	T (mm) ±0.20
1020	2.80	5.40±0.20	12.00	1.75	5.50±0.05	4.0±0.05	4.00	2.00	1.50	1.00
1225	3.38	6.68±0.10	12.00	1.75	5.50±0.10	4.0±0.10	4.00	2.00	1.50	1.00

How To Order

RLW73	A2	F	R047	TD
Common Part	Size Code	Resistance Tolerance	Resistance Value	Packaging
RLW73 – Wide Terminal Current Sense Resistor	A2 – 0508 B2 – 0612 H2 – 1020	F – 1% J – 5%	10mΩ - R010 100mΩ-R100	TD – Reel 5K (0508 & 0612) TDF – Reel 1K TE – Reel 4K (1020 & 1225)
RLW73P – High Power Wide Terminal Current Sense Resistor	A3 – 1225			

While TE has made every reasonable effort to ensure the accuracy of the information in this brochure, TE does not guarantee that it is error-free, nor does TE make any other representation, warranty or guarantee that the information is accurate, correct, reliable or current. TE reserves the right to make any adjustments to the information contained herein at any time without notice. TE expressly disclaims all implied warranties regarding the information contained herein, including, but not limited to, any implied warranties of merchantability or fitness for a particular purpose. The dimensions in this catalog are for reference purposes only and are subject to change without notice. Specifications are subject to change without notice. Consult TE for the latest dimensions and design specifications.