

1591XXCFL Enclosure

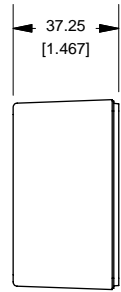

SIDE VIEW OF BOX

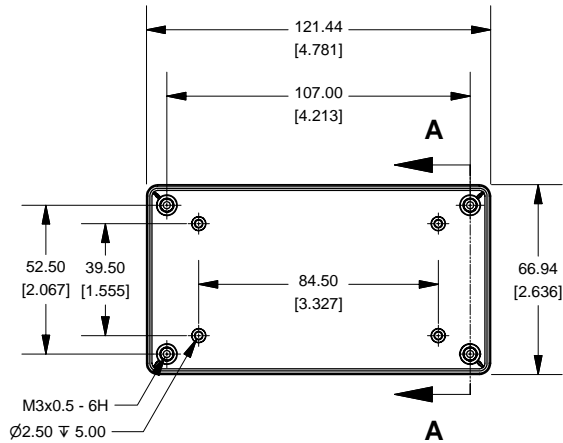

TOP VIEW OF BOX

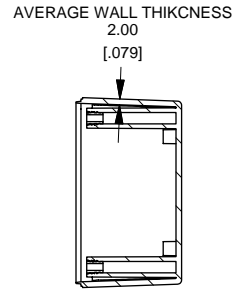

SECTION A-A
SCALE 3 / 8

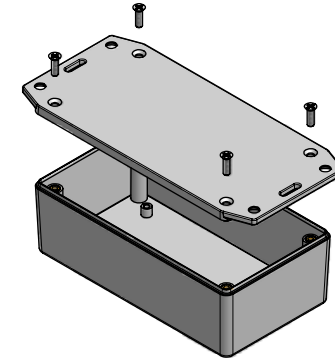

EXPLODED VIEW OF ENCLOSURE

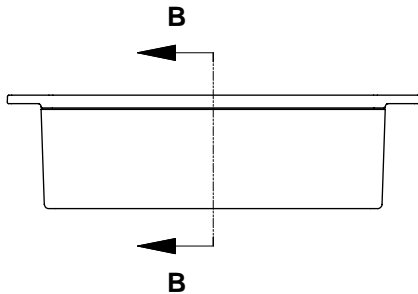

SIDE VIEW OF ENCLOSURE

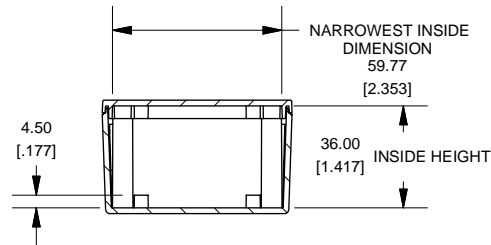

SECTION B-B
SCALE 3 / 8

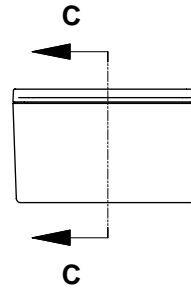

SIDE VIEW OF ENCLOSURE

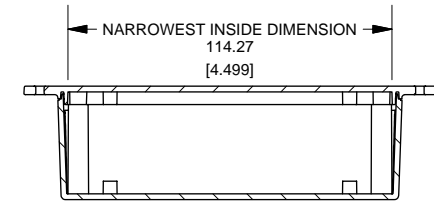

SECTION C-C
SCALE 3 / 8

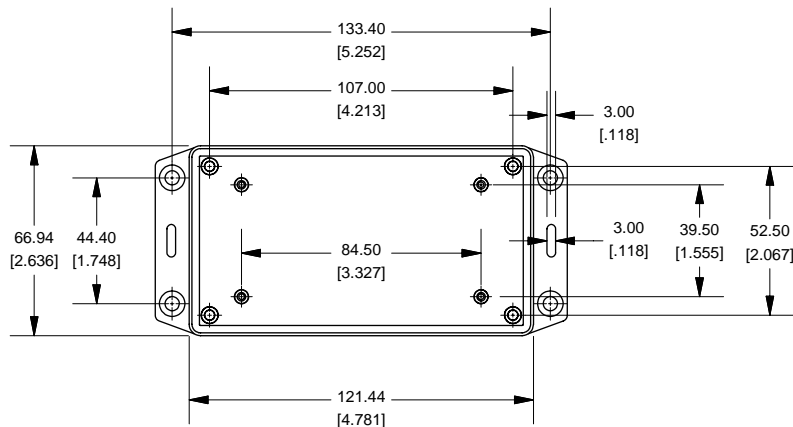

BOTTOM VIEW OF LID

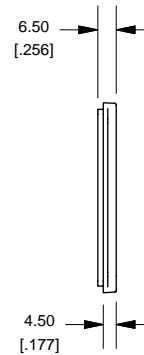

SIDE VIEW OF LID

NOTE
Purchased assembly includes lid and box made from FRABS 94-V0 material and cover screws.

1591XXCFL	
1591XXCFL Enclosure	
Flame Retardant ABS (UL94-V0)	
Black Enclosure - RAL 7011	1591XXCFLBK
ACCESSORIES	
For Flame Retardant ABS (UL94-V0)	
Black Enclosure Cover Screws (Pkg 100) [Machine Type M3-0.5 X 10mm]	1591MS100BK
P.C. Board Screws (All Boxes)	
P.C. Board Screws [#4 x 1/4" self-tapping (6.4mm)]	1593ATS50 (Pkg 50) 1593ATS100 (Pkg 100)



www.hammondmfg.com