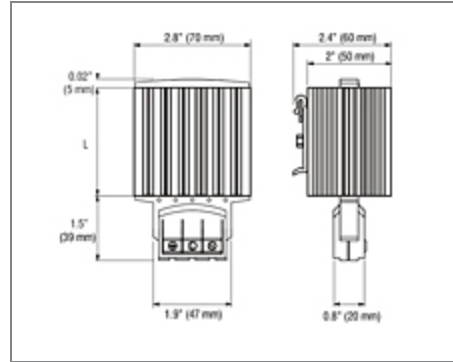

**Stego, Inc.**

1395 South Marietta Parkway

Building 800

Marietta, GA 30067, USA

Toll-Free: (888) 783-4611 • **Phone:** (770) 984-0858**Fax:** (770) 984-0615**Email:** info@stegousa.com • **Website:** www.stegousa.com**Part # 14015.0-00, PTC Heater****Specifications | [Technical Data](#)****Specifications**

Power¹	100 W
Voltage	12 - 30 VAC/VDC
Max. Current	7.4 A (inrush)

Technical Data

Heating Element	PTC resistor, temperature limiting
Heating Body	Anodized extruded aluminum
Connection	Push-type terminals for stranded and solid wire 3 x AWG 20-16 (0.5-1.5 mm ²)
Mounting	Clip for 35 mm DIN rail (EN 60 715)
Position	Preferably vertical
Dimensions	7.2 x 2.8 x 2.4 inches (179 x 70 x 60 mm)
Weight	14.3 oz (405 g)
Operating/Storage Temperature	-49 to 158 °F (-45 to 70 °C)

Protection Type	IP20
Protection Class	I (grounded)

¹ at 68° F (20° C) ambient temperature