

R & S® ESSENTIALS

CATALOG 2023 TEST & MEASUREMENT



R&S® ESSENTIALS | CATALOG 2023 | TEST & MEASUREMENT | 12.00

ROHDE & SCHWARZ

Make ideas real



CONTENTS

Chapter	Page
Company profile	2
Our business fields	2
Test equipment for your bench from R&S®ESSENTIALS	3
Explanation of icons	4
Featured products	5
Learn more	5
Oscilloscopes	7
Oscilloscope portfolio	9
Oscilloscope probe compatibility	21
Power supplies	23
Power supply portfolio	25
Signal generators	41
Signal generator hardware and software options	42
Handheld analyzers	47
Handheld analyzer portfolio	49
Spectrum analyzers	61
Economy spectrum analyzer portfolio	63
Vector network analyzers	71
Vector network analyzer portfolio	73
Meters and counters	79
You're in great hands.	83
Calibration you can trust	99
Rohde&Schwarz calibration versus third-party calibration	100
Service	85
Contact information	86
Trademarks	86

ONE GROUP, THREE DIVISIONS, DIVERSE MARKETS

We strongly identify with customer needs and develop leading technology solutions for a safer and connected world.

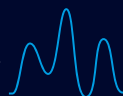

TEST & MEASUREMENT

- ▶ Wireless Communications
- ▶ Industry, Components & Research
- ▶ Aerospace & Defense Testing
- ▶ Automotive



TECHNOLOGY SYSTEMS

- ▶ Secure Communications
- ▶ Critical Infrastructure & Networks
- ▶ Government
- ▶ IP Network Analytics
- ▶ Broadcast, Amplifiers & Media



NETWORKS & CYBERSECURITY

- ▶ Network & Security Solutions
- ▶ Certified & High-Grade Crypto Solutions

TEST EQUIPMENT FOR YOUR BENCH FROM R&S®ESSENTIALS

Do you know what separates average test equipment from superior? We can sum it up in just one word: **Easy.** R&S®ESSENTIALS test instruments are easy to configure, easy to purchase and easy to use.

Configuring and purchasing these comprehensive and affordable test instruments has never been easier. With the help of the online configurator, you can quickly put together the exact product you need for your test setup, including options and accessories.

For the constantly growing R&S®ESSENTIALS portfolio, Rohde & Schwarz is extending its reach through a global network of test equipment distributors. With the help of these distribution partners, the company can simplify the purchasing experience for customers. You can pick the test instrument distributor when submitting your quote request. Rohde & Schwarz will take care of passing your request on for you to make sure that your application needs and test equipment budget are met. Our global network of authorized distribution partners also enables quick and easy purchase of test equipment online. Benefit from 24 h delivery, flexible payment options and other services of our distribution partners that enable simple access to test equipment.

Curious to get some practical tips from experts on specific measurements, learn more about the use of our test equipment in various application scenarios or receive guidance in choosing one of the R&S®ESSENTIALS test instruments? Visit our website now to get started.



EXPLANATION OF ICONS

In this catalog, the instrument interfaces are represented by icons on the first page (bottom left) of each product description. These icons are explained below.

Icon	Explanation
Remote control	
	USB The instrument can be connected to a PC via universal serial bus (USB) using a USB cable with a standard B type plug.
	Mini USB The instrument can be connected to a PC via universal serial bus (USB) using a USB cable with a mini-B type plug.
	Micro USB The instrument can be connected to a PC via universal serial bus (micro USB) using a micro USB cable.
	RS-232 The instrument is equipped with an RS-232 interface.
	TCP/IP The instrument is equipped with an Ethernet interface that can be connected to a local area network (LAN).
	IEEE-488 The instrument is equipped with an IEEE-488 interface, also referred to as general purpose interface bus (GPIB). This bus is widely used for controlling instruments in laboratories.
	WLAN The instrument can be remote controlled via a wireless local area network (WLAN).
Storage	
	USB flash drive The instrument is equipped with a universal serial bus (USB) upstream interface that can be used to connect a USB flash drive or other USB mass storage devices with a standard A type plug.
	Removable hard disk The instrument comes with a removable hard disk, e.g. for saving measurement results.
	SD card An SD card can be inserted, e.g. for saving measurement results.
	Micro SD card A micro SD card can be inserted, e.g. for saving measurement results.
Compatibility	
	LabVIEW The instrument can be controlled using the LabVIEW software from National Instruments.
Display	
	Screen Settings, results, etc. are shown on the integrated display (3.5" to 12.1").
	Touchscreen The user can control the instrument by touching the screen with a special pen and/or one or more fingers.
	DVI output An external monitor can be connected via a digital visual interface (DVI).
Miscellaneous	
	VGA output The instrument can be connected to a PC via the video graphics array (VGA) interface.
	Kensington The instrument can be locked with the Kensington lock.
	50 Ω
	1 MΩ
	The input impedance of the instrument can be switched between 50 Ω and 1 MΩ.

FEATURED PRODUCTS



R&S®MXO 4 oscilloscope

Featuring the world's fastest real-time update rate of 4.5 million waveforms per second, 12-bit ADC and 400 Mpoints per channel of standard acquisition memory, the R&S®MXO 4 series oscilloscope delivers a once-in-a-decade engineering breakthrough for accelerated insight.

▶ [page 19](#)



R&S®NGU source measure units

Thanks to their extremely high accuracy and fast load recovery time, R&S®NGU source measure units (SMU) are perfect for challenging applications. They provide a two- or four-quadrant architecture, allowing them to function both as a source and a sink to simulate batteries and loads.

▶ [page 39](#)



R&S®SMCV100B vector signal generator

The R&S®SMCV100B vector signal generator is the first multistandard platform for automotive, broadcast, navigation and wireless applications. This makes the R&S®SMCV100B unique for use in many applications, from the lab to production and wherever different technologies meet.

▶ [page 45](#)

LEARN MORE

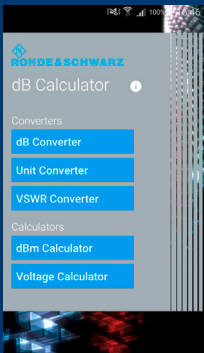

dB or not dB?

True or false: $30 \text{ dBm} + 30 \text{ dBm} = 60 \text{ dBm}$?

Why does 1% work out to be -40 dB one time, but 0.1 dB or 0.05 dB the next time? Sometimes even experienced engineers have trouble answering these questions. Decibels are found everywhere – in power levels, voltages, reflection coefficients, noise figures, field strengths and more. What is a decibel and how should we use it in our calculations? This application note provides a refresher on the subject of decibels.

▶ www.rohde-schwarz.com/appnote/1MA98

Get the highly rated calculator app for your everyday dB calculations now. Available on all platforms.



dB Calculator for Android



dB Calculator for iOS



dB Calculator for Windows Phone





R&S® LCX LCR meter

The R&S®LCX LCR meters are versatile, extremely accurate and perform measurements quickly. They are ideal for challenging applications in research, development and production. Two instrument models and various options cover applications with a test signal frequency of up to 10 MHz. Internal and external bias functions, comprehensive analysis options and versatile test fixtures expand the wide range of possible applications.

▶ [page 81](#)

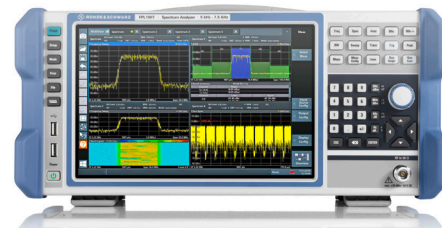

R&S®FPL1000 signal and spectrum analyzer

The R&S®FPL1000 is a single measuring instrument for a variety of measurement tasks. It supports spectrum analysis, highly accurate power measurement with power sensors and analysis of analog and digitally modulated signals.

▶ [page 69](#)



R&S®ZNL vector network analyzer

The R&S®ZNL helps reduce investment costs with a unique option concept. The base models support frequencies from 5 kHz up to 20 GHz, and the models up to 6 GHz can be extended with a fully integrated spectrum analyzer and support RF power meters. Furthermore, the spectrum analysis supports a CW signal generator option.

▶ [page 75](#)



RF & Bench Essentials Reference Guide

This guide includes a wide range of time-domain and RF test equipment. It covers most of the tools users want to understand in more detail.

This reference guide can also be a gateway to dig into some of the details contained in a more in-depth fundamental or primer guide on specific measuring instruments.

▶ www.rohde-schwarz.com/rf-essentials

Want to know the latest news from Rohde & Schwarz? Find us at



[linkedin.com/company/rohde-&-schwarz](https://www.linkedin.com/company/rohde-&-schwarz)



twitter.com/RohdeSchwarz



[youtube.com/user/RohdeundSchwarz](https://www.youtube.com/user/RohdeundSchwarz)



[facebook.com/RohdeAndSchwarz](https://www.facebook.com/RohdeAndSchwarz)

OSCILLOSCOPES

The Rohde & Schwarz oscilloscope portfolio offers options ranging from low-cost yet powerful 50 MHz oscilloscopes to full-featured 16 GHz oscilloscopes. Designed by the RF experts at Rohde & Schwarz, all oscilloscopes feature exceptional signal integrity, high value and excellent reliability.

Use the table on pages 9 and 10 to see the differences between each family.

Bandwidth

Bandwidth selection is typically the most crucial parameter when choosing an oscilloscope. Bandwidth is defined as the frequency at which a sine wave is attenuated by 3 dB or is approx. 30% smaller.

Since most signals are not sine waves (they look like square waves), you have to take into account the other frequency components that make up the signal. For example, you cannot measure a 1 GHz square wave with a 1 GHz oscilloscope – it will not look like a square wave.

Rule of thumb: $\text{Bandwidth}_{\text{Oscilloscope}} = 3 \text{ to } 5 \text{ times } f_{\text{clk}}$ of the test signal

The simplest way to determine how much bandwidth the oscilloscope needs is to take 3 to 5 times the clock frequency of the signal you want to measure. For example, a high-speed USB signal at 480 Mbit/s has a clock frequency of 240 MHz which would require a 720 MHz to 1.2 GHz oscilloscope.

Update rate

The update rate, sometimes called dead time or blind time, is how fast the oscilloscope can trigger on a waveform (basically one screen's worth of data), process it and then plot it on the display. The faster it can do this, the more likely you are to see infrequent events. The update rate is specified in waveforms per second or waveforms/s. For example, with an update rate of 50 000 waveforms/s, an oscilloscope captures a waveform every 20 μs . If the oscilloscope's timebase is set to acquire 100 ns of activity across the screen, the rest of that 20 μs (20 μs – 100 ns = 19.9 μs) is consumed by processing and plotting, which means the oscilloscope is dead for 99.5% of the time. If an infrequent anomaly happens during that dead time, the engineer will never see it.

Rule of thumb: Most engineers will want an update rate as fast as possible, assuming they do not have to trade off something else to get it (e.g. memory depth). If the engineer is just interested in single shot captures (e.g. power supply turn-on or low speed serial decode and trigger), then the update rate is not that important.

Sample rate

Sample rate and memory depth are directly related. The sample rate defines how fast the oscilloscope samples and digitizes the waveform. Those samples have to be stored somewhere, which is where memory is important. The more memory you have, the higher you can keep your sample rate (which allows you to take advantage of the full bandwidth of the oscilloscope).

Rule of thumb: You typically want the sample rate to be 5 times the bandwidth of the oscilloscope to accurately reproduce the signal. For example, for a 1 GHz oscilloscope, you need a sample rate of 5 Gsample/s. There are a few times that you can get by with less (down to 2.5 times), but in general, look for a sample rate at least 5 times the bandwidth.

As mentioned, memory depth is directly related to the sample rate. The more memory depth you have, the longer you can capture at high sample rates.

Rule of thumb: Most engineers will want as much memory as they can get to maximize the amount of time captured at high sample rate.

Vertical resolution

The vertical resolution is the number of buckets or vertical levels an oscilloscope can put voltages into for a waveform. When the oscilloscope is sampling the waveform, it does not have an infinite number of levels to put the sample in. It has to choose a level to put that sample in. The more levels it has to choose from, the more precise it can be. An 8-bit oscilloscope has 256 levels. A 10-bit oscilloscope has 1024. A 12-bit oscilloscope has 4096. A 16-bit oscilloscope has 65 536 levels.

Rule of thumb: In general, additional vertical resolution is most useful for signals where you are trying to see a small signal riding on top of a much larger signal. Without the additional levels, the small signal would be lost in the larger signal. Typically, larger signals are very slow in frequency.

Type	Designation	Page
R&S®ScopeRider RTH	Handheld oscilloscope	11
R&S®RTC1000	Oscilloscope	13
R&S®RTB2000	Oscilloscope	15
R&S®RTM3000	Oscilloscope	17
R&S®MXO 4	Series oscilloscope	19

Oscilloscope portfolio



	R&S®RTH1000	R&S®RTC1000	R&S®RTB2000	R&S®RTM3000
Vertical system				
Bandwidth ¹⁾	60/100/200/350/500 MHz	50/70/100/200/300 MHz	70/100/200/300 MHz	100/200/350/500 MHz/1 GHz
Number of channels	2 plus DMM/4	2	2/4	2/4
ADC resolution; system architecture	10 bit; 16 bit	8 bit; 16 bit	10 bit; 16 bit	10 bit; 16 bit
V/div, 1 MΩ	2 mV to 100 V	1 mV to 10 V	1 mV to 5 V	500 μV to 10 V
V/div, 50 Ω	–			500 μV to 1 V
Horizontal system				
Sampling rate per channel (in Gsample/s)	1.25 (4-channel model); 2.5 (2-channel model); 5 (all channels interleaved)	1; 2 (2 channels interleaved)	1.25; 2.5 (2 channels interleaved)	2.5; 5 (2 channels interleaved)
Maximum memory (per channel; 1 channel active)	125 kpoints (4-channel model); 250 kpoints (2-channel model); 500 kpoints	1 Mpoints; 2 Mpoints	10 Mpoints; 20 Mpoints	40 Mpoints; 80 Mpoints
Segmented memory	standard, 50 Mpoints	–	option, 320 Mpoints	option, 400 Mpoints
Acquisition rate (in waveforms/s)	50 000	10 000	50 000 (300 000 in fast segmented memory mode ²⁾)	64 000 (2 000 000 in fast segmented memory mode ²⁾)
Trigger				
Types	digital	analog	analog	analog
Sensitivity	–	–	at 1 mV/div: > 2 div	at 1 mV/div: > 2 div
Mixed signal option (MSO)				
Number of digital channels ¹⁾	8	8	16	16
Analysis				
Mask test	tolerance mask	tolerance mask	tolerance mask	tolerance mask
Mathematics	elementary	elementary	basic (math on math)	basic (math on math)
Serial protocols triggering and decoding ¹⁾	I ² C, SPI, UART/RS-232/RS-422/RS-485, CAN, LIN, CAN FD, SENT	I ² C, SPI, UART/RS-232/RS-422/RS-485, CAN, LIN	I ² C, SPI, UART/RS-232/RS-422/RS-485, CAN, LIN	I ² C, SPI, UART/RS-232/RS-422/RS-485, CAN, LIN, I ² S, MIL-STD-1553, ARINC 429
Applications ^{1), 2)}	high-resolution frequency counter, advanced spectrum analysis, harmonics analysis, user scripting	digital voltmeter (DVM), component tester, fast Fourier transform (FFT)	digital voltmeter (DVM), fast Fourier transform (FFT), frequency response analysis	power, digital voltmeter (DVM), spectrum analysis and spectrogram, frequency response analysis
Compliance testing ^{1), 2)}	–	–	–	–
Display and operation				
Size and resolution	7" touchscreen, 800 × 480 pixel	6.5", 640 × 480 pixel	10.1" touchscreen, 1280 × 800 pixel	10.1" touchscreen, 1280 × 800 pixel
General data				
Dimensions in mm (W × H × D)	201 × 293 × 74	285 × 175 × 140	390 × 220 × 152	390 × 220 × 152
Weight in kg	2.4	1.7	2.5	3.3
Battery	lithium-ion, > 4 h	–	–	–

¹⁾ Upgradeable.

²⁾ Requires an option.

³⁾ Available with future firmware release.



R&S® MXO 4

200/350/500 MHz/1/1.5 GHz

4

12 bit; 18 bit

500 µV to 10 V

500 µV to 1 V

2.5; 5 (2 channels interleaved)

standard: 400 Mpoints;
max. upgrade: 800 Mpoints²⁾

standard: 10 000 segments;
option: 1 000 000 segments

> 4 500 000

digital

0.0001 div, across full bandwidth, user controllable

16

³⁾

basic (math on math)

I²C, SPI, UART/RS-232/RS-422/RS-485, CAN, CAN FD, CAN XL³⁾, LIN³⁾

frequency response analysis

–

13.3" touchscreen,
1920 × 1080 pixel (Full HD)

414 × 279 × 162

6

–

R&S®Scope Rider RTH Handheld Oscilloscope



The perfect multipurpose tool for the lab or in the field.

When debugging embedded devices in the lab or analyzing complex problems in the field, the R&S®ScopeRider RTH offers the performance and capabilities of a lab oscilloscope as well as the form factor and ruggedness of a battery-operated handheld device.

Model overview

Model	Bandwidth	Channel (analog/digital)	Sample rate (analog/digital)	Memory depth	Update rate	Vertical resolution
R&S®RTH1002	60 MHz	2/8 (optional)	5 Gsample/s/1.25 Gsample/s	up to 12.5 Msample	50000 waveforms/s	up to 10 bit
R&S®RTH1012	100 MHz					
R&S®RTH1022	200 MHz					
R&S®RTH1032	350 MHz					
R&S®RTH1052	500 MHz					
R&S®RTH1004	60 MHz	4/8 (optional)	5 Gsample/s/1.25 Gsample/s	up to 12.5 Msample	50000 waveforms/s	up to 10 bit
R&S®RTH1014	100 MHz					
R&S®RTH1024	200 MHz					
R&S®RTH1034	350 MHz					
R&S®RTH1054	500 MHz					

Important facts

Specification	R&S®Scope Rider RTH	Why this is important
Update rate	50 000 waveforms/s	The faster the update rate, the faster users can find infrequent events.
Memory depth	up to 12.5 Msample	Allows capture of the longest period of time at high sample rate.
Integration	DMM, MSO, protocol analyzer, data logger	Allows debugging of low speed serial devices and mixed signal designs.
ADC resolution	10 bit	Allows users to see more detail and smaller signals.
Display	7", 800 x 480, touchscreen	Makes it easier to operate and see information on the display.

Scope of delivery

- ▶ User manual
- ▶ Power cord
- ▶ USB cable
- ▶ Passive probes for each channel

Recommended options/accessories

Description	Type
Hardware options (plug-in)	
Mixed signal option, 250 MHz, 8 digital channels	R&S®RTH-B1
Software options	
I ² C/SPI serial decoding	R&S®RTH-K1
UART/RS-232/RS-422/RS-485 serial decoding	R&S®RTH-K2
CAN/LIN serial triggering and decoding	R&S®RTH-K3

Recommended options/accessories

Description	Type
Spectrum analysis	R&S®RTH-K18
Advanced triggering	R&S®RTH-K19
Frequency counter	R&S®RTH-K33
Harmonics analysis	R&S®RTH-K34
User scripting	R&S®RTH-K38
Wireless LAN	R&S®RTH-K200/ R&S®RTH-K200US
Web interface remote control	R&S®RTH-K201
Probes	
Passive probe, 500 MHz, 10:1, isolated, 600 V CAT IV, 1000 V CAT III	R&S®RT-ZI10
Passive probe, 500 MHz, 100:1, isolated, 600 V CAT IV, 1000 V CAT III	R&S®RT-ZI11
Current probe, 100 kHz, 30 A, AC/DC	R&S®RT-ZC03



The perfect choice for:	
Electrical and electromechanical installation and maintenance	Education
Electronic field service and maintenance	Debugging and testing advanced power electronics

Your benefit	Features
Superior performance	<ul style="list-style-type: none"> ▶ Deep memory (up to 50 Msample) and high resolution (5 Gsample/s) ▶ Fast acquisition rate: 50 000 waveforms/s ▶ 10-bit ADC ▶ Excellent sensitivity: 2 mV/div to 100 V/div ▶ Up to 200 V offset range ▶ 37 automatic measurement functions
Outstanding protection and excellent connectivity	<ul style="list-style-type: none"> ▶ Isolated channels: CAT IV 600 V/CAT III 1000 V ▶ IP51 housing that meets military requirements ▶ Wireless LAN and Ethernet for web based remote control and quick data access
8 instruments in one handheld package	<ul style="list-style-type: none"> ▶ Lab performance oscilloscope ▶ Logic analyzer ▶ Protocol analyzer ▶ Data logger ▶ Digital multimeter¹⁾ ▶ Spectrum analyzer ▶ Harmonics analyzer ▶ Frequency counter

¹⁾ Additional multimeter channel in two-channel model.



The high-speed acquisition system of the R&S®ScopeRider RTH captures up to 50 000 waveforms/s and uncovers rare and unexpected signal anomalies

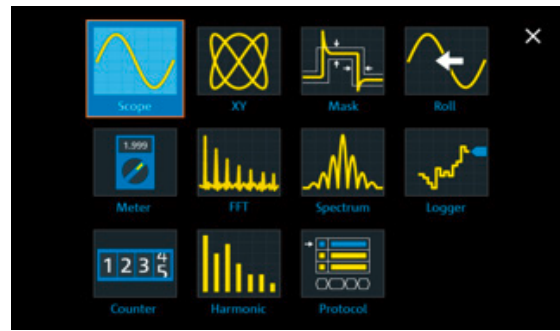

8 instruments in one: users can select the instrument they need at the push of a button

10-bit A/D converter: uncovers even small signal details

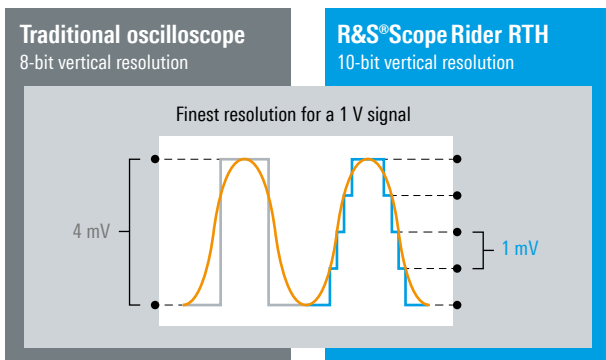

Double insulation for maximum safety

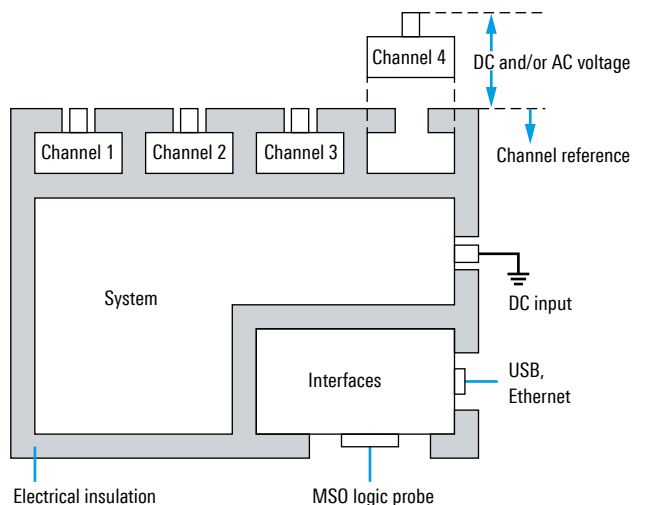

R&S®RTC1000 Oscilloscope

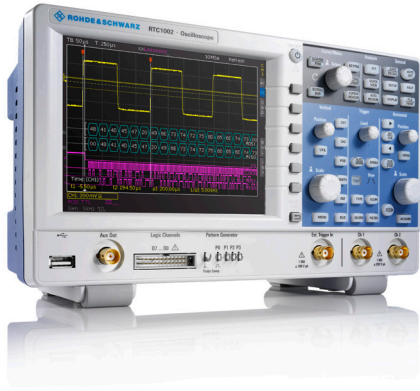

Get your results quicker

What sets these oscilloscopes apart from all others in their class? New, advanced technology:

- ▶ Low-noise frontend for best results
- ▶ X-in-1 instrument that offers the functionality of an oscilloscope, logic analyzer, protocol analyzer, frequency analyzer, pattern generator, function generator, digital voltmeter and component tester

Model overview

Model	Bandwidth	Channel (analog/digital)	Consists of	Max. sample rate (analog/digital)	Max. memory depth
R&S®RTC1002	50 MHz		R&S®RTC1000		
R&S®RTC1K-72	70 MHz		R&S®RTC1000 + R&S®RTC-B220		
R&S®RTC1K-102	100 MHz	2	R&S®RTC1000 + R&S®RTC-B221	2 Gsample/s	2 Msample
R&S®RTC1K-202	200 MHz		R&S®RTC1000 + R&S®RTC-B222		
R&S®RTC1K-302	300 MHz		R&S®RTC1000 + R&S®RTC-B223		
R&S®RTC1K-52M	50 MHz	2/8	R&S®RTC1000 + R&S®RTC-B1	2 Gsample/s/0.5 Gsample/s	2 Msample/0.5 Msample
R&S®RTC1K-72M	70 MHz		R&S®RTC1000 + R&S®RTC-B220 + R&S®RTC-B1		
R&S®RTC1K-102M	100 MHz		R&S®RTC1000 + R&S®RTC-B221 + R&S®RTC-B1		
R&S®RTC1K-202M	200 MHz		R&S®RTC1000 + R&S®RTC-B222 + R&S®RTC-B1		
R&S®RTC1K-302M	50 MHz		R&S®RTC1000 + R&S®RTC-B223 + R&S®RTC-B1		

Important facts

Specification	R&S®RTC1000	Why this is important
Bandwidth	50/70/100/200/300 MHz (upgradeable, configurable)	Upgradeable bandwidth up to 300 MHz provides investment protection for future requirements.
Max. memory depth	2 Msample	Allows capture of the longest period of time at high sample rate.
Mixed signal option (MSO)	8 channels, upgradeable, 0.5 Gsample/s, 0.5 Msample	Ideal for analysis of digital buses and correlation with analog signals.
Multifunctional	DVM, counter, waveform generator, pattern generator, component tester	Saves desk space and is a smart investment.

Scope of delivery

- ▶ User manual
- ▶ Power cord
- ▶ R&S®RT-ZP03 single-ended passive probes for each channel

Recommended options/accessories

Description	Type
Hardware options	
Mixed signal upgrade for non-MSO models, 250 MHz	R&S®RTC-B1
Arbitrary waveform generator	R&S®RTC-B6
Software options	
I ² C/SPI serial decoding	R&S®RTC-K1
UART/RS-232/RS-422/RS-485 serial decoding	R&S®RTC-K2
CAN/LIN serial triggering and decoding	R&S®RTC-K3
Application bundle (R&S®RTC-K1, -K2, -K3, -B6)	R&S®RTC-PK1
Option bundle	
Soft carrying bag	R&S®RTC-Z3
Rackmount kit	R&S®ZZA-RTC1K



The perfect choice for:	
R&D troubleshooting	Education
Production tests and repair	Electronic hobbyists

Your benefit	Features
Get your results quicker	Fast boot and auto measurement for concise and comprehensive results
Investment protection	Expandable to your needs through software licenses
Compactness saves desk space	Highest integration of instruments in a small form factor



X-in-1 oscilloscope

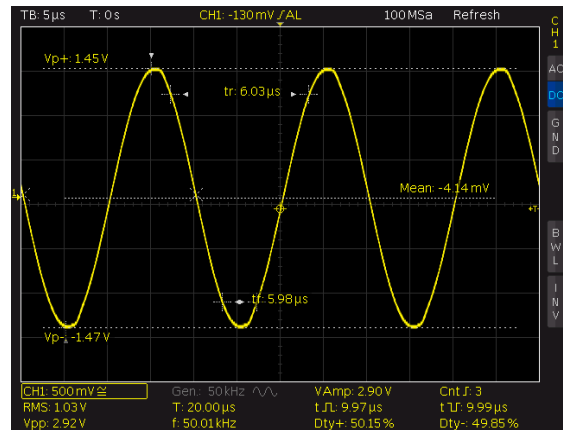

QuickView: automatic measurement and graphical display at the push of a button

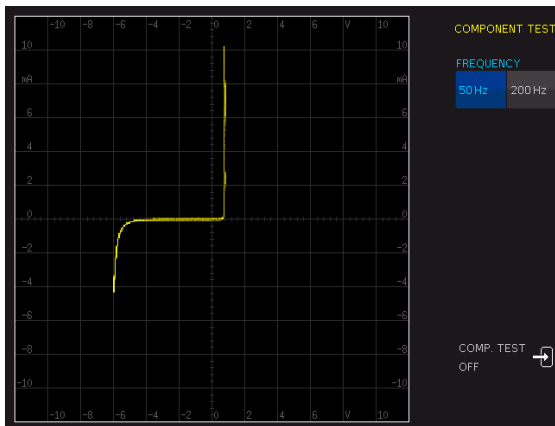

Quickly assess your components with the integrated tester

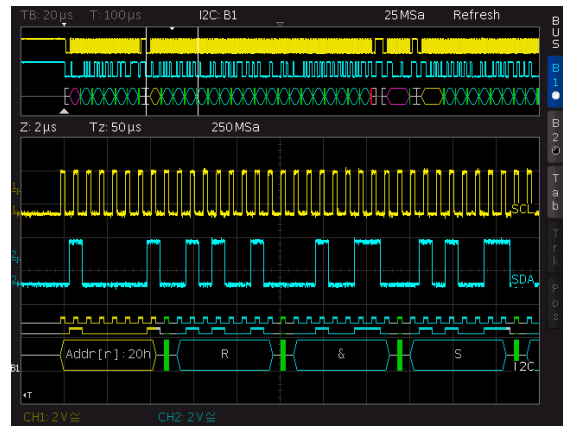

Gather insight into the digital communications on your circuitry

R&S®RTB2000 Oscilloscope



Read the review from one of the RoadTesters at Element14



More signal details with the power of 10

What sets these oscilloscopes apart from all others in their class? New, advanced technology:

- ▶ 10-bit ADC – see small signal details in the presence of large signals
- ▶ 10 Msample acquisition memory depth on each channel (20 Msample when interleaved)
- ▶ Large 10.1" high-resolution capacitive touchscreen with gesture support

Model overview

Model	Bandwidth	Channel (analog/digital)	Sample rate (analog/digital)	Memory depth	Update rate	Vertical resolution
R&S®RTB2002	70 MHz	2/16 (optional)	2.5 Gsample/s/1.25 Gsample/s	up to 160 Msample	50 000 waveforms/s	10 bit
R&S®RTB2004	70 MHz	4/16 (optional)	2.5 Gsample/s/1.25 Gsample/s	up to 160 Msample	50 000 waveforms/s	10 bit

Important facts

Specification	R&S®RTB2000	Why this is important
Bandwidth	70/100/200/300 MHz (upgradeable)	Upgradeable bandwidth up to 300 MHz provides investment protection for future requirements.
ADC resolution	10 bit	Allows users to see more detail and smaller signals.
Max. memory depth	20 Msample (160 Msample history)	Allows capture of the longest period of time at high sample rate.
Display	10.1", 1280 × 800 pixel, capacitive touchscreen	Makes it easier to operate and see information on the display.
Update rate	50 000 waveforms/s	The faster the update rate, the faster users can find infrequent events.
Integration	DVM, counter, function generator, pattern generator, 16 channels MSO	Allows debugging of low speed serial devices and mixed signal designs.
Interfaces	USB, LAN with fast web browser and MTP	Remote control makes updating and monitoring of the instrument easy.

Scope of delivery

- ▶ Single-ended passive probes for each channel
- ▶ Power cord
- ▶ USB cable
- ▶ User manual
- ▶ 3 year warranty

Recommended options/accessories

Description	Type
Hardware options	
Mixed signal upgrade for non-MSO models, 300 MHz, incl. 2 × R&S®RT-ZL03	R&S®RTB-B1
Arbitrary waveform generator	R&S®RTB-B6
Software options	
I ² C/SPI serial triggering and decoding	R&S®RTB-K1
UART/RS-232/422/485 serial triggering and decoding	R&S®RTB-K2
CAN/LIN serial triggering and decoding	R&S®RTB-K3
History and segmented memory with 160 Msample	R&S®RTB-K15
Frequency response analysis (Bode plot)	R&S®RTB-K36
Application bundle (R&S®RTB-K1, -K2, -K3, -K15, -K36, -B6)	R&S®RTB-PK1



The perfect choice for:	
R&D troubleshooting	Education
Production tests and repair	Electronic hobbyists

Your benefit	Features
See small signal details in the presence of large signals	<ul style="list-style-type: none"> ▶ 10-bit ADC ▶ 1280 × 800 pixel display resolution
Capture more time at full bandwidth	<ul style="list-style-type: none"> ▶ 2.5 Gsample/s max. sample rate with up to 20 Msample memory ▶ 12 horizontal divisions
Easier to see and collaborate; faster to operate and interpret results	<ul style="list-style-type: none"> ▶ 10.1" capacitive touchscreen with 1280 × 800 resolution ▶ Grid annotation ▶ Split dual window

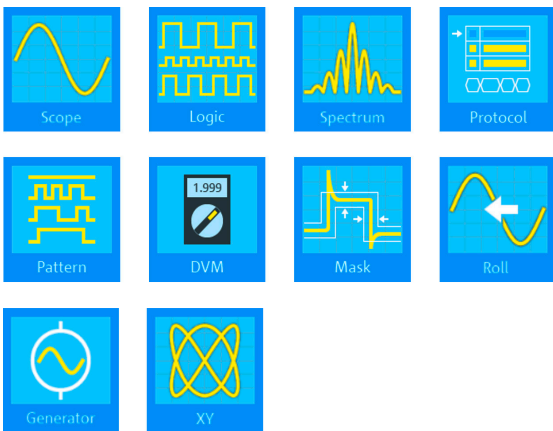

X-in-1 oscilloscope

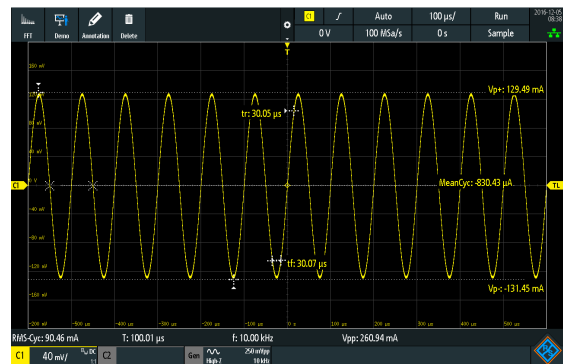

QuickMeas: automatic measurement and graphical display at the push of a button

10 to 160 times more memory depth compared to traditional oscilloscopes in the same instrument class

Capture the longest time periods with class-leading 160 Msample memory

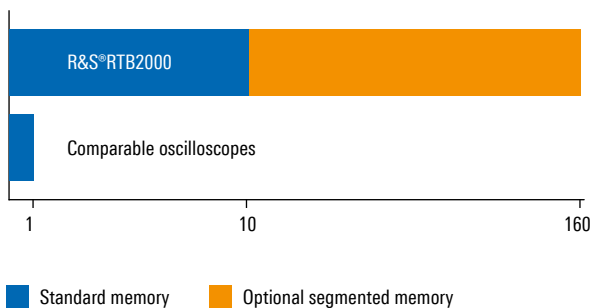

10-bit A/D converter: uncovers even small signal details

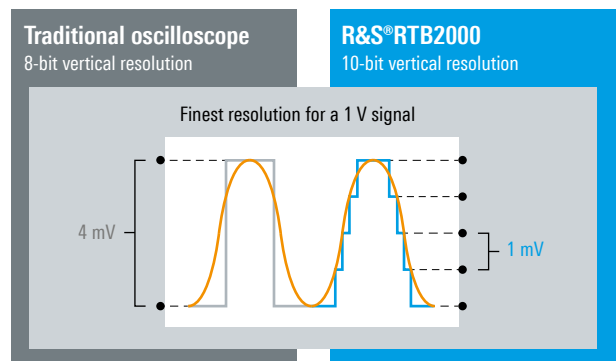

R&S®RTM3000 Oscilloscope



See more of your signal with the power of 10

What sets these oscilloscopes apart from all others in their class?
New, advanced technology:

- ▶ Large 10.1" capacitive touchscreen
- ▶ 10-bit ADC designed by Rohde&Schwarz
- ▶ 40 Msample (all channels) and 80 Msample (interleaved) acquisition memory depth
- ▶ 10 s boot time

Model overview

Model	Bandwidth	Channel (analog/digital)	Consists of	Max. sample rate (analog/digital)	Max. memory depth
R&S®RTM3002	100 MHz	2	R&S®RTM3002	5 Gsample/s	40 Msample/channel, 80 Msample interleaved standard, 400 Msample (optional)
R&S®RTM3004	100 MHz	4	R&S®RTM3004		
R&S®RTM3K-22	200 MHz	2	R&S®RTM3002 + R&S®RTM-B222		
R&S®RTM3K-24	200 MHz	4	R&S®RTM3004 + R&S®RTM-B242		
R&S®RTM3K-32	350 MHz	2	R&S®RTM3002 + R&S®RTM-B223		
R&S®RTM3K-34	350 MHz	4	R&S®RTM3004 + R&S®RTM-B243		
R&S®RTM3K-52	500 MHz	2	R&S®RTM3002 + R&S®RTM-B225		
R&S®RTM3K-54	500 MHz	4	R&S®RTM3004 + R&S®RTM-B245		
R&S®RTM3K-102	1 GHz	2	R&S®RTM3002 + R&S®RTM-B2210		
R&S®RTM3K-104	1 GHz	4	R&S®RTM3004 + R&S®RTM-B2410		
R&S®RTM3K-02M	100 MHz	2/16	R&S®RTM3002 + R&S®RTM-B1	5 Gsample/s/ 5 Gsample/s	
R&S®RTM3K-04M	100 MHz	4/16	R&S®RTM3004 + R&S®RTM-B1		
R&S®RTM3K-22M	200 MHz	2/16	R&S®RTM3002 + R&S®RTM-B222 + R&S®RTM-B1		
R&S®RTM3K-24M	200 MHz	4/16	R&S®RTM3004 + R&S®RTM-B242 + R&S®RTM-B1		
R&S®RTM3K-32M	350 MHz	2/16	R&S®RTM3002 + R&S®RTM-B223 + R&S®RTM-B1		
R&S®RTM3K-34M	350 MHz	4/16	R&S®RTM3004 + R&S®RTM-B243 + R&S®RTM-B1		
R&S®RTM3K-52M	500 MHz	2/16	R&S®RTM3002 + R&S®RTM-B225 + R&S®RTM-B1		
R&S®RTM3K-54M	500 MHz	4/16	R&S®RTM3004 + R&S®RTM-B245 + R&S®RTM-B1		
R&S®RTM3K-102M	1 GHz	2/16	R&S®RTM3002 + R&S®RTM-B2210 + R&S®RTM-B1		
R&S®RTM3K-10M	1 GHz	4/16	R&S®RTM3004 + R&S®RTM-B2410 + R&S®RTM-B1		

Important facts

Specification	R&S®RTM3000	Why this is important
Bandwidth	100/200/350/500/1000 MHz (upgradeable)	Upgradeable bandwidth up to 1 GHz provides investment protection for future requirements.
ADC resolution	10 bit	Allows users to see more detail and smaller signals.
Max. resolution	16 bit with high resolution or averaging	Allows users to see more detail and smaller signals.
Max. memory depth	80 Msample	Allows capture of the longest period of time at high sample rate.
Segmented memory/history	optional, 400 Msample	Ideal for burst signals. Allows capture of the longest time periods at a high sample rate without wasting memory on idle periods.
Display	10.1", 1280 × 800, capacitive touchscreen	Makes it easier to operate and see information on the display.
Hardware dynamic range, full bandwidth	▶ 1 MΩ: 0.5 mV to 10 V ▶ 50 Ω: 0.5 mV to 1 V	Smallest settings allow users to zoom in on small signals with full bandwidth. Largest settings allow users to properly scale a large waveform.
Boot time	approx. 10 s	Remote control makes updating and monitoring of the instrument easy.



The perfect choice for:	
R&D debugging power	R&D debugging serial buses
Manufacturing test and repair	Education

Your benefit	Features
Easier to see and collaborate; faster to operate and interpret results	10.1" capacitive touchscreen with 1280 × 800 resolution, Grid annotation, split dual window, SmartGrid
Capture more time at full bandwidth	5 Gsample/s max. sample rate with up to 80 Msample memory, 12 horizontal divisions, 400 Msample history mode
See small signal details in the presence of large signals	10-bit ADC. 10.1", 1280 × 800 pixel display resolution
Start working sooner	10 s boot time
Troubleshoot and solve a wide range of problems with one instrument	8 instruments in one: oscilloscope, logic analyzer, spectrum analyzer, protocol analyzer, arbitrary waveform generator, pattern generator, counter, digital voltmeter

Power highlights

- ▶ Analysis of the input, output and transfer functions of switched-mode power supplies
- ▶ Measurement wizard for fast results
- ▶ Simple and fast documentation
- ▶ Analysis of the harmonic current in line with conventional EN, MIL and RTCA standards

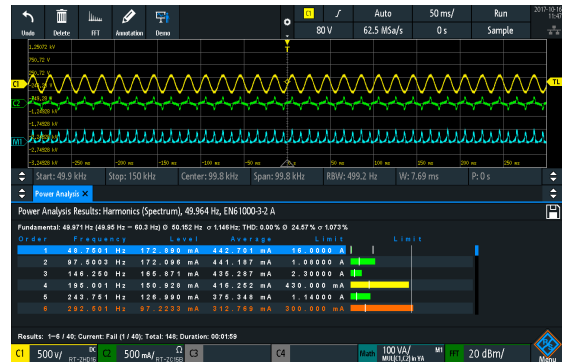

Power analysis measurement

Scope of delivery

- ▶ User manual
- ▶ Power cord
- ▶ R&S®RT-ZP05S single-ended passive probes for each channel

Recommended options/accessories

Description	Type
Hardware options	
Mixed signal upgrade for non-MSO models, 16 channels, 5 Gsample/s, up to 80 Msample	R&S®RTM-B1
Arbitrary waveform generator	R&S®RTM-B6
Software options	
I ² C/SPI triggering and decoding	R&S®RTM-K1
UART/RS-232/422/485 triggering and decoding	R&S®RTM-K2
History and segmented memory with 400 Msample	R&S®RTM-K15
Spectrum analysis and spectrogram	R&S®RTM-K37
Frequency response analysis (Bode plot)	R&S®RTM-K36
Application bundle ¹⁾ , consists of the following options: (R&S®RTM-K1, -K2, -K3, -K5, -K6, -K7, -K15, -K31, -K36, -K37, -B6)	R&S®RTM-PK1US

¹⁾ The R&S®RTM-PK1US option is only distributed in North America.

8 instruments in one

Oscilloscope	standard
Logic analyzer (16-channel MSO)	R&S®RTM-B1 MSO option, includes cabling, lead sets and grabbers
Protocol analyzer	options for different serial buses
Spectrum analyzer	R&S®RTM-K37 option with spectrogram
Integrated digital voltmeter	standard
Trigger counter	standard
Waveform generator (25 MHz)	R&S®RTM-B6 option
Pattern generator (4 bit)	R&S®RTM-B6 option

R&S®MXO 4 Series Oscilloscope



New

Next generation oscilloscope for accelerated insight

The R&S®MXO 4 series is the first of a new generation of oscilloscopes that excels in both performance and value. The instruments deliver a once-in-a-decade engineering breakthrough for accelerated insight.

- ▶ 200 MHz to 1.5 GHz bandwidth
- ▶ Up to 5 Gsample/s sample rate
- ▶ 400 Mpoints per channel standard memory
- ▶ 12-bit ADC at all sample rates
- ▶ 18-bit architecture with HD mode
- ▶ Precise digital trigger

Model overview

Model	Bandwidth	Channel	Sample rate	Maximum memory depth	Optional MSO
R&S®MXO44-242	200 MHz	4	5 Gsample/s	400 Mpoints per channel (optional 800 Mpoints)	16 digital channels
R&S®MXO44-243	350 MHz				
R&S®MXO44-245	500 MHz				
R&S®MXO44-2410	1 GHz				
R&S®MXO44-2415	1.5 GHz				

Important facts

Specification	R&S®MXO 4	Why this is important
Capture rate	> 4.5 million waveforms/s	Find signal anomalies quickly.
ADC resolution	12 bit (18-bit architecture with HD mode)	See your signals accurately.
Memory depth	standard: 400 Mpoints per channel; option: 800 Mpoints interleaved	Capture more time.
Trigger	Industry's most sensitive trigger: 0.0001 vertical division	Isolate events with more precision.

Scope of delivery

- ▶ Power cable
- ▶ Quick start guide
- ▶ 3 year warranty

Recommended options/accessories

Description	Type
Hardware options	
Mixed signal option (MSO) with 16 digital channels	R&S®MXO4-B1
Arbitrary waveform generator, 100 MHz, 2 channels	R&S®MXO4-B6
Memory upgrade to 800 Mpoints on 2 channels	R&S®MXO4-B108
Software options	
Low speed serial triggering and decoding (I ² C/SPI/UART/RS-232/RS-422/RS-485)	R&S®MXO4-K510
Automotive serial triggering and decoding (CAN/CAN FD/CAN XL ¹⁾ /LIN ¹⁾)	R&S®MXO4-K520
Frequency response analysis	R&S®MXO4-K36
Accessories	
Front cover	R&S®MXO4-Z1
Soft case	R&S®MXO4-Z3
Transit case	R&S®MXO4-Z4
19" rackmount kit, 6 HU	R&S®ZZA-MXO4



¹⁾ Available with future firmware release.

The perfect choice for:

- Hardware debugging; serial bus analysis
- Power analysis
- EMI debugging
- Power integrity



Your go-to tool:

- ▶ Wide range of analysis functions accelerated by hardware for real-time performance, including math, measurements, etc.
- ▶ 16 digital channels activated with R&S®MXO4-B1 probes that can be used simultaneously with all analog channels
- ▶ R&S®MXO4-B6 adds 2 integrated 100 MHz arbitrary waveform generators with a wide range of available waveform shapes
- ▶ Frequency response and impedance analysis are available with R&S®MXO4-K36, making the oscilloscope more versatile for power analysis



Serial bus analysis:

- ▶ Innovative dual-path protocol analysis for correct protocol packet decoding and triggering regardless of sample rate settings for waveform acquisitions
- ▶ Combined with deepest memory and segmentation, the R&S®MXO 4 captures longer durations of protocol events to help monitor and understand system behavior
- ▶ Search functionality helps finding events of interest in captured bus activity based on trigger or protocol content

Your benefit	Features
Find signal anomalies quickly	<ul style="list-style-type: none"> ▶ World's fastest acquisition rate of up to > 4.5 million waveforms/s reveals infrequent anomalies instantly ▶ Industry's fastest trigger rearm time of 21 ns
See your signals accurately	<ul style="list-style-type: none"> ▶ 12-bit ADC for high vertical resolution at all sample rates across the full bandwidth ▶ 18-bit architecture with HD mode ▶ Lowest noise of 104 μV at 1 GHz on 1 mV/div sensitivity ▶ Vertical sensitivity to 500 μV/div with \pm5 V offset range
Capture more time	<ul style="list-style-type: none"> ▶ Industry's deepest memory of 400 Mpoints per channel (optionally 800 Mpoints interleaved) ▶ History and segmentation memory to capture up to 1 million acquisitions
Isolate events with more precision	<ul style="list-style-type: none"> ▶ Industry's most sensitive trigger: 0.0001 vertical division ▶ Best in class trigger jitter of just 1 ps ▶ Adjustable digital trigger filters

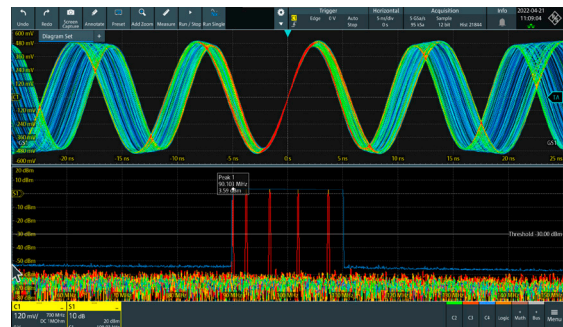

Spectrum analysis:

- ▶ Hardware accelerated processing with an industry leading spectrum acquisition rate of 45 000 FFT/s, ideal for capturing spurious and random spectrum events
- ▶ RF and time domain views with independent control allows intuitive setup while remaining time-correlated
- ▶ Pristine RF spectrum performance with peak list and max./min. hold traces makes R&S®MXO 4 perfect for EMI debugging

Probe choices

Rohde & Schwarz offers a wide variety of probe choices for your applications including:

- ▶ Active single-ended and differential probes
- ▶ High voltage and current probes
- ▶ Power rail probes
- ▶ Logic probes
- ▶ Near-field probes

Visit our probe portfolio to find out more:



Oscilloscope probe compatibility

Sensor	Oscilloscope (R&S®)				
	RTH	RTC1000	RTB2000	RTM3000	MXO 4
Passive probes					
R&S®RT-ZP1X, 1:1, 38 MHz, 1 MΩ, 39 pF	○	○	○	○	○
R&S®RT-ZP03, 10:1/1:1, 300 MHz/10 MHz, 10 MΩ/1 MΩ, 12 pF/82 pF		●	●	○	○
R&S®RT-ZP05S, 10:1, 500 MHz, 10 MΩ, 9.5 pF		○	○	●	○
R&S®RTM-ZP10, 500 MHz, 10 MΩ, 9.5 pF		○	○	○	○
R&S®RT-ZP10, 10:1, 500 MHz, 10 MΩ, 9.5 pF		○	○	○	○
R&S®RT-ZP11, 10:1, 700 MHz, 10 MΩ, 9.5 pF					●
R&S®RT-ZI10, 500 MHz, 10 MΩ, 10:1, 12pF, 600 V CAT IV, 1000 V CAT III	●				
R&S®RT-ZI10C, 500 MHz, 10 MΩ, 10:1, 11 pF, 300 V CAT III	○				
R&S®RT-ZI11, 500 MHz, 10 MΩ, 100:1, 4.6 pF, 600 V CAT IV, 1000 V CAT III	○				
R&S®RT-ZZ80, 8.0 GHz, 500 Ω, 0.3 pF				○	○
Single-ended active probes					
R&S®RT-ZS10L, 1 GHz, 1 MΩ, 0.9 pF ¹⁾		○	○	○	○
R&S®RT-ZS10E, 1 GHz, 1 MΩ, 0.8 pF				○	○
R&S®RT-ZS10, 1 GHz, 1 MΩ, 0.8 pF, R&S®ProbeMeter				○	○
R&S®RT-ZS20, 1.5 GHz, 1 MΩ, 0.8 pF, R&S®ProbeMeter				○	○
R&S®RT-ZS30, 3 GHz, 1 MΩ, 0.8 pF, R&S®ProbeMeter				○	○
R&S®RT-ZS60, 6 GHz, 1 MΩ, 0.3 pF, R&S®ProbeMeter				○	○
R&S®RT-ZPR20, 2 GHz, power rail probe, R&S®ProbeMeter				○	○
R&S®RT-ZPR40, 4 GHz, power rail probe, R&S®ProbeMeter				○	○
Differential active probes					
R&S®RT-ZD10, 1 GHz, 1 MΩ, 0.6 pF, R&S®ProbeMeter, R&S®RT-ZA15 included				○	○
R&S®RT-ZD20, 1.5 GHz, 1 MΩ, 0.6 pF, R&S®ProbeMeter, R&S®RT-ZA15 optional				○	○
R&S®RT-ZD30, 3 GHz, 1 MΩ, 0.6 pF, R&S®ProbeMeter, R&S®RT-ZA15 optional				○	○
R&S®RT-ZD40, 4.5 GHz, 1 MΩ, 0.4 pF, R&S®ProbeMeter, R&S®RT-ZA15 optional				○	○
R&S®RT-ZM15 multimode, 1.5 GHz, 400 kΩ, modular, R&S®ProbeMeter					
R&S®RT-ZM30 multimode, 3 GHz, 400 kΩ, modular, R&S®ProbeMeter					
R&S®RT-ZM60 multimode, 6 GHz, 400 kΩ, modular, R&S®ProbeMeter					
R&S®RT-ZM90 multimode, 9 GHz, 400 kΩ, modular, R&S®ProbeMeter					
R&S®RT-ZMA50 extreme temperature kit for use with R&S®RT-ZMxx					
R&S®RT-ZA15 external attenuator (±70 V DC/±46 V AC (peak)) ²⁾				○	○

- Standard
- Optional/additional probes
- Recommended

¹⁾ Probes need 50 Ω input coupling. For oscilloscopes with only 1 MΩ input, a BNC feedthrough adapter is required.

²⁾ R&S®RT-ZA15 comes standard with the R&S®RT-ZD10.

Sensor	Oscilloscope (R&S®)				
	RTH	RTC1000	RTB2000	RTM3000	MXO 4
High voltage passive probes					
R&S®RT-ZH03, 250 MHz, 100:1, 850 V, passive		○	○	○	○
R&S®RT-ZH10, 400 MHz, 100:1, 1 kV, passive		○	○	○	○
R&S®RT-ZH11, 400 MHz, 1000:1, 1 kV, passive		○	○	○	○
High voltage differential probes					
R&S®RT-ZHD07, 200 MHz, 25:1 or 250:1, 750 V				○	○
R&S®RT-ZHD15, 100 MHz, 50:1 or 500:1, 1.5 kV				○	○
R&S®RT-ZHD16, 200 MHz, 50:1 or 500:1, 1.5 kV				○	○
R&S®RT-ZHD60, 100 MHz, 100:1 or 1000:1, 6 kV				○	○
Current probes					
R&S®RT-ZC02, 20 kHz, 100 A/1000 A	○	○	○	○	○
R&S®RT-ZC03, 100 kHz, 30 A	○	○	○	○	○
R&S®RT-ZC05B, 2 MHz, 500 A, Rohde&Schwarz probe interface				○	○
R&S®RT-ZC10, 10 MHz, 150 A ¹⁾	○	○	○	○	○
R&S®RT-ZC10B, 10 MHz, 150 A, Rohde&Schwarz probe interface				○	○
R&S®RT-ZC15B, 50 MHz, 30 A, Rohde&Schwarz probe interface				○	○
R&S®RT-ZC20, 100 MHz, 30 A ¹⁾	○	○	○	○	○
R&S®RT-ZC20B, 100 MHz, 30 A, Rohde&Schwarz probe interface				○	○
R&S®RT-ZC30, 120 MHz, 5 A ¹⁾	○	○	○	○	○
Near-field probes					
R&S®HZ-15, 9 kHz to 3 GHz ²⁾	○	○	○	○	○
R&S®HZ-16, preamplifier for near-field probes	○	○	○	○	○
R&S®HZ-17, 30 MHz to 3 GHz ²⁾	○	○	○	○	○
Accessories					
R&S®RT-ZA9, N type adapter for R&S®RT-Zxx probes	for use on spectrum and signal analyzer				
R&S®RT-ZA10, SMA adapter				○	○
R&S®RT-ZA13, power supply for current probes without Rohde&Schwarz probe interface		○	○	○	○
Rackmount kit		○	○	○	○

- Standard
- Optional/additional probes
- Recommended

¹⁾ Current probes without Rohde&Schwarz probe interface require R&S®RT-ZA13 power supply.

POWER SUPPLIES

Number of channels

Depending on the application and requirements, you can select a power supply unit with 1, 2, 3 or 4 channels.

In many cases, a single output will be sufficient. However, multi-output supplies can deliver important advantages in applications that require, for example, +15 V and –15 V simultaneously. A multi-output supply with independently controllable outputs is usually more versatile than a set of individual supplies. Using a single multi-output supply significantly reduces costs.

Output power

The maximum power is determined by the maximum voltage and current demanded by the device. All multichannel Rohde&Schwarz power supplies allow parallel and serial operation to achieve higher voltage/current output.

Readback accuracy and sense lines

Modern power supplies include a multimeter that measures the voltage/current consumed by the device under test (DUT). The readback accuracy specifies the accuracy of these measurements.

The output cables that connect a power supply's output to its load have some resistance, and as current flow increases there will be a voltage drop across the cables. The sense lines connected from the supply to the load compensate for these unwanted voltage drops since the voltage can be measured directly at the DUT.

Most Rohde&Schwarz power supplies are equipped with sense lines.

Protection functions

To safeguard the instrument and the DUT, Rohde&Schwarz power supplies provide a variety of protection functions.

Depending on the model, users can separately set the maximum current (electronic fuse, overcurrent protection, OCP), the maximum voltage (overvoltage protection, OVP) and the maximum power (overpower protection, OPP) for each channel. When such a limit is reached, the affected output channel will be switched off.

Overtemperature protection prevents the instrument from overheating.

Type	Designation	Page
R&S°NGE100B	Power supply series	27
R&S°NGA100	Power supply series	29
R&S°HMP	Power supply series	31
R&S°NGL200	Power supply series	33
R&S°NGM200	Power supply series	35
R&S°NGP800	Power supply series	37
R&S°NGU	Source measure units	39

Power supply portfolio



	Basic units R&S®NGE102B/103B	R&S®NGA101/102/141/142	Performance units R&S®HMP2020/2030	R&S®HMP4030/4040
Electrical specifications				
Number of output channels	2/3	1/2	2/3	3/4
Maximum output power	66 W/100 W	40 W/80 W/40 W/80 W	188 W	384 W
Maximum output power per channel	33.6 W	40 W	80 W, except R&S®HMP2020, CH1: 160 W	160 W
Output voltage per channel	0 V to 32 V	R&S®NGA101/102: 0 V to 35 V R&S®NGA141/142: 0 V to 100 V	0 V to 32 V	0 V to 32 V
Maximum output current per channel	3 A	R&S®NGA101/102: 6 A R&S®NGA141/142: 2 A	5 A, except R&S®HMP2020, CH1: 10 A	10 A
Voltage ripple and noise (RMS) (20 Hz to 20 MHz)	< 1.5 mV (typ.)	R&S®NGA101/102: < 0.5 mV (meas.); R&S®NGA141/142: < 1.5 mV (meas.)	< 1.5 mV (meas.)	< 1.5 mV (meas.)
Current ripple and noise (RMS) (meas.) (20 Hz to 20 MHz)	< 2 mA	< 500 µA	< 1 mA	< 1 mA
Load recovery time ¹⁾ (meas.)	< 200 µs	R&S®NGA101/102: < 100 µs; R&S®NGA141/142: < 50 µs	< 1 ms	< 1 ms
Programming/readback resolution				
Voltage	10 mV	1 mV	1 mV	1 mV
Current	1 mA	programming: 1 mA readback: 0.1 mA	< 1 A: 0.1 mA (10 A CH: 0.2 mA); ≥ 1 A: 1 mA	< 1 A: 0.2 mA; ≥ 1 A: 1 mA
Readback accuracy (± (% of output + offset))				
Voltage	< 0.1% + 20 mV	R&S®NGA101/102: 0.02% + 5 mV R&S®NGA141/142: 0.02% + 10 mV	< 0.05% + 5 mV	< 0.05% + 5 mV
Current	< 0.1% + 5 mA	< 0.03% + 500 µA	< 0.1% + 2 mA	< 0.1% + 2 mA
Special functions				
Measurement functions	voltage, current, power	voltage, current, power	voltage, current	voltage, current
Protection functions	OVP, OCP, OPP, OTP	OVP, OCP, OPP, OTP	OVP, OCP, OTP	OVP, OCP, OTP
FuseLink function	•	• (R&S®NGA102/142)	•	•
Fuse delay	•	•	•	•
Remote sensing	–	•	•	•
Sink mode	–	–	–	–
Output delay	–	–	–	–
Trigger input/output	o/o	o/o	–	–
Arbitrary function	• (CH1: EasyArb)	• (CH1: EasyArb)	• (EasyArb)	• (EasyArb)
Analog/modulation interface	–	–	–	–
Data logging	–	• (standard mode)	–	–
Display and interfaces				
Display	3.5" QVGA	3.5"/QVGA	240 × 64 pixel LCD	240 × 128 pixel LCD
Rear panel connections	–	8-pin connector block	4-pin connector block per channel	8-pin connector block per 2 channels
Remote control interfaces	standard: USB; optional: LAN	standard: USB, LAN	optional: USB, LAN, IEEE-488 (GPIB), RS-232	optional: USB, LAN, IEEE-488 (GPIB), RS-232
General data				
Dimensions (W × H × D)	222 × 97 × 310 mm	222 × 97 × 448 mm	285 × 93 × 405 mm	285 × 136 × 405 mm
Weight	4.9 kg/5.0 kg	6.6 kg/7.0 kg/6.9 kg/7.3 kg	7.8 kg/8.0 kg	12.4 kg/12.8 kg
Rack adapter	R&S®HZC95 option	R&S®HZN96 option	R&S®HZ42 option	R&S®HZZ91 option

All data valid at +23°C (–3°C/+7°C) after 30 minutes warm-up time.

• yes – no ○ optional

¹⁾ 10% to 90% load change within a band of ±20 mV of set voltage.

²⁾ In the most sensitive measurement range.



R&S®NGP802/822/804/814/824	Specialty units R&S®NGL201/NGL202	R&S®NGM201/202	R&S®NGU201/401
2/4	1/2	1/2	1
400 W/800 W	60 W/120 W	60 W/120 W	60 W
200 W	60 W	60 W	60 W
0 V to 32 V (32 V channels); 0 V to 64 V (64 V channels)	0 V to 20 V	0 V to 20 V	R&S®NGU201: 0 V to 20 V R&S®NGU401: -20 V to +20 V
20 A (32 V channels); 10 A (64 V channels)	≤ 6 V output voltage: 6 A; > 6 V output voltage: 3 A	≤ 6 V output voltage: 6 A; > 6 V output voltage: 3 A	≤ 6 V output voltage: 8 A; > 6 V output voltage: 3 A
< 3 mV (meas.)	< 500 μV (meas.)	< 500 μV (meas.)	< 500 μV (meas.)
< 3.5 mA	< 1 mA	< 1 mA	< 1 mA
< 400 μs	< 30 μs	< 30 μs	< 30 μs
1 mV	1 mV/10 μV	1 mV/5 μV ²⁾	50 μV/1 μV ³⁾
0.5 mA	0.1 mA/10 μA	0.1 mA/10 nA ³⁾	100 nA/100 pA ³⁾
< 0.05% + 5 mV (32 V channels); < 0.05% + 10 mV (64 V channels)	< 0.02% + 2 mV	< 0.02% + 500 μV ³⁾	< 0.02% + 500 μV ³⁾
< 0.1% + 20 mA (32 V channels); < 0.1% + 10 mA (64 V channels)	< 0.05% + 250 μA	< 0.05% + 15 μA ³⁾	< 0.025% + 15 nA ³⁾
voltage, current, power, energy OVP, OCP, OPP, OTP	voltage, current, power, energy OVP, OCP, OPP, OTP	voltage, current, power, energy OVP, OCP, OPP, OTP	voltage, current, power, energy OVP, OCP, OPP, OTP
•	• (R&S®NGL202)	• (R&S®NGM202)	–
•	•	•	•
•	•	•	•
–	•	•	•
•	• (R&S®NGL202)	• (R&S®NGM202)	–
o/o	o/o	o/o	o/o
• (QuickArb)	• (QuickArb)	• (QuickArb)	• (QuickArb)
o/–	–	–	R&S®NGU401: modulation interface
• (standard mode)	• (standard mode)	• (standard and fast mode)	• (standard and fast mode)
TFT 5" 800 × 480 pixel WVGA touch	TFT 5" 800 × 480 pixel WVGA touch	TFT 5" 800 × 480 pixel WVGA touch	TFT 5" 800 × 480 pixel WVGA touch
8-pin connector block per 2 channels	8-pin connector block per channel	8-pin connector block per channel	8-pin connector block
standard: USB, LAN; optional: IEEE-488 (GPIB)	standard: USB, LAN; optional: IEEE-488 (GPIB)	standard: USB, LAN; optional: IEEE-488 (GPIB)	standard: USB, LAN; optional: IEEE-488 (GPIB)
362 × 100 × 451 mm	222 × 97 × 436 mm	222 × 97 × 436 mm	222 × 97 × 436 mm
7.5 kg/8.0 kg	7.1 kg/7.3 kg	7.2 kg/7.4 kg	7.1 kg
R&S®ZZA-GE23 option	R&S®HZN96 option	R&S®HZN96 option	R&S®HZN96 option

Power supplies

R&S®NGE100B Power Supply Series



Meets your daily needs

What sets these power supplies apart from others in their class?

- ▶ All channels are galvanically isolated and earth-free
- ▶ All channels are electrically equivalent with the same voltage, current and power
- ▶ Parallel and serial operation
- ▶ Protection functions to safeguard instrument and DUT
- ▶ Tracking and link functions
- ▶ Remote control via USB interface and optional LAN

Model overview

Model	Channel count	Max. voltage	Max. current	Max. power	Resolution
R&S®NGE102B	2	2 × 32 V	2 × 3 A	66 W	10 mV/1 mA
R&S®NGE103B	3	3 × 32 V	3 × 3 A	100 W	10 mV/1 mA

Important facts

Specification	R&S®NGE100	Why this is important
Interface options	USB, LAN (optional) Wi-Fi (optional)	Modern and common interface capabilities allow quick and ready access to control and program the instrument.
Dimensions	½ 19" 2 HU	A small footprint for the power supply allows placement in tight lab space conditions or university settings as well as high-density manufacturing and rack applications.
Arbitrary function generation	EasyArb	Easily programmable time/voltage or time/current curves.

Scope of delivery

- ▶ Power cable
- ▶ Quick start guide
- ▶ 3 year warranty

Recommended options/accessories

Description	Type
Base unit	
Two-channel power supply	R&S®NGE102B
Three-channel power supply	R&S®NGE103B
Software options	
Ethernet remote control	R&S®NGE-K101
Digital I/O trigger	R&S®NGE-K103
System components	
19" rack adapter, 2 HU	R&S®HZC95



The perfect choice for:	
Education	R&D
Maintenance and repair	Manufacturing test

Your benefit	Features
Straightforward operation	All basic functions can be operated via direct keys on the front panel. The rotary knob can be used to adjust the desired voltage and current
The separate output channels can work like individual power supplies	All channels are electrically equivalent, galvanically isolated, earth-free and can be combined in serial or in parallel to achieve higher voltages or currents
Small, compact and quiet	Combination of primary transformer, secondary switching regulator and additional linear control reduces weight and size while maintaining robustness and low ripple

Power supplies

EasyArb

EasyArb Mode on Ch 1 **Enabled**

EasyArb Repetition **1**

Number of Data Points **4**

#	Voltage	Current	Duration
1	5.00 V	0.900 A	1.00 s
2	10.00 V	0.700 A	5.00 s
3	3.00 V	1.000 A	0.03 s
4	10.00 V	0.800 A	60.00 s

Apply EasyArb Data **Apply**

Clear Data Points **Clear**

Comfort features for special applications: EasyArb allows the user to program time/voltage or time/current sequences

EasyRamp

Ch 1 Ch 2 Ch 3

Output Ramping

Enabled **Enabled** **Disabled**

Ramping Time

10 ms 300 ms 10 ms

Comfort features for special applications: EasyRamp simulates operating conditions with controlled rise of supply voltage to prevent a sudden voltage surge

Parallel and serial operation

Running in parallel, higher currents can be achieved; serial connected channels yield higher voltages.

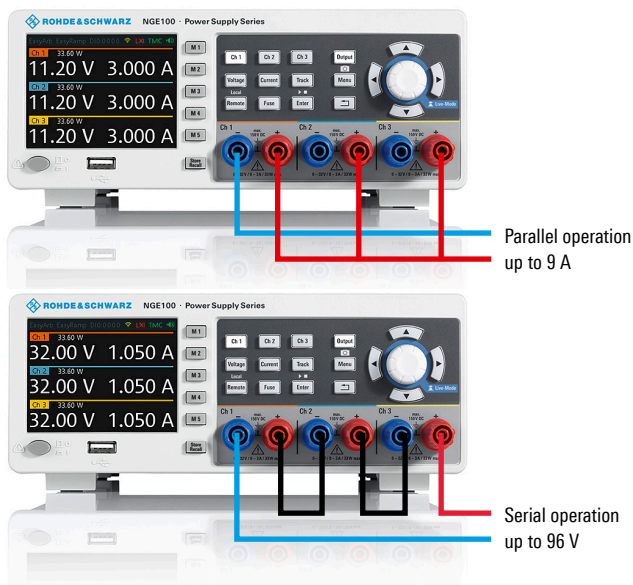

Fuse

Ch 1 Ch 2 Ch 3

Fuse Delay

10 ms 20 ms 30 ms

Fuse Linking

Ch 2 **Disabled** Ch 1 & 2

Users can set the power supply so that all channels are switched off if one channel hits the limit; or it can be set to leave one channel working

R&S®NGA100 Power Supply Series



Linear. Accurate. Affordable.

The R&S®NGA100 power supplies are linear, compact and easy to use. All models have excellent readback accuracy with a low-current range for demanding measurements.

Features such as data logging, arbitrary waveforms, built-in statistics and remote sensing make the instruments ideal for various bench applications. Equipped with a number of different remote interfaces, including USB and Ethernet, the R&S®NGA100 power supplies are also great for automated tests. Advanced protective functions keep devices connected and power supplies safe.

Model overview

Model	Channels	Max. output power	Max. voltage	Max. current	Ripple and noise (20 Hz to 20 MHz)	Readback accuracy
R&S®NGA101	1	40 W	35 V	6 A	< 0.5 mV (RMS), < 500 µA (RMS)	< 0.02% + 5 mV, < 0.03% + 500 µA
R&S®NGA102	2	80 W	70 V (serial)	12 A (parallel)	< 1.5 mV (RMS), < 500 µA (RMS)	< 0.02% + 10 mV, < 0.03% + 500 µA
R&S®NGA141	1	40 W	100 V	2 A	< 0.5 mV (RMS), < 500 µA (RMS)	< 0.02% + 5 mV, < 0.03% + 500 µA
R&S®NGA142	2	80 W	200 V (serial)	4 A (parallel)	< 1.5 mV (RMS), < 500 µA (RMS)	< 0.02% + 10 mV, < 0.03% + 500 µA

Important facts

Specification	R&S®NGA100	Why this is important
Readback accuracy	<ul style="list-style-type: none"> ▶ voltage <ul style="list-style-type: none"> - R&S®NGA101, R&S®NGA102: < 0.02% + 5 mV - R&S®NGA141, R&S®NGA142: < 0.02% + 10 mV ▶ current: < 0.03% + 500 µA 	The R&S®NGA100 can accurately measure and replicate the actual power consumption for a device, even at low voltage and current levels. This simplifies the setup by reducing the need for external multimeters.
Ripple and noise (20 Hz to 20 MHz)	<ul style="list-style-type: none"> ▶ voltage <ul style="list-style-type: none"> - R&S®NGA101, R&S®NGA102: < 0.5 mV (RMS) - R&S®NGA141, R&S®NGA142: < 1.5 mV (RMS) ▶ current: < 500 µA (RMS) 	Allows the supply of interference-free voltage to sensitive DUTs with advanced electronic circuitry that is often sensitive to interference on supply lines.
Max. output power	80 W	Increased output power enables the driving of DUTs with greater power consumption.

Scope of delivery

- ▶ Power cable
- ▶ Quick start guide
- ▶ 3 year warranty

Recommended options/accessories









Description	Type
Software options	
Digital trigger I/O	R&S®NGA-K103
System components	
19" rack adapter, 2 HU	R&S®HZN96

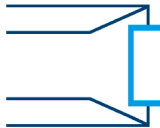

The perfect choice for:	
R&D	Manufacturing
IoT and low-power designs	General purpose and education

Your benefit	Features
Linear design	The linear design of the output stages allows R&S®NGA100 power supplies to operate with minimal residual ripple and noise for extremely stable output voltage and current.
FlexPower	The R&S®NGA100 power supplies operate with maximum power at various operating points and cover far more applications than single-range power supplies.
Channel fusion	Activate channel fusion in either serial or parallel mode and the device will act like a single-channel version of itself with double voltage or current capabilities.
Low-current measurement range	IoT devices can have multiple sleep modes with very low current consumption. To accurately determine these operating states, R&S®NGA100 power supplies have a low-current measurement range.

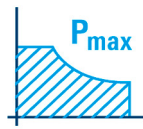
Features

 EasyRamp	 Channel fusion	 EasyArb	 Remote sensing	 Built-in measurements
 Data logging	 Save/recall device settings	 FlexPower	 Digital trigger I/O	 High accuracy

R&S®NGA101/R&S®NGA102 FlexPower curve per output

The R&S®NGA100 series operates with maximum power at various operating points and covers far more applications than single-range power supplies.

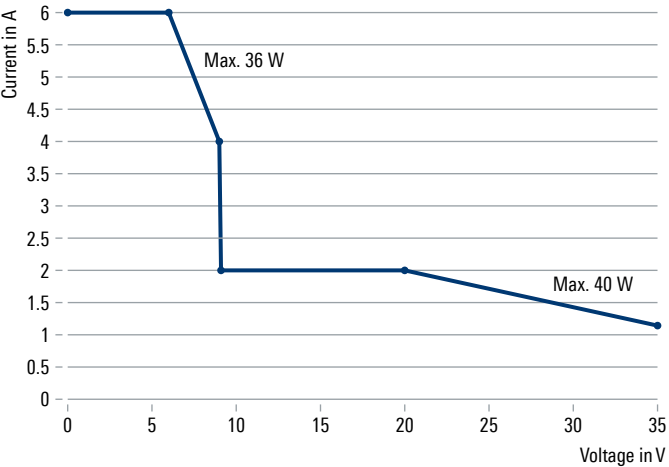

Channel fusion

Activate channel fusion in either serial or parallel mode and the device will act like a single-channel version of itself. In serial mode, the outputs are connected internally, while the parallel mode requires external wiring.

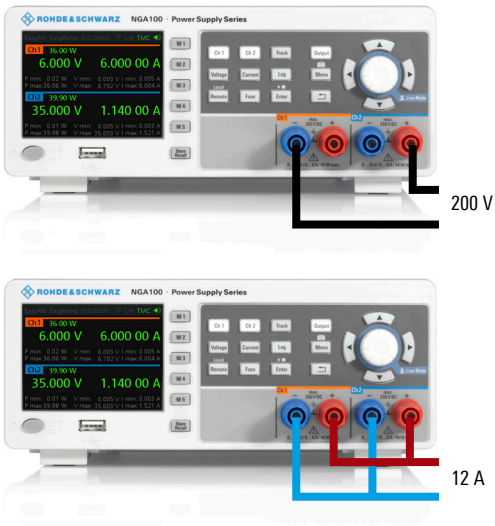

R&S®HMP Power Supply Series



Up to four channels in a single instrument

The R&S®HMP power supplies are primarily designed for industrial use – for production environments as well as for development labs. These rugged instruments offer high efficiency with low residual ripple and many protection functions.

- ▶ Four models: 2 or 3 channels with 188 W total output power, 3 or 4 channels with 384 W total output power
- ▶ Galvanically isolated, floating outputs with overload and short-circuit protection
- ▶ Remote sensing eliminates voltage drops on the load leads
- ▶ Comfortable programming features and 19" rack adapters ensure perfect integration into production environments

Model overview

Model	No. of channels	Output voltage per channel	Output current per channel	Total output power	Max. output power per channel	Max. voltage in serial operation	Max. current in parallel operation
R&S®HMP2020	2		channel 1: 0 A to 10 A channel 2: 0 A to 5 A	188 W	channel 1: 160 W channel 2: 80 W	64 V	15 A
R&S®HMP2030	3	0 V to 32 V	0 A to 5 A	188 W	80 W	96 V	15 A
R&S®HMP4030	3		0 A to 10 A	384 W	160 W	96 V	30 A
R&S®HMP4040	4		0 A to 10 A	384 W	160 W	128 V	40 A

Important facts

Specification	R&S®HMP2020/2030; R&S®HMP4030/4040	Why this is important
Number of output channels	2/3; 3/4	More channels in a compact package provide more flexibility for any specific application, especially with equal channels.
Total output power	max. 188 W; max. 384 W	With more output power, DUTs with more power consumption can be driven.
Max. output power per channel	80 W (R&S®HMP2020: 160 W); 160 W	Same output power on all channels provides more flexible configuration in specific applications.
Max. output voltage	32 V (all channels); 32 V (all channels)	With the same output voltage on each channel, there are no limitations for using channels in different applications.
Max. current per channel	5 A (R&S®HMP2020: 10 A); 10 A	With the same output current on each channel, there are no limitations for using channels in different applications.
Sense function	yes, for each channel	Sense function provides more accurate voltage at the DUT especially when high current is needed.
Dimensions (W × H × D)	285 mm × 95 mm × 405 mm; 285 mm × 136 mm × 405 mm	The size of the instrument determines how much space is left on the workbench for the measurement setup.
Weight	7.8 kg/8.0 kg; 12.4 kg/12.8 kg	If the instrument has to be used in different places, it is better to have a lighter instrument.

Scope of delivery

- ▶ Quick start guide
- ▶ Set of power cables
- ▶ 3 year warranty

Recommended options/accessories

Description	Type
Interfaces and system components	
Dual interfaces (RS-232/USB)	R&S®HO720, R&S®HO732
IEEE-488 (GPIB) interface	R&S®HO740
19" rack adapter, 2 HU, for R&S®HMP2020/HMP2030	R&S®HZ42
19" rack adapter, 4 HU, for R&S®HMP4030/HMP4040	R&S®HZZP91



The perfect choice for:	
Engineering lab	Production testing
Maintenance and repair	General purpose

Your benefit	Features
Up to 4 channels in a single compact box	Flexible configuration for any specific application, including sense lines for each channel to compensate voltage drops over the supply leads
Channels galvanically isolated and floating	Serial operation with up to 128 V or parallel operation with up to 40 A
Overcurrent protection (electronic fuse) and overvoltage protection	To safeguard the instrument and the DUT. The fuse link technology switches off all selected channels when one of them reaches its current limit
Easily programmable time/voltage or time/current curves	To vary voltage or current during a test sequence; can be programmed manually via the user interface or via the external interfaces

Power supplies



Connections for all channels – including sense lines – are also provided on the rear panel (shown here: R&S®HMP4000)

All channels galvanically isolated and floating

The R&S®HMP power supply family consists of instruments with two, three or four channels. The circuitry of each channel is completely isolated from the others; there is no connection to chassis ground. This makes it easy to combine the channels to drive balanced circuitries that might need +12 V/–12 V, for example, and avoids any ground problems in complex DUTs.

Supplying balanced circuits

Two channels can be connected together to supply balanced circuits with e.g. +12 V/–12 V.

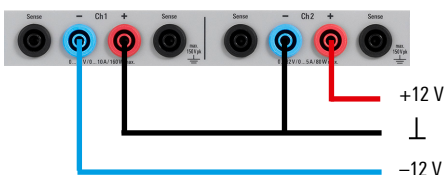

Intuitive to use

All basic R&S®HMP power supply functions can be operated directly via keys on the front panel. It is only necessary to use the menu level for special functions that are needed less frequently.

Color coding of operating states

All settings and operating conditions, including the output power and the status of the protection functions, are shown on the display and indicated by the colors of the illuminated channel keys. The colors of the illuminated keys indicate the different operating conditions:

- ▶ Active channel in constant voltage mode: green
- ▶ Active channel in constant current mode: red
- ▶ Channel in setting mode: blue

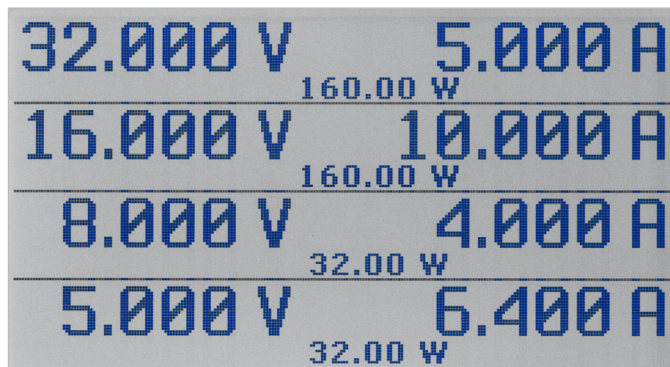

All settings and operating states are clearly visualized. Constant voltage mode is indicated by a green key, constant current mode is indicated by a red key. The key color changes to blue in setting mode.

R&S®NGL200 Power Supply Series



What sets these power supplies apart from others?

- ▶ Fast regulation of output voltage with minimum overshoot and very fast load recovery time
- ▶ Minimum residual ripple and noise to supply interference-free voltage to sensitive DUTs
- ▶ Readings with up to 6½ digit resolution are perfect for characterizing devices that have low power consumption in standby mode and high current in full load operation
- ▶ Two quadrants: operates as source or sink

Model overview

Model	Number of channels	Max. output power	Output power per channel	Output voltage per channel	Output current per channel	Load recovery time	Resolution
R&S®NGL201	1	60 W	max. 60 W	0 V to 20 V	▶ ≤ 6 V: 6 A ▶ > 6 V: 3 A	< 30 μs	1 mV/0.1 mA
R&S®NGL202	2	120 W					

Important facts

Specification	R&S®NGL200	Why this is important
Large high-resolution touchscreen	TFT 5" 800 × 480 pixels WVGA touch	Easy operation and display of a wide variety of additional information such as power values and statistics.
Various protection and safety functions	OVP, OCP, OPP, OTP, adjustable limits	Protect your DUT and the power supply.
Sense function for lead resistance compensation	▶ R&S®NGL201: front and rear panels ▶ R&S®NGL202: rear panel	Regulate the voltage directly at the load, compensating for voltage drops over the supply leads.
QuickArb	▶ dwell time: 1 ms to 10 s ▶ maximum number of points: 4096	Simulate different battery charging conditions or program very short voltage drops to test the power-up behavior of a DUT.
Remote control via various interfaces	USB, Ethernet, WLAN (optional), IEEE-488 (optional)	Key for integration into test systems and automated operation via scripts.
Fast command processing time	typ. < 6 ms	Complex measurement sequences require ever faster setting, measuring and command processing times.

Scope of delivery

- ▶ Power cord
- ▶ Quick start guide
- ▶ 3 year warranty

Recommended options/accessories

Description	Type
IEEE-488 (GPIB) interface	R&S®NGL-B105
Wireless LAN remote control	R&S®NGL-K102
Digital I/O trigger	R&S®NGE-K103
19" rack adapter, 2 HU	R&S®HZN96

Optimized load recovery time

Power supplies usually respond to abrupt load changes with overshoot and slow recovery times. Thanks to specially optimized control circuits, the R&S®NGL200 series achieves recovery times of < 30 μs with minimal overshoot, making them perfect for supplying sensitive components.

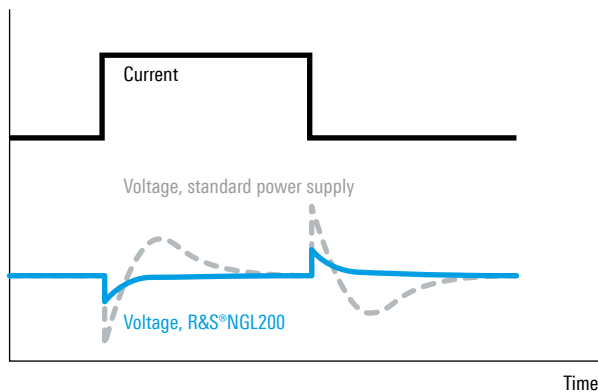

The perfect choice for:	
Battery tests	Power consumption tests
Simulation of voltage drops	Supplying sensitive designs

Overvoltage protection (OVP), overpower protection (OPP)

If the voltage/power exceeds the configured maximum value, the channel is switched off and the corresponding symbol flashes on the display.

Overcurrent protection (electronic fuse, OCP)

The channels of R&S®NGL200 power supplies provide electronic fuses that can be set individually. If the channel current exceeds the set current, the channel is automatically switched off and a message is displayed.

QuickArb function

The Arb function lets you configure time/voltage or time/current sequences. With up to 4096 points and a dwell time resolution of up to 1 ms, the QuickArb function sets new standards.

Easy Ramp function

The output voltage can be increased continuously within a time frame of 10 ms to 10 s to avoid an abrupt rise of the supply voltage as is sometimes required by sensitive applications.

Your benefit	Features
Optimized load recovery time with minimal overshoot	Due to the optimized load recovery time of < 30 μs with minimal overshoot during challenging load conditions, the R&S®NGL200 is perfect when testing IoT and other battery-powered devices which require very little current in sleep mode and abruptly increase current when switching to transmit mode.
Low ripple and noise	To supply interference-free voltage to sensitive designs such as complex semiconductors and to support the development of power amplifiers and MMICs.
Sink and source operation	The linear two-quadrant output amplifier design of the R&S®NGL200 enables sink and source operation to simulate batteries and loads.
6½ digit resolution	With up to 6½ digit resolution when measuring voltage, current and power, the R&S®NGL200 is optimal for characterization of devices with low standby power consumption and high current in full load operation. It can replace an additional DMM in many applications.



Easy operation: The high-resolution capacitive touchscreen is the central operating element for R&S®NGL200 power supplies. Icons clearly show the status of the set protection levels or special functions. Active channels in constant voltage mode light up green, while red is used for constant current mode. When the channels are switched on, the key lights up blue (active).



Readings with up to 6½ digit resolution: With a resolution of up to 6½ digits when measuring voltage, current and power, the R&S®NGL200 power supplies are perfect for measurements on devices that have low power consumption in standby mode and high current in full load operation. The large high-resolution display provides a lot of additional information such as power values and statistics.

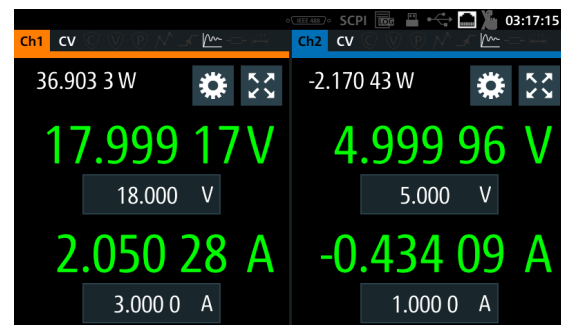

Two-quadrant operation, minimum ripple and noise: The architecture of the R&S®NGL200 power supplies allows them to function both as a source and a sink. The power automatically switches from sink and source mode. In this example, channel 2 is operating as a load. The linear design of the output stages reduces residual ripple and noise to a minimum and makes the R&S®NGL200 the perfect tool to support the development of power amplifiers and MMICs.

R&S®NGM200 Power Supply Series



High-speed accuracy

What sets these power supplies apart from others in their class?

- ▶ All channels are galvanically isolated and earth-free
- ▶ All channels are electrically equivalent with the same voltage, current and power
- ▶ Parallel and serial operation
- ▶ Protection functions to safeguard instrument and DUT
- ▶ Tracking and link functions
- ▶ Remote control via USB interface and optional LAN or wireless LAN, unique in this class

Model overview

Model	Channel count	Max. output power	Output power per channel	Output voltage per channel	Output current per channel	Load recovery time	Max. readback resolution
R&S®NGM201	1	60 W	max. 60 W	0 V to 20 V	≤ 6 V: 6 A; > 6 V: 3 A	< 30 μs	1 μV/10 nA
R&S®NGM202	2	120 W	3 × 3 A				

Important facts

Specification	R&S®NGM200	Why this is important
Number of channels	1/2	More channels provide more flexibility for any specific application.
Max. output power per channel	60 W	With more output power, DUTs with more power consumption can be driven.
Voltage ripple and noise (20 Hz to 20 MHz)	< 500 μV (RMS), < 2 mV (peak-to-peak)	Allows the instrument to supply interference-free voltage to sensitive DUTs with advanced electronic circuitry that is often sensitive to interference on the supply lines.
Load recovery time (20 mV)	< 30 μs	Important to supply DUTs when switching from low power consumption in standby mode to high current in full load operation without creating voltage drops or overshoots.
Max. measurement speed	500 000 sample/s (2 μs)	High-speed acquisition, allows detection of spikes in the microsecond range that cannot be detected with slower instruments.
Protection functions	OCP/OVP/OPP/OTP	These functions safeguard the instrument and the device under test from damage.

Scope of delivery

- ▶ Power cable
- ▶ Quick start guide
- ▶ 3 year warranty

Recommended options/accessories

Description	Type
Hardware option	
IEEE-488 (GPIB) interface	R&S®NGM-B105
Software options	
Digital I/O trigger	R&S®NGM-K103
Digital voltmeter functionality	R&S®NGM-K104
Battery simulation	R&S®NGM-K106
System components	
19" rack adapter, 2 HU	R&S®HZN96

Optimized load recovery time

Under challenging load conditions, most power supplies respond with slow recovery times and overshoots. Specially developed circuits in the R&S®NGM200 power supplies achieve a load recovery time of < 30 μs with minimal overshoot, making them perfect for supplying sensitive components.

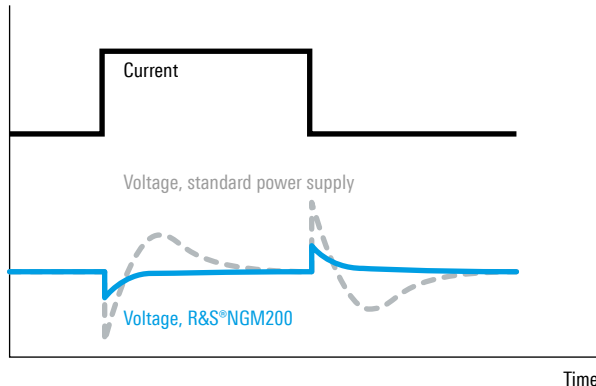

The perfect choice for:	
Battery tests	Power consumption tests
Simulation of voltage drops	Supplying sensitive designs

Your benefit	Features
Minimal overshoot from abrupt load changes	<ul style="list-style-type: none"> ▶ Optimized load recovery time < 30 μs ▶ Handles abrupt load changes from a few μA to the ampere range without creating voltage drops or overshoots
Supply interference-free voltage to sensitive designs	<p>Low ripple and noise values allow you to supply interference-free voltage to sensitive designs such as complex semiconductors and to support the development of power amplifiers and MMICs</p> <ul style="list-style-type: none"> ▶ Acquisition rate: up to 500 ksample/s ▶ Voltage and current results available every 2 μs ▶ On the two-channel R&S®NGM202, data acquisition on both channels in parallel
Capture fast variations in voltage/current	<ul style="list-style-type: none"> ▶ Simulate the actual battery output performance ▶ Testing can be based on a selected battery model ▶ Battery capacity, state of charge (SoC) and open circuit voltage (Voc) can be set to any state to test the device under specific circumstances
Realistic battery simulation	

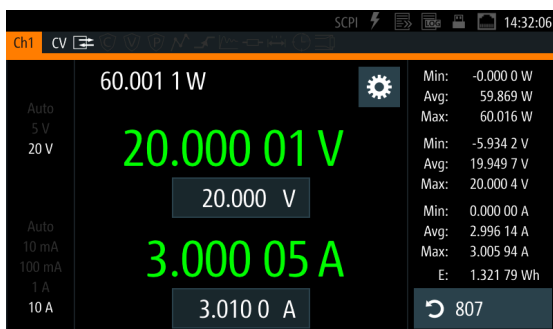

Readings with up to 6 ½ digit resolution: With a resolution of up to 6 ½ digits when measuring voltage, current and power, the R&S®NGM200 power supplies are perfect for characterizing devices that have low power consumption in standby mode and high current in full load operation. Two voltage measurement ranges and four current measurement ranges provide high accuracy and resolutions down to 1 μV/10 nA.

The high-resolution display provides additional information such as power values and statistics.



Two-quadrant operation, minimum ripple and noise: The architecture of the R&S®NGM200 power supplies allows them to function both as a source and a sink. The instruments automatically switch between sink and source operation. In this example, channel 2 works as a load. The linear design of the output stages reduces residual ripple and noise to a minimum and makes them perfect for the development of power amplifiers and MMICs.

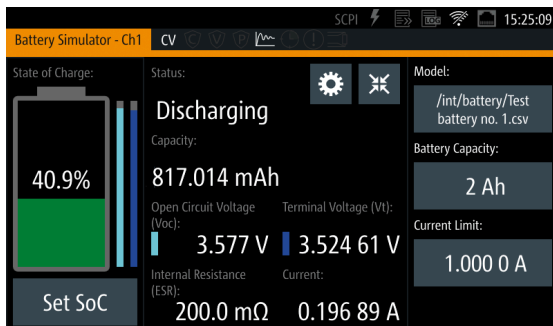

Battery simulation: When battery-operated devices have to be optimized for lifecycle, the discharging behavior of the battery type needs to be considered. The battery simulator function makes it possible to simulate the real battery output performance. Testing can be based on a selected battery model, and battery capacity, SoC and Voc can be set to any state to test the device under specific circumstances. The charging behavior of a battery can also be simulated, for example when designing battery chargers. In this application, the R&S®NGM200 is used in sink mode.

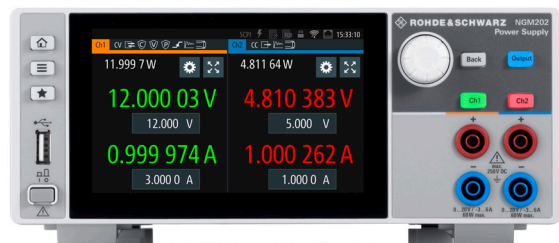

Easy operation: The high-resolution capacitive touchscreen is the central operating element for the R&S®NGM200 power supplies. Icons clearly show the status of set protection levels or special functions. When the power supply is in constant voltage mode, the numbers and the keys light up green. Red is used for constant current mode. The Output button lights up blue to indicate that channels are switched on (active).

R&S®NGP800 Power Supply Series



Boost your efficiency with quad-core power

The R&S®NGP800 DC power supply series, comprising five models with 400 W or 800 W, provides maximum power at a variety of operating points. The two or four 200 W outputs can each supply up to 64 V or up to 20 A. Electrically equivalent and galvanically isolated outputs can be wired in series or parallel for up to 250 V or 80 A.

All R&S®NGP800 power supplies include remote sense terminals, USB and a LAN interface. A user-installable GPIB interface, a digital trigger I/O, an analog input and a wireless LAN interface are optional, making these instruments great on the bench in automated test systems.

Model overview

Model	Channel count	Total output power	Readback resolution	Voltage per channel	Output current per channel	Output power per channel
R&S®NGP802	2	400 W	▶ voltage: 1 mV ▶ current: 0.5 mA	0 V to 32 V	20 A	200 W
R&S®NGP804	2	400 W		0 V to 32 V	20 A	200 W
R&S®NGP814	4	800 W		▶ CH1, CH2: 0 V to 32 V ▶ CH3, CH4: 0 V to 64 V	▶ CH1, CH2: 20 A ▶ CH3, CH4: 10 A	200 W
R&S®NGP822	2	400 W		0 V to 64 V	10 A	200 W
R&S®NGP824	4	800 W		0 V to 64 V	10 A	200 W

Important facts

Specification	R&S®NGP800	Why this is important
Max. output power	400 W/800 W	For power hungry devices.
Number of outputs	2/4	Powers up to 4 DUTs simultaneously.
Max. voltage per output	32 V/64 V	Covers 48 V applications.
Max. current per output	20 A/10 A	Meets high current consumption requirements.
Max. power per output	200 W	Gets the full 200 W on each output (no shared total power among channels).
Programming resolution	1 mV/0.5 mA	Accurately sets your supply voltage and current.
Readback resolution	1 mV/0.5 mA	Replaces a DMM in many applications.
Acquisition rate	125 sample/s	Great for in-depth post analysis.
Display	5" 800 × 480 pixel touch	Enter values much faster with intuitive touch display.

Scope of delivery

- ▶ Power cable
- ▶ Terminal blocks
- ▶ Quick start guide
- ▶ 3 year warranty

Recommended options/accessories

Description	Type
Hardware option	
IEEE-488 (GPIB) interface	R&S®NG-B105
Software options	
Digital I/O trigger	R&S®NGP-K103
Analog input	R&S®NGP-K107
System components	
19" rack adapter, 2 HU	R&S®ZZA-GE23



The perfect choice for:	
R&D	Manufacturing
Automotive	General purpose

Your benefit	Features
Power four DUTs simultaneously	<ul style="list-style-type: none"> ▶ Up to four independent, floating outputs ▶ All outputs galvanically isolated ▶ Space, cost and time efficient
Maximum power at various operating points	<ul style="list-style-type: none"> ▶ FlexPower ▶ Up to 80 A when connected in parallel ▶ Up to 250 V when connected in series
All you need at a glance	<ul style="list-style-type: none"> ▶ Large high-resolution touchscreen ▶ Built-in measurements ▶ Detailed statistics

Power supplies

More functions



EasyRamp



Output delay



QuickArb

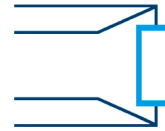

Remote sensing



Built-in measurements



Data logging



Save/recall device settings



User adjustment



Digital trigger I/O

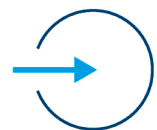

Analog input



Large high-resolution touchscreen: The home screen gives you a clear overview of all your channels. Each channel can be selected for a more detailed view with a wide variety of additional information such as statistics and icons indicating the status of set protection levels or special functions.

Parallel and serial operation

In case your application requires more voltage or current, connect the outputs in series or parallel and get up to 250 V (R&S®NGP824) or 80 A (R&S®NGP804). Using the tracking function, voltage and current are adjusted on all selected channels simultaneously.

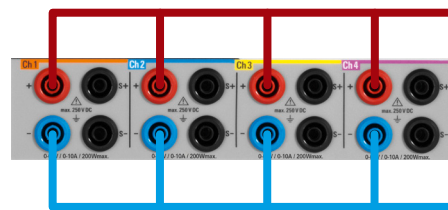

Parallel operation:
max. 80 A



Serial operation:
max. 250 V

R&S®NGU Source Measure Units



What sets this source measure unit apart?

- ▶ Two or four quadrants: source or sink operation with arbitrary polarity
- ▶ Minimum residual ripple and noise for interference-free voltage to sensitive DUTs
- ▶ Fast regulation of output voltage with minimum overshoot and very fast load recovery time
- ▶ Acquisition rate of up to 500 ksample/s to capture extremely fast voltage or current variations
- ▶ Voltage priority and current priority modes
- ▶ High-capacitance mode
- ▶ Modulation input (R&S®NGU401)

Model overview

Model	Output voltage	Max. output/sink power	Max. output/sink current	Load recovery time	Max. acquisition rate	Ripple and noise
R&S®NGU201	0 V to 20 V	60 W	≤ 6 V: 8 A;	< 30 μs	500 ksample/s	< 500 μV (RMS); < 1 mA (RMS) (meas.)
R&S®NGU401	-20 V to +20 V		> 6 V: 3 A			

Important facts

Specification	R&S®NGU	Why this is important
Quadrants	2/4	The source measure unit can function both as a source and a sink and simulate batteries or loads with two-quadrant architecture. Four-quadrant architecture units can source and sink in both polarities. This enables measuring the forward and reverse characteristics of semiconductor devices in a single test operation without changing the circuit.
Voltage ripple and noise (20 Hz to 20 MHz)	< 500 μV (RMS), < 2 mV (peak-to-peak)	The instrument can supply interference-free voltage to sensitive DUTs with advanced electronic circuitry which are often sensitive to interference on the supply lines.
Load recovery time (20 mV)	< 30 μs	Important for supplying DUTs when switching from low power consumption in standby to high current in full load operation without creating voltage drops or overshoots.
Max. measurement speed	500 000 sample/s (2 μs)	High-speed acquisition allows detection of spikes in the micro-second range that cannot be detected with slower instruments.
Protection functions	OCP/OVP/OPP/OTP	These functions safeguard the instrument and the device under test.

Scope of delivery

- ▶ Power cable
- ▶ Quick start guide
- ▶ 3 year warranty

Recommended options/accessories

Description	Type
Options	
Digital trigger I/O	R&S®NGU-K103
Digital voltmeter function	R&S®NGU-K104
IEEE-488 (GPIB) interface	R&S®NGU-B105
Battery simulation	R&S®NGU-K106
System components	
19" rack adapter, 2 HU	R&S®HZN96



The perfect choice for:	
High-precision source and sink measurements	Material and component tests
Supplying bipolar voltages	Simulation of voltage drops
Battery tests	Power consumption tests

Your benefit	Features
Minimal overshoot from abrupt load changes	<ul style="list-style-type: none"> ▶ Optimized load recovery time of < 30 μs ▶ Handles abrupt load changes from a few nA to the ampere range without creating voltage drops or overshoots
Analyze fast variations in voltage/current	<ul style="list-style-type: none"> ▶ Acquisition rate of up to 500 ksample/s ▶ Voltage and current results available every 2 μs
Supply positive and negative voltages and currents	<ul style="list-style-type: none"> ▶ Four-quadrant operation allows the R&S®NGU401 to act as a source or sink in both polarities ▶ Enables tasks such as measuring the forward and reverse characteristics of semiconductor devices in a single test operation without changes to the circuit
Can act as an AC source	<ul style="list-style-type: none"> ▶ The R&S®NGU401 source measure unit provides a modulation input to connect an arbitrary generator. The output follows the modulation input signal, the instrument acts as an AC source and simulates glitches and unstable conditions

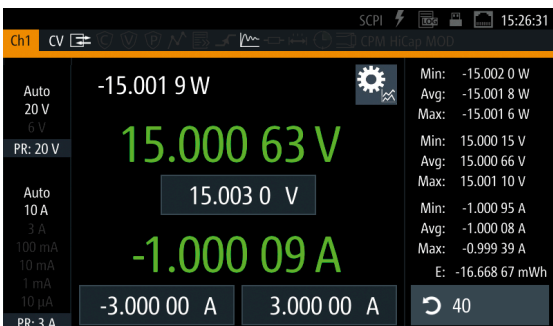

Two quadrants: operates as source and sink: The two-quadrant architecture of this source measure unit can function both as a source and a sink and simulate batteries and loads. The source measure unit automatically switches from source mode to sink mode. As soon as the externally applied voltage exceeds the set nominal voltage, current flows into the instrument, as indicated by a negative current reading. The linear design of the output stages reduces residual ripple and noise to a minimum.

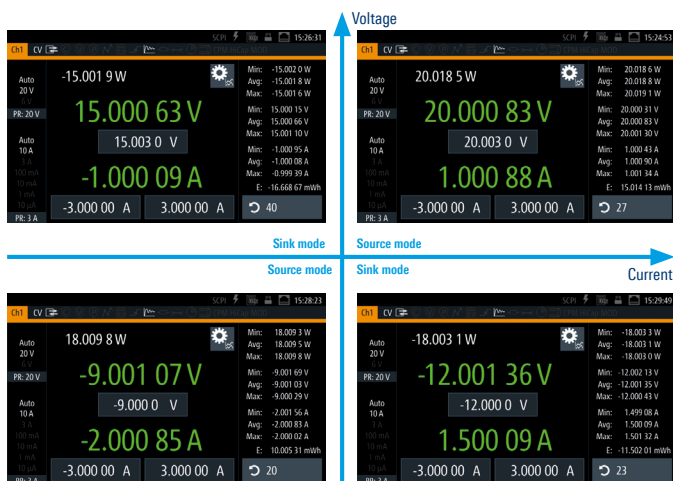

Four quadrants: source or sink operation with arbitrary polarity: The R&S®NGU401 can supply positive and negative voltages and currents with its four-quadrant architecture and can act as a source or sink in both polarities.

Optimized load recovery time

Under challenging load conditions, most power supplies respond with slow recovery times and overshoots. Specially developed circuits in the R&S®NGU source measure units achieve a load recovery time of < 30 μs with minimal overshoot, making them perfect for supplying sensitive components.

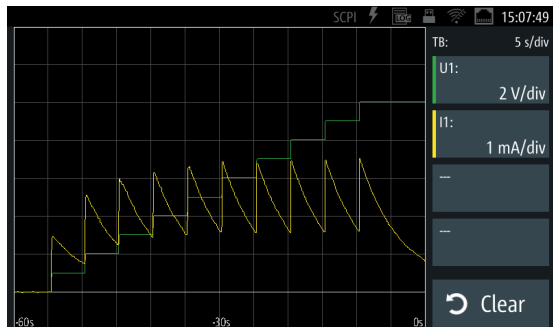
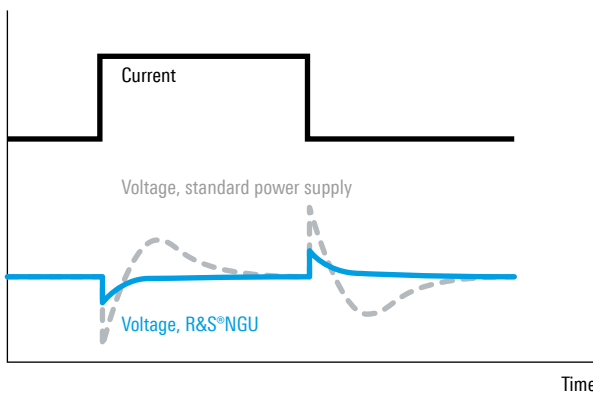

High-resolution graphical display of data: Here, the charging current of a capacitor is displayed while the voltage is increased stepwise. Up to four measurement functions can be selected and plotted against time, while minimum and maximum values can also be marked.

SIGNAL GENERATORS

Frequency range

The frequency range is the most important specification when selecting a suitable signal generator. The generator's upper and lower frequency limits must cover the needs of the application.

Output power

Output power is another key specification for selecting a signal generator. The higher the available power, the more likely you will be able to compensate for losses in the setup caused by cabling and components.

Instruments equipped with an electronic step attenuator provide very accurate low power levels and are not subject to the wear and tear of conventional mechanical attenuators.

Spectral purity

There are several measurements for assessing the spectral purity of a signal generator, including phase noise, spurious, harmonics and subharmonics. Phase noise measures the jitter of a signal. The better the spectral purity of a signal generator, the less it influences DUT measurements.

CW or modulated

Continuous wave (CW) generators provide only an unmodulated carrier frequency whereas analog signal generators can modulate the carrier frequency with e.g. AM, FM, ϕ M and pulse modulation.

Type	Designation	Page
R&S®HMF25xx	Arbitrary function generator	43
R&S®SMCV100B	Vector signal generator	45

Signal generator portfolio



Vector signal generators R&S®SMCV100B	
Description	Vector RF source
Performance	●●●●
Main features	<ul style="list-style-type: none"> ▶ good RF performance ▶ high output power ▶ RF DAC design
Frequency range	4 kHz to 3/6/7.125 GHz
I/Q modulation bandwidth	up to 240 MHz (internal)
Peak envelope power (PEP) (at 1 GHz/10 GHz)	+20 dBm/n.a.
SSB phase noise (at 1 GHz, 1 Hz measurement bandwidth, 20 kHz offset)	< -125 dBc
Harmonics (at 1 GHz)	< -30 dBc (level ≤ +13 dBm)
Nonharmonics (at 1 GHz, > 10 kHz offset from carrier)	< -52 dBc, -60 dBc (typ.) (level > +10 dBm)
Dimensions (W × H × D)	222 × 97 × 366 mm (87.4 × 38.2 × 144.1 in)

All values are specified, if not otherwise stated.

WinIQSIM2 Generator supports output of digital I/Q signals generated with R&S®WinIQSIM2 simulation software.

- The higher the number of points, the higher the performance.

R&S®HMF25xx Arbitrary Function Generator

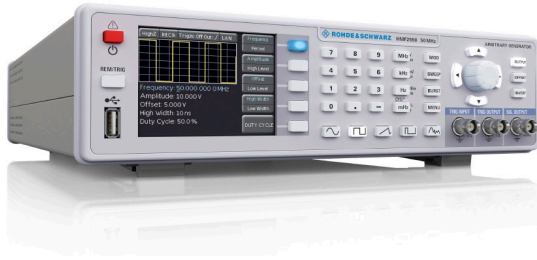

Accurate, versatile and affordable

- ▶ Two models: the R&S®HMF2525 with 25 MHz and the R&S®HMF2550 with 50 MHz maximum frequency
- ▶ 14-bit resolution and 8 ns rise time
- ▶ As well as standard waveforms such as sine, rectangle and triangle, the instruments provide powerful arbitrary signal functionality. In addition to predefined signal shapes such as sin(x)/x, white or pink noise, they can also output customer-specific, arbitrary shapes with a signal length of up to 256 ksample
- ▶ The burst, sweep, gating, internal and external triggering operating modes and the AM, FM, PM, PWM and FSK modulation functions (in each case internal and external) can be applied to all signals

Model overview						
Model	Frequency range	Output voltage	Total harmonic distortion	Arbitrary waveform vertical resolution	Arbitrary waveform signal memory length	Interface
R&S®HMF2525	10 µHz to 25 MHz	5 mV to 10 V (peak-to-peak) (into 50 Ω) 10 mV to 20 V (peak-to-peak) (open circuit)	0.04% (typ.) (f ≤ 100 kHz)	14 bit	up to 256k points	dual-interface USB/RS-232, optional interfaces LAN/USB and IEEE-488 (GPIB)
R&S®HMF2550	10 µHz to 50 MHz	5 mV to 10 V (peak-to-peak) (into 50 Ω) 10 mV to 20 V (peak-to-peak) (open circuit)	0.04% (typ.) (f ≤ 100 kHz)	14 bit	up to 256k points	

Important facts		
Specification	R&S®HMF2525/R&S®HMF2550	Why this is important
Widest measurement range across all functions	<p>R&S®HMF2525:</p> <ul style="list-style-type: none"> ▶ sine: 10 µHz to 25 MHz ▶ square: 10 µHz to 25 MHz ▶ pulse: 100 µHz to 12.5 MHz ▶ ramp/triangle: 10 µHz to 5 MHz ▶ arbitrary: 100 µHz to 12.5 MHz <p>R&S®HMF2550:</p> <ul style="list-style-type: none"> ▶ sine: 10 µHz to 50 MHz ▶ square: 10 µHz to 50 MHz ▶ pulse: 100 µHz to 25 MHz ▶ ramp/triangle: 10 µHz to 10 MHz ▶ arbitrary: 100 µHz to 25 MHz 	Allows utilization of the function generator for more applications and use cases.
Crisp color display	3.5" color TFT QVGA	See crisp representation of the waveform and all parameters.

Scope of delivery
<ul style="list-style-type: none"> ▶ User manual ▶ Power cord ▶ 3 year warranty

Recommended options/accessories	
Description	Type
Options and system components	
Dual Ethernet/USB interface	R&S®HO732
IEEE-488 (GPIB) interface	R&S®HO740
19" rackmount kit, 2 HU	R&S®HZ42



The perfect choice for:	
Engineering lab	Maintenance and repair
Education	General purpose

Your benefit	Features
Powerful pulse generator	Provides pulses with a recurrence rate of up to 12.5 MHz/25 MHz; the pulse width can be set from 15 ns to 999 s with a resolution of 5 ns. Rise/fall time can be selected from 8 ns to 500 ns – a very useful feature when characterizing input hysteresis of semiconductor devices
Easily create arbitrary waveforms	Arbitrary waveforms can be developed with PC software. Stored waveforms can be loaded via the front USB port or imported via the complementary HMEplorer software (available for download)

Signal generators

Signal examples

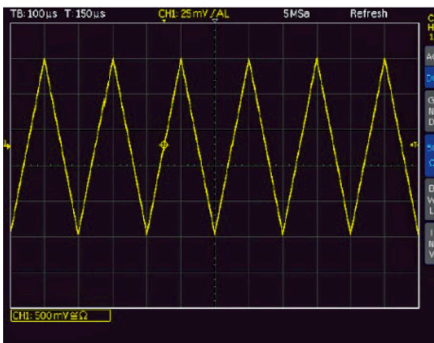

Triangle signal

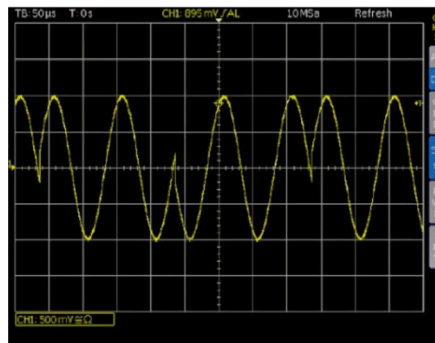

Phase modulation (PM)

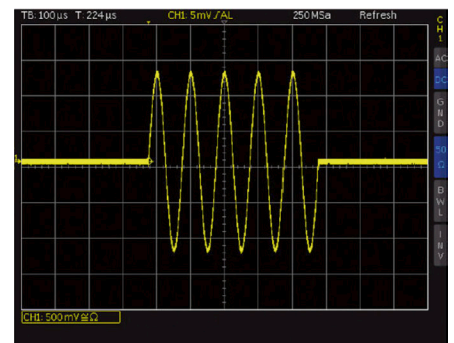

Burst example

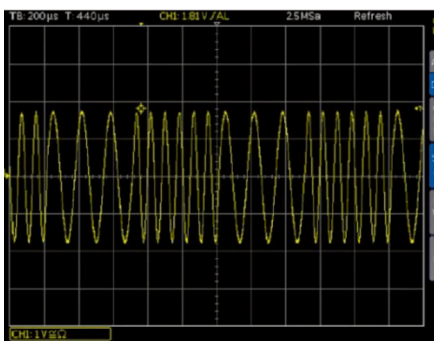

Frequency shift keying (FSK)

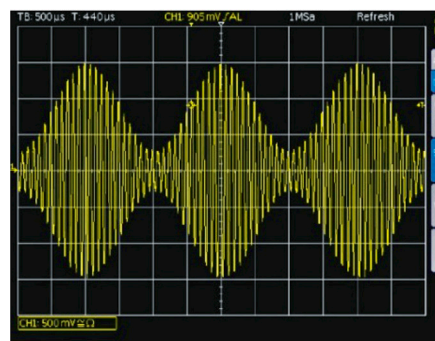

Amplitude modulation (AM)

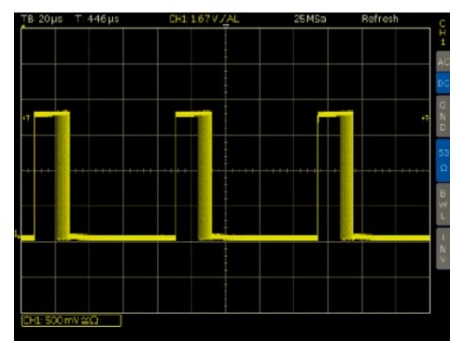

Pulse width modulation (PWM)

R&S®SMCV100B Vector Signal Generator



Maximum flexibility in applications and in production

The R&S®SMCV100B features a new Direct-RF DAC concept for RF signal generation. This concept enables I/Q modulation and up-conversion in the digital domain which eliminates I and Q imbalance errors and the LO leakage known from traditional analog I/Q modulators.

The R&S®SMCV100B options concept is fully software defined. No hardware options need to be selected for full functions of the available instrument. This includes upgrades to the RF frequency, memory, I/Q modulation bandwidth and for a wide variety of applications.

Model overview

Model	Frequency	RF output power	Phase noise	Display
R&S®SMCV100B	4 kHz to 3/6/7.125 GHz	up to +25 dBm	< -125 dBc (f = 1 GHz, 10 kHz offset)	5" touch display (800 × 480 pixel)

Important facts

Specification	R&S®SMCV100B	Why this is important
Multistandard platform	multistandard platform for automotive, broadcast, navigation and wireless applications with numerous digital standards	Since only one instrument is needed for a wide variety of applications, it has the flexibility for deployment at any time for other tasks on a production line. This minimizes potential unused capacity and allows a massive reduction of downtime on production lines.
Frequency range	4 kHz up to 7.125 GHz	To cover the DUT frequency range.
Phase noise	< -125 dBc	A generator with lower phase noise will add less unwanted noise to the DUT, revealing its true performance. Test the device, not the generator.
RF output power	up to +25 dBm	A higher power level allows a wider range of testing. Extra power enables the user to compensate for fixtures and cables between the generator and the test point, and removes the need for external amplifiers.

Scope of delivery

- ▶ Power cable
- ▶ Quick start guide
- ▶ 3 year warranty

Recommended options/accessories

Description	Type
Frequency options	
4 kHz to 3 GHz	R&S®SMCVB-B103
Frequency extension to 6 GHz	R&S®SMCVB-KB106
Frequency extension to 7.125 GHz	R&S®SMCVB-KB107
RF options	
High output power	R&S®SMCVB-K31
Low phase noise	R&S®SMCVB-K709

Recommended options/accessories

Digital standards (cellular)

5G NR Release 15	R&S®SMCVB-K444
5G NR Release 16	R&S®SMCVB-K448
5G NR Release 17	R&S®SMCVB-K471
5G NR Sidelink	R&S®SMCVB-K470
LTE Release 8	R&S®SMCVB-K255
LTE Release 9	R&S®SMCVB-K284
LTE Release 10	R&S®SMCVB-K285
LTE Release 11	R&S®SMCVB-K412
LTE Release 12	R&S®SMCVB-K413
LTE Release 13/14/15	R&S®SMCVB-K419
Cellular IoT Release 13	R&S®SMCVB-K415
Cellular IoT Release 14	R&S®SMCVB-K443
Cellular IoT Release 15	R&S®SMCVB-K446
3GPP FDD	R&S®SMCVB-K242
3GPP FDD HSPA/HSPA+, enhanced BS/MS tests	R&S®SMCVB-K283
GSM/EDGE	R&S®SMCVB-K240
EDGE Evolution	R&S®SMCVB-K241



The perfect choice for:	
General purpose	Labs
EMC testing and validation	Manufacturing

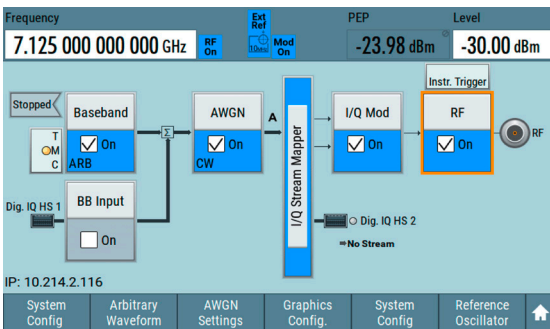

Graphical user interface with block diagram: Instantly see the signal flow in the R&S®SMCV100B as well as the instrument input and output states. An integrated graphic function displays the generated signal in real time.

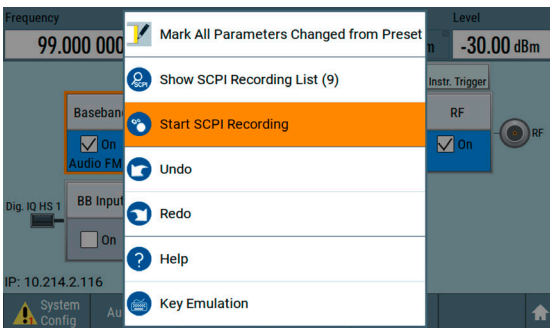

Built-in SCPI macro recorder: The integrated SCPI macro recorder with built-in code generator allows users to automatically record all manual settings and create a directly executable MATLAB® script.

Your benefit	Features
First multistandard platform for automotive, broadcast, navigation and wireless applications	<ul style="list-style-type: none"> ▶ Frequency range from 4 kHz to 7.125 GHz <ul style="list-style-type: none"> - Modern RF signal generation concept - Direct RF upconversion from 4 kHz to 2.5 GHz - Modulation bandwidth up to 240 MHz ▶ Powerful internal baseband generator <ul style="list-style-type: none"> - Real-time broadcast coder - Custom digital modulation - Internal baseband signal generation with ARB ▶ I/Q streaming capabilities <ul style="list-style-type: none"> - Playback of long I/Q sequences from solid state disk drive for EMC testing ▶ Support of R&S®WinIQSIM2 waveform generation <ul style="list-style-type: none"> - Wireless standards such as 5G NR, LTE, non-cellular IoT, Wi-Fi (IEEE 802.11) - Navigation standards for functional Go/NoGo tests and predefined position fix tests
Maximum flexibility in production	<ul style="list-style-type: none"> ▶ From functional end-of-line testing (EOLT) to application-specific device software testing ▶ Temporary and transferable software licenses ▶ Fully software defined signal generation for easy upgrading at customer site ▶ Standardization of production lines with a single vector signal generator ▶ Minimizes downtime of production lines
User friendly in any detail	<ul style="list-style-type: none"> ▶ Half a rack size, big performance, leading operation concept with block diagram ▶ 5" touch display (800 × 480 pixel) in a 2 HU instrument ▶ SCPI macro recorder

Signal generators

Recommended options/accessories	
Wireless connectivity standards	
IEEE 802.11a/b/g/n	R&S®SMCVB-K254
IEEE 802.11ac	R&S®SMCVB-K286
IEEE 802.11ax	R&S®SMCVB-K442
Bluetooth® EDR	R&S®SMCVB-K260
Bluetooth® 5.x	R&S®SMCVB-K417
LoRa®	R&S®SMCVB-K431
IEEE 802.11be	R&S®SMCVB-K447

Recommended options/accessories	
Digital standards (broadcast)	
DVB-H/DVB-T	R&S®SMCVB-K252
DAB/T-DMB	R&S®SMCVB-K253
DVB-S2/DVB-S2X	R&S®SMCVB-K416
Other standards and modulation systems	
Multicarrier CW signal generation	R&S®SMCVB-K261
Additive white Gaussian noise (AWGN)	R&S®SMCVB-K262
NFC A/B/F	R&S®SMCVB-K289
OFDM signal generation	R&S®SMCVB-K414

HANDHELD ANALYZERS

Frequency range

The frequency range specifies the range of frequencies over which the spectrum analyzer will operate. Different measurement applications may require a larger frequency range to evaluate harmonics, spurs or alternate channels. In this case, it makes sense to consider a higher frequency model in order to capture all potential signals of interest.

Application example: Detecting the third-order harmonics of a 915 MHz signal requires a spectrum analyzer of more than 2.745 GHz maximum frequency.

Upgradeability

All handheld analyzers have various upgrade options. The analyzer's capability can be increased to meet the task's requirements. Some models even offer frequency upgrades without having to add hardware. All upgrades are done via keycode, which eliminates the need to send the analyzer to a Rohde & Schwarz service center. There is no downtime.

A simple upgrade can transform a basic analyzer into a multitasking analyzer. If the function is only needed temporarily, a temporary license is also available.

Features and capabilities

Handheld analyzers provide a wide range of features and options to support different tasks in the field. Supported measurements include:

- ▶ Advanced spectrum measurements, e.g. channel power, occupied bandwidth, harmonic distortion
- ▶ Cable and antenna measurements, e.g. distance-to-fault, cable loss, VSWR
- ▶ Signal demodulation, e.g. AM/FM/PM demodulation and demodulation in line with specific wireless or mobile standards
- ▶ Vector signal analysis
- ▶ Spectrum monitoring and interference hunting

Some of these tasks require additional accessories, for example an antenna with the corresponding frequency range, a GPS receiver for position logging or a calibration kit for cable and antenna measurements.

Operating duration

To facilitate measurements anytime, anywhere, handheld analyzers must be mobile. All handheld analyzers are battery operated. Depending on the task, measurements can take a few minutes or even a day. Typically, a battery can last 3 hours to 4.5 hours. Thanks to state-of-the-art design concepts, the newer handheld analyzer generation consumes considerably less power. With a single charge, it is now possible to complete a full day's work in the field without having to take along an extra battery or look for a power source.

For longer operating periods (for example when a handheld spectrum analyzer is installed at a remote location for a week to perform spectrum recording), simply take out the battery and use a power adapter. If there is a power outage, the analyzer will automatically power up when AC power returns. There is no need to send someone to the site to power up the analyzer.

Type	Designation	Page
R&S®FSH	Handheld spectrum analyzer	51
R&S®Spectrum Rider FPH	Handheld spectrum analyzer	53
R&S®Cable Rider ZPH	Spectrum analyzer	55
R&S®ZVH	Cable and antenna analyzer	57
R&S®ZNH	Handheld vector network analyzer	59

Handheld analyzer portfolio



	R&S®FSH	R&S®FPH
Description	Handheld combination analyzer with spectrum analyzer up to 20 GHz and two-port vector network analyzer up to 8 GHz	Handheld spectrum analyzer up to 44 GHz
Performance	●●	●
Frequency models	9 kHz to 20 GHz (3.6/8/13.6/20 GHz models available)	5 kHz to 44 GHz (2/3/4/6/8/13.6/20/26.5/31/44 GHz models available)
Analysis bandwidth	–	–
Phase noise	–105 dBc (1 Hz) (f = 500 MHz, 30 kHz offset)	–95 dBc (1 Hz) (f = 500 MHz, 30 kHz offset)
DANL, at 1 GHz, preamplifier OFF	–146 dBm	–146 dBm
DANL, at 1 GHz, preamplifier ON	–165 dBm	–163 dBm
TOI	+15 dBm	+10 dBm
Highlights	Handheld combination analyzer: spectrum, full two-port vector network analyzer, power meter, cellular demodulation, interference hunting, EMI receiver mode, EMF measurement, vector voltmeter, pulse measurement	Handheld spectrum analyzer: spectrum, power meter, interference hunting, EMI receiver mode, pulse measurement, field strength meter, modulation analyzer (AM/FM/ASK/FSK), up to 9 h operating time
Dimensions	194 mm × 300 mm × 144 mm (7.6 in × 11.8 in × 5.7 in)	202 mm × 294 mm × 76 mm (8.0 in × 11.6 in × 3 in)

- The higher the number of points, the higher the performance.



R&S®ZVH	R&S®ZPH	R&S®ZNH
Handheld cable and antenna analyzer up to 8 GHz with optional vector network analyzer and spectrum analyzer	Handheld cable and antenna analyzer up to 4 GHz with optional spectrum analyzer	Cable and antenna analyzer
●●	●	
100 kHz to 8 GHz (3.6 GHz/8 GHz models available)	5 kHz to 4 GHz (3 GHz/4 GHz models available)	30 kHz to 26.5 GHz (4/8/18/26.5 GHz models available)
–	–	
–105 dBc (1 Hz) (f = 500 MHz, 30 kHz offset)	–95 dBc (1 Hz) (f = 500 MHz, 30 kHz offset)	
–146 dBm	–146 dBm	
–165 dBm	–163 dBm	
+10 dBm	+10 dBm	
Handheld combination analyzer: spectrum, cable and antenna, full two-port vector network analyzer, power meter, vector voltmeter	Handheld combination analyzer: spectrum, cable and antenna, power meter, interference hunting, pulse analyzer, signal generator, modulation analyzer (AM/FM/ASK/FSK), built-in bias tee, extremely fast boot and measurement time	Two-port handheld vector analyzer, cable and antenna measurement, full two-port S-parameter measurement, power sensor support, pulse measurement, vector voltmeter, power sensor versus frequency, time domain analysis
194 mm × 300 mm × 144 mm (7.6 in × 11.8 in × 5.7 in)	202 mm × 294 mm × 76 mm (8.0 in × 11.6 in × 3 in)	202 mm × 294 mm × 76 mm (8 in × 11.6 in × 3 in)

Handheld analyzers



R&S®FSH Handheld Spectrum Analyzer



Expandable platform that eliminates the need for multiple instruments

Depending on the model and options installed, the R&S®FSH can be used as a:

- ▶ Spectrum analyzer
- ▶ Interference hunting analyzer
- ▶ Cable and antenna analyzer
- ▶ Two-port vector network analyzer
- ▶ Power meter

Model overview

Model (frequency range)	Tracking generator	Preamplifier included	Resolution bandwidth	Phase noise	Level measurement uncertainty	DANL	TOI
R&S®FSH4 (9 kHz to 3.6 GHz)		•					> +10 dBm, +15 dBm (typ.)
R&S®FSH4 (9 kHz to 3.6 GHz)	•	•					
R&S®FSH4 (100 kHz to 3.6 GHz)	•	•				-161 dBm, -165 dBm (typ.)	
R&S®FSH8 (9 kHz to 8 GHz)		•					
R&S®FSH8 (9 kHz to 8 GHz)	•	•					
R&S®FSH8 (100 kHz to 8 GHz)	•	•	1 Hz to 3 MHz	-95 dBc (1 Hz), -105 dBc (1 Hz) (typ.)	up to 1 dB, 0.5 dB (typ.)		
R&S®FSH13 (9 kHz to 13.6 GHz)		•					
R&S®FSH13 (9 kHz to 13.6 GHz)	•	•					
R&S®FSH20 (9 kHz to 20 GHz)		•					
R&S®FSH20 (9 kHz to 20 GHz)	•	•				-158 dBm, -162 dBm (typ.)	> +3 dBm, +10 dBm (typ.)

Important facts

Specification	R&S®FSH	Why this is important
Demodulation	GSM/GPRS/EDGE, WCDMA, TD-SCDMA CDMA2000®, 1xEV-DO, LTE TDD, LTE FDD	Allows modulation measurements on relevant wireless standards.
VNA support	full two-port	Allows for cable loss and antenna testing and characterization, as well as distance to fault measurements. Two-port capability increases accuracy of transmission measurements.
Wizard support for common measurement functions	•	Increases repeatable field test patterns and reduces user error.
Entry level model	3.6 GHz	Determines lowest cost entry point into the family.
Preamplifier	•	Increases sensitivity for low signal level measurements.

Scope of delivery

- ▶ Lithium-ion battery pack
- ▶ USB cable
- ▶ LAN cable
- ▶ AC power supply
- ▶ User manual
- ▶ 3 year warranty (one year for battery and accessories)

Recommended options/accessories

Description	Type
EMF measurement application	R&S®FSH-K105
Pulse measurements with power sensor ^{1), 2)}	R&S®FSH-K29
Interference analysis	R&S®FPH-K15
Geotagging measurement application ¹⁾	R&S®FSH-K16
Receiver mode and channel scan measurement application	R&S®FSH-K43
Lithium-ion battery pack, 6.75 Ah	R&S®HA-Z206
Near-field probes	R&S®HZ-15
Yagi antenna, 824 MHz to 960 MHz	R&S®HA-Z900
Yagi antenna, 1710 MHz to 1990 MHz	R&S®HA-Z1900
Segmented sweep	R&S®FSH-K20

¹⁾ Software license.

²⁾ Requires R&S®FSH-Z129 for R&S®FSH4/8/13/20 with serial numbers < 121000.



The perfect choice for:	
Installation and maintenance of transmitter stations	EMI debugging/ RF design validation
Interference hunting	Electromagnetic fields measurements

Your benefit	Features
An expandable platform for every RF handheld measurement application	Expanded modes of operation for field strength measurements, power measurements, network analysis, interference analysis, vector voltmeter, pulse measurements
Extensive support for numerous wireless technologies	Modulation analysis for cellular technologies, including over-the-air LTE-Advanced carrier aggregation signal analysis
Most efficient instrument in the field	<ul style="list-style-type: none"> ▶ Sunlight readable display ▶ Generation of user-defined test sequences (R&S®FSH wizard) ▶ Wizard streamlines test development ▶ Remote control and data export with free R&S®Instrument View software ▶ Fast measurement mode switching ▶ SD card and USB port for data storage



Vector network analyzer mode: For cable loss and antenna testing and characterization as well as distance to fault measurements. Two-port capability for transmission measurements



Wizard function support for common measurements: User-definable test sequences that reduce operating errors in the field

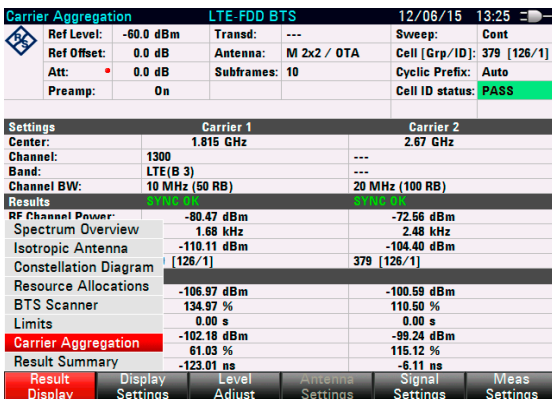

Support of numerous wireless communications standards: Modulation measurements on GSM/GPRS/EDGE, WCDMA, TD-SCDMA CDMA2000®, 1xEV-DO, LTE TDD, LTE FDD



Remote control via LAN or USB: The R&S®FSH can be remotely controlled via the USB or LAN interface and integrated into user-specific programs



R&S®Spectrum Rider FPH Handheld Spectrum Analyzer



The three key Ps for lab and field environments

Performance: excellent DANL and phase noise

- ▶ Weak signals can be easily captured

Portability: weighs as little as 2.5 kg

- ▶ Carrying holster (R&S®HA-Z322) to free up hands
- ▶ Side strap included for easy transportation
- ▶ Selection of carrying cases available

Price: low starting price and optional software keycode upgrades

- ▶ Competitive and attractive price
- ▶ No downtime, no recalibration needed

Model overview

Model	Frequency range	Preamplifier	Resolution bandwidth	Phase noise (f = 500 MHz, 1 MHz offset)	Level measurement uncertainty	DANL	TOI
.02 + R&S®FPH-B3 + R&S®FPH-B4	5 kHz to 2 GHz up to 3 GHz up to 4 GHz	optional	1 Hz to 3 MHz	-125 dBc (1 Hz)	0.5 dB (typ.)	-163 dBm (typ.)	+10 dBm (typ.)
.06 + R&S®FPH-B8	5 kHz to 6 GHz up to 8 GHz						
.13/.23 + R&S®FPH-B20	5 kHz to 13.6 GHz up to 20 GHz			▶ model .13: -125 dBc (1 Hz) ▶ model .23: -125 dBc (1 Hz)			
.26/.36 R&S®FPH-B31	5 kHz to 26.5 GHz up to 31 GHz			▶ model .26: -125 dBc (1 Hz) ▶ model .36: -125 dBc (1 Hz)			
.44/.54	5 kHz to 44 GHz			-120 dBc (1 Hz)			

Important facts

Specification	R&S®Spectrum Rider FPH	Why this is important
Software upgradeable frequency ranges	•	Investment protection. Allows users to buy only what they need, when they need it.
Touchscreen (capacitive)	•	Allows faster measurement setup and configuration. Ability to pinch and zoom to set span.
Backlit keypad	•	Ability to use the equipment in all lighting conditions.
Fanless design	•	Quiet operation, sealed to protect against dust and water.

Scope of delivery

- ▶ Lithium-ion battery pack
- ▶ Side strap for your hand
- ▶ Power cord
- ▶ USB cable
- ▶ User manual
- ▶ 3 year warranty (one year for battery and accessories)

Recommended options/accessories

Description	Type
Spectrum analyzer 100 Hz frequency extension, from 5 kHz down to 100 Hz ¹⁾	R&S®FPH-B29
Analog modulation analysis AM/FM	R&S®FPH-K7
Power sensor support	R&S®FPH-K9
Channel power meter	R&S®FPH-K19
Pulse measurements with power sensor	R&S®FPH-K29
Interference analysis	R&S®FPH-K15
Signal strength mapping	R&S®FPH-K16
Receiver mode	R&S®FPH-K43
EMF measurement application	R&S®FPH-K105



¹⁾ For serial number ≥ 103100.
Not applicable to R&S®Spectrum Rider FPH model .02.

The perfect choice for:	
Spectrum clearance (5G ready)	Interference hunting
Pulse measurement	EMI debugging and RF design validation

Your benefit	Features
Battery life twice that of today's handheld spectrum analyzers	<ul style="list-style-type: none"> ▶ models .02/.06/13/.26: > 6 h battery life ▶ models .23/.36/44/.54: 4.5 h battery life
Smartphone style capacitive touchscreen; also available with traditional interface	<ul style="list-style-type: none"> ▶ 7" antiglare capacitive color touchscreen ▶ On-screen keyboard ▶ Smartphone-like gestures ▶ Adjustable display brightness ▶ Backlit large button keypad ▶ Multifunction rotary knob
Buy only what you need; upgrade later without returning analyzer for servicing	<ul style="list-style-type: none"> ▶ Selection of 2/6/13.6/26.5 GHz base models ▶ Frequency upgrade keycode options available for each base model ▶ Channel power meter keycode option

Battery life comparison (in hours)

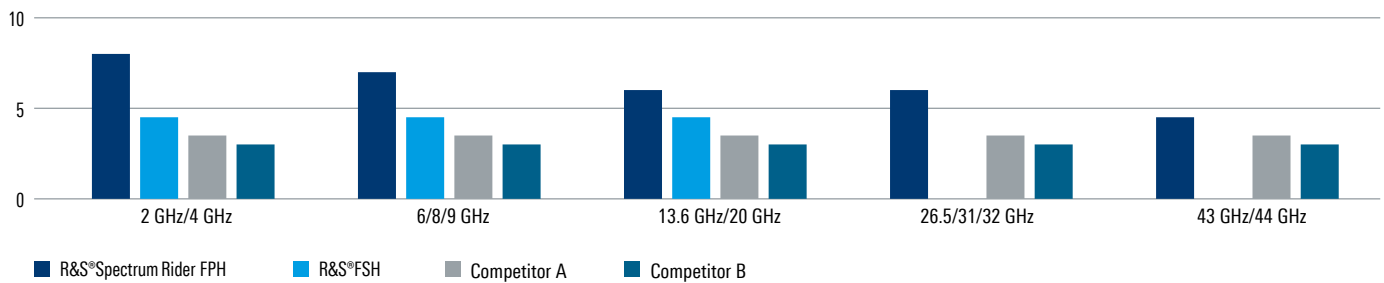

Price comparison (in EUR)

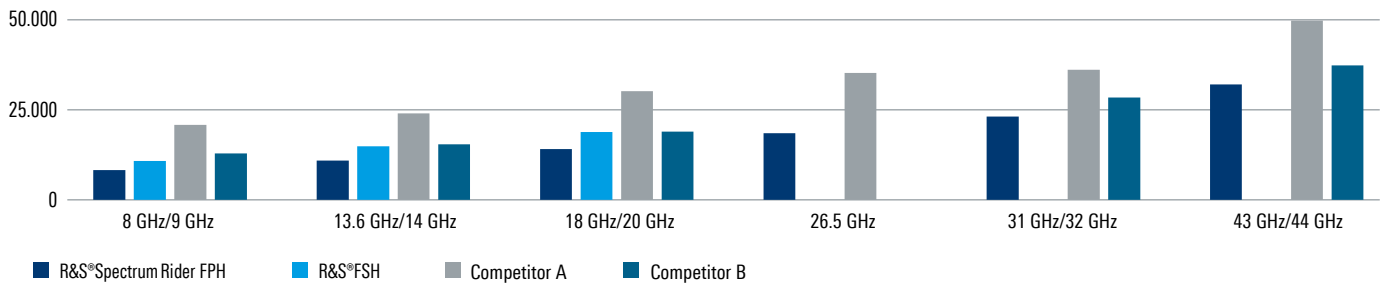

Lightweight design

Every additional gram adds to user fatigue in the field. Thanks to the state-of-the-art design, each unit weighs only 2.5 kg – regardless of the frequency range.

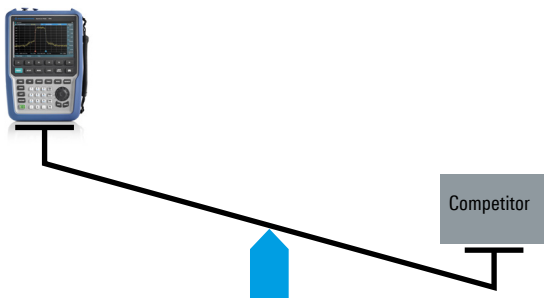

Performance and features

The R&S®SpectrumRider FPH has exceptional phase noise and DANL to capture known and unknown signals. The R&S®SpectrumRider FPH easily measures a wide range of parameters such as total harmonic distortion, occupied bandwidth, output power and channel power, making it the ideal tool for field work.

Other products to consider

- ▶ R&S®NRP power sensors: all models up to 110 GHz supported
- ▶ R&S®FSH: when you need digital modulation analysis



R&S®CableRider ZPH Cable and Antenna Analyzer



Save time in the field

The R&S®CableRider ZPH is a cable and antenna analyzer that is available in two models. The one-port model has all the essential basic measurement capabilities required for installing and maintaining antenna systems in the field. Its unique features ensure fast and efficient cable and antenna measurements. The two-port model offers more functionality and can perform spectrum analysis (R&S®ZPH-K1 option). It has an independent tracking source plus an integrated bias tee. All these add-ons make the R&S®CableRider ZPH the perfect field installation and maintenance tool.

Model overview

Model	Frequency range	Frequency extension	Measurement speed	Data points	Measurement mode (standard)	Measurement mode (optional)
R&S®ZPH one-port model (model .02)	2 MHz to 3 GHz				DTF, return loss, VSWR, one-port cable loss, Smith chart, phase	power meter, power measurement with power sensor, pulse measurement
R&S®ZPH two-port model (model .12)	<ul style="list-style-type: none"> ▶ CAT mode: 2 MHz to 3 GHz ▶ spectrum mode: 5 kHz to 3 GHz 	up to 4 GHz (R&S®ZPH-B4 option)	0.3 ms/point	101 to 2501	DTF, return loss, VSWR, one-port cable loss, Smith chart, phase, S_{21}	power meter, power measurement with power sensor, pulse measurement, spectrum analysis, interference analysis, AM/FM/ASK/FSK modulation analysis

Important facts

Specification	R&S®ZPH	Why this is important
Measurement speed	0.3 ms/point	Total overall test time is an important parameter impacted greatly by measurement speed. Faster measurement time per point increases overall throughput. This is especially important if hand-tuning of devices (antennas, resonators) is required.
Battery operation time	up to 6.5 h/9 h (mode dependent)	The advantages of having a long-lasting battery are obvious – no need to bring an extra battery with additional weight when climbing up a mast or tower, no dead batteries during measurement.
Automatic calibration unit	● ¹⁾	With little or no VNA experience, users can make a valid calibration and accurate measurements. An auto-cal unit also eliminates the need to deal with individual open, short, match and through calibration standards. Auto-cal based calibrations can be performed in the field or the lab to ensure consistent and reliable results.
Capacitive touchscreen with gesture support	●	Intuitive (smartphone-like) operation. Allows faster measurement setup and configuration. Ability to pinch and zoom to set span.

¹⁾ With R&S®ZN-Z103 calibration unit.

Scope of delivery

- ▶ Power cord
- ▶ Lithium-ion battery pack
- ▶ 3 year warranty (one year for battery and accessories)

Recommended options/accessories

Description	Type
Frequency upgrade (3 GHz to 4 GHz)	R&S®ZPH-B4
Spectrum analyzer preamplifier (requires R&S®ZPH-K1)	R&S®ZPH-B22
Calibration unit, one-port, 2 MHz to 4 GHz	R&S®ZN-Z103
Combined open/short/50 Ω load calibration standard, for calibrating VSWR and DTF measurements, DC to 3.6 GHz	R&S®FSH-Z29
Soft carrying bag	R&S®HA-Z220
Rainproof carrying holster	R&S®HA-Z322



The perfect choice for:	
Installation and maintenance of AM/FM radio stations	Spectrum clearance/interference hunting ¹⁾
RF cable testing	Antenna measurement

¹⁾ Only with two-port model.

Your benefit	Features
Hybrid operation	Large keypads and sensitive capacitive touchscreen
Make the right measurement right away	Wizard function, settings preconfigured in advance
One-step calibration	No toggling between O/S/L standards with the R&S®ZN-Z103 automatic calibration unit
Shortest test time	Fastest measurement speed (0.3 ms/point), short boot and warm-up times
Work under bright or dim conditions	Non-reflective display with adjustable backlight, illuminated keypad
Buy what you need when you need it	Upgrade via keycode, no downtime, no recalibration required
Simple wireless remote operation	Free downloadable Android/iOS apps (third-party wireless router required)

Handheld analyzers

More functions

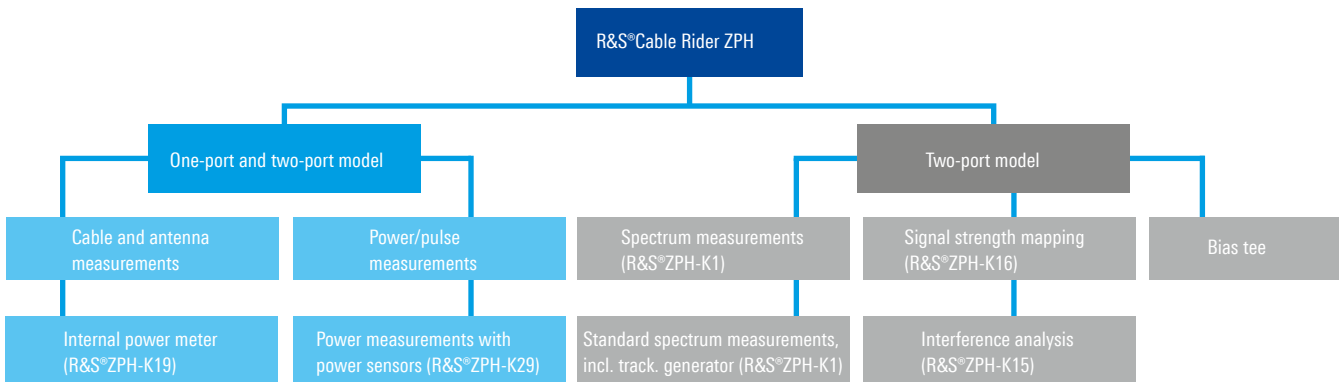

Remote wireless control apps

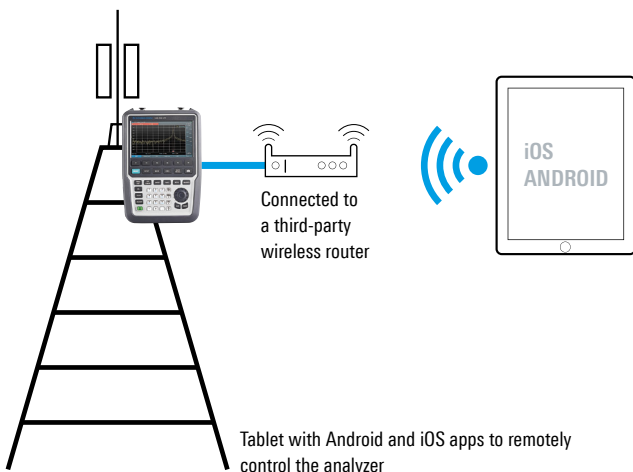

One-step calibration with automatic calibration unit (R&S®ZN-Z103)



Combined OSL calibration kit (R&S®FSH-Z29)

Perform convenient cable and antenna measurements with the R&S®ZVH wizard and report generator



R&S®ZVH Cable and Antenna Analyzer



For more efficiency in the field

Depending on the options installed, the R&S®ZVH can be a cable and antenna analyzer, a two-port vector network analyzer, a power meter or a spectrum analyzer. Free software and apps are available to conveniently remote control the analyzer. The wizard function also allows users to preconfigure test sequences for repeatability and reduce measurement and troubleshooting time.

Model overview

Model (frequency range)	Number of ports	Dynamic range	Port output power	Data points	Measurement mode (standard)
R&S®ZVH4 (100 kHz to 3.6 GHz)	2	100 dB	0 dBm to -40 dBm	101 to 1201	reflection, DTF, one-port cable loss
R&S®ZVH8 (100 kHz to 8 GHz)	2	100 dB	0 dBm to -40 dBm	101 to 1201	reflection, DTF, one-port cable loss

Important facts

Specification	R&S®ZVH	Why this is important
Factory calibration available	•	Ensures accurate measurements even if the field technician forgets the calibration procedure.
Wizard support for common measurement functions	•	Increases repeatable field test patterns and reduces user errors.
Entry bandwidth	3.6 GHz	Determines lowest cost entry point into the family.
Preamplifier	included	Increases sensitivity for low signal level measurements.

Scope of delivery

- ▶ Lithium-ion battery pack
- ▶ LAN cable
- ▶ USB cable
- ▶ AC power supply
- ▶ CD-ROM with software and documentation
- ▶ Quick start guide
- ▶ 3 year warranty (one year for battery and accessories)

Recommended options/accessories

Description	Type
Options	
Remote control via LAN or USB	R&S®ZVH-K40
Transmission measurement	R&S®ZVH-K39
Vector network analysis	R&S®ZVH-K42
Vector voltmeter	R&S®ZVH-K45
Spectrum analysis	R&S®ZVH-K1
Spectrogram measurement application	R&S®ZVH-K14
Power meter	R&S®ZVH-K9
Popular accessories	
Combined open/short/50 Ω load calibration standard, DC to 8 GHz	R&S®FSH-Z28
Combined open/short/50 Ω load calibration standard, DC to 3.6 GHz	R&S®FSH-K29
Lithium-ion battery pack, 6.75 Ah	R&S®HA-Z206
Soft carrying bag	R&S®HA-Z220
Hard case	R&S®HA-Z321
GPS receiver	R&S®HA-Z240



The perfect choice for:	
Installation and maintenance of AM/FM radio stations	RF cable measurement
Antenna measurement	General purpose spectrum measurement

Your benefit	Features
Make the right measurement right away	Wizard function, preconfiguration of settings in advance
An expandable platform for every RF handheld measurement application	Expanded modes of operation for field strength measurements, power measurements, network analysis, vector voltmeter, pulse measurements
Simple wireless remote operation	Free downloadable Android/iOS apps, R&S®MobileView (third-party wireless router required)
Most efficient instrument in the field	<ul style="list-style-type: none"> ▶ Sunlight readable display ▶ Wizard streamlines test development ▶ Remote control and data export with free R&S®Instrument View software ▶ Fast switching of measurement modes ▶ SD card and USB port for data storage

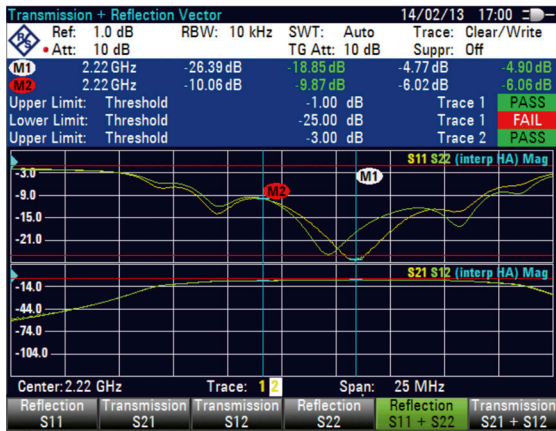

Vector network analysis: Simultaneous display of four S-parameters (S_{11} , S_{21} , S_{12} , S_{22})

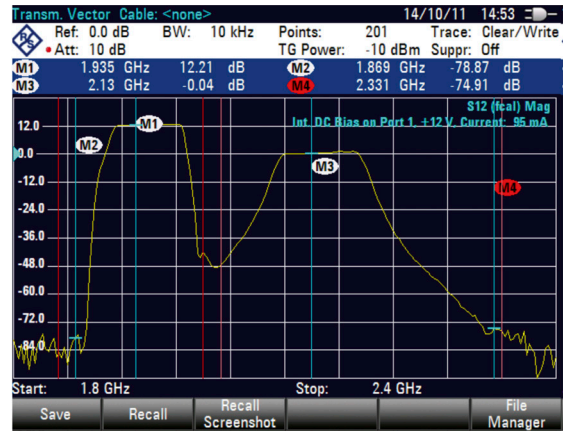

Two-port capability for transmission measurements



Remote control via LAN or USB: The R&S®ZVH can be remotely controlled via the USB or LAN interface and integrated into user-specific programs.

Wizard function: Fast and accurate measurements in three simple steps

- 1 Project manager/expert creates the test sequences
- 2 Operator uses the wizard to execute the test sequences
- 3 Operator shows the measurement result to the project manager/expert and documents it

Remote wireless control apps

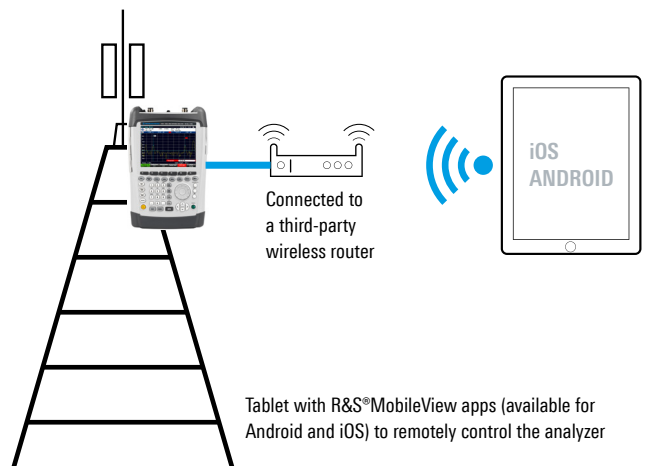

Handheld analyzers

R&S®ZNH Handheld Vector Network Analyzer



Lightweight design, heavyweight performance

R&S®ZNH is a full two-port handheld vector network analyzer that offers one-port cable and antenna measurement and full two-port S-parameter measurements. The touch based interface is simple to operate and a configuration overview menu makes measurement preparation more efficient. The R&S®ZNH may have a small form factor but it is complete in every detail and delivers high performance and all the key functions.

Model overview

Model, frequency range	Number of ports	Basic functions	Dynamic range	Max. port output power	Trace noise	Measurement points
R&S®ZNH4, 30 kHz to 4 GHz	2	DTF, one-port cable loss, VSWR, return loss, S_{11} , S_{21} , S_{12} , S_{22} (magnitude and phase)	up to 100 dB (typ.)	up to 0 dBm (meas.) (300 kHz ≤ f ≤ 24 GHz)	<ul style="list-style-type: none"> ► magnitude (RMS): 0.0015 dB to 0.0040 dB (typ.) ► phase (RMS): 0.015° to 0.025° (typ.) 	16001
R&S®ZNH8, 30 kHz to 8 GHz						
R&S®ZNH18, 30 kHz to 18 GHz						
R&S®ZNH26, 30 kHz to 26.5 GHz						

Important facts

Specification	R&S®ZNH	Why this is important
Dynamic range	up to 100 dB (typ.)	This allows the instrument to accommodate large variations between the maximum and minimum power levels in a measurement.
Battery operating time	4 h	Long battery life means saves weight by eliminating the need for a spare battery in the field, while still having plenty of power for measurements.
Display	7" capacitive WVGA touchscreen with gesture support	Intuitive operation for faster measurement setup and configuration. Span is set with pinch and zoom.
Receiver architecture	The four-receiver architecture consists of two reference receivers and two test receivers at both port 1 and port 2.	The R&S®ZNH can support more advanced calibration types such as unknown through, open, short and match (UOSM) calibration. Such calibration is useful for DUTs with different input or output connector types at the test ports.

Scope of delivery

- Power cable
- Quick start guide
- 3 year warranty

Recommended options/accessories

Description	Type
Calibration kit, type N (m), 50 Ω, 0 Hz to 18 GHz	R&S®ZN-Z170
Calibration kit, type N (f), 50 Ω, 0 Hz to 18 GHz	R&S®ZN-Z170
Calibration kit, 3.5 mm (m), 50 Ω, 0 Hz to 26.5 GHz	R&S®ZN-Z135
Calibration kit, 3.5 mm (f), 50 Ω, 0 Hz to 26.5 GHz	R&S®ZN-Z135
Calibration kit, 50 Ω, 2 MHz to 4 GHz	R&S®ZN-Z103
Calibration kit, 50 Ω, 1 MHz to 6 GHz	R&S®ZN-Z103
Soft carrying bag	R&S®HA-Z220
Carrying holster	R&S®HA-Z322



The perfect choice for:

Field testing	R & D
Education	Manufacturing

Highlights

- ▶ Unknown through calibration (UOSM) is possible
- ▶ Various calibration kits are supported
- ▶ Calibration kit information can be entered manually with R&S®InstrumentView software

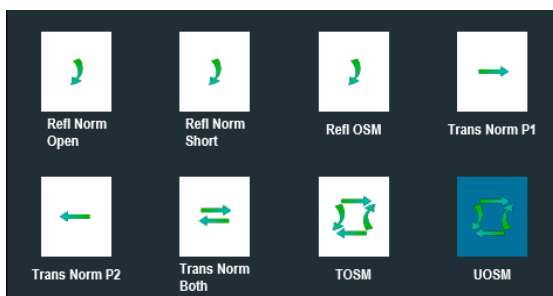

Simple to operate

Intuitive operation using smartphone-like touch gestures

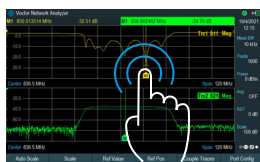

Add a marker with a double tap

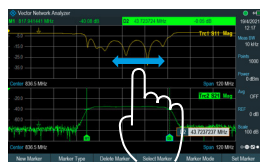

Move a marker by dragging the marker label

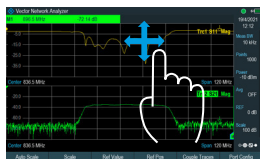

Delete a marker by crossing it out

Simple to configure

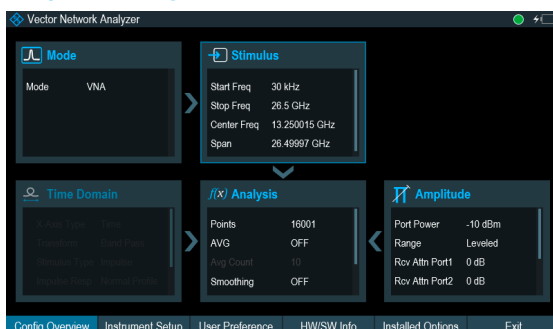

Configurable dashboard for fast parameter setting

Your benefit	Features
Additional protection from overloading without external attenuator	Built-in receiver step attenuator with attenuation from 0 dB to 15 dB in 5 dB steps
Directly calibrate DUTs with different input/output connectors	Using UOSM calibration
Easy operation	<ul style="list-style-type: none"> ▶ Intuitive touchscreen controls smartphone-like touch gestures ▶ Adjustable display brightness and backlit keypad for bright sunlight or dim environments ▶ Wizard function automates test sequences so that recurring measurements are quick, easy and mistake-free ▶ Battery life of four hours when fully charged ▶ Configurable dashboard with overview menu for quick measurement setup and 70% fewer taps
Easy configuration	<ul style="list-style-type: none"> ▶ Flexible calibration approach ▶ Numerous calibration standards and kits are supported. Calibration kit information can be easily entered manually with R&S®InstrumentView software
More functionality	<ul style="list-style-type: none"> ▶ Many functions come standard, such as one-port cable and antenna analysis and full S-parameter measurement ▶ Buy only what you need – options can be ordered independently and without prerequisites ▶ Four-receiver architecture

Handheld analyzers

Preconfigure in three simple steps

Eliminate measurement errors due to wrong inputs

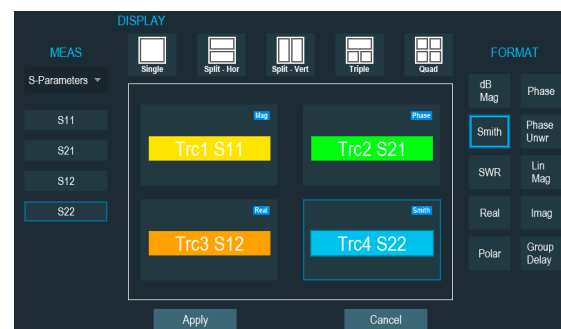
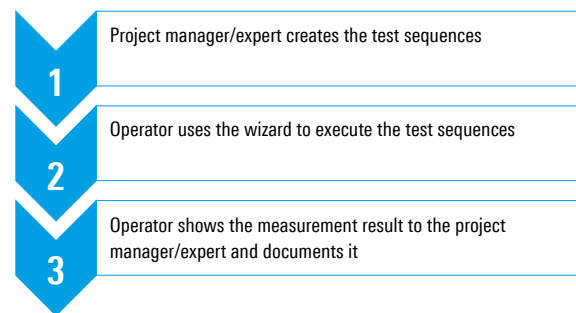

Just a few taps to configure the measurement display and format

SPECTRUM ANALYZERS

The Rohde & Schwarz spectrum analyzer portfolio offers options ranging from low-cost, yet powerful 1 GHz analyzers to full-featured 85 GHz spectrum analyzers. Designed by the RF experts at Rohde & Schwarz, the spectrum analyzers feature exceptional signal integrity, high value and excellent reliability.

Use the table on pages Seite 63 and 74 to see the differences between each family.

Frequency range

The frequency range specifies the range of frequencies over which the spectrum analyzer will operate. Different measurement applications may require a larger frequency range to evaluate harmonics, spurs or alternate channels. In this case, it makes sense to consider a higher frequency model in order to capture all potential signals of interest.

Application example: Detecting the third-order harmonics of a 915 MHz signal requires a spectrum analyzer with a maximum frequency greater than 2.745 GHz.

Dynamic range

The dynamic range is the analyzer's ability to detect weak signals in the presence of strong signals. The dynamic range is limited on the lower end by the analyzer's inherent noise and spurs and on the upper end by nonlinearities. The inherent noise is specified by the displayed average noise level (DANL), given in dBm and normalized to 1 Hz resolution bandwidth.

The nonlinearities are given by the 1 dB compression point, second harmonic distortion and third-order intercept (TOI).

A preamplifier reduces the DANL, which helps detect weak signals but increases other distortions and reduces the overall dynamic range.

An input attenuator with a small step size helps use the maximum dynamic range.

Application example: Spurious emission measurements, EMI debugging: To detect a weak signal of -100 dBm with a resolution bandwidth of 10 kHz and a signal to noise ratio (SNR) of 10 dB, the DANL must be below -110 dBm/10 kHz, which is equivalent to -150 dBm (1 Hz).

Maximum input level



1 dB compression of 1st mixer



Optimum mixer level

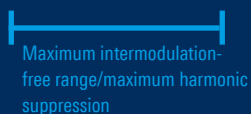

Features and capabilities

Modern spectrum analyzers provide a wide range of options for enhanced signal analysis and ease of use. Possible firm-ware or software options include:

- ▶ Advanced spectrum measurements, e.g. spectrogram, channel power, occupied bandwidth, third-order intercept point
- ▶ I/Q analysis mode with a specific analysis bandwidth for capturing and analyzing signals, including phase information
- ▶ Software for signal demodulation, e.g. AM/FM/PM demodulation, vector signal analysis, signal demodulation in line with specific wireless or mobile standards
- ▶ Certain use cases and measurements require dedicated hardware. Possible hardware options include:
 - Battery operation or 12 V/24 V DC power for portable or vehicular operation
 - Tracking generator for scalar network analysis
 - 28 V DC output for noise figure measurements with a noise source
 - Remote control requires a IEEE-488 (GPIB), LAN or WLAN interface

Application example: Amplitude transmission measurements on an RF filter require a tracking generator.

Phase noise

The spectrum analyzer's inherent phase noise limits measurements very close to a carrier since spurs at e.g. 1 kHz offset may be hidden in the analyzer's phase noise. The inherent phase noise also limits the ability to perform phase noise measurements on the signal source and it impacts error vector magnitude (EVM) measurements on digitally modulated signals, especially narrowband signals.

Application example: To detect a spur at a certain frequency offset at 70 dB below the carrier with a 10 dB SNR and 10 Hz RBW, the SSB phase noise must be below -90 dBc (1 Hz).

Type	Designation	Page
R&S®FPC	Spectrum analyzer	65
R&S®FSC	Spectrum analyzer	67
R&S®FPL1000	Spectrum analyzer	69

Economy spectrum analyzer portfolio

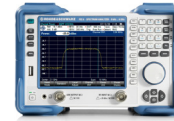

	R&S® FPC	R&S® FSC
	Bench spectrum analyzer with vector network analyzer and signal generator up to 3 GHz	Compact and cost-effective spectrum analyzer
Performance	•	•
Frequency models	5 kHz to 3 GHz (1/2/3 GHz models available)	9 kHz to 6 GHz (3 GHz/6 GHz models available)
Analysis bandwidth	–	–
Phase noise	–92 dBc (1 Hz) (f = 500 MHz, 30 kHz offset)	–95 dBc (1 Hz) (f = 500 MHz, 30 kHz offset)
DANL, at 1 GHz, preamplifier OFF	–150 dBm	–146 dBm
DANL, at 1 GHz, preamplifier ON	–165 dBm	–165 dBm
TOI	+10 dBm	+15 dBm
Highlights	Economy spectrum analyzer by combining the value of three instruments: spectrum analyzer, vector network analyzer, signal generator, EMI receiver mode, modulation analyzer (AM/FM/ASK/FSK)	Compact spectrum analyzer with great RF performance, small form factor
Dimensions	396 mm × 178 mm × 147 mm (15.6 in × 7.0 in × 5.8 in)	233 mm × 158.1 mm × 350 mm (9.2 in × 6.2 in × 13.8 in)

- The higher the number of points, the higher the performance.

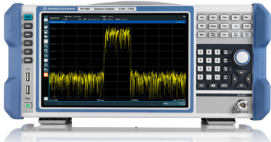

R&S® FPL1000

General purpose spectrum analyzer

•••

5 kHz to 3/7.5/14/26.5 GHz

40 MHz

< -105 dBc (1 Hz)
(f = 1 GHz, 10 kHz offset)

< -149 dBm

< -163 dBm

> 17 dBm

Battery, tracking generator;
signal analysis applications: noise, analog demodulation,
vector signal analyzer, NB-IoT (with R&S®VSE), EMI

408 mm × 186 mm × 235 mm
(16.06 in × 7.32 in × 9.25 in)

R&S®FPC Spectrum Analyzer



The value of three instruments in one

Signal generator

The R&S®FPC not only features standard tracking generator measurements with frequency offset functionality, its signal source is independent to enable signal generator functionality. A CW signal can be set within the frequency range, or in a coupled mode to follow the center frequency setting of the spectrum analyzer mode.

Spectrum analyzer

The R&S®FPC base instrument has a frequency range from 5 kHz to 1 GHz. With keycode options, it can be unlocked up to 3 GHz and other features can be activated. The R&S®FPC provides the best dynamic range in its class. In combination with RBW settings down to 1 Hz, it resolves the finest details, which are displayed on the high-resolution 10.1" WXGA display. Wired or wireless remote control options are available for free.

Network analyzer

The R&S®FPC features an internal VSWR bridge that makes purchasing and mounting/dismounting an external bridge unnecessary. S_{11} reflection measurements are supported, including Smith chart and DTF features.

Model overview

Model (frequency range)	Preamplifier included	Independent signal generator	Tracking generator	Resolution bandwidth	Phase noise	DANL	TOI
R&S®FPC1000 (5 kHz to 1 GHz)	optional	-	-	1 Hz to 3 MHz	< -103 dBc (1 Hz) (f = 500 MHz, 100 kHz offset)	down to -165 dBm (typ.) (with preamplifier)	+7 dBm
R&S®FPC-B2 (5 kHz to 2 GHz, frequency upgrade)							
R&S®FPC-B3 (5 kHz to 3 GHz, frequency upgrade)							
R&S®FPC1500 (5 kHz to 1 GHz)		•	•				
R&S®FPC-B2 (5 kHz to 2 GHz, frequency upgrade)							
R&S®FPC-B3 (5 kHz to 3 GHz, frequency upgrade)							

Important facts

Specification	R&S®FPC1000	R&S®FPC1500	Why this is important
DANL (normalized to 1 Hz)	< -165 dBm (typ.) (power amplifier = on)		Most "economy" spectrum analyzers sacrifice premium components and superior RF design choices in favor of cost reduction. True RF performance in an economy instrument gives you the confidence of the most accurate measurements within your frequency needs.
TOI	+17 dBm (attenuation = 10 dB)		
Phase noise at 100 kHz offset	< -103 dBc (1 Hz) (typ.)		Visualizing important signal details is not just a matter of the RF specifications; the high-resolution display of the R&S®FPC spectrum analyzers allows hardware signal details to be displayed on screen.
Display	10.1" (1366 × 768 pixel)		
Modulation analysis	spectrum analysis and modulation analysis		A wider range of both modulation and spectrum analysis allow the spectrum analyzer to pair more suitably with a larger range of applications. Modulation analysis can allow demodulation of simple modulation formats such as ASK/FSK as well as AM/FM.
Tracking generator	-	tracking generator model with the unique value of three instruments in one	A spectrum analyzer with tracking generator is most useful for scalar transmission measurements, for example on filters. The R&S®FPC1500 comes with an extra: frequency conversion measurements (enabled by the independent type source of the instrument). This is great for RF mixer characterization.



The perfect choice for:

R&D and service labs	Test automation
Professionals, hobbyists	Education and training

Your benefit	Features
Value of three	The R&S®FPC1500 combines the value of a spectrum analyzer, a vector network analyzer and a signal generator
More resolution for better measurements	Lowest noise floor in class down to -165 dBm (typ.) (with preamplifier), resolution bandwidth down to 1 Hz, 10.1" WXGA display
Investment protection	All upgrades available via keycode, no additional calibration required

Scope of delivery

- ▶ Power cable
- ▶ 3 year warranty (one year for accessories)

Recommended options/accessories

Description	Type
Spectrum analyzer frequency upgrade, 1 GHz to 2 GHz	R&S®FPC-B2
Spectrum analyzer frequency upgrade, 2 GHz to 3 GHz	R&S®FPC-B3
Spectrum analyzer preamplifier	R&S®FPC-B22
Wi-Fi connection support	R&S®FPC-B200
Wi-Fi USB nano flash drive	R&S®FPC-Z2

Recommended options/accessories

Description	Type
Modulation analysis	R&S®FPC-K7
Vector network analysis	R&S®FPC-K42
Receiver mode	R&S®FPC-K43
Advanced measurements	R&S®FPC-K55
19" rackmount kit	R&S®ZZA-FPC1
Near-field probes, 30 MHz to 3 GHz (set of 5 probes)	R&S®HZ-15
Amplifier, 100 kHz to 3 GHz	R&S®HZ-16
Near-field probes, 30 MHz to 3 GHz (set of 2 probes)	R&S®HZ-17
Carrying case	R&S®RTB-Z3

Highlights

Class-leading spectrum analyzer

✓ Value of three	✓ 10.1" display
✓ Low noise floor	✓ Flexible upgrade concept
✓ High max. input power	✓ Easy to control

Frequency extension using keycodes

Buy what you need when you need it.

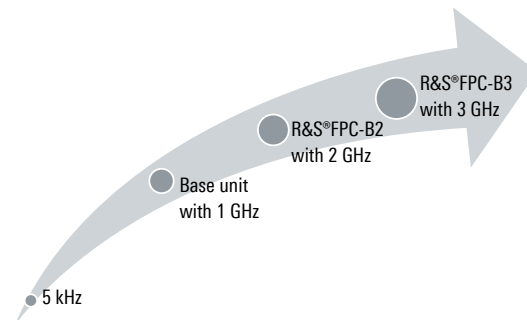

Spectrum analyzer

- Investment protection
- High resolution
- Easy virtual control

Vector network analyzer

- Internal VSWR bridge
- One-port VNA (S₁₁)
- Smith chart

Signal generator

- Tracking generator
- Independent signal source
- Coupled CW mode

Spectrum analyzers

R&S®FSC Spectrum Analyzer

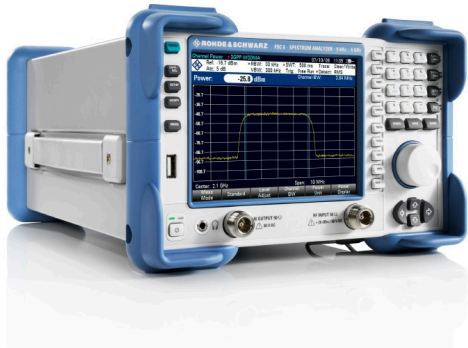

- ▶ **Compact form factor**
The R&S®FSC has the smallest footprint in its class at only 3 HU, 1/2 19". It takes up very little space on a bench. Two R&S®FSC analyzers or one R&S®FSC and an R&S®SMC signal generator fit in just 3 HU of rack space
- ▶ **Cost-effective**
Total cost of ownership is excellent due to affordable initial and calibration costs, plus very low operating cost with only 12 W power consumption

Compact and cost-effective spectrum analyzer

- ▶ **Performance**
 - The R&S®FSC features very good RF performance. Its DANL, TOI and phase noise make it ideal for many standard measurement applications
 - General purpose spectrum analysis presets for spectral characteristics, e.g. harmonics, AM modulation depth and ACLR are included as standard

Model overview							
Model	Frequency range	Preamplifier	Resolution bandwidth	Phase noise	Level measurement uncertainty	DANL	TOI
R&S®FSC3, model .03 (base)	9 kHz to 3 GHz	optional	10 Hz to 3 MHz	-95 dBc (1 Hz), -105 dBc (1 Hz) (typ.)	up to 1 dB, 0.5 dB (typ.)	-161 dBm, -165 dBm (typ.)	> +10 dBm, +15 dBm (typ.)
R&S®FSC3, model .13 (tracking gen.)	9 kHz to 3 GHz				up to 1.5 dB, 0.5 dB (typ.)	-161 dBm, -165 dBm (typ.)	> +10 dBm, +15 dBm (typ.)
R&S®FSC6, model .06 (base)	9 kHz to 6 GHz				up to 1.5 dB, 0.5 dB (typ.)	-155 dBm, -159 dBm (typ.)	> +3 dBm, +10 dBm (typ.)
R&S®FSC6, model .16 (tracking generator)	9 kHz to 6 GHz				up to 1.5 dB, 1 dB (typ.)	-155 dBm, -159 dBm (typ.)	> +3 dBm, +10 dBm (typ.)

Important facts

Specification	R&S®FSC	Why this is important
Tracking generator dynamic range	90 dB (typ.)	Provides higher dynamic range when performing filter measurements.
Phase noise		Lower phase noise enables greater signal detection accuracy close to the carrier.
30 kHz	up to -95 dBc (1 Hz)	
100 kHz	up to -100 dBc (1 Hz)	
1 MHz	up to -120 dBc (1 Hz)	

Recommended options/accessories

Description	Type
Preamplifier for spectrum analyzer	R&S®FSC-B22
19" rackmount kit for two R&S®FSC	R&S®ZZA-T33
19" rackmount kit for one R&S®FSC	R&S®ZZA-T34
Headphones	R&S®FSH-Z36
Near-field probes, 30 MHz to 3 GHz	R&S®HZ-15
Preamplifier for R&S®HZ-15, 100 kHz to 3 GHz	R&S®HZ-16



The perfect choice for:	
R&D service labs	Test automation
Professionals, hobbyists	Education and training

Your benefit	Features
Easy to set up	Owing to its compact design, the R&S®FSC only takes up minimal bench space
Easy to operate	All important settings are available via proper hardkeys, supplemented by softkeys at the bottom of the display
Wide choice	4 base models to fit customer needs

Highlights

Class-leading spectrum analyzer

✓ High RF performance	✓ Low power consumption
✓ Low noise floor	✓ Compact form factor
✓ High max. input power	✓ Easy to control

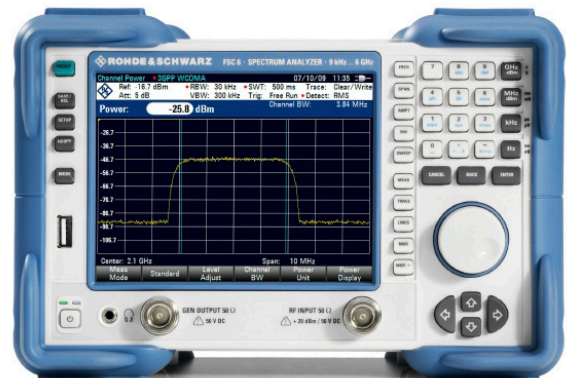

Tracking generator for scalar transmission measurements

Spectrum analyzers

Easy virtual control¹⁾: control it your way, be it wired or wirelessly

Wireless remote control with R&S®MobileView app



Wired/wireless remote control with R&S®InstrumentView PC software



Flexible remote control on demand, anywhere, anytime.

¹⁾ Via a wireless router connected to the instrument's LAN port.

R&S®FPL1000 Spectrum Analyzer



Easy to carry with benchtop performance

The R&S®FPL1000 spectrum analyzer combines excellent RF performance with a small footprint. The light weight and optional battery/DC power make it the ideal instrument for the lab and in the field.

Operating the multi-touch display instrument is intuitive and fun to use. The R&S®FPL1000 supports multiple tasks in one instrument at an attractive price.

Model overview

Model	Frequency range	DANL at 1 GHz	Phase noise (f = 1 GHz, 10 kHz offset)	TOI at 1 GHz	Spurious response	Battery operation
R&S®FPL1003	5 kHz to 3 GHz	-166 dBm (typ.)	-108 dBc (1 Hz) (typ.)	+20 dBm (typ.)	< -70 dBc (typ.)	optional
R&S®FPL1007	5 kHz to 7.5 GHz					
R&S®FPL1014	5 kHz to 14 GHz					
R&S®FPL1026	5 kHz to 26.5 GHz					

Important facts

Specification	R&S®FPL1000	Why this is important
Analysis bandwidth	▶ 10 MHz standard ▶ 40 MHz optional	Digital demodulation possible within the analysis bandwidth.
Spurious	< -70 dBc	Unambiguous detection of small signals.
Phase noise (f = 1 GHz, 10 kHz offset)	< -105 dBc (1 Hz)	Analysis close to the carrier or of narrowband signals.
TOI at 1 GHz	> 17 dBm	Higher dynamic range to detect small signals in the presence of strong ones.
Dimensions (W x H x D)	408 mm x 186 mm x 235 mm	Smaller dimensions leave more space on the workbench and make it easier to integrate into a rack.
Weight	6 kg	Low weight for enhanced portability.
Battery operation	optional	Full portability.

Recommended options/accessories

Description	Type
OCXO frequency reference	R&S®FPL1-B4
Additional interfaces	R&S®FPL1-B5
Internal generator up to 3 GHz/7.5 GHz for R&S®FPL1003/R&S®FPL1007 (factory fitted)	R&S®FPL1-B9
IEEE-488 (GPIB) interface	R&S®FPL1-B10
YIG preselector bypass	R&S®FPL1-B11
Second hard disk (SSD)	R&S®FPL1-B19
RF preamplifier up to 7.5/14/26.5 GHz	R&S®FPL1-B22
1 dB steps for electronic attenuator	R&S®FPL1-B25
DC power supply, 12 V/24 V	R&S®FPL1-B30
Internal lithium-ion battery with charging unit	R&S®FPL1-B31
40 MHz analysis bandwidth	R&S®FPL1-B40

Recommended options/accessories

Description	Type
AM/FM/φM measurement demodulator	R&S®FPL1-K7
Power sensor measurement with R&S®NRP-Zxx power sensors	R&S®FPL1-K9
Noise figure measurement application	R&S®FPL1-K30
Phase noise measurement application	R&S®FPL1-K40
EMI measurement application	R&S®FPL1-K54
Vector signal analysis	R&S®FPL1-K70
Multi-modulation analysis ¹⁾	R&S®FPL1-K70M
BER measurements with PRBS data ¹⁾	R&S®FPL1-K70P

¹⁾ Requires R&S®FPL1-K70.



The perfect choice for:	
Research, education, service and maintenance	General purpose signal analysis and demodulation
Fast and easy integration into automated tests	Basic function test and EMI debugging in R&D

Your benefit	Features
One instrument for multiple tasks	<ul style="list-style-type: none"> ▶ Spectrum analysis ▶ Power meter ▶ Analog and digital signal analysis
More space on your test bench	▶ Smallest footprint in its class (depth of only 23.5 cm)
Take it with you everywhere	<ul style="list-style-type: none"> ▶ Top handle and low weight ▶ Optional battery pack, over 3 h operation ▶ Optional 12 V/24 V DC power supply

Up to 40% more space on your desk

The R&S®FPL1000 leaves up to 40% more space on a typical 80 cm workbench than comparable analyzers. With 60% less weight than comparable analyzers, it is the most portable benchtop analyzer.

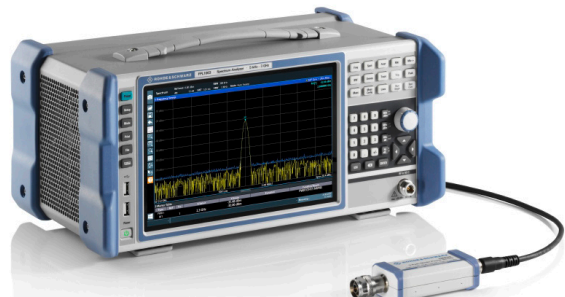
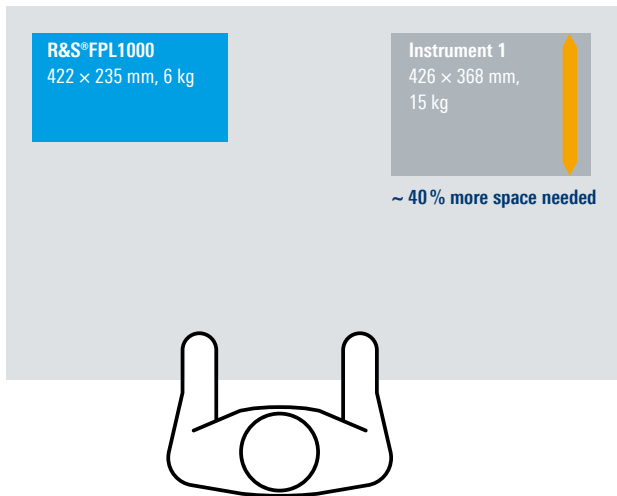

Use as a power meter: Turn the R&S®FPL1000 into a power meter with R&S®NRP power sensors and the R&S®FPL1-K9 option

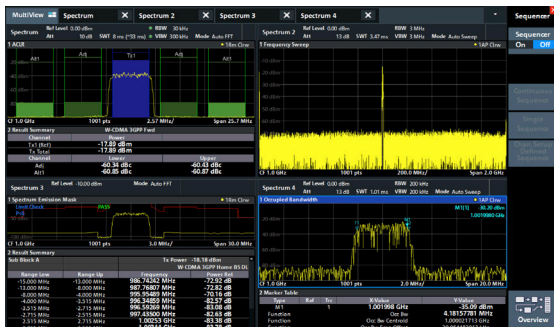

Flexible user interface: Configure your result windows the way you want. Display different measurement channels at once. Sequential channel updating allows parallel measurement of e.g. spectrum, spectrogram, I/Q analysis and analog demodulation.

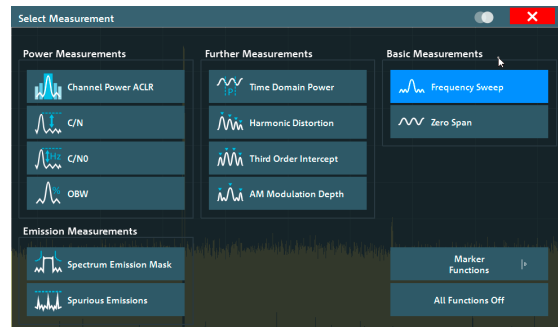

Many predefined measurements: Fast and easy access to a wealth of measurement and marker functions in the base model, including spectrogram measurements and I/Q analysis. Quick configuration through clear menus and touchscreen operation.

Spectrum analyzers

VECTOR NETWORK ANALYZERS

A vector network analyzer (VNA) reveals the response of an electrical network. A VNA includes at least one source to stimulate the device under test (DUT) in the forward and/or reverse direction, typically with frequency or continuous wave (CW) at a certain power, or power sweep at a certain frequency. Its receivers measure the signals that are reflected by or transmitted through the DUT. S-parameters are the most commonly used parameters in VNAs. They are calculated as the ratio between response and stimulus signals and provide information about the DUT characteristics, such as filter rejection and transmission, amplifier gain, cable attenuation and network matching.

Frequency range

The frequency range of a VNA is defined as its minimum and maximum settable frequency values. This is important as it needs to cover the frequency range of the DUT.

Sometimes a value for overrange is given, which allows a wider frequency range than officially specified. The measurement can be configured, but the operator must be aware that there is no performance data specified for the overrange and there might not be a matching calibration kit.

Rule of thumb: The frequency range of a VNA has to match the DUT's requirements.

Dynamic range

Also, the higher the dynamic range, the faster it is possible to measure through the use of wider IFBW. The dynamic range is defined as the difference between the max. source power and the noise floor of the instrument. For the specification of the dynamic range, typically a noise floor at 10 Hz IF bandwidth (IFBW) is used. By selecting a wider IFBW, an engineer can perform faster measurements at the cost of the dynamic range due to the increased noise floor. If the IF bandwidth is increased by a factor of 10, the dynamic range is reduced by approximately 10 dB.

Rule of thumb: Especially for DUTs with very high frequency blocking characteristics, it is important to have a low noise floor so that even signals with higher attenuation can be discerned from the unwanted noise. For accurate measurements, the signal-to-noise ratio (SNR) should be at least 20 dB.

Measurement speed

The measurement speed tells you how fast a measurement can be performed. This is especially critical for production environments, but is also interesting in a laboratory environment.

In general, the measurement speed is mainly determined by the number of measurement points, the IF bandwidth, whether calibration and/or offset are active and what type of calibration is used. If you have a low number of points, a high IF bandwidth and offset and calibration are inactive, the total sweep time can be in the range of milliseconds.

On the contrary, if you have a measurement setup with many channels and traces, a high number of measurement points, a narrow IF bandwidth and active calibration, the total test time can take several minutes.

Rule of thumb: One quick way to decrease the test time for one channel with one trace is to increase the IF bandwidth or reduce the number of points.

Approx. $t_{\text{Test}} \approx \text{number of points} / \text{IFBW}$

Passive and active components

It is important to choose the right VNA for measurement of the DUT depending on the required performance and test functions.

If passive components such as filters, cables and attenuators need to be measured, the VNA only needs to be able to perform standard S-parameter measurements and time-domain measurements, for example to know where a cable might be broken. For a simple filter with a high-blocking stopband, you might just need to measure its reflection (S_{11} and S_{22}) or its transmission (S_{21} and S_{12}) S-parameters. However, you still require a high dynamic range to characterize it precisely in its stopband range.

If active components need to be measured, you need to analyze the required test parameters even more carefully to find the appropriate VNA. If you want to measure the compression point of an amplifier, for example, you will need to be able to perform a power sweep and a power calibration, which is not a standard feature in all VNAs.

Type	Designation	Page
R&S®ZNL	Vector network analyzer	75
R&S®ZNLE	Vector network analyzer	77

Vector network analyzer portfolio

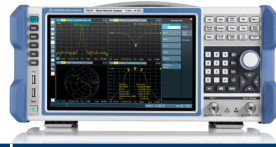

	R&S®ZNL	R&S®ZNLE
Frequency range	5 kHz to 20 GHz	100 kHz to 20 GHz
Overrange	–	–
Ports	two N(f) 50 Ω	two N(f) 50 Ω
Test set	bidirectional (S_{11} , S_{12} , S_{21} , S_{22})	bidirectional (S_{11} , S_{12} , S_{21} , S_{22})
Dynamic range	▶ up to 120 dB (spec.) ▶ up to 130 dB (typ.)	▶ up to 110 dB (spec.) ▶ up to 120 dB (typ.)
Number of points	1 to 100001	1 to 5001
IF bandwidth	1 Hz to 500 kHz	1 Hz to 500 kHz
Trace noise	▶ 0.0035 dB (RMS) (spec.) ▶ 0.0005 dB (RMS) (typ.)	▶ 0.005 dB (RMS) (spec.) ▶ 0.001 dB (RMS) (typ.)
Measurement speed (201 points, 100 kHz IF bandwidth, 200 MHz span, two-port calibration)	9.6 ms	9.6 ms
Maximum power	▶ 0 dBm (spec.) ▶ +3 dBm (typ.)	0 dBm
Minimum power	▶ –10 dBm (base unit) ▶ –40 dBm (with R&S®ZNLx-B22)	–10 dBm
Power sweep range	–	–
Power sensor support	available in spectrum analyzer mode	–
Display	25.6 cm (10.1") diagonal WXGA color LCD with touchscreen, 1280 × 800 pixel	25.6 cm (10.1") diagonal WXGA color LCD with touchscreen, 1280 × 800 pixel
Dimensions (W × H × D)	408 mm × 186 mm × 235 mm	408 mm × 186 mm × 235 mm
Weight	6 kg to 8 kg	6 kg
Calibration unit support	●	●
User port	–	–
GPIO interface	○	○
Handler I/O interface	–	–
Time domain	●	–
Distance to fault	●	–
Spectrum analysis	○	–
Power range extension	○	–

● available/yes

– not available/no

○ optional



R&S®ZNL Vector Network Analyzer



One device for all your measurements

Measurement equipment for RF applications must fulfill high quality standards. Instruments should be easy to use and offer high versatility. Fast measurements and reliable performance are crucial.

With the R&S®ZNL, Rohde&Schwarz exceeds these expectations and offers even more: Vector network analysis, spectrum analysis and power meter measurements are unified in a single, compact instrument, making the R&S®ZNL a universal allrounder.

Model overview

Model	Frequency range	Dynamic range	Output power	IF bandwidth	Measurement speed
R&S®ZNL3	5 kHz to 3 GHz	120 dB (spec.), 130 dB (typ.)	-40 dBm to 0 dBm (spec.)	1 Hz to 500 kHz	16.7 ms for 401 points (100 kHz IFBW, TOSM, 200 MHz span)
R&S®ZNL4	5 kHz to 4.5 GHz				
R&S®ZNL6	5 kHz to 6 GHz				
R&S®ZNL14	5 kHz to 14 GHz				
R&S®ZNL20	5 kHz to 20 GHz				

Important facts

Specification	R&S®ZNL	Why this is important
Frequency	5 kHz to 20 GHz	The measuring instrument has to cover the working frequency range of the DUT.
Dynamic range	120 dB (spec.), 130 dB (typ.)	A high dynamic range is important for measuring e.g. high-rejection filters. It also makes it possible to use a larger IF filter for faster measurement speed.
Output power	-40 dBm to 0 dBm (spec.)	A high output power is needed if you need to measure high-rejection filters (requires more dynamic range) or very long cables.
Speed	16.7 ms for 401 points (100 kHz IFBW, TOSM, 200 MHz span)	Especially in production environments, it is important to measure fast. Because time is money.
Display	•	Having an integrated monitor reduces hassle when configuring measurements.
External PC	not required	The R&S®ZNL just needs to be switched on, and users can start measuring without having to configure an external PC.
Dimensions (W x H x D)	408 mm x 186 mm x 235 mm	The size of the VNA determines how much space is left on the workbench for the measurement setup. It is usually better to have more space.
Weight	6 kg to 8 kg	If the instrument needs to be moved around, it is better to have a lighter instrument.

Scope of delivery

- ▶ Printed operating manual
- ▶ CD with manual
- ▶ Power cable
- ▶ 3 year warranty (one year for battery and accessories)

Recommended options/accessories

Description	Type
Vector network analyzer, 5 kHz to 3 GHz	R&S®ZNL3
Vector network analyzer, 5 kHz to 4.5 GHz	R&S®ZNL4
Vector network analyzer, 5 kHz to 6 GHz	R&S®ZNL6
Vector network analyzer, 5 kHz to 14 GHz	R&S®ZNL14
Vector network analyzer, 5 kHz to 20 GHz	R&S®ZNL20

Recommended options/accessories

Description	Type
Spectrum analyzer function	R&S®ZNLx-B1
Time domain analysis	R&S®ZNL-K2
Distance-to-fault measurements	R&S®ZNL-K3
Independent CW source ¹⁾	R&S®ZNL-K14
AM/FM/φM analog modulation analysis ¹⁾	R&S®FPL1-K7
Measurements with R&S®NRP power sensors ¹⁾	R&S®FPL1-K9

For more information about the R&S®VSE vector signal explorer software and selected options, contact your local Rohde&Schwarz sales office.

¹⁾ Requires R&S®ZNLx-B1 hardware option.



The perfect choice for:	
General purpose RF lab measurements	Low-cost volume manufacturing
Education and training	IoT and wireless manufacturing and troubleshooting

Highlights

- ▶ Widest frequency range from 5 kHz to 20 GHz
- ▶ 3 instruments in 1: vector network analyzer, spectrum analyzer and power meter
- ▶ Optional independent CW signal generator for spectrum analysis
- ▶ Two-port vector network analyzer for bidirectional measurements
- ▶ MultiView operation
- ▶ Wide dynamic range of up to 130 dB (typ.)
- ▶ Output power: from -40 dBm to 3 dBm (typ.)
- ▶ Fast measurements, e.g. 16.7 ms at 100 kHz IFBW (401 points, 200 MHz span, two-port calibration)
- ▶ Compact size and low weight (6 kg to 8 kg)
- ▶ Optional battery pack



MultiView provides a convenient overview of all active R&S®ZNL modes. The figure shows a combination of spectrum analyzer and network analyzer. In this view, all modes can be updated sequentially.

Portable for use on the go: With batteries, the R&S®ZNL can be used outside the labs. Batteries are hot-swappable.



Your benefit	Features
3 instruments in 1, plus an independent CW signal generator	A full two-port VNA that supports true spectrum analyzer hardware (R&S®ZNLx-B1) as well as power sensors (optional), turning it into a power meter. The R&S®ZNL with the R&S®ZNLx-B1 option can also benefit from the R&S®ZNL-K14 option, which allows the stimulation of a DUT by an independent continuous wave generator for analysis in the frequency spectrum domain
Widest frequency range in the market	The R&S®ZNL has an unrivaled frequency operation range. The start frequency at 5 kHz is the lowest in the market for VNAs ranging up to 20 GHz
Fully portable	The R&S®ZNL is very lightweight (6 kg to 8 kg) and very compact (408 mm x 235 mm footprint) and has a top handle for easy transport. The battery pack allows it to be used on the go
Clearly structured user interface with multi-touch	Wide capacitive touchscreen for convenient configuration with multi-touch gesturing. Undo/redo softkeys and fully integrated context-sensitive help menu for user-friendly operation
Compatible with R&S®VSE	The R&S®ZNL is fully compatible with the R&S®VSE vector signal explorer software and selected options for in-depth analysis of the device under test

Compact, lightweight instrument

The R&S®ZNL saves up to 67% of desk space, leaving plenty of room for the measurement setup.

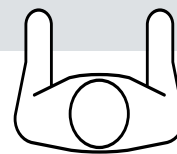
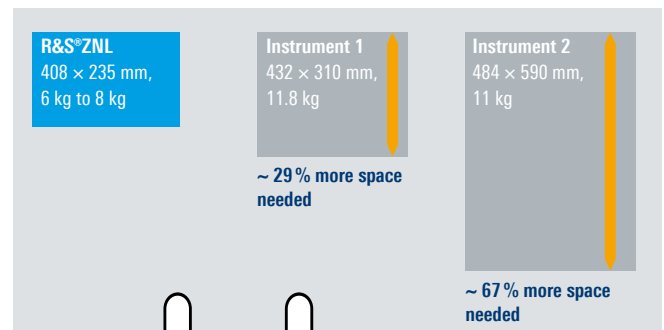

A padded soft carrying bag for safe transportation of the R&S®ZNL.



R&S®ZNLE Vector Network Analyzer



Vector network analysis made easy

With the R&S®ZNLE, vector network analysis measurements are as easy as ABC: easy to use, easy to calibrate, easy to configure.

Fast measurement speeds, reliable RF performance and a clearly structured user interface make the R&S®ZNLE the perfect choice for vector network analysis measurements on passive components.

Model overview

Model	Frequency range	Dynamic range	Output power	IF bandwidth	Measurement speed
R&S®ZNLE3	100 kHz ¹⁾ to 3 GHz	110 dB (spec.), 120 dB (typ.)	0 dBm	1 Hz to 500 kHz	16.7 ms for 401 points (100 kHz IFBW, TOSM, 200 MHz span)
R&S®ZNLE4	100 kHz ¹⁾ to 4.5 GHz				
R&S®ZNLE6	100 kHz ¹⁾ to 6 GHz				
R&S®ZNLE14	100 kHz ¹⁾ to 14 GHz				
R&S®ZNLE18	100 kHz ¹⁾ to 18 GHz ²⁾				

¹⁾ With R&S®ZNLE-B100 option.

²⁾ 20 GHz overrange.

Important facts

Specification	R&S®ZNLE	Why this is important
Frequency	100 kHz to 20 GHz	The measuring instrument has to cover the working frequency range of the DUT.
Dynamic range	110 dB (spec.), 120 dB (typ.)	A high dynamic range is important for measuring e.g. high-rejection filters. It also makes it possible to use a larger IF filter for faster measurements.
Output power	up to 0 dBm	High output power is required when measuring high-rejection filters (requires more dynamic range) or very long cables.
Speed	16.7 ms for 401 points (100 kHz IFBW, TOSM, 200 MHz span)	Especially in production environments, measurements need to be fast. Because time is money.
Display	•	An integrated monitor reduces hassle when configuring measurements.
External PC	not required	The R&S®ZNLE just needs to be switched on, and users can start measuring without having to configure an external PC.
Dimensions (W x H x D)	408 mm x 186 mm x 235 mm	VNA size determines how much space is left on the workbench for the measurement setup. It is usually better to have more space.
Weight	6 kg	If the instrument needs to be moved, a lighter instrument is better.



R&S®ZN-ZE1x calibration units can be used with the R&S®ZNLE to conveniently and quickly perform system error correction.

Scope of delivery

- ▶ Power cable
- ▶ Operating manual
- ▶ CD with manual
- ▶ 3 year warranty

Recommended options/accessories

Description	Type
Vector network analyzer, 1 MHz to 3 GHz	R&S®ZNLE3
Vector network analyzer, 1 MHz to 4.5 GHz	R&S®ZNLE4
Vector network analyzer, 1 MHz to 6 GHz	R&S®ZNLE6
Vector network analyzer, 1 MHz to 14 GHz	R&S®ZNLE14
Vector network analyzer, 1 MHz to 18 GHz ²⁾	R&S®ZNLE18
Extended frequency range, lower end, 1 MHz to 100 kHz	R&S®ZNLE-B100
Time domain analysis	R&S®ZNL-K2
Distance-to-fault measurements	R&S®ZNL-K3
GPIB interface	R&S®FPL1-B10



The perfect choice for:	
Passive RF components tests	Education and training
Automated testing	Production environment

Your benefit	Features
Solid performance in an economic instrument	Standalone vector network analyzer with fast measurement speed and low trace noise
Clearly structured user interface with multi-touch display	Wide capacitive touchscreen for convenient configuration with multi-touch gesturing. Undo/redo softkeys and fully integrated context-sensitive help menu for user-friendly operation
Standard instrument for use in the lab	De/embedding, fixture compensation, support of automatic calibration units and remote control via LAN or IEEE-488 (GPIB)
Precise time-domain measurements	The broad frequency range from 100 kHz (with R&S®ZNLE-B100 option) to 20 GHz (overrange) makes the R&S®ZNLE ideal for measurements in the time domain, where spatial resolution is crucial

Highlights

- ▶ Broad frequency range: from 100 kHz to 20 GHz
- ▶ Time domain and distance-to-fault options for deeper analysis of filters and cables
- ▶ Compact standalone vector network analyzer with fully integrated PC
- ▶ Fast measurement speeds
- ▶ Innovative user interface and wide 10.1" multi-touch display
- ▶ Windows 10 operating system
- ▶ Support of calibration units

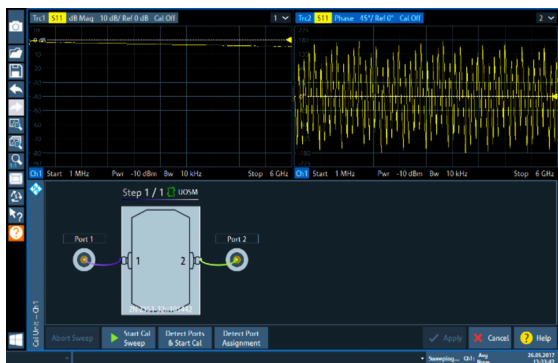

Automatic calibration units supported for convenient automatic system error correction. To be even quicker, one-step autocalibration is available.

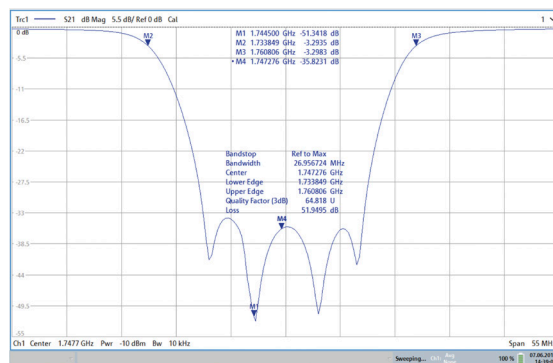

Vector network analysis: Automatic filter characterization with advanced marker functions – all important values in one step

Up to 67% more space on your desk

The R&S®ZNLE leaves up to 67% more space on a typical 80 cm workbench than comparable analyzers. Weighing 60% less than comparable analyzers, it is the most portable benchtop analyzer. The R&S®ZNLE fits easily on any desk for convenient everyday measurements such as tuning a filter.



R&S®ZNLE 408 × 235 mm, 6 kg	Instrument 1 432 × 310 mm, 11.8 kg	Instrument 2 484 × 590 mm, 11 kg
	~ 29% more space needed	~ 67% more space needed

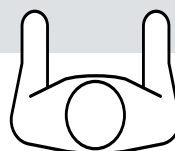

Vector network analyzers

METERS AND COUNTERS

What is an LCR bridge/meter?

An LCR bridge measures impedance parameters such as inductance, capacitance and resistance of an electronic component. Benchtop LCR meters typically have selectable test frequencies of more than 100 kHz to create data points at multiple spot frequencies. They often include options to superimpose a DC voltage or current on the AC measuring signal. In addition, benchtop meters allow the usage of special fixtures to measure surface mount device (SMD) components, air core coils and transformers. Often used in a general capacity, LCR bridges/meters can be used to validate and test development components during incoming inspection and to determine variations between parts. With fast measurements that shorten test times and binning interfaces to control a handler/sorter, LCR bridges/meters are also ideal for production facilities.

What is an arbitrary waveform generator?

An arbitrary waveform generator (AWG) generates electrical waveforms. It is usually used to test all aspects of a receive (RX) device to determine performance limits and unexpected behavior. AWGs can generate signals that closely approximate real-world signals, both wanted signals and interferers. The generated signals can be modified in precise ways to operate the receivers as usual or at performance limits.

Unlike function generators, AWGs can generate any arbitrarily defined waveform at their output. Some AWGs also operate as conventional function generators to produce standard waveforms such as sine, square, ramp, triangle, noise and pulse. Some units include additional built-in waveforms such as exponential rise and fall times, $\sin x/x$ and ECG. Some AWGs allow users to retrieve waveforms from a number of digital and mixed-signal oscilloscopes.

Type	Designation	Page
R&S®LCX	LCR meter	81

R&S®LCX LCR Meter



What sets this LCR meter apart?

- ▶ Fast, accurate and versatile
- ▶ Upgradeable frequency range
- ▶ Test signals for all requirements
- ▶ DC bias
- ▶ Data logging function
- ▶ High-resolution touchscreen
- ▶ Versatile test fixtures

Model overview

Model	Measurement functions	Frequency range	Test signal voltage (RMS)	Test signal current	Internal bias voltage
R&S®LCX100		DC, 4 Hz to 300 kHz	100 mV to 10 V	1 mA to 200 mA	
R&S®LCX200	Cp, Cs, Lp, Ls, D, Q, G, Rp, Rs, Rdc, R, X, Z, Y, θd, θr, B, M, N	DC, 4 Hz to 500 kHz (1 MHz or 10 MHz optional)	≤ 1 MHz: 100 mV to 10 V, ≤ 5 MHz: 100 mV to 2 V, > 5 MHz: 100 mV to 1 V	≤ 1 MHz: 1 mA to 100 mA, > 1 MHz to ≤ 5 MHz: 1 mA to 20 mA, > 5 MHz: 1 mA to 10 mA	0 V to 10 V

Important facts

Specification	R&S®LCX100, R&S®LCX200	Why this is important
Test fixtures	R&S®LCX-Z1, R&S®LCX-Z2, R&S®LCX-Z3, R&S®LCX-Z4, R&S®LCX-Z5, R&S®LCX-Z11	Versatile fixtures for lead-type devices, SMD components and transformers to perform measurements quickly.
Triggering	continuous, manual, or remote control via binning interface or trigger input	Accommodates more complex manufacturing setups.
Data logging	data rate up to 10 sample/s	Records all measured values every 100 ms.
Interfaces	standard: USB, LAN; optional: IEEE-488 (GPIB)	Most operations for an LCR meter are programmed. Having a modern and easy to use interface helps minimize input errors.

Scope of delivery

3 year warranty

Recommended options/accessories

Description	Type
LCR meter, 300 kHz, base unit	R&S®LCX100
LCR meter, 500 kHz, base unit	R&S®LCX200
Advanced analysis functions	R&S®LCX-K106
Digital I/O ports and binning function	R&S®LCX-K107
Extended bias functions	R&S®LCX-K108
Frequency upgrade to 1 MHz, for R&S®LCX200	R&S®LCX-K201
Frequency upgrade to 10 MHz, for R&S®LCX200	R&S®LCX-K210
IEEE-488 (GPIB) interface, for R&S®NGP/LCX	R&S®NG-B105
Test fixture for axial/radial lead type devices	R&S®LCX-Z1
Kelvin clip lead	R&S®LCX-Z2
Test fixture for SMD components	R&S®LCX-Z3
Test tweezers for SMD components	R&S®LCX-Z4
Transformer test cables	R&S®LCX-Z5
BNC extension, length: 1 m	R&S®LCX-Z11
19" rack adapter, 2 HU	R&S®ZZA-GE23



The perfect choice for:

Component R&D

Component production

Service and testing

Education

R&S®LCX-Z1



R&S®LCX-Z3



R&S®LCX-Z4



R&S®LCX-Z2



R&S®LCX-Z11



R&S®LCX-Z5



Test fixtures for a wide range of applications: LCR meters from Rohde & Schwarz can perform measurements on a wide range of components. Test fixtures are available that match the shape of the component.



Display and usability: Up to four measurement parameters can be shown on the display at the same time with additional information

Your benefit

Versatile functionality, all frequently used measurements supported

DC measurements and test signal frequencies of up to 10 MHz

Easy to use

Features

▶ Performs the full range of measurements required to characterize resistors, capacitors and inductors

▶ Frequency range from 4 Hz to 300 kHz
▶ Upper frequency limit of 500 kHz; extendable to 1 MHz or 10 MHz using software options

▶ Modern and intuitive operation thanks to a large capacitive touchscreen
▶ Frequently used functions directly accessible via the front panel keys

List of measurement functions

Cp	Capacitance value measured with parallel-equivalent circuit model
Cs	Capacitance value measured with series-equivalent circuit model
Lp	Inductance value measured with parallel-equivalent circuit model
Ls	Inductance value measured with series-equivalent circuit model
D	Dissipation factor
Q	Quality factor (inverse of D)
G	Equivalent parallel conductance measured with parallel-equivalent circuit model
Rp	Equivalent parallel resistance measured with parallel-equivalent circuit model
Rs	Equivalent series resistance measured with series-equivalent circuit model
Rdc	Direct current resistance
R	Resistance
X	Reactance
Z	Impedance
Y	Admittance
θd	Phase angle of impedance/admittance (degree)
θr	Phase angle of impedance/admittance (radian)
B	Susceptance
M	Mutual inductance
N	Turns ratio

Options for advanced applications

- ▶ **R&S®LCX-K106 advanced analysis functions**
For dynamic impedance measurements that sweep the frequency, voltage or current of the test signal or bias signal
- ▶ **R&S®LCX-K107 digital I/O ports and binning function**
Includes trigger input and eight data lines for binning
- ▶ **R&S®LCX-K108 extended bias functions**
External bias voltage of up to 40 V and internal bias source in current regulation mode of up to 200 mA
- ▶ **R&S®LCX-K201/-K210 frequency upgrade**
Upgrade to 1 MHz/10 MHz for the R&S®LCX200

You're in great hands.

YOU'RE IN GREAT HANDS.

Calibration you can trust



LONG-TERM BENEFITS: R&S®SERVICE CONTRACTS

LOW, PREDICTABLE COSTS

RELIABLE AND DEPENDABLE

TRANSPARENT AND FLEXIBLE

Rohde & Schwarz calibration versus third-party calibration

Two factors determine the quality of a calibration service:

- ▶ Compliance with relevant standards
- ▶ Coverage of technical parameters

A Rohde & Schwarz instrument has the technical capabilities and parameters to meet your needs. So, the calibration process has to cover all the technical parameters over the full performance range specified in the data sheet.

A review of calibration reports from third-party providers reveals that they do not always test all the relevant parameters.

This can lead to serious, unpredictable gaps in instrument performance.

Accredited calibrations require the scope of accreditation to cover every parameter.

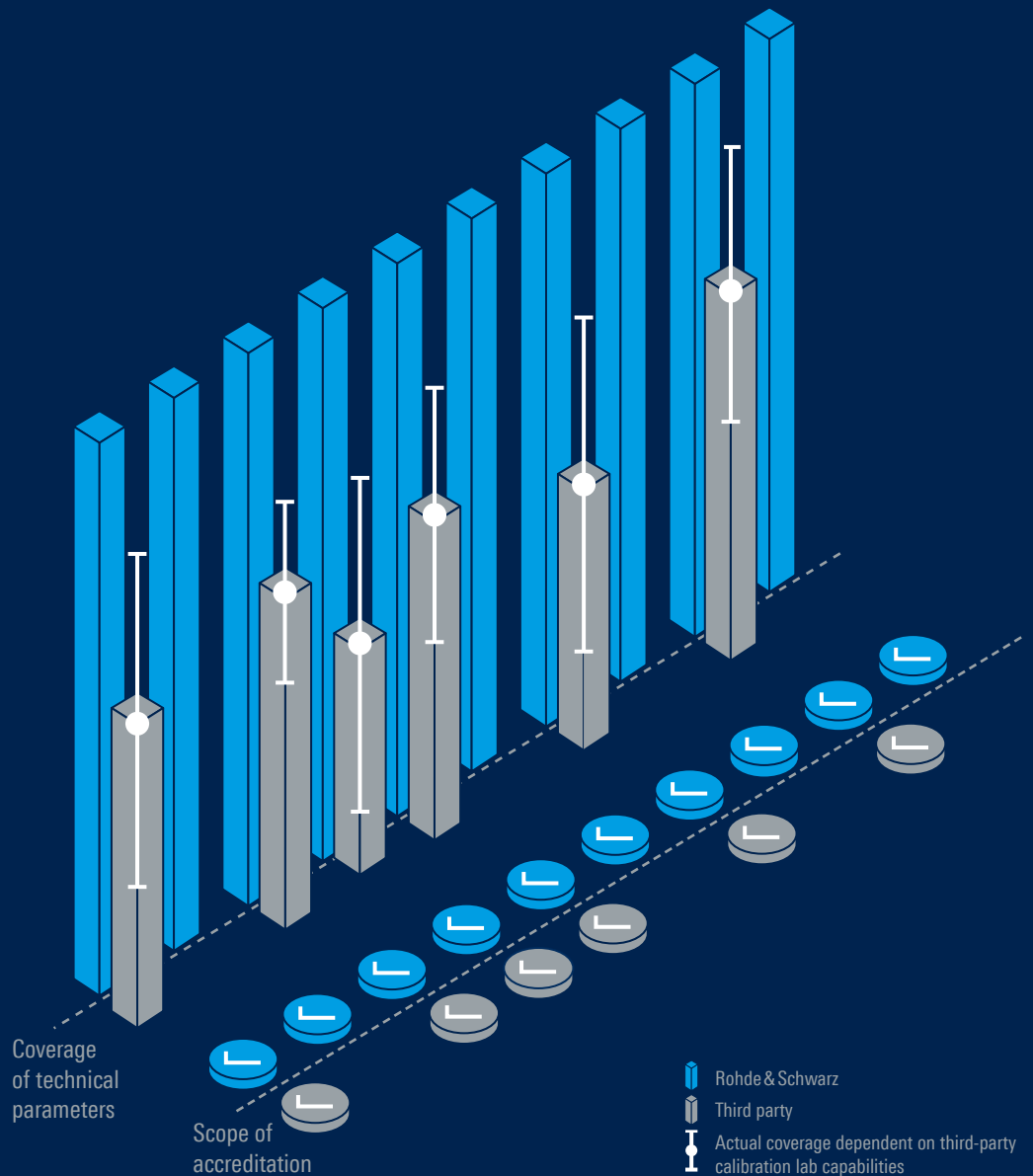

SERVICE

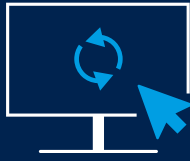

Rohde & Schwarz stands for innovative service products throughout the entire product lifecycle, supported by a global service network.

The following services are available in over 70 countries:

- ▶ Calibration
- ▶ Maintenance and repair
- ▶ Product updates and upgrades
- ▶ Remote service

Rohde & Schwarz regional service centers, plants and specialized subsidiaries provide a wide range of additional services for system customers:

- ▶ System integration
- ▶ Development of customized modules, equipment and systems
- ▶ Software development
- ▶ Installation and commissioning
- ▶ Application support

During the product's useful life, Rohde & Schwarz supports its customers with service level agreements in the following areas:

- ▶ System support
- ▶ Training
- ▶ Maintenance
- ▶ Spare parts service
- ▶ Integrated logistics support
- ▶ Obsolescence management
- ▶ Technical documentation



SERVICE AT ROHDE & SCHWARZ YOU'RE IN GREAT HANDS

- Worldwide
- Local and personalized
- Customized and flexible
- Uncompromising quality
- Long-term dependability



CONTACT INFORMATION

Rohde & Schwarz GmbH & Co. KG

www.rohde-schwarz.com

Corporate communications

Rohde & Schwarz GmbH & Co. KG
Corporate Communications
Mühldorfstraße 15
81671 Munich, Germany
Phone +49 89 4129 139 58
Fax +49 89 4129 135 63
press@rohde-schwarz.com

Sales

The addresses of the local sales companies can be found at: www.sales.rohde-schwarz.com

Rohde & Schwarz training

www.training.rohde-schwarz.com

Rohde & Schwarz customer support

Our customer support centers will be happy to answer any questions regarding our products and service:
www.rohde-schwarz.com/support



Plants

Memmingen plant

info.memmingen@rohde-schwarz.com

Teisnach plant

info.teisnach@rohde-schwarz.com

Vimperk plant

info.vimperk@rohde-schwarz.com

TRADEMARKS

Trade names are trademarks of the owners

- ▶ R&S® is a registered trademark of Rohde & Schwarz GmbH & Co. KG.
Example: R&S®FSC spectrum analyzer
- ▶ CDMA2000® is a registered trademark of the Telecommunications Industry Association (TIA-USA).
- ▶ LoRa® Mark and LoRa Logo are registered trademarks of Semtech Corporation.
- ▶ The Bluetooth® word mark and logos are registered trademarks owned by Bluetooth SIG, Inc. and any use of such marks by Rohde & Schwarz is under license.
- ▶ The terms HDMI, HDMI High-Definition Multimedia Interface, HDMI trade dress and the HDMI Logos are trademarks or registered trademarks of HDMI Licensing Administrator, Inc.
- ▶ Windows is a registered trademark of Microsoft Corp., USA
- ▶ “WiMAX”, “Mobile WiMAX”, “Fixed WiMAX”, “WiMAX Forum”, “WiMAX Certified”, “WiMAX Forum Certified”, “WiGRID”, the WiMAX Forum logo, the WiMAX Forum Certified logo and the WiGRID logo are trademarks or registered trademarks of the WiMAX Forum.

Published by

Rohde & Schwarz GmbH & Co. KG
Compilation, layout: Silke Knobloch, Department GF-BS1
Translation: Department GF-BS2

Rohde & Schwarz representative



R&S® is a registered trademark of Rohde & Schwarz GmbH & Co. KG
Trade names are trademarks of the owners
PD 3609.4361.42 | Version 12.00 | February 2023 (sk)
Subject to change

© 2012 - 2023
Rohde & Schwarz GmbH & Co. KG | 81671 Munich, Germany