

Agilent 87222C/D/E Coaxial Transfer Switches dc to 26.5, 40, 50 GHz

Technical Overview

High Performance Transfer Switches for Microwave and RF Instrumentation and Systems

- Exceptional repeatability for more than 5 million cycles
- Excellent isolation, typically > 90 dB at 26.5 GHz; > 60 dB at 40, 50 GHz
- Opto-electronic indicators and interrupts
- Magnetic latching
- TTL/5V CMOS compatible

Flexibility is essential in signal routing applications, and the Agilent Technologies 87222C/D/E 4-port coaxial transfer switches offer just that. They provide exceptional repeatability, low insertion loss, and high isolation. These switches provide simplification of design in signal routing and conditioning applications.

The 87222C/D/E can be used in a variety of applications, such as a drop-out switch, switching two inputs and two outputs, or signal reversal switching.

Description

Innovative design and careful process control mean the 87222C/D/E meet the requirements for highly repeatable switching elements in test instruments and switching interfaces. These switches are designed to operate for more than 10,000,000 cycles. They offer exceptional insertion loss repeatability, reducing sources of random errors in the measurement path and improving measurement uncertainty.

Switch life is a critical consideration in production test systems, satellite and antenna monitoring systems, and test instrumentation. The longevity of these switches increases system uptime and lowers the cost of ownership by reducing calibration cycles and switch maintenance.

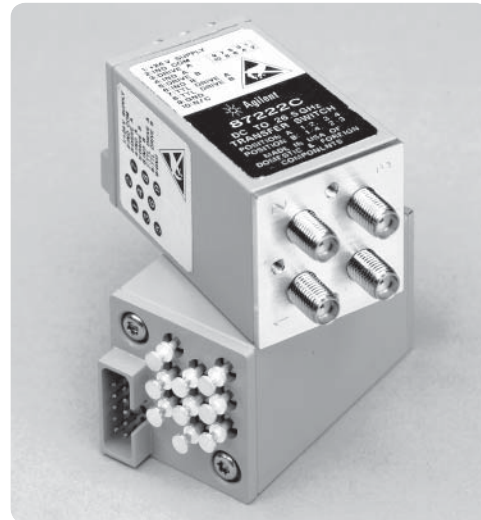

Microwave test accessories



Agilent Technologies

Operating from dc to 50 GHz, these switches exhibit exceptional isolation performance required to maintain measurement integrity. Isolation between ports is typically > 100 dB to 12 GHz, > 90 dB to 26.5 GHz, and > 60 dB to 50 GHz, reducing the influence of signals from other channels and system measurement uncertainties. Hence, the 87222C/D/E are ideal elements in large, multitiered switching systems.

The Agilent 87222C/D/E are designed to fall within most popular industry footprints. The 1¼ inch square flange provides tapped mounting holes, while the rest of the 2¾ inch long by 1¼ inch square body will easily fit into most

systems. The standard 10-pin ribbon drive cable or optional solder terminal connections accommodate the need for secure and efficient control cable attachment.

Opto-electronic interrupts and indicators improve reliability and extend the life of the switch by eliminating DC circuit contact failures characteristic of conventional electromechanical switches. The 87222C/D/E have circuits that interrupt the current to all the solenoids once switching is complete and offer independent indicators that are controlled by optical interrupts. These indicators provide a closed path between the indicator common pin and the corresponding sense pin of the selected path.

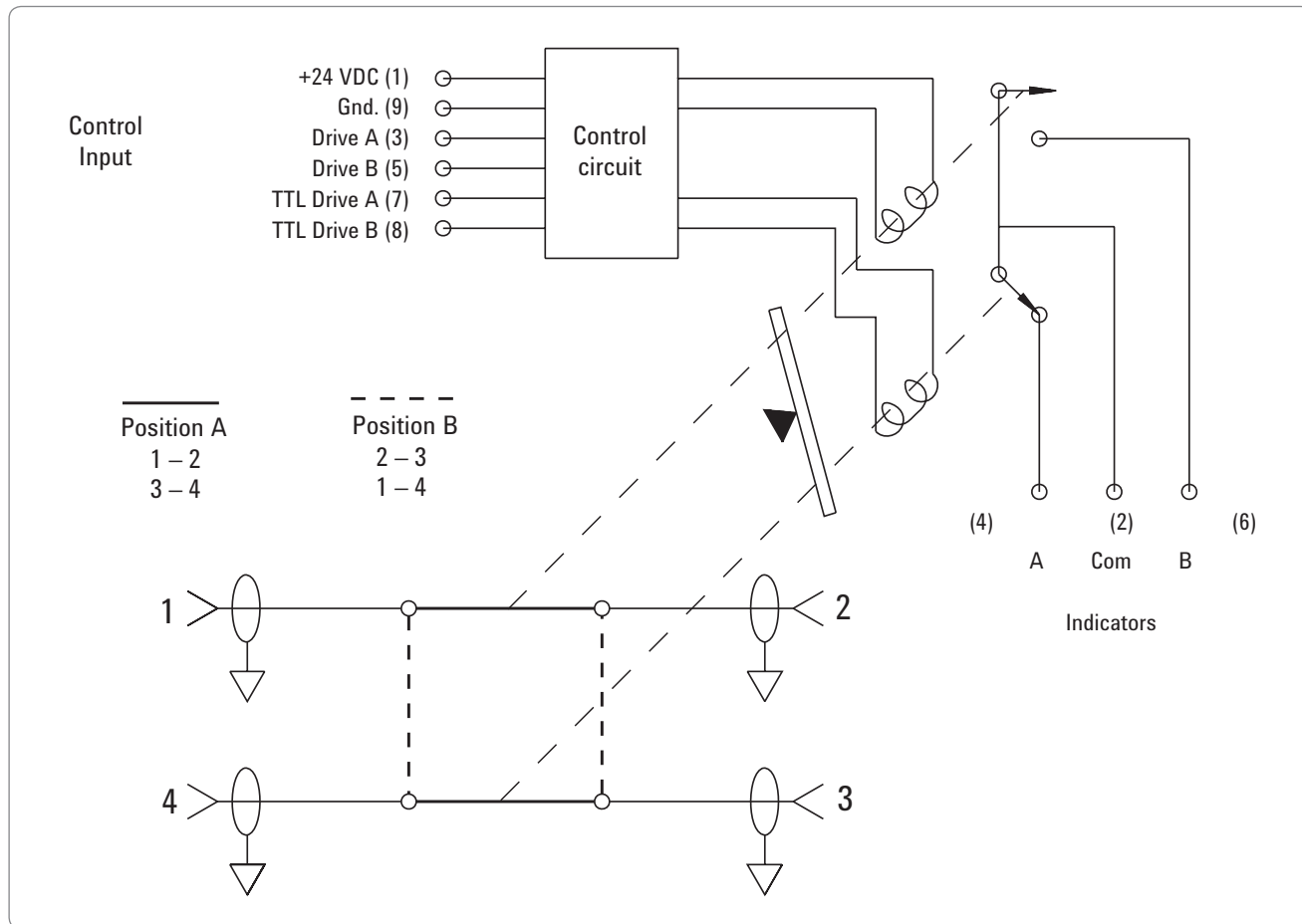

Figure 1. Agilent 87222C/D/E schematic

Applications

The Agilent 87222C/D/E transfer switches can be used in many different applications to increase system flexibility and simplify system design. The following are five examples: switch between two inputs and two outputs, use as a drop-out switch, use for signal reversal, configure as a SPDT switch, and bypass an active device.

The 87222C/D/E transfer switches have the ability to exchange two signals between two inputs and two outputs. Either transfer switch can connect two different instruments with two devices under test (DUT). Once switched, the signals are exchanged between the two instruments and the two DUTs. The exchanged signals allow complete network and spectrum analysis on two devices with a single switch and one test setup. See Figure 2 for an example of this application.

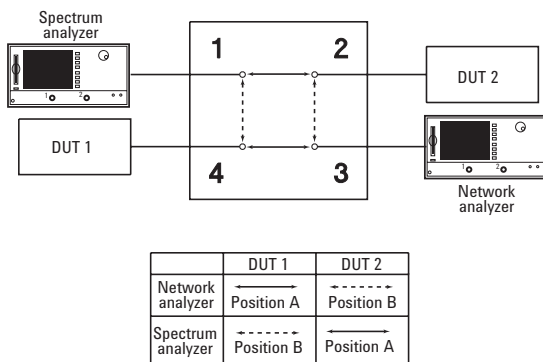

Figure 2. Switching two instruments and two DUTs

The 87222C/D/E can be used as a simple drop-out switch where a signal is either run through the device under test or straight through the switch, bypassing the device. See Figure 3.

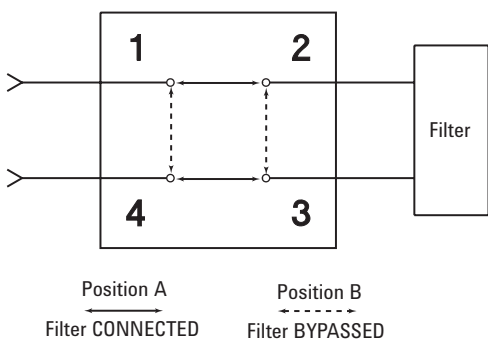

Figure 3. Drop-out switch

In the signal reverse configuration, a device can be connected across two diagonal ports of the 87222C/D/E transfer switch. This will allow the signal direction through the device to be reversed. See Figure 4.

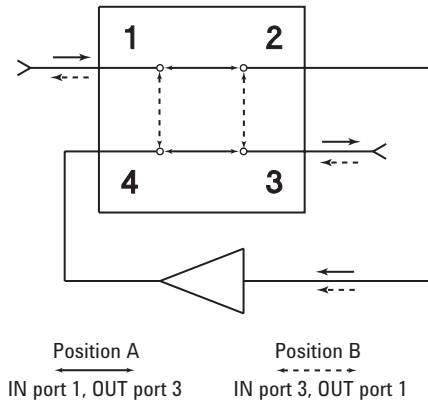

Figure 4. Signal reversal

By attaching an external termination, the designer can use the 87222C/D/E in a SPDT terminated switch configuration. See Figure 5.

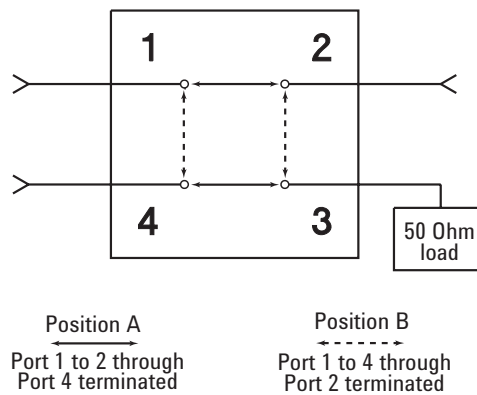

Figure 5. SPDT terminated

In Figure 6, an active device, such as an amplifier, is inserted into a signal path presenting a unique problem. A single transfer switch has the undesirable characteristic of shunting the output of the amplifier to its input when the signal is bypassing the amplifier. The advantage of using two transfer switches is that an additional signal path is available, however two SPDT switches can also be used. This additional path can utilize the same amplifier when the original path is bypassed.

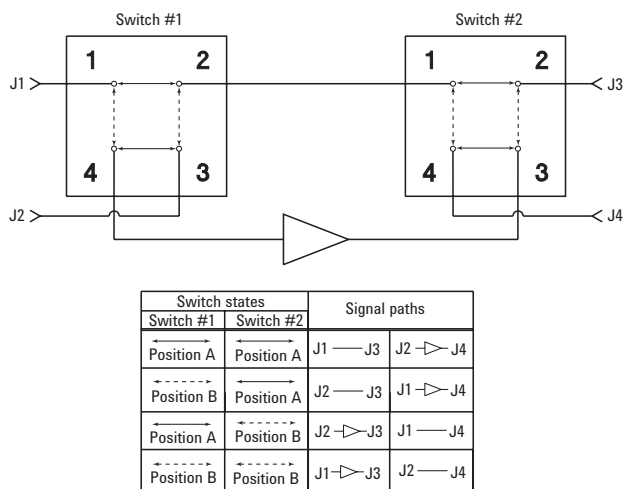

Figure 6. Bypassing an active device

Driving the switch

There are two positions for the 87222C/D/E transfer switches. See Table A. Position A has RF Port 1 connected to RF Port 2 and RF Port 3 connected to RF Port 4. Position B has RF Port 2 connected to RF Port 3 and RF Port 1 connected to RF Port 4. Either switch can be driven with a standard grounding drive control with or without a separate ground. Single line or Dual line TTL control are also available. The switch operates in a break-before-make mode. See Figure 7.

(I) Standard drive:

See Figure 8 for drive connection diagrams.

- Connect pin 1 to supply (+20 VDC to +32 VDC).
- Connect pin 9 to ground (see Note 1).
- Select position A by applying ground to pin 3 (see Note 3).
- Select position B by applying ground to pin 5 (see Note 3).

(II) Single line TTL drive:

See Figure 8 for drive connection diagrams.

See Figure 9 for TTL voltage states.

- Connect pin 1 to supply (+20 VDC to +32 VDC).
- Connect pin 9 to ground (see Notes 2, 4).
- Connect pin 8 to TTL "High."
- Select position A by applying TTL "High" to pin 7 (see Note 3).
- Select position B by applying TTL "Low" to pin 7 (see Note 3).

(III) Dual line TTL drive:

See Figure 8 for drive connection diagrams.

See Figure 9 for TTL voltage states.

- Connect pin 1 to supply (+20 VDC to +32 VDC).
- Connect pin 9 to ground (see Notes 2, 4).
- Select position A by applying TTL "High" to pin 7 and TTL "Low" to pin 8 (see Note 3).
- Select position B by applying TTL "Low" to pin 7 and TTL "High" to pin 8 (see Note 3).

Notes:

1. Pin 9 does not need to be grounded for the switch to operate in standard drive mode. If pin 9 is not grounded, the position indicators will only function while the appropriate drive has ground applied. Therefore, if a pulse drive is used and continuous indicator operation is required, pin 9 must be grounded.
2. For TTL drive, pin 9 must be grounded.
3. After the RF path is switched and latched, the drive current is interrupted by the electronic position-sensing circuitry. Pulsed control is not necessary, but if implemented, the pulse width must be 15 ms minimum to ensure that the switch is fully latched.
4. In addition to the quiescent current supplying the electronic position-sensing circuitry, the drive current flows out of pin 9 (during switching) when using TTL drive.

“CAUTION FOR USERS OF THE AGILENT 11713B/C SWITCH DRIVER: Do not drive the 87222C/D/E using the S9 or S0 outputs from either the banana plugs or from pins 3 or 4 within the Atten X and Atten Y Viking sockets located on the rear panel of the 11713B/C.”

Table A. Drive control alternatives

RF path	(I) Standard drive voltage		(II) Single line TTL/5V CMOS drive voltage		(III) Dual line TTL/5V CMOS drive voltage	
	Drive A Pin 3	Drive B Pin 5	TTL Drive A Pin 7	TTL Drive B Pin 8	TTL Drive A Pin 7	TTL Drive B Pin 8
Position A 1 to 2, 3 to 4	Ground	Open	High	High	High	Low
Position B 2 to 3, 1 to 4	Open	Ground	Low	High	Low	High

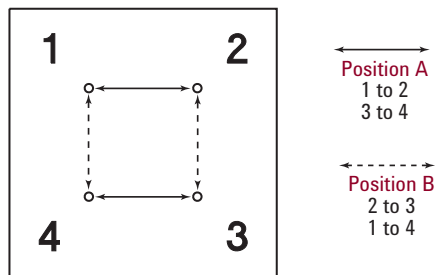

Figure 7. RF port connections

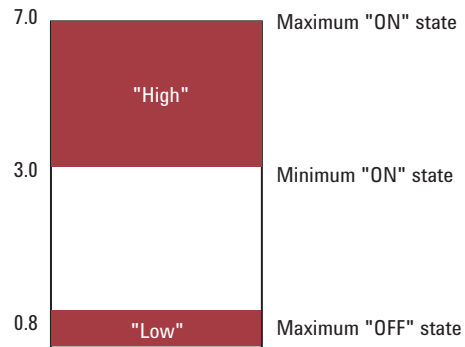

Figure 9. TTL control voltage states

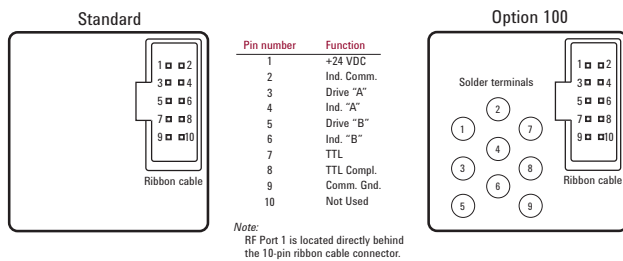

Figure 8. Drive connections

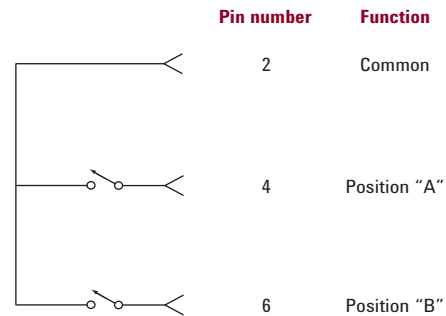

Figure 10. Indicator function diagram

Electronic position indicators

The independent electronic position indicators consist of optically isolated, solid-state relays, which are driven by photo-electric sensors coupled to the mechanical position of the RF path's moving elements. See Figure 10. The circuitry consists of a common which can be connected to an output corresponding to either position A or position B. The solid state relays are configured for AC and/or DC operation. (See indicator specifications.) The electronic position indicators require that the supply (+20 VDC to +32 VDC) be connected to pin 1 but requires that pin 9 be grounded if pulse drive is used and continuous indicators operation is desired. If pin 9 is not grounded, the position indicators will function while the appropriate drive has ground applied.

Specifications

Specifications describe the instrument's warranted performance. Supplemental and typical characteristics are intended to provide information useful in applying the instrument by giving typical, but not warranted performance parameters.

Table B. Standard switch drive specifications

Parameter	Conditions	Min	Nom	Max	Units
Supply voltage		20	24	32	V
Supply current, I_{cc}	Switching: Pulse width >15 ms: V _{cc} = 24 VDC		200		mA
Supply current (quiescent)		25		50	mA

Table C. TTL Specific drive specifications

Parameter	Conditions	Min	Nom	Max	Units
High level input		3		7	V
Low level input				0.8	V
Max high input current	V _{cc} = Max V input = 3.85 VDC		1	1.4	mA

General operating data

Nominal/Impedance	50 Ω
Maximum power rating	
Switching	1W CW
Non-switching	50W Pk (not to exceed 1 watt average)
Life	5,000,000 cycles minimum
Switching speed	15 ms maximum

Indicator specifications

Maximum withstand voltage	60 V
Maximum current capacity	100 mA
Maximum "ON" resistance	50 Ω
Minimum "OFF" resistance	1 G Ω

Environmental specifications

Operating temperature	-25 to 75 $^{\circ}\text{C}$
Storage temperature	-55 to 85 $^{\circ}\text{C}$
Temperature cycling	55 to 85 $^{\circ}\text{C}$, 10 cycles per MIL-STD-202F, Method 107D, Condition A (modified)

Vibration	
Operating	7 g, 5 to 2000 Hz at 0.25 inches pk-pk
Survival	20 g, 20 to 2000 Hz at 0.06 inches pk-pk, 4 min/cycle, 4 cycles/axis
Random	2.41 g (rms) 10 min/axis

Shock	
Half-sine	500 g at 0.5 ms, 3 drops/direction, 18 total

Operating	50 g at 6 ms, 6 directions
Moisture resistance	65 $^{\circ}\text{C}$, 95% RH, 10 days per MIL-STD-202F, Method 106E

Altitude storage	50,000 feet (15,240 meters per MIL-STD-202F, Method 105C, Condition B)
-------------------------	--

RFI	Per MIL-STD-461C, RE02, Part 4
------------	--------------------------------

Agilent 87222C

Frequency range	dc to 26.5 GHz
Insertion loss	0.2 dB + 0.025 x frequency (GHz)
Isolation	120 dB-2.0 x frequency (GHz)
SWR	1.1 maximum dc to 2 GHz 1.15 maximum 2 to 4 GHz 1.25 maximum 4 to 12.4 GHz 1.4 maximum 12.4 to 20 GHz 1.65 maximum 20 to 26.5 GHz
Insertion loss repeatability	< 0.03 dB typical
Connectors	SMA (f)

Agilent 87222D

Frequency range	dc to 40 GHz
Insertion loss	0.2 dB + 0.025 x frequency (GHz)
Isolation	DC-26.5 120 dB-2.0 x frequency (GHz) 26.5-40 60 dB
SWR	1.3 maximum dc to 12.4 GHz 1.4 maximum dc to 12.4 to 25 GHz 1.7 maximum dc to 25 to 40 GHz
Insertion loss repeatability	< 0.03 dB typical
Connectors	2.92 mm (f)

Agilent 87222E

Frequency range	dc to 50 GHz
Insertion loss	0.15 dB + 0.020 x frequency (GHz)
Isolation	DC-26.5 120 dB-2.0 x frequency (GHz) 26.5-50 60 dB
SWR	1.3 maximum dc to 12.4 GHz 1.4 maximum 12.4 to 20 GHz 1.5 maximum 20 to 30 GHz 1.6 maximum 30 to 40 GHz 1.7 maximum 40 to 50 GHz
Insertion loss repeatability	DC-40 GHz < 0.03 dB typical 40-50 GHz < 0.05 dB typical
Connectors	2.4 mm (f)

Agilent 87222C/D/E physical specifications

Dimensions	Per Figure 13
Weight	100 gm (0.23 lb)

Supplemental Characteristic

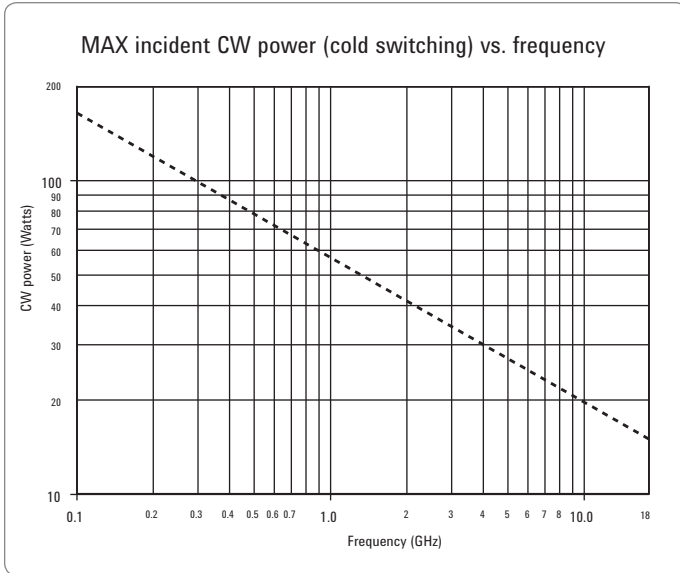

Reference conditions:

- Cold switching only (NO Hot switching)
- Ambient temperature of 75 °C or less
- Sea level (0.88 derating @ 15,000 ft.)
- Load VSWR < 1.2 (see graph for derating above 1.2 VSWR)
- Power Handling at 25 °C is 100 W at 4 GHz

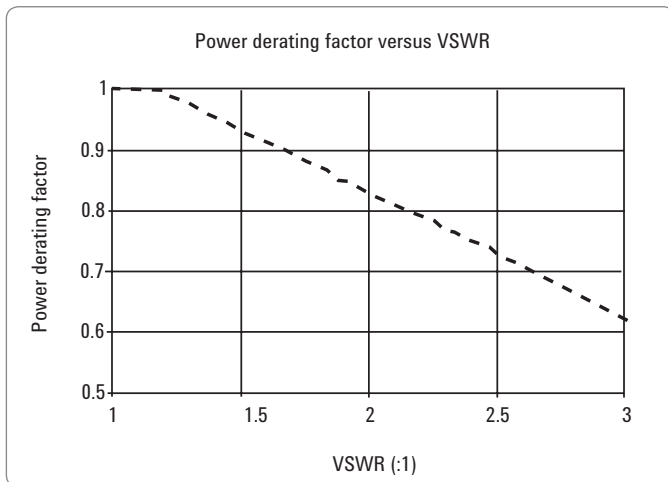

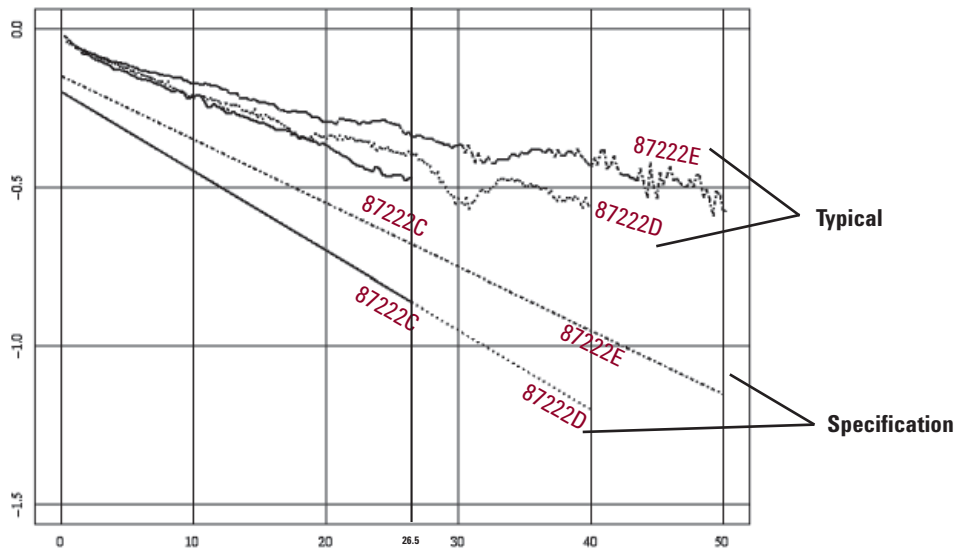

Figure 11. Agilent 87222C/D/E insertion loss versus frequency

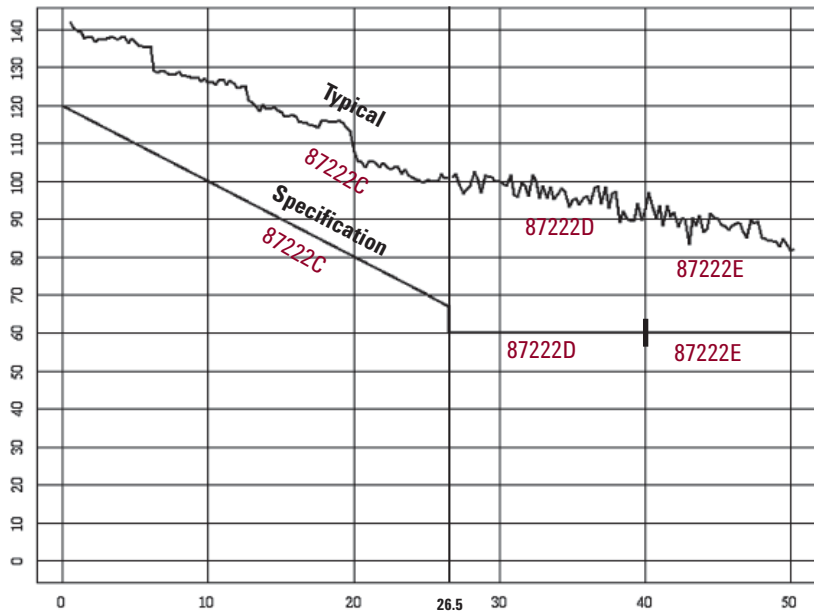

Figure 12. Agilent 87222C/D/E isolation versus frequency

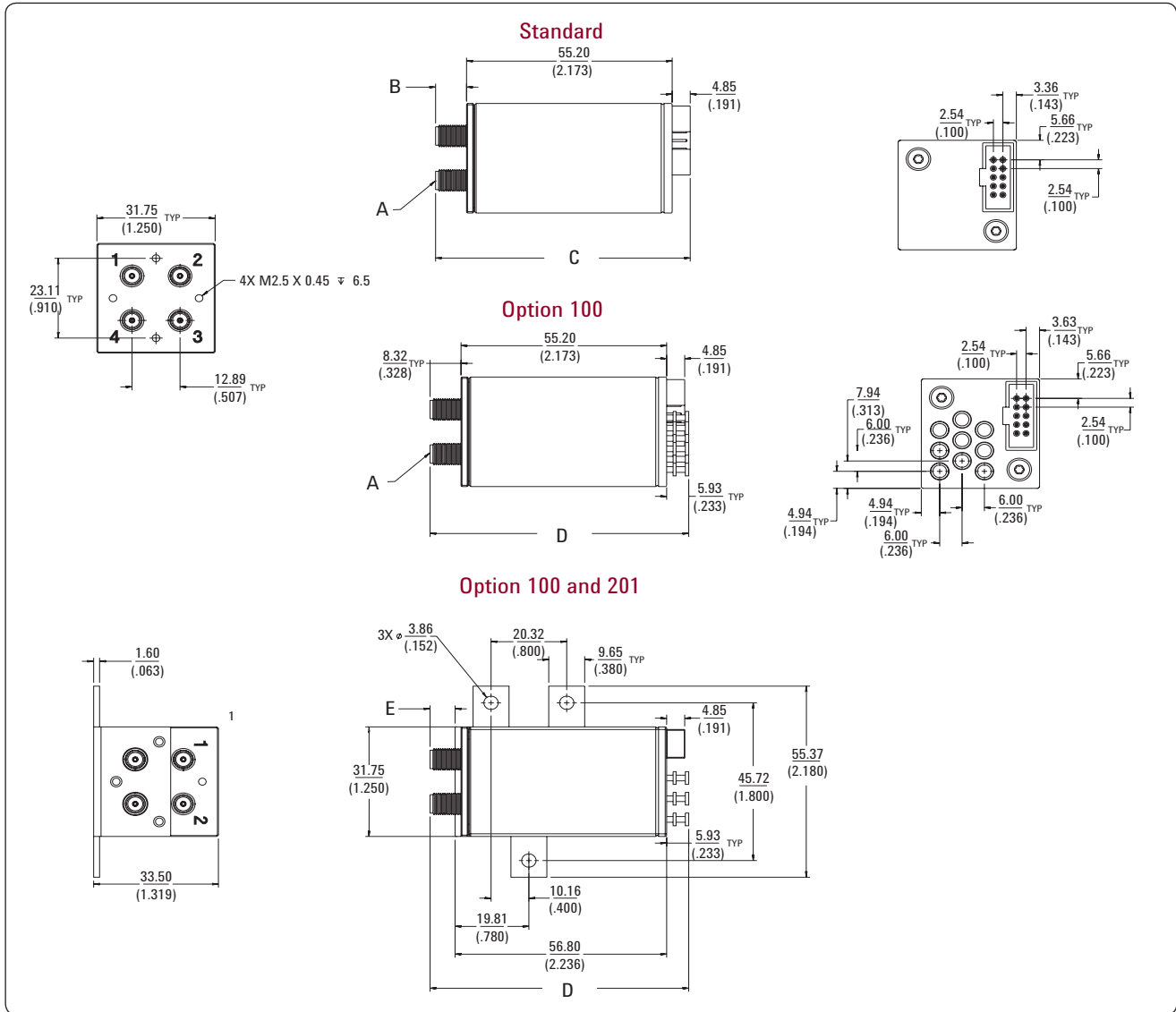

Figure 13. Product outlines

Note: Dimensions are in millimeter and (inches) nominal unless otherwise specified.

Agilent model number		A	B	C	D
87222C	millimeter (inches)	8.32 (.328) TYP	REF 68.37 (2.692)	REF 69.46 (2.735)	REF 6.72 (.265)
87222D	millimeter (inches)	8.32 (.328) TYP	REF 68.37 (2.692)	REF 69.46 (2.735)	REF 6.72 (.265)
87222E	millimeter (inches)	9.00 (.354) TYP	REF 69.05 (2.719)	REF 70.14 (2.761)	REF 7.40 (.291)

1. One of four bracket configurations shown.

Ordering Guide

Agilent Coaxial transfer switch

87222C dc to 26.5 GHz

87222D dc to 40 GHz

87222E dc to 50 GHz

Option 100 Solder terminals in addition to ribbon cable

Option 201 Mounting bracket-assembly required

Option UK6¹ Commercial calibration test data with certificate

Accessories available

87222-00003 Mounting bracket

Agilent drivers

11713B/C attenuator switch driver

Drives up to 10 switches.

Accessory cables

5061-0969 Viking connector to bare tinned wires (60 inches long). Use to connect 11713B/C to 87222C/D/E with Option 100. Will operate four 87222C/D/E switches.

11713-60047 Viking connector to (4) 4-pin DIP connectors. Will operate four 87222C/D/E switches using the 11713B/C driver.

Related Literature

1. *Agilent Technologies Bench and System Switching Products*, Literature Number 5989-9872EN
2. *Agilent RF and Microwave Switch, Selection Guide*, Literature Number 5989-6031EN
3. *Agilent 11713B/C Attenuator/Switch Drivers, Configuration Guide*, Literature Number 5989-7277EN

Application Notes:

Power Handling Capability of Electromechanical Switches, Literature Number 5989-6032EN

How Operating Life and Repeatability of Agilent's Electromechanical Switches Minimize System Uncertainty, Literature Number 5989-6085EN

1. Option UK6 not available with 87222D.



Agilent Email Updates

www.agilent.com/find/emailupdates
Get the latest information on the products and applications you select.



Agilent Direct

www.agilent.com/find/agilentdirect
Quickly choose and use your test equipment solutions with confidence.

Remove all doubt

Our repair and calibration services will get your equipment back to you, performing like new, when promised. You will get full value out of your Agilent equipment throughout its lifetime. Your equipment will be serviced by Agilent-trained technicians using the latest factory calibration procedures, automated repair diagnostics and genuine parts. You will always have the utmost confidence in your measurements. For information regarding self maintenance of this product, please contact your Agilent office.

Agilent offers a wide range of additional expert test and measurement services for your equipment, including initial start-up assistance, onsite education and training, as well as design, system integration, and project management.

For more information on repair and calibration services, go to:

www.agilent.com/find/removealldoubt

Product specifications and descriptions in this document subject to change without notice.

www.agilent.com
www.agilent.com/find/mta

For more information on Agilent Technologies' products, applications or services, please contact your local Agilent office. The complete list is available at:

www.agilent.com/find/contactus

Americas

Canada	(877) 894-4414
Latin America	305 269 7500
United States	(800) 829-4444

Asia Pacific

Australia	1 800 629 485
China	800 810 0189
Hong Kong	800 938 693
India	1 800 112 929
Japan	0120 (421) 345
Korea	080 769 0800
Malaysia	1 800 888 848
Singapore	1 800 375 8100
Taiwan	0800 047 866
Thailand	1 800 226 008

Europe & Middle East

Austria	01 36027 71571
Belgium	32 (0) 2 404 93 40
Denmark	45 70 13 15 15
Finland	358 (0) 10 855 2100
France	0825 010 700*
Germany	07031 464 6333
Ireland	1890 924 204
Israel	972-3-9288-504/544
Italy	39 02 92 60 8484
Netherlands	31 (0) 20 547 2111
Spain	34 (91) 631 3300
Sweden	0200-88 22 55
Switzerland	0800 80 53 53
United Kingdom	44 (0) 118 9276201

Other European Countries:

www.agilent.com/find/contactus

Revised: March 24, 2009

© Agilent Technologies, Inc. 2001, 2005, 2009
Printed in USA, June 30, 2009
5968-2216E



Agilent Technologies