



Product Change Notification / SYST-19IZMV013

Date:

23-Mar-2023

Product Category:

Bluetooth Module

PCN Type:

Document Change

Notification Subject:

Data Sheet - RN4020-Bluetooth® Low Energy Module Data Sheet

Affected CPNs:

[SYST-19IZMV013_Affected_CPN_03232023.pdf](#)

[SYST-19IZMV013_Affected_CPN_03232023.csv](#)

Notification Text:

SYST-19IZMV013

Microchip has released a new Datasheet for the RN4020-Bluetooth® Low Energy Module Data Sheet of devices. If you are using one of these devices please read the document located at [RN4020-Bluetooth® Low Energy Module Data Sheet](#).

Notification Status: Final

Description of Change:

This revision includes update to Bluetooth® version of the module.

Impacts to Data Sheet: See above details.

Reason for Change: To Improve Productivity

Change Implementation Status: Complete

Date Document Changes Effective: 23 Mar 2023

NOTE: Please be advised that this is a change to the document only the product has not been changed.

Markings to Distinguish Revised from Unrevised Devices::N/A

Attachments:

[RN4020-Bluetooth® Low Energy Module Data Sheet](#)

Please contact your local [Microchip sales office](#) with questions or concerns regarding this notification.

Terms and Conditions:

If you wish to receive Microchip PCNs via email please register for our PCN email service at our [PCN home page](#) select register then fill in the required fields. You will find instructions about registering for Microchips PCN email service in the [PCN FAQ](#) section.

If you wish to change your PCN profile, including opt out, please go to the [PCN home page](#) select login and sign into your myMicrochip account. Select a profile option from the left navigation bar and make the applicable selections.

Affected Catalog Part Numbers (CPN)

RN4020-V/RMBEC133

RN4020-V/RM

RN4020-V/RM120

RN4020BCN-V/RM120

RN4020-V/RM123

Bluetooth® Low Energy Module

Features

- Fully certified Bluetooth® version 4.0 module
- On-board Bluetooth Low Energy 4.0 stack
- ASCII command interface API over UART
- Device Firmware Upgrade (DFU) over UART or Over the Air (OTA)
- Microchip Low-energy Data Profile (MLDP) for serial data applications
- Remote commands over-the-air
- 64 KB internal flash
- Compact form factor: 11.5 mm x 19.5 mm x 2.5 mm
- Castellated SMT pads for easy and reliable PCB mounting
- Environmentally friendly, RoHS compliant
- Certifications: FCC, ISED, CE, QDID, VCCI, KCC and NCC

Operational

- Single operating voltage: 1.8V to 3.6V (3.3V typical)
- Temperature range: -30°C to 85°C
- Low-power consumption
- Simple, UART interface
- Integrated Crystal, I²C Interface, Internal Voltage Regulator, Matching Circuitry, and PCB Antenna
- Multiple IOs for control and status
- GPIO, ADC
- Three Pulse Width Modulation (PWM) outputs

RF/Analog Features

- ISM Band 2.402 to 2.480 GHz operation
- Channels 0-39
- RX Sensitivity: -92.5 dBm at 0.1% BER
- TX Power: -19.0 dBm to +7.5 dBm
- RSSI Monitor

MAC/Baseband/Higher Layer Features

- Secure AES128 encryption
- GAP, GATT, SM, L2CAP, and integrated public profiles
- Create custom services using command API
- Keyboard I/O Authentication
- Software configurable role as peripheral or central and client or server
- Built-in scripting capabilities for hostless operation



Applications

- Health/Medical Devices
 - Glucose meters
 - Heart rate
 - Scale
- Sports Activity and Fitness
 - Pedometer
 - Cycling computer
 - Heart rate
- Retail
 - Point of Sale (POS)
 - Asset tagging and tracking
 - Proximity advertising
- Beacon Applications
- Internet of Things (IoT) Sensor tag
- Remote Control
 - Embedded Device Control
 - AV consoles and game controllers
- Wearable Smart Devices and Accessories
- Industrial Control
 - Private (custom) services
 - Low bandwidth cable replacement
- Smart Energy/Smart Home

Description

Microchip's RN4020 Bluetooth Low Energy Module provides a highly integrated solution for delivering low-power Bluetooth 4.0 solutions. The advanced command interface offers rapid time to market. The RN4020 module complies with Bluetooth specification version 4.0. The module integrates RF, a baseband controller, and a command API processor, making it a complete Bluetooth Low Energy solution. The RN4020 can be used with ultra-low cost microcontroller for intelligent Bluetooth Low Energy applications. For simple sensor applications, the RN4020 internal scripting capabilities enable basic functions to be implemented without the need for external host MCU or software development tools.

Table of Contents

1.0	Device Overview	3
2.0	General Specifications	6
3.0	Microcontroller to RN4020 Interface	7
4.0	Physical Dimensions	8
5.0	Typical Application Schematic	11
6.0	ASCII Command API	12
7.0	Supported Services	13
8.0	Regulatory Approval	15
9.0	Ordering Information	21
Appendix A: Revision History		23
The Microchip Web Site		25
Customer Change Notification Service		25
Customer Support		25

TO OUR VALUED CUSTOMERS

It is our intention to provide our valued customers with the best documentation possible to ensure successful use of your Microchip products. To this end, we will continue to improve our publications to better suit your needs. Our publications will be refined and enhanced as new volumes and updates are introduced.

If you have any questions or comments regarding this publication, please contact the Marketing Communications Department via E-mail at docerrors@microchip.com. We welcome your feedback.

Most Current Data Sheet

To obtain the most up-to-date version of this data sheet, please register at our Worldwide Web site at:

<http://www.microchip.com>

You can determine the version of a data sheet by examining its literature number found on the bottom outside corner of any page. The last character of the literature number is the version number, (e.g., DS30000000A is version A of document DS30000000).

Errata

An errata sheet, describing minor operational differences from the data sheet and recommended workarounds, may exist for current devices. As device/documentation issues become known to us, we will publish an errata sheet. The errata will specify the revision of silicon and revision of document to which it applies.

To determine if an errata sheet exists for a particular device, please check with one of the following:

- Microchip's Worldwide Web site; <http://www.microchip.com>
- Your local Microchip sales office (see last page)

When contacting a sales office, please specify which device, revision of silicon and data sheet (include literature number) you are using.

Customer Notification System

Register on our web site at www.microchip.com to receive the most current information on all of our products.

1.0 DEVICE OVERVIEW

The RN4020 Bluetooth Low Energy RF module integrates Bluetooth 4.0 radio baseband, MCU, digital analog I/O, on-board stack, and ASCII command API. [Figure 1-1](#) shows the top view of the module. The pinout of the module is shown in [Figure 1-2](#), and the description is presented in [Table 1-1](#). [Figure 1-3](#) lists all the key components of the module.

FIGURE 1-1: RN4020 TOP VIEW



FIGURE 1-2: RN4020 PIN DIAGRAM

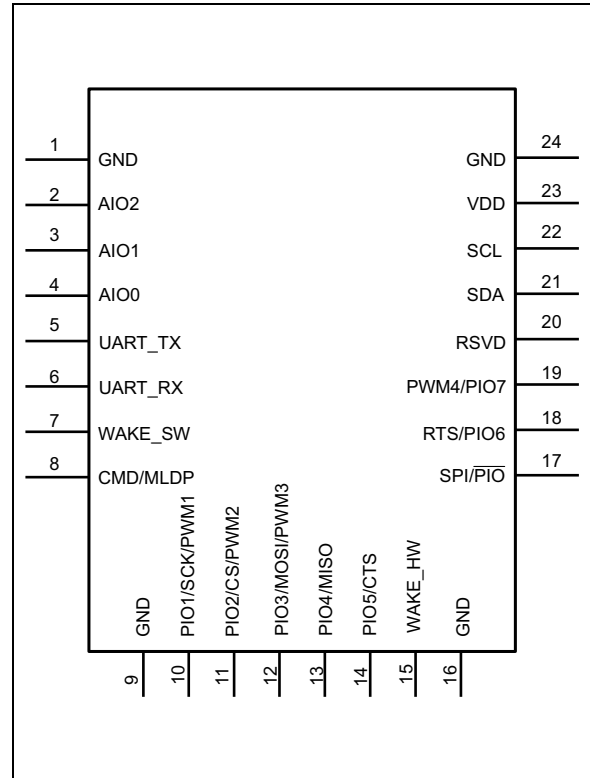
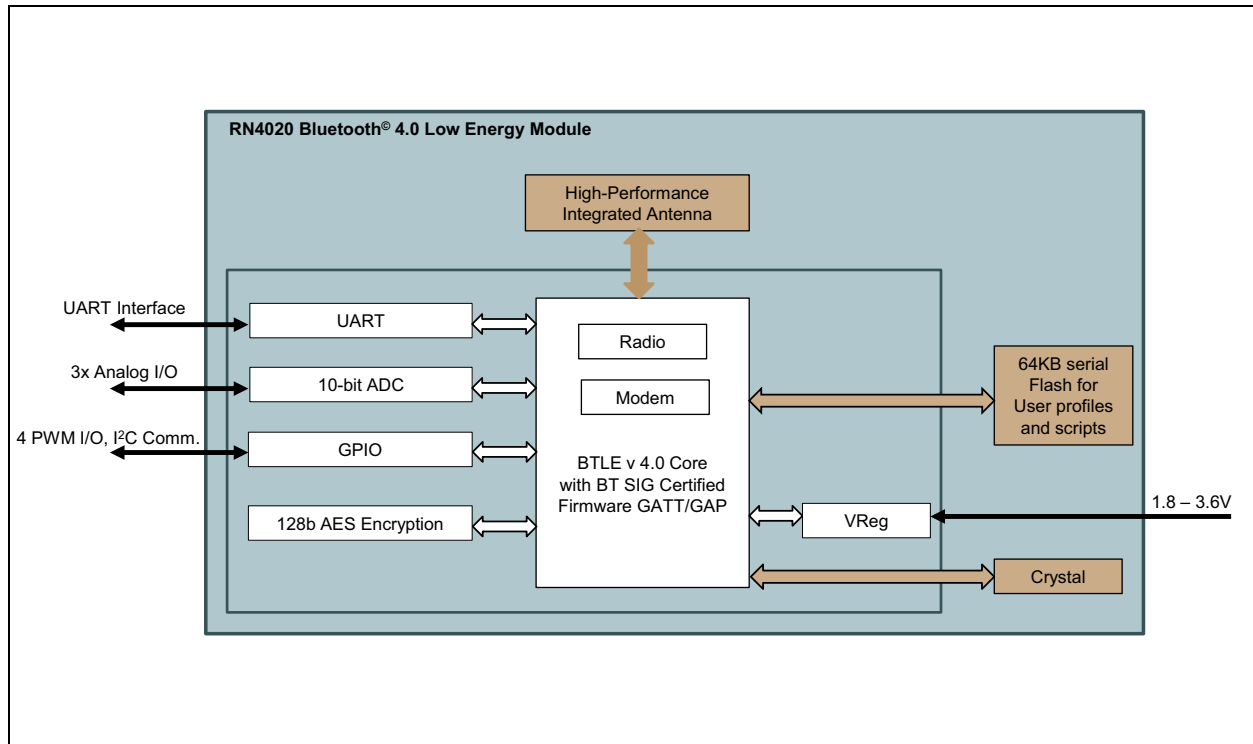

FIGURE 1-3: RN4020 BLOCK DIAGRAM



RN4020

TABLE 1-1: PIN DESCRIPTION

Pin	Name	Description	Function
1	GND	Ground	Ground
2	AIO2	Bi-directional with programmable analog I/O	1.35V and 30 mA max out
3	AIO1	Bi-directional with programmable analog I/O	1.35V and 30 mA max out
4	AIO0	Bi-directional with programmable analog I/O	1.35V and 30 mA max out
5	UART TX	UART Transmit (TX)	Output
6	UART RX	UART Receive (RX)	Input
7	WAKE_SW	Deep Sleep Wake; active-high to wake module from Deep Sleep. If the module runs without a host micro-controller, connect the UART_RX pin to VDD via a 10K resistor to conserve power in Deep Sleep.	Input; weak pull down
8	CMD/MLDP	Command or MLDP mode – In Command mode, UART traffic is sent to the command interpreter. In MLDP mode, UART traffic is routed to the MLDP Bluetooth® LED connection, if active.	Input; Edge triggered; Change from High to Low to enter CMD mode from MLDP mode
9	GND	Ground	Ground
10	CONNECTION LED PIO[1] SCK PWM1	Default state is output. Active-high indicates the module is connected to a remote device. Active-low indicates a disconnected state. Configurable as PIO[1] via software command. SCK for Diagnostics and Factory Calibration if pin 17 is asserted.	<ul style="list-style-type: none"> • Connection Status Indicator (Green LED) • PIO[1] • SCK • PWM1
11	MLDP_EV PIO[2] CS PWM2	Default function is output used for MLDP data event indicator (Red LED). Active-high indicates MLDP data received or UART console data pending. Low level indicates no events. Event is only triggered in MLDP mode, when CMD/MLDP (pin 8) is high. Configurable as PIO[2] via “ I” and “ O” commands. CS for Diagnostics and Factory Calibration if pin 17 is asserted.	<ul style="list-style-type: none"> • MLDP Data Indicator (Red LED) • PIO[2] • CS • PWM2
12	WS PIO[3] MOSI PWM3	Default function is an output used for Activity Indicator (Blue LED). High level indicates module is awake and active. Low level indicates module is in a Sleep state. Accessible as PIO[3] via “ >” and “ <” commands. MOSI for Diagnostics and Factory Calibration if pin 17 is asserted.	<ul style="list-style-type: none"> • WS (Blue LED) • PIO[3] • MOSI • PWM3
13	PIO[4] MISO	MISO for Diagnostics and Factory Calibration if pin 17 asserted.	<ul style="list-style-type: none"> • PIO[4] • MISO
14	CTS PIO[5]	Reserved for CTS if hardware flow control is enabled on the UART; active-low.	<ul style="list-style-type: none"> • CTS (input) • PIO[5]

TABLE 1-1: PIN DESCRIPTION (CONTINUED)

Pin	Name	Description	Function
15	WAKE_HW	<p>Hardware wake from Dormant state. Setting the WAKE_HW (pin15) high wakes the module from Dormant mode. During the module power up, if WAKE_HW pin is flipped high and low for three cycles (putting the WAKE_HW pin into high, low, and then high again is considered as one flip cycle) in the first five seconds, then the module performs a factory Reset. If the WAKE_SW pin is high when a factory Reset is performed, the factory Reset is a full reset. Otherwise, it is a partial reset that retains the device name, private service and scripts. Set WAKE_HW pin to low in order to lower power consumption in Deep Sleep and Dormant modes.</p> <div style="border: 1px solid black; padding: 5px; margin: 10px 0;"> <p style="text-align: center;">CAUTION</p> <p>A full factory Reset erases scripts and sets the device name to the serialized name. For more information, refer to the SF Command in the <i>RN4020 Bluetooth Low Energy User's Guide</i> (DS70005191).</p> </div>	Active-high; internal pull down
16	GND	Ground	Ground
17	SPI/PIÖ	SPI/PIÖ for pins 10-13; active-high	Input with internal pull down; selects SPI on pins 10-13
18	RTS PIO[6]	Reserved for RTS if hardware flow control on UART is enabled. If the data transmission to RN4020 must be halted, assert RTS to high. RTS pin operates independently from the CTS (pin 14).	<ul style="list-style-type: none"> • RTS (output) • PIO[6]
19	PWM4 PIO[7]	Spare PIO	PIO[7]; Spare PIO configurable as input or output
20	RSVD	Do not connect. Factory diagnostics.	No Connect
21	SDA	SDA Data line of the I ² C interface. The RN4020 always acts as the I ² C Host.	SDA
22	SCL	I ² C Clock	SCL
23	VDD	Supply voltage	1.8 to 3.6V
24	GND	Ground	Ground

RN4020

2.0 GENERAL SPECIFICATIONS

Table 2-1 provides the general specifications of the module. Table 2-2 and Table 2-3 shows the weight and dimensions, and electrical characteristics of the module. Table 2-4 and Table 2-5 specify the current consumption of the module.

TABLE 2-1: GENERAL SPECIFICATIONS

Specification	Description
Standard	Bluetooth® 4.0
Frequency Band	2.4 ~ 2.48 GHz
Modulation Method	GFSK
Maximum Data Rate	1 Mbps
Antenna	PCB
Interface	UART, PIO, AIO, SPI
Operation Range	100 meters ⁽¹⁾
Sensitivity	-92.5 dBm at 0.1% BER
RF TX Power	-19.0 dBm to +7.5 dBm
Temperature (operating)	-30°C to +85°C
Temperature (storage)	-40°C to +85°C
Humidity	10% ~ 90% non-condensing

Note 1: Maximum range under ideal conditions such as RF matching, line of sight, maximum power. Actual results may vary depending on the customer's design.

TABLE 2-2: WEIGHT AND DIMENSIONS

Specification	Description
Dimensions	11.5 mm x 19.5 mm x 2.5 mm
Weight	1.2g

TABLE 2-3: ELECTRICAL CHARACTERISTICS

Specification	Description
Supply Voltage	1.8 to 3.6V DC
Working current	Depends on profiles, 12 mA typical

TABLE 2-4: CURRENT CONSUMPTION

Mode	Typical Current at 3V
Dormant	<900 nA
Deep Sleep	<5.0 µA
Idle	<1.5 mA
TX/RX active	16 mA

TABLE 2-5: CURRENT CONSUMPTION VS RF TX POWER

RN4020, V _{DD} = 3.3V, 25°C	
TX Power (dBm)	I _d (mA)
-19.1	14.0
-15.1	14.4
-10.9	15.0
-6.9	15.9
-2.5	17.6
1.6	20.7
5.8	26.9
7.5	33.6

3.0 MICROCONTROLLER TO RN4020 INTERFACE

Figure 3-1 illustrates the interface between PIC microcontroller and the RN4020 module.

The minimum interface consists of UART and WAKE_HW lines. This enables the microcontroller to communicate with the RN4020 module using ASCII command API. The command API is described in Section 6.0 “ASCII Command API”.

3.1 CTS/RTS Hardware Flow Control

For customer applications using the Microchip Low-energy Data Profile, Pin 8 (CMD/MLDP) is required. CTS/RTS hardware control is also required for this service to avoid buffer overruns.

3.2 Microchip Low-energy Data Profile (MLDP)

The Microchip Low-energy Data Profile is a private BTLE service that provides a 50 kbps serial data transport over Bluetooth Low Energy on the RN4020. Pin 8 (CMD/MLDP) is required. CTS/RTS hardware control is also highly recommended for this service to avoid data loss.

For more information on how to use the MLDP data service, refer to *RN4020 Bluetooth Low Energy Module User’s Guide* (DS70005191).

FIGURE 3-1: INTERFACE DESCRIPTION

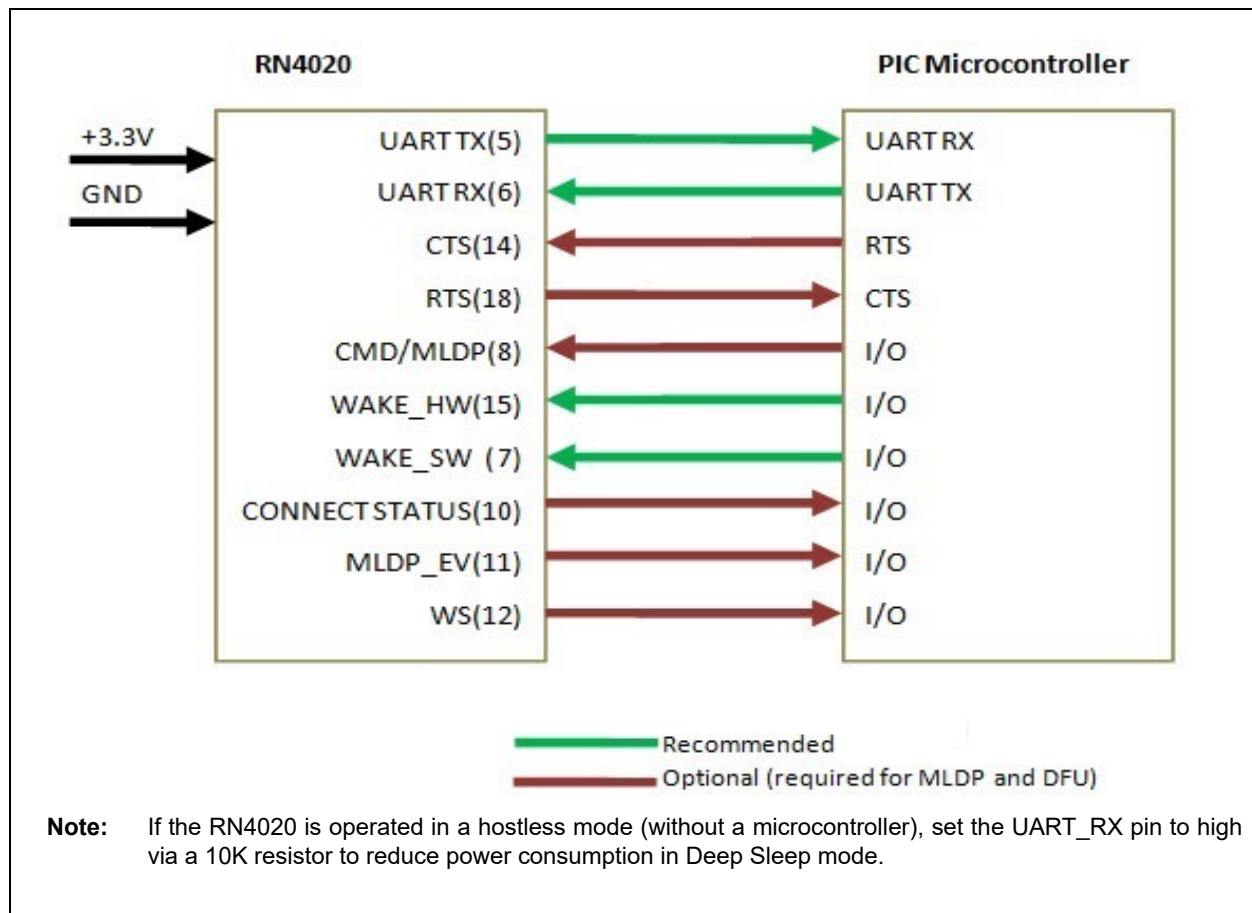

RN4020

4.0 PHYSICAL DIMENSIONS

Figure 4-1 shows the physical dimensions for RN4020 module. Figure 4-2 illustrates the recommended PCB layout. It is recommended that when laying out the carrier board for the RN4020 module, the areas under the antenna, RF test point (semi-circular pad), and shielding connections do not contain surface traces, ground planes, or exposed vias.

Figure 4-3 specifies the recommended mounting details. For optimal radio performance, it is recommended that the antenna end of the RN4020 module protrudes at least 31 mm beyond any metal enclosure. Figure 4-4 shows an example of good and acceptable positioning of the RN4020 on the host PCB.

FIGURE 4-1: RN4020 MODULE DIMENSIONS

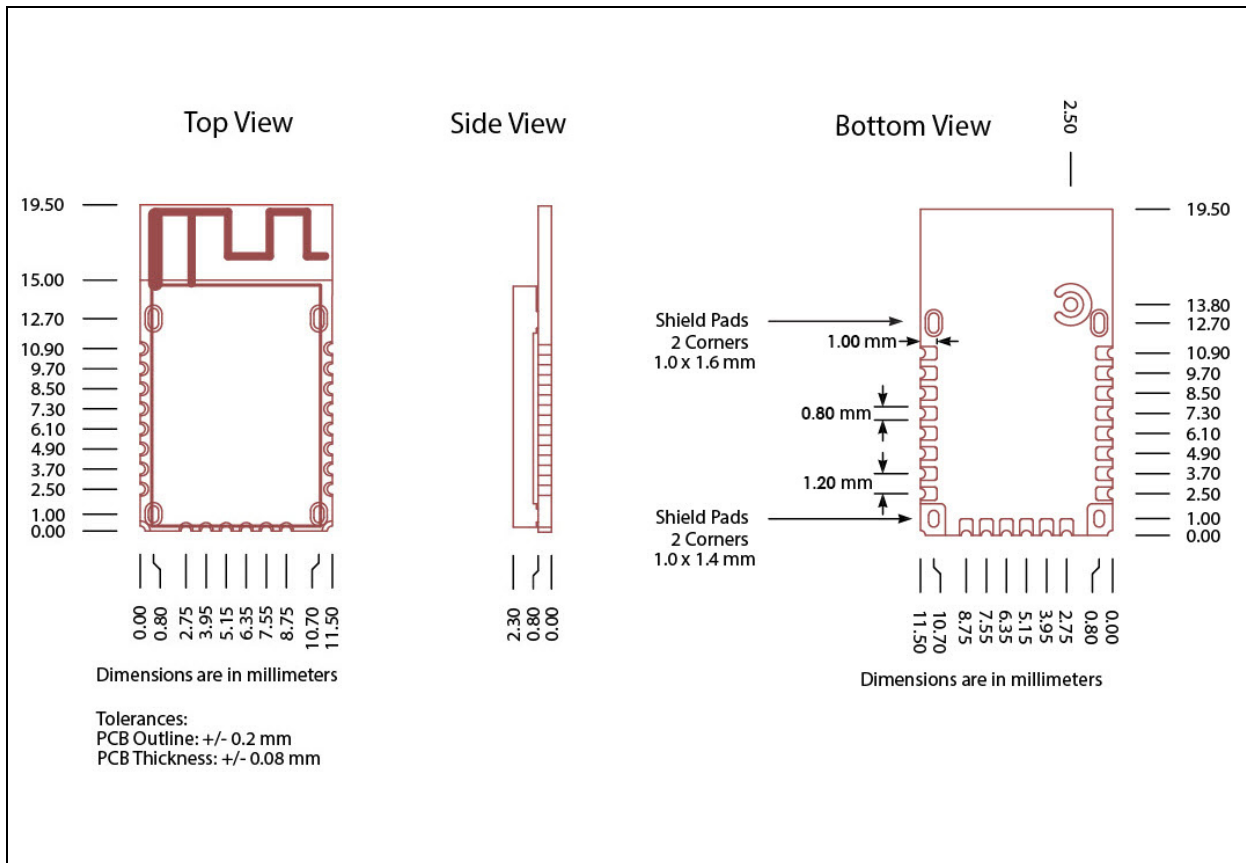

FIGURE 4-2: RN4020 RECOMMENDED PCB FOOTPRINT

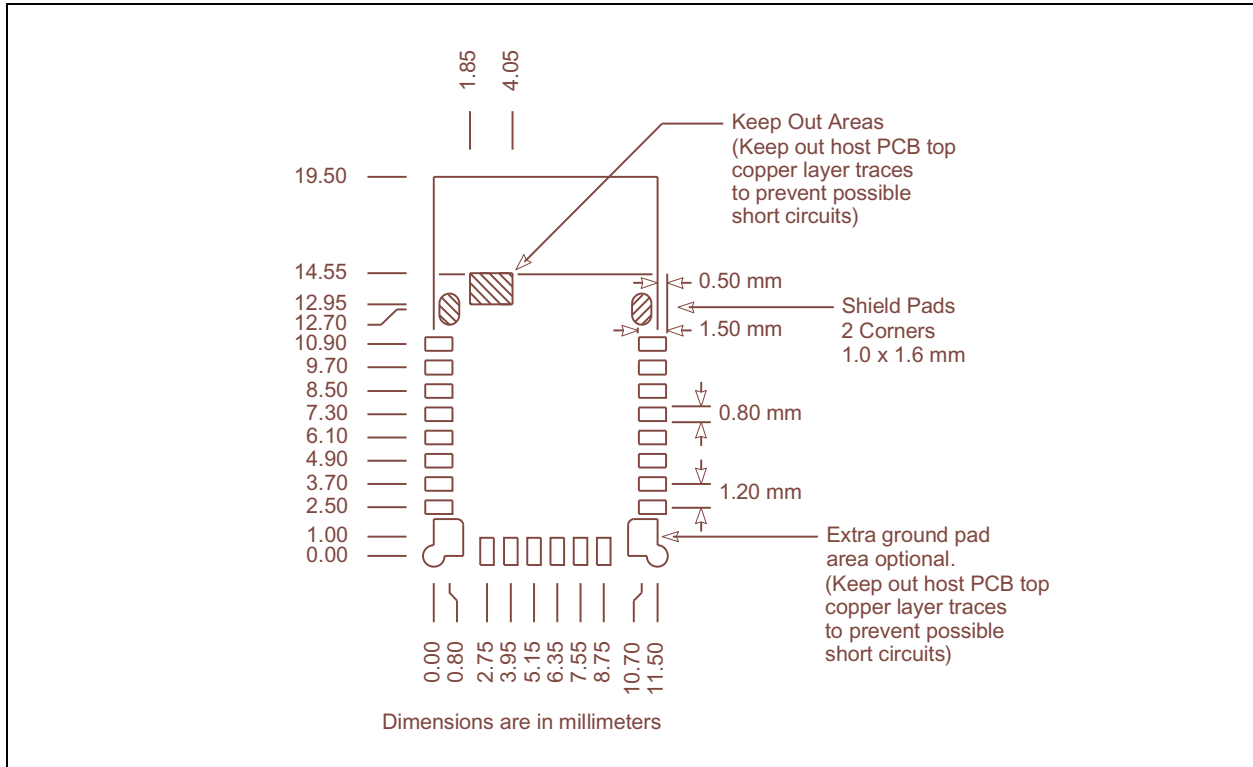
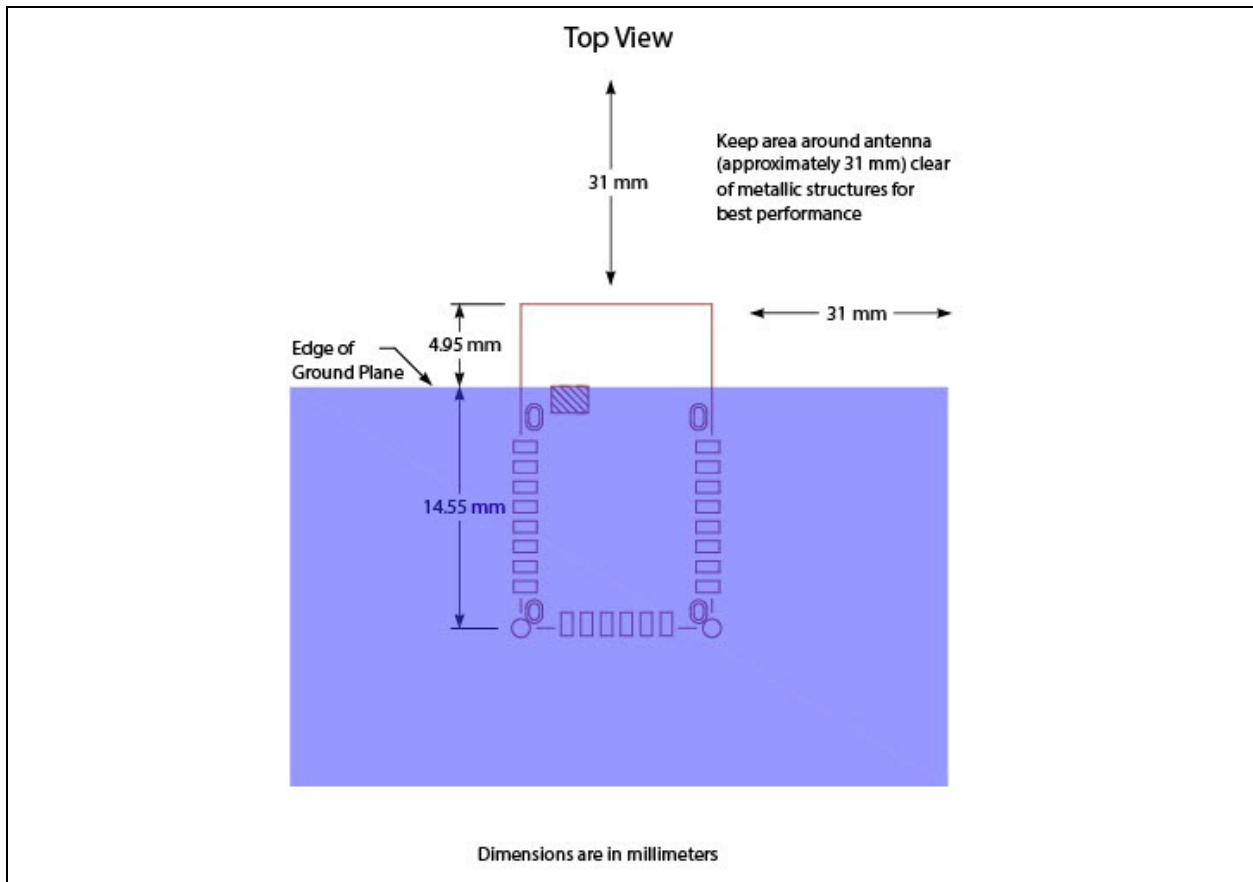
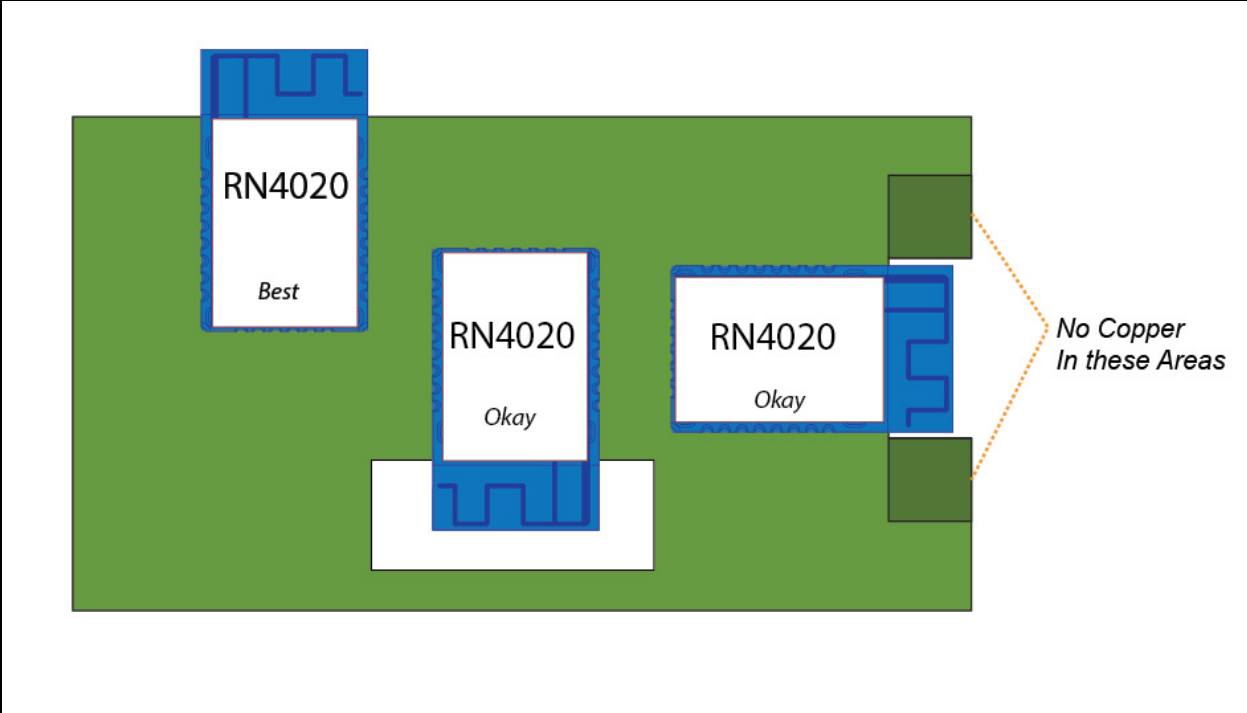

FIGURE 4-3: RN4020 MODULE MOUNTING DETAILS



RN4020

FIGURE 4-4: RN4020 HOST PCB EXAMPLE LAYOUT



5.0 TYPICAL APPLICATION SCHEMATIC

The following figure shows the schematics for the RN4020 Bluetooth Low Energy PICtail™/PICtail Plus development tool (P/N: RN-4020-PICtail).

FIGURE 5-1: RN4020 TYPICAL APPLICATION SCHEMATICS

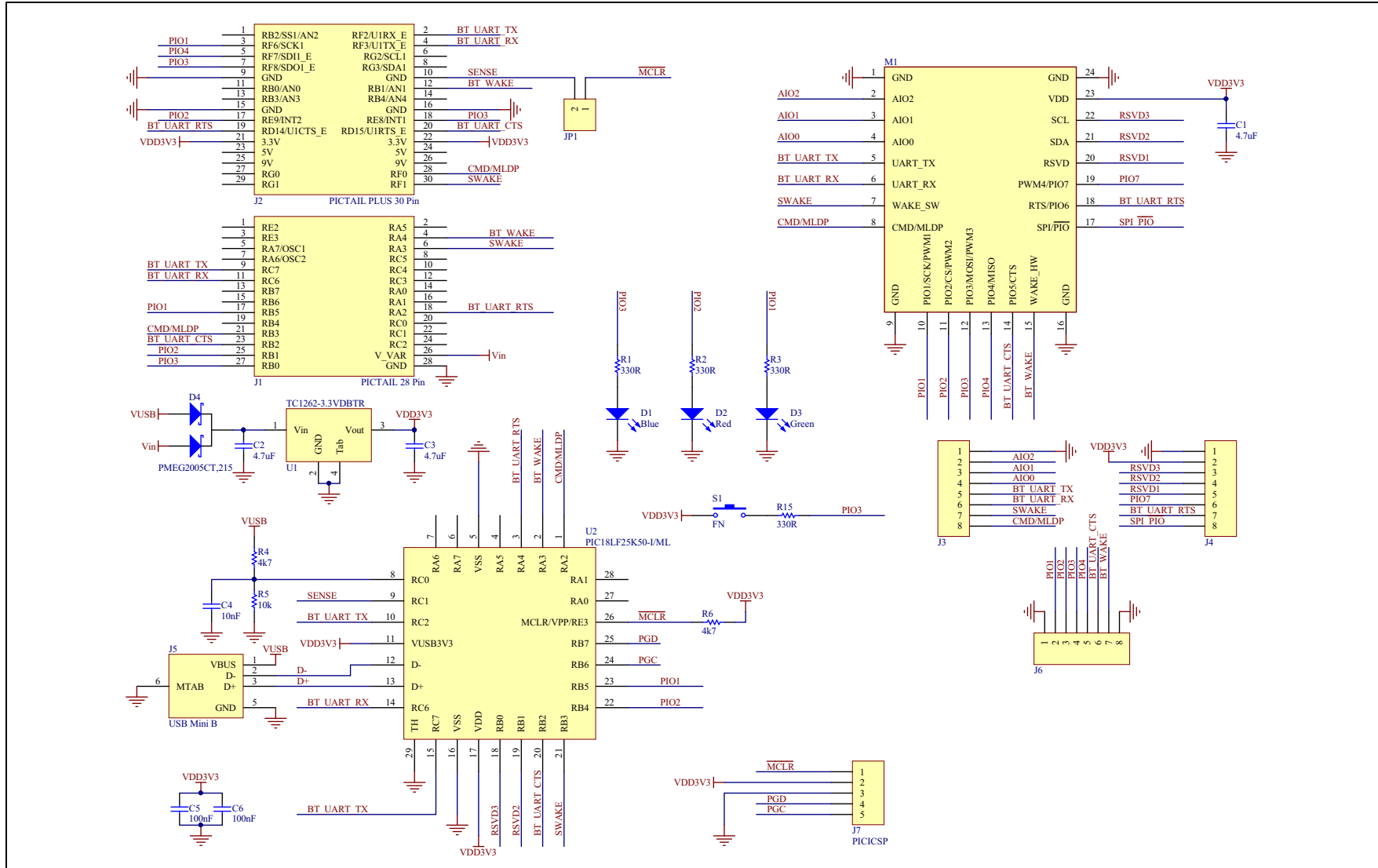

RN4020

6.0 ASCII COMMAND API

The RN4020 command API is documented in *RN4020 Bluetooth Low Energy Module User's Guide* (DS70005191).

Commands are categorized into the following functions:

- Built-in Public Services
 - Enable/Disable service as Server or Client
 - Read/Write characteristic values
 - Set notification for characteristic
- Max TX Power
 - Set power in dB
- GAP Role
 - Central, Peripheral, Observer and Broadcaster
- Advertising
 - Start/Stop
- Bonding
 - Bond/Unbound to Host
- Private Service
 - Set private service UUID
 - Set characteristic UUID for private service
 - Set private service filter
- Microchip Low-energy Data Profile (MLDP)
 - Enable
 - Enter MLDP mode
 - Peripheral side configuration
 - Central side configuration
- Device Information Profile settings
- Connection
 - Status
 - Disconnect
 - Kill active connection
 - Establish connection (Central role only)
 - Start/Stop inquiry scan for other devices (Central role only)
- IO
 - Configure GPIO mask
 - Set/Get GPIO states
 - Read and Write ADC values
 - Read/Write I²C
 - Configure PWM
 - Device Firmware Update
 - Accessing remote configuration
- System
 - Reboot
 - Factory default
 - Display configuration
- Scripting
 - Enter script mode
 - Declare event handler
 - Execute current script
 - List current script
 - Clear script
 - Define User function

7.0 SUPPORTED SERVICES

The RN4020 firmware support the built-in public services listed in the following table. The services are enabled via Command API and serviced in the same manner. Each service manages “Characteristics” which are declared and defined by Bluetooth as data values. The values for each characteristic are cached in modules memory and can be read by another Bluetooth device such as smartphone acting in Central role. The values of every Characteristic are updated via Command API over UART.

TABLE 7-1: SUPPORTED PUBLIC SERVICES ON RN4020⁽¹⁾

Service Name	Bluetooth® SIG UUID
Device Information	0x180A
Battery	0x180F
Heart Rate	0x180D
Health Thermometer	0x1809
Glucose	0x1808
Blood Pressure	0x1810
Running Speed Cadence	0x1814
Cycling Speed Cadence	0x1816
Current Time	0x1805
Next DST Change	0x1807
Reference Time Update	0x1806
Link Loss	0x1803
Immediate Alert	0x1802
TX Power	0x1804
Alert Notification	0x1811
Phone Alert Status	0x180E
Scan Parameters	0x1813

Note 1: The services listed above are based on firmware version 1.20. For the latest list of supported services, refer to the firmware version on the RN4020 web page.

7.1 Public and Private Services

The RN4020 provides the ability to create private service. If the services are supported on both end points of a Bluetooth Low Energy connection, such as Central and Peripheral devices, data can be exchanged. For example, two RN4020 modules can define a custom (private) service with its own unique UUID and GATT characteristics. Data can be exchanged easily via Command API.

Private services are not registered with the Bluetooth SIG, and therefore not interoperable with other Bluetooth Low Energy devices, unless the device implements the private service. An example of a built-in private service is Microchip Streaming Data service.

For an example on how to create a custom service using the RN4020, refer to *RN4020 Bluetooth Low Energy Module User's Guide* (DS70005191).

7.2 PCB Antenna

The PCB antenna is fabricated on the top copper layer and covered in solder mask. The layers below the antenna do not have copper trace. It is recommended that the module is mounted on the edge of the host PCB. Having PCB material below the antenna structure is permitted as long as no copper traces or planes are on the host PCB in that area.

The following table provides the antenna specification.

TABLE 7-2: ANTENNA CHARACTERISTICS

Specification	Description
Type	PCB
Frequency Range	2.402 to 2.485 MHz
Peak Gain	-0.23 dBi

The following three figures show the antenna efficiency, the antenna plot, and the 3D radiation pattern.

FIGURE 7-1: EFFICIENCY

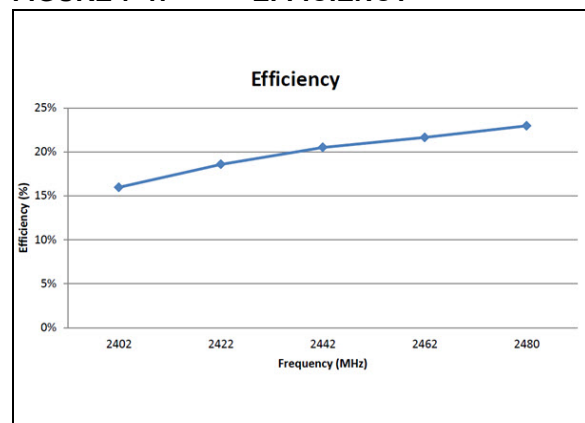

RN4020

FIGURE 7-2: ANTENNA PLOT

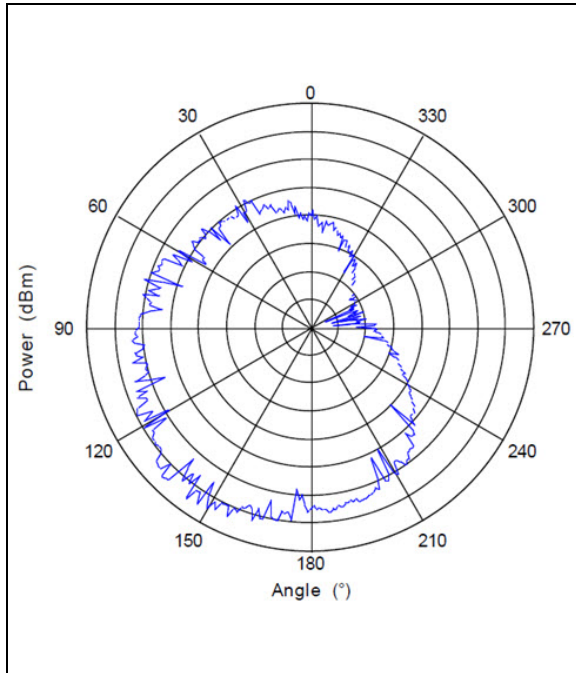
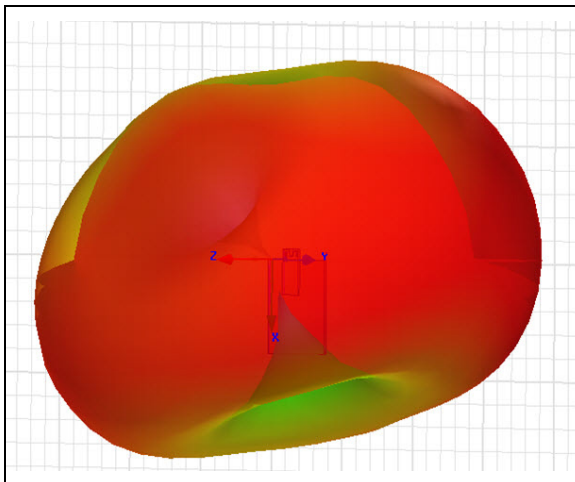

FIGURE 7-3: 3D RADIATION PATTERN AND ANTENNA ORIENTATION



7.3 Soldering Recommendations

The RN4020 wireless module is assembled using standard lead-free reflow profile IPC/JEDEC J-STD-020.

The module can be soldered to the host PCB using standard leaded and lead-free solder reflow profiles.

To avoid damaging the module, the following recommendations are given:

- Microchip Technology Application Note, *AN233 Solder Reflow Recommendation* (DS00233) provides solder reflow recommendations
- Do not exceed peak temperature (T_p) of 250°C
- Refer to the solder paste data sheet for specific reflow profile recommendations
- Use no-clean flux solder paste
- Do not wash as moisture can be trapped under the shield
- Use only one flow. If the PCB requires multiple flows, apply the module on the final flow.

8.0 REGULATORY APPROVAL

This section outlines the regulatory information for the RN4020 module for the following countries:

- United States
- Canada
- Europe
- Australia
- New Zealand
- Japan
- Korea
- Taiwan

8.1 United States

The RN4020 module has received Federal Communications Commission (FCC) CFR47 Telecommunications, Part 15 Subpart C “Intentional Radiators” modular approval in accordance with Part 15.212 Modular Transmitter approval. Modular approval allows the end user to integrate the RN4020 module into a finished product without obtaining subsequent and separate FCC approvals for intentional radiation, provided no changes or modifications are made to the module circuitry. Changes or modifications could void the user’s authority to operate the equipment. The end user must comply with all of the instructions provided by the Grantee, which indicate installation and/or operating conditions necessary for compliance.

The finished product is required to comply with all applicable FCC equipment authorizations regulations, requirements and equipment functions not associated with the transmitter module portion. For example, compliance must be demonstrated to regulations for other transmitter components within the host product; to requirements for unintentional radiators (Part 15 Subpart B “Unintentional Radiators”), such as digital devices, computer peripherals, radio receivers, etc.; and to additional authorization requirements for the non-transmitter functions on the transmitter module (i.e., Verification, or Declaration of Conformity) (e.g., transmitter modules may also contain digital logic functions) as appropriate.

8.1.1 LABELING AND USER INFORMATION REQUIREMENTS

The RN4020 module has been labeled with its own FCC ID number, and if the FCC ID is not visible when the module is installed inside another device, then the outside of the finished product into which the module is installed must also display a label referring to the enclosed module. This exterior label can use wording as follows:

RN4020:
Contains Transmitter Module FCC ID: T9JRN4020
or

Contains FCC ID: T9JRN4020

This device complies with Part 15 of the FCC Rules. Operation is subject to the following two conditions: (1) this device may not cause harmful interference, and (2) this device must accept any interference received, including interference that may cause undesired operation

A user’s manual for the product should include the following statement:

This equipment has been tested and found to comply with the limits for a Class B digital device, pursuant to part 15 of the FCC Rules. These limits are designed to provide reasonable protection against harmful interference in a residential installation. This equipment generates, uses and can radiate radio frequency energy, and if not installed and used in accordance with the instructions, may cause harmful interference to radio communications. However, there is no guarantee that interference will not occur in a particular installation. If this equipment does cause harmful interference to radio or television reception, which can be determined by turning the equipment off and on, the user is encouraged to try to correct the interference by one or more of the following measures:

- Reorient or relocate the receiving antenna.
- Increase the separation between the equipment and receiver.
- Connect the equipment into an outlet on a circuit different from that to which the receiver is connected.
- Consult the dealer or an experienced radio/TV technician for help.

Additional information on labeling and user information requirements for Part 15 devices can be found in KDB Publication 784748 available at the FCC Office of Engineering and Technology (OET) Laboratory Division Knowledge Database (KDB)

<http://apps.fcc.gov/oetcf/kdb/index.cfm>

8.1.2 RF EXPOSURE

All transmitters regulated by FCC must comply with RF exposure requirements. KDB 447498 General RF Exposure Guidance provides guidance in determining whether proposed or existing transmitting facilities, operations or devices comply with limits for human exposure to Radio Frequency (RF) fields adopted by the Federal Communications Commission (FCC).

This module is approved for installation into mobile and/or portable host platforms and must not be co-located or operating in conjunction with any other antenna or transmitter except in accordance with FCC multitransmitter guidelines. End users must be provided with transmitter operating conditions for satisfying RF Exposure compliance.

8.1.3 APPROVED ANTENNA

To maintain modular approval in the United States, only the antenna types that have been tested shall be used. It is permissible to use different antenna provided the same antenna type and antenna gain (equal to or less than) is used. An antenna type comprises antennas having similar in-band and out-of-band radiation patterns.

For RN4020, approved antennas are listed in [Table 7-2](#).

8.1.4 HELPFUL WEB SITES

Federal Communications Commission (FCC):
<http://www.fcc.gov>

FCC Office of Engineering and Technology (OET) Laboratory Division Knowledge Database (KDB):
<http://apps.fcc.gov/oetcf/kdb/index.cfm>

8.2 Canada

The RN4020 module has been certified for use in Canada under Innovation, Science and Economic Development Canada (ISED, formerly Industry Canada) Radio Standards Specification (RSS) RSS-210 and RSSGen. Modular approval permits the installation of a module in a host device without the need to recertify the device.

8.2.1 LABELING AND USER INFORMATION REQUIREMENTS

Labeling Requirements for the Host Device (from Section 5, RSP-100, Issue 12, March 2019): The host device shall be properly labeled to identify the module within the host device.

The Industry Canada certification label of a module shall be clearly visible at all times when installed in the host device, otherwise the host device must be labeled to display the Industry Canada certification number of

the module, preceded by the words “Contains transmitter module”, or the word “Contains”, or similar wording expressing the same meaning, as follows:

Contains transmitter module IC: 6514A-RN4020

User Manual Notice for License-Exempt Radio Apparatus (from Section 8.4 RSS-Gen, Issue 5, March 2019): User manuals for license-exempt radio apparatus shall contain the following or equivalent notice in a conspicuous location in the user manual or alternatively on the device or both:

This device contains license-exempt transmitter(s)/ receiver(s) that comply with Innovation, Science and Economic Development Canada’s license-exempt RSS (s). Operation is subject to the following two conditions:

1. This device may not cause interference.
2. This device must accept any interference, including interference that may cause undesired operation of the device.

L'émetteur/récepteur exempt de licence contenu dans le présent appareil est conforme aux CNR d'Innovation, Sciences et Développement économique Canada applicables aux appareils radio exempts de licence. L'exploitation est autorisée aux deux conditions suivantes:

1. L'appareil ne doit pas produire de brouillage;
2. L'appareil doit accepter tout brouillage radioélectrique subi, même si le brouillage est susceptible d'en compromettre le fonctionnement.

Transmitter Antenna (From Section 6.8 RSS-GEN, Issue 5, March 2019): User manuals, for transmitters shall display the following notice in a conspicuous location:

This radio transmitter [IC: 6514A-RN4020] has been approved by Innovation, Science and Economic Development Canada to operate with the antenna types listed below, with the maximum permissible gain indicated. Antenna types not included in this list that have a gain greater than the maximum gain indicated for any type listed are strictly prohibited for use with this device.

Le présent émetteur radio [IC: 6514A-RN4020] a été approuvé par Innovation, Sciences et Développement économique Canada pour fonctionner avec les types d'antenne énumérés ci-dessous et ayant un gain admissible maximal. Les types d'antenne non inclus dans cette liste, et dont le gain est supérieur au gain maximal indiqué pour tout type figurant sur la liste, sont strictement interdits pour l'exploitation de l'émetteur

Immediately following the above notice, the manufacturer shall provide a list of all antenna types approved for use with the transmitter, indicating the maximum permissible antenna gain (in dBi) and required impedance for each.

8.2.2 RF EXPOSURE

All transmitters regulated by Innovation, Science and Economic Development Canada (ISED) must comply with RF exposure requirements listed in RSS-102 - Radio Frequency (RF) Exposure Compliance of Radio-communication Apparatus (All Frequency Bands).

This module is approved for installation into mobile and/or portable host platforms and must not be co-located or operating in conjunction with any other antenna or transmitter except in accordance with Industry Canada's multi-transmitter guidelines. End users must be provided with transmitter operating conditions for satisfying RF Exposure compliance.

8.2.3 APPROVED EXTERNAL ANTENNA TYPES

Transmitter Antenna (from Section 7.1.2 RSS-Gen, Issue 3, December 2010):

The RN4020 module can only be sold or operated with antennas with which it was approved. Transmitter may be approved with multiple antenna types. An antenna type comprises antennas having similar in-band and out-of-band radiation patterns. Testing shall be performed using the highest gain antenna of each combination of transmitter and antenna type for which approval is being sought, with the transmitter output power set at the maximum level. Any antenna of the same type having equal or lesser gain as an antenna that had been successfully tested with the transmitter, will also be considered approved with the transmitter, and may be used and marketed with the transmitter.

When a measurement at the antenna connector is used to determine RF output power, the effective gain of the device's antenna shall be stated, based on measurement or on data from the antenna manufacturer. For transmitters of output power greater than 10 milliwatts, the total antenna gain shall be added to the measured RF output power to demonstrate compliance to the specified radiated power limits. For RN4020, the approval is received using the antenna listed in [Table 7-2](#).

8.2.4 HELPFUL WEB SITES

Industry Canada: <http://www.ic.gc.ca/>

8.3 Europe

The RN4020 module is Radio Equipment Directive (RED) assessed, CE marked, and have been manufactured and tested with the intention of being integrated into a final product.

The RN4020 module has been tested to RED 2014/53/EU Essential Requirements mentioned in the following European Compliance table.

TABLE 8-1: EUROPEAN COMPLIANCE

Certification	Standards	Article
Safety	EN 62368	3.1a
Health	EN 62311	
Electro Magnetic Compatibility (EMC)	EN 301 489-1	3.1b
	EN 301 489-17	
Radio	EN 300 328	3.2

The ETSI provides guidance on modular devices in “*Guide to the application of harmonized standards covering Article 3.1b and Article 3.2 of the Directive 2014/53/EU RED to multi-radio and combined radio and non-radio equipment*” document available at http://www.etsi.org/deliver/etsi_eg/203300_203399/203367/01.01.01_60/eg_203367v010101p.pdf

Note: To maintain conformance to the testing listed in [Table 8-1](#), the module shall be installed in accordance with the installation instructions in this data sheet and shall not be modified. When integrating a radio module into a completed product the integrator becomes the manufacturer of the final product and is therefore responsible for demonstrating compliance of the final product with the essential requirements against RED.

8.3.1 LABELING AND USER INFORMATION REQUIREMENTS

The label on the final product which contains the RN4020 module must follow CE marking requirements

8.3.2 CONFORMITY ASSESSMENT

From ETSI Guidance Note EG 203367, section 6.1 Non-radio products are combined with a radio product:

If the manufacturer of the combined equipment installs the radio product in a host non-radio product in equivalent assessment conditions (host equivalent to the one used for the assessment of the radio product) and according to the installation instructions for the radio product, then no additional assessment of the combined equipment against article 3.2 of the RED is required.

8.3.2.1 SIMPLIFIED EU DECLARATION OF CONFORMITY

Hereby, Microchip Technology Inc. declares that the radio equipment type RN4020 is in compliance with Directive 2014/53/EU.

The full text of the EU declaration of conformity, for this product, is available at:

<https://www.microchip.com/en-us/product/RN4020>

(available under Documents > Certifications).

8.3.3 APPROVED ANTENNAS

For RN4020, the approval is received using the integral PCB antenna listed in [Table 7-2](#).

8.3.4 HELPFUL WEB SITES

A document that can be used as a starting point in understanding the use of Short Range Devices (SRD) in Europe is the European Radio Communications Committee (ERC) Recommendation 70-03 E, which can be downloaded from the European Radio Communications Office (ERO) at: <http://www.ero.dk/>.

Additional helpful web sites are:

- Radio Equipment Directive (2014/53/EU): <https://ec.europa.eu/growth/single-market/euro>
- European Conference of Postal and Telecommunications Administrations (CEPT): <http://www.cept.org/>
- European Telecommunications Standards Institute (ETSI): <http://www.etsi.org>

The Radio Equipment Directive Compliance Association (REDCA): <http://www.redca.eu/>

8.4 Australia

The Australia radio regulations do not provide a modular approval policy similar to the United States (FCC) and Canada (ISED). However, RN4020 module RF transmitter test reports can be used in part to demonstrate compliance in accordance with ACMA Radio communications “Short Range Devices” Standard 2004 (The Short Range Devices standard calls up the AS/NZS 4268:2008 industry standard). The RN4020 module test reports can be used as part of the product certification and compliance folder. For more information on the RF transmitter test reports, contact Microchip Technology Australia sales office.

To meet overall Australian final product compliance, the developer must construct a compliance folder containing all relevant compliance test reports e.g. RF, EMC, electrical safety and DoC (Declaration of Conformity) etc. It is the responsibility of the integrator to know what is required in the compliance folder for ACMA compliance. All test reports are available on the RN4020 product web page at <http://www.microchip.com>. For more information on Australia compliance, refer to the Australian Communications and Media Authority web site <http://www.acma.gov.au/>.

8.4.1 HELPFUL WEB SITE

The Australian Communications and Media Authority: www.acma.gov.au/.

8.5 New Zealand

The New Zealand radio regulations do not provide a modular approval policy similar to the United States (FCC) and Canada (ISED). However, RN4020 module RF transmitter test reports can be used in part to demonstrate compliance against the New Zealand “General User Radio License for Short Range Devices”. New Zealand Radio communications (Radio Standards) Notice 2010 calls up the AS / NZS 4268:2008 industry standard. The RN4020 module test reports can be used as part of the product certification and compliance folder. All test reports are available on the RN4020 product web page at <http://www.microchip.com>. For more information on the RF transmitter test reports, contact Microchip Technology sales office.

Information on the New Zealand short range devices license can be found in the following web links:

<http://www.rsm.govt.nz/cms/licensees/types-of-licence/general-user-licences/short-range-devices>

and

<http://www.rsm.govt.nz/cms/policy-and-planning/spectrum-policy-overview/legislation/gazette-notices/product-compliance>

To meet overall New Zealand final product compliance, the developer must construct a compliance folder containing all relevant compliance test reports e.g. RF, EMC, electrical safety and DoC (Declaration of Conformity) etc. It is the responsibility of the developer to know what is required in the compliance folder for New Zealand Radio communications. For more information on New Zealand compliance, refer to the web site

<http://www.rsm.govt.nz/>.

8.6 Japan

The RN4020 module has received type certification and is labeled with its own technical conformity mark and certification number as required to conform to the technical standards regulated by the Ministry of Internal Affairs and Communications (MIC) of Japan pursuant to the Radio Act of Japan.

Integration of this module into a final product does not require additional radio certification provided installation instructions are followed and no modifications of the module are allowed. Additional testing may be required:

- If the host product is subject to electrical appliance safety (for example, powered from an AC mains), the host product may require Product Safety Electrical Appliance and Material (PSE) testing. The integrator should contact their conformance laboratory to determine if this testing is required.
- There is an voluntary Electromagnetic Compatibility (EMC) test for the host product administered

by VCCI: http://www.vcci.jp/vcci_e/index.html

8.6.1 LABELING AND USER INFORMATION REQUIREMENTS

The label on the final product which contains the RN4020 module must follow Japan marking requirements. The integrator of the module should refer to the labeling requirements for Japan available at the Ministry of Internal Affairs and Communications (MIC) website.

The RN4020 module is labeled with its own technical conformity mark and certification number. The final product in which this module is being used must have a label referring to the type certified module inside:

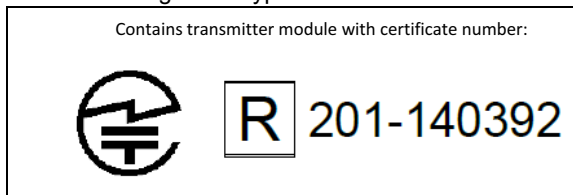

8.6.2 4.6.2 HELPFUL WEB SITES

Ministry of Internal Affairs and Communications (MIC):
<http://www.tele.soumu.go.jp/e/index.htm>

Association of Radio Industries and Businesses (ARIB): <http://www.arib.or.jp/english/>

8.7 Korea

The RN4020 module has received certification of conformity in accordance with the Radio Waves Act. Integration of this module into a final product does not require additional radio certification provided installation instructions are followed and no modifications of the module are allowed.

8.7.1 LABELING AND USER INFORMATION REQUIREMENTS

The label on the final product which contains the RN4020 module must follow KC marking requirements. The integrator of the module should refer to the labeling requirements for Korea available on the Korea Communications Commission (KCC) website.

The RN4020 module is labeled with its own KC mark. The final product requires the KC mark and certificate number of the module:

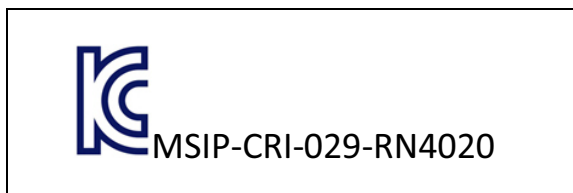

8.7.2 HELPFUL WEB SITES

Korea Communications Commission (KCC):
<http://www.kcc.go.kr>

National Radio Research Agency (RRA):
<http://rra.go.kr>

8.8 Taiwan

The RN4020 module has received compliance approval in accordance with the Telecommunications Act. Customers seeking to use the compliance approval in their product should contact Microchip Technology sales or distribution partners to obtain a Letter of Authority.

Integration of this module into a final product does not require additional radio certification provided installation instructions are followed and no modifications of the module are allowed.

8.8.1 LABELING AND USER INFORMATION REQUIREMENTS

The RN4020 module is labeled with its own NCC mark and certificate number as below:

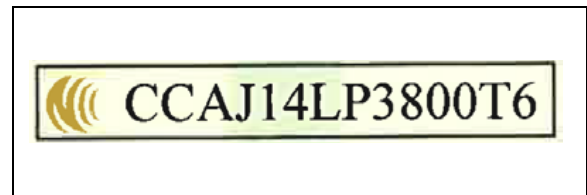

The user's manual should contain below warning (for RF device) in traditional Chinese:

注意！

依據 低功率電波輻射性電機管理辦法
第十二條 經型式認證合格之低功率射頻電機，非經許可，

公司、商號或使用者均不得擅自變更頻率、加大功率或變更原設計之特性及功能。

第十四條 低功率射頻電機之使用不得影響飛航安全及干擾合法通信；

經發現有干擾現象時，應立即停用，並改善至無干擾時方得繼續使用。

前項合法通信，指依電信規定作業之無線電信。

低功率射頻電機須忍受合法通信或工業、科學及醫療用電波輻射性

電機設備之干擾。

RN4020

8.8.2 HELPFUL WEB SITE

National Communications Commission (NCC):
<http://www.ncc.gov.tw>.

8.9 UKCA (UK Conformity Assessed)

The RN4020 module is a UK conformity assessed radio module that meets all the essential requirements according to CE RED requirements.

8.9.1 LABELING REQUIREMENTS FOR MODULE AND USER'S REQUIREMENTS

The label on the final product that contains the RN4020 module must follow the UKCA marking requirements.



The UKCA mark above is printed on the module itself or on the packing label.

Additional details for the label requirement are available at:

<https://www.gov.uk/guidance/using-the-ukca-marking#check-whether-you-need-to-use-the-new-ukca-marking>.

8.9.2 UKCA DECLARATION OF CONFORMITY

Hereby, Microchip Technology Inc. declares that the radio equipment type RN4020 is in compliance with the Radio Equipment Regulations 2017.

The full text of the UKCA declaration of conformity for this product is available (under *Documents > Certifications*) at:

- <https://www.microchip.com/en-us/product/RN4020>

8.9.3 APPROVED ANTENNAS

The testing of the RN4020 module was performed with the antennas listed in [Table 7-2](#).

8.9.4 HELPFUL WEB SITES

For more information on the UKCA regulatory approvals, refer to the <https://www.gov.uk/guidance/placing-manufactured-goods-on-the-market-in-great-britain>.

8.10 China

The RN4020 module has received certification of conformity in accordance with the China MIIT Notice 2014-01 of State Radio Regulation Committee (SRRC) certification scheme. Integration of this module into a final product does not require additional radio certification, provided installation instructions are followed and no modifications of the module are allowed. Refer to SRRC certificate available in the RN4020 product page for expiry date.

8.10.1 LABELING AND USER INFORMATION REQUIREMENTS

The RN4020 module is labeled with its own CMIIT ID as follows:

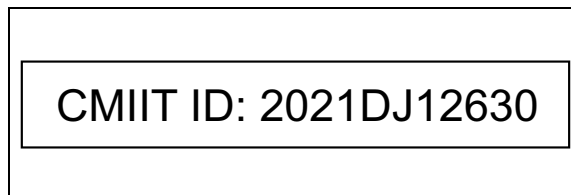

When Host system is using an approved Full Modular Approval (FMA) radio: The host must bear a label containing the statement "This device contains SRRC approved Radio module CMIIT ID: 2021DJ12630".

9.0 ORDERING INFORMATION

The following table provides ordering information for the RN4020 module.

TABLE 9-1: ORDERING INFORMATION

Part Number	Description
RN4020-V/RM	Standard firmware (GATT, GAP, L2CAP) peripheral and Central mode

Note: For custom applications, contact Microchip representative.

Go to <http://www.microchip.com> for current pricing and a list of distributors carrying Microchip products.

Go to <http://www.microchip.com/RN4020> for latest RN4020 firmware update.

RN4020

NOTES:

APPENDIX A: REVISION HISTORY

Revision A (June 2014)

This is the initial released version of the document in the Microchip format.

Revision B (September 2015)

This revision includes the following updates:

- Updated information for single operating voltage from 3.0V to 3.6V to show 1.8V to 3.6V on page 1.
- Updated [Figure 1-2](#) to change pin names for pin numbers 10, 11, 12, 19, 21 and 22.
- Updated [Figure 1-3](#) to include current inputs and outputs.
- Updated [Table 1-1](#) for changes in pin names, description, and functions.
- Added a Note in [Table 2-1](#).
- Added [Table 2-5](#).
- Added a Note in [Figure 3-1](#).
- Updated [Figure 4-2](#).
- Updated [Figure 4-4](#).

Note 1: *Microchip is aware that some terminologies used in the technical documents and existing software codes of this product are outdated and unsuitable. This document may use these new terminologies, which may or may not reflect on the source codes, software GUIs, and the documents referenced within this document. The following table shows the relevant terminology changes made in this document*

- Updated [Figure 5-1](#).
- Updated [Section 6.0 “ASCII Command API”](#) to add information for GAP Role, MLDP, IO, and Scripting functions.
- Added a Note in [Table 7-1](#).
- Updated [Section 8.0 “Regulatory Approval”](#) to add the regulatory information for Japan, Korea, and Taiwan.
- Minor updates to text and formatting have been incorporated throughout the document.

Revision C (March 2021)

This revision includes the following updates:

- Changed Master to Host in [Section 1.0 “Device Overview”](#) and [Section 6.0 “ASCII Command API”](#)
- Added [Section 8.1.3 “Approved Antenna”](#)
- Updated [Section 8.2.1 “Labeling and User Information Requirements”](#)
- Updated [Section 8.2.3 “Approved External Antenna Types”](#)
- Updated [Section 8.3 “Europe”](#)

TABLE C-1: TERMINOLOGY RELATED CHANGES

Old Terminology	New Terminology	Description
Master	Host	<ul style="list-style-type: none"> • Section 1.0 “Device Overview” was updated with the new terminology. • Section 6.0 “ASCII Command API” was updated with the new terminology.

Revision D (June 2022)

This revision includes the following changes:

TABLE D-1: MAJOR SECTION UPDATES

Section	Update Description
Section 8.9 “UKCA (UK Conformity Assessed)”	Added UKCA regulatory approval information.
Section 8.10 “China”	Added SRRC regulatory approval information.

Revision E (October 2022)

This revision includes update to Bluetooth® version of the module.

RN4020

NOTES:

THE MICROCHIP WEB SITE

Microchip provides online support via our WWW site at www.microchip.com. This web site is used as a means to make files and information easily available to customers. Accessible by using your favorite Internet browser, the web site contains the following information:

- **Product Support** – Data sheets and errata, application notes and sample programs, design resources, user's guides and hardware support documents, latest software releases and archived software
- **General Technical Support** – Frequently Asked Questions (FAQ), technical support requests, online discussion groups, Microchip consultant program member listing
- **Business of Microchip** – Product selector and ordering guides, latest Microchip press releases, listing of seminars and events, listings of Microchip sales offices, distributors and factory representatives

CUSTOMER CHANGE NOTIFICATION SERVICE

Microchip's customer notification service helps keep customers current on Microchip products. Subscribers will receive e-mail notification whenever there are changes, updates, revisions or errata related to a specified product family or development tool of interest.

To register, access the Microchip web site at www.microchip.com. Under "Support", click on "Customer Change Notification" and follow the registration instructions.

CUSTOMER SUPPORT

Users of Microchip products can receive assistance through several channels:

- Distributor or Representative
- Local Sales Office
- Field Application Engineer (FAE)
- Technical Support

Customers should contact their distributor, representative or Field Application Engineer (FAE) for support. Local sales offices are also available to help customers. A listing of sales offices and locations is included in the back of this document.

Technical support is available through the web site at: <http://microchip.com/support>

RN4020

NOTES:

Note the following details of the code protection feature on Microchip products:

- Microchip products meet the specifications contained in their particular Microchip Data Sheet.
- Microchip believes that its family of products is secure when used in the intended manner, within operating specifications, and under normal conditions.
- Microchip values and aggressively protects its intellectual property rights. Attempts to breach the code protection features of Microchip product is strictly prohibited and may violate the Digital Millennium Copyright Act.
- Neither Microchip nor any other semiconductor manufacturer can guarantee the security of its code. Code protection does not mean that we are guaranteeing the product is "unbreakable" Code protection is constantly evolving. Microchip is committed to continuously improving the code protection features of our products.

This publication and the information herein may be used only with Microchip products, including to design, test, and integrate Microchip products with your application. Use of this information in any other manner violates these terms. Information regarding device applications is provided only for your convenience and may be superseded by updates. It is your responsibility to ensure that your application meets with your specifications. Contact your local Microchip sales office for additional support or, obtain additional support at <https://www.microchip.com/en-us/support/design-help/client-support-services>.

THIS INFORMATION IS PROVIDED BY MICROCHIP "AS IS". MICROCHIP MAKES NO REPRESENTATIONS OR WARRANTIES OF ANY KIND WHETHER EXPRESS OR IMPLIED, WRITTEN OR ORAL, STATUTORY OR OTHERWISE, RELATED TO THE INFORMATION INCLUDING BUT NOT LIMITED TO ANY IMPLIED WARRANTIES OF NON-INFRINGEMENT, MERCHANTABILITY, AND FITNESS FOR A PARTICULAR PURPOSE, OR WARRANTIES RELATED TO ITS CONDITION, QUALITY, OR PERFORMANCE.

IN NO EVENT WILL MICROCHIP BE LIABLE FOR ANY INDIRECT, SPECIAL, PUNITIVE, INCIDENTAL, OR CONSEQUENTIAL LOSS, DAMAGE, COST, OR EXPENSE OF ANY KIND WHATSOEVER RELATED TO THE INFORMATION OR ITS USE, HOWEVER CAUSED, EVEN IF MICROCHIP HAS BEEN ADVISED OF THE POSSIBILITY OR THE DAMAGES ARE FORESEEABLE. TO THE FULLEST EXTENT ALLOWED BY LAW, MICROCHIP'S TOTAL LIABILITY ON ALL CLAIMS IN ANY WAY RELATED TO THE INFORMATION OR ITS USE WILL NOT EXCEED THE AMOUNT OF FEES, IF ANY, THAT YOU HAVE PAID DIRECTLY TO MICROCHIP FOR THE INFORMATION.

Use of Microchip devices in life support and/or safety applications is entirely at the buyer's risk, and the buyer agrees to defend, indemnify and hold harmless Microchip from any and all damages, claims, suits, or expenses resulting from such use. No licenses are conveyed, implicitly or otherwise, under any Microchip intellectual property rights unless otherwise stated.

For information regarding Microchip's Quality Management Systems, please visit www.microchip.com/quality.

Trademarks

The Microchip name and logo, the Microchip logo, Adaptec, AVR, AVR logo, AVR Freaks, BesTime, BitCloud, CryptoMemory, CryptoRF, dsPIC, flexPWR, HELDO, IGLoo, JukeBlox, KeeLoq, Klear, LANCheck, LinkMD, maXStylus, maXTouch, MediaLB, megaAVR, Microsemi, Microsemi logo, MOST, MOST logo, MPLAB, OptoLyzer, PIC, picoPower, PICSTART, PIC32 logo, PolarFire, Prochip Designer, QTouch, SAM-BA, SenGenuity, SpyNIC, SST, SST Logo, SuperFlash, Symmetricom, SyncServer, Tachyon, TimeSource, tinyAVR, UNI/O, Vectron, and XMEGA are registered trademarks of Microchip Technology Incorporated in the U.S.A. and other countries.

AgileSwitch, APT, ClockWorks, The Embedded Control Solutions Company, EtherSynch, Flashtec, Hyper Speed Control, HyperLight Load, Libero, motorBench, mTouch, Powermite 3, Precision Edge, ProASIC, ProASIC Plus, ProASIC Plus logo, Quiet-Wire, SmartFusion, SyncWorld, Temux, TimeCesium, TimeHub, TimePictra, TimeProvider, TrueTime, and ZL are registered trademarks of Microchip Technology Incorporated in the U.S.A.

Adjacent Key Suppression, AKS, Analog-for-the-Digital Age, Any Capacitor, AnyIn, AnyOut, Augmented Switching, BlueSky, BodyCom, Clockstudio, CodeGuard, CryptoAuthentication, CryptoAutomotive, CryptoCompanion, CryptoController, dsPICDEM, dsPICDEM.net, Dynamic Average Matching, DAM, ECAN, Espresso T1S, EtherGREEN, GridTime, IdealBridge, In-Circuit Serial Programming, ICSP, INICnet, Intelligent Paralleling, IntelliMOS, Inter-Chip Connectivity, JitterBlocker, Knob-on-Display, KoD, maxCrypto, maxView, memBrain, Mindi, MiWi, MPASM, MPF, MPLAB Certified logo, MPLIB, MPLINK, MultiTRAK, NetDetach, Omniscient Code Generation, PICDEM, PICDEM.net, PICkit, PICtail, PowerSmart, PureSilicon, QMatrix, REAL ICE, Ripple Blocker, RTAX, RTG4, SAM-ICE, Serial Quad I/O, simpleMAP, SimpliPHY, SmartBuffer, SmartHLS, SMART-I.S., storClad, SQI, SuperSwitcher, SuperSwitcher II, Switchtec, SynchroPHY, Total Endurance, Trusted Time, TSHARC, USBCheck, VariSense, VectorBlox, VeriPHY, ViewSpan, WiperLock, XpressConnect, and ZENA are trademarks of Microchip Technology Incorporated in the U.S.A. and other countries.

SQTP is a service mark of Microchip Technology Incorporated in the U.S.A.

The Adaptec logo, Frequency on Demand, Silicon Storage Technology, and Symmcom are registered trademarks of Microchip Technology Inc. in other countries.

GestIC is a registered trademark of Microchip Technology Germany II GmbH & Co. KG, a subsidiary of Microchip Technology Inc., in other countries.

All other trademarks mentioned herein are property of their respective companies.

© 2014-2022, Microchip Technology Incorporated and its subsidiaries.

All Rights Reserved.

ISBN: 978-1-6683-1336-7



MICROCHIP

Worldwide Sales and Service

AMERICAS

Corporate Office
2355 West Chandler Blvd.
Chandler, AZ 85224-6199
Tel: 480-792-7200
Fax: 480-792-7277
Technical Support:
<http://www.microchip.com/support>
Web Address:
www.microchip.com

Atlanta

Duluth, GA
Tel: 678-957-9614
Fax: 678-957-1455

Austin, TX

Tel: 512-257-3370

Boston

Westborough, MA
Tel: 774-760-0087
Fax: 774-760-0088

Chicago

Itasca, IL
Tel: 630-285-0071
Fax: 630-285-0075

Dallas

Addison, TX
Tel: 972-818-7423
Fax: 972-818-2924

Detroit

Novi, MI
Tel: 248-848-4000

Houston, TX

Tel: 281-894-5983

Indianapolis

Noblesville, IN
Tel: 317-773-8323
Fax: 317-773-5453
Tel: 317-536-2380

Los Angeles

Mission Viejo, CA
Tel: 949-462-9523
Fax: 949-462-9608
Tel: 951-273-7800

Raleigh, NC

Tel: 919-844-7510

New York, NY

Tel: 631-435-6000

San Jose, CA

Tel: 408-735-9110
Tel: 408-436-4270

Canada - Toronto

Tel: 905-695-1980
Fax: 905-695-2078

ASIA/PACIFIC

Australia - Sydney
Tel: 61-2-9868-6733

China - Beijing
Tel: 86-10-8569-7000

China - Chengdu
Tel: 86-28-8665-5511

China - Chongqing
Tel: 86-23-8980-9588

China - Dongguan
Tel: 86-769-8702-9880

China - Guangzhou
Tel: 86-20-8755-8029

China - Hangzhou
Tel: 86-571-8792-8115

China - Hong Kong SAR
Tel: 852-2943-5100

China - Nanjing
Tel: 86-25-8473-2460

China - Qingdao
Tel: 86-532-8502-7355

China - Shanghai
Tel: 86-21-3326-8000

China - Shenyang
Tel: 86-24-2334-2829

China - Shenzhen
Tel: 86-755-8864-2200

China - Suzhou
Tel: 86-186-6233-1526

China - Wuhan
Tel: 86-27-5980-5300

China - Xian
Tel: 86-29-8833-7252

China - Xiamen
Tel: 86-592-2388138

China - Zhuhai
Tel: 86-756-3210040

ASIA/PACIFIC

India - Bangalore
Tel: 91-80-3090-4444

India - New Delhi
Tel: 91-11-4160-8631

India - Pune
Tel: 91-20-4121-0141

Japan - Osaka
Tel: 81-6-6152-7160

Japan - Tokyo
Tel: 81-3-6880-3770

Korea - Daegu
Tel: 82-53-744-4301

Korea - Seoul
Tel: 82-2-554-7200

Malaysia - Kuala Lumpur
Tel: 60-3-7651-7906

Malaysia - Penang
Tel: 60-4-227-8870

Philippines - Manila
Tel: 63-2-634-9065

Singapore
Tel: 65-6334-8870

Taiwan - Hsin Chu
Tel: 886-3-577-8366

Taiwan - Kaohsiung
Tel: 886-7-213-7830

Taiwan - Taipei
Tel: 886-2-2508-8600

Thailand - Bangkok
Tel: 66-2-694-1351

Vietnam - Ho Chi Minh
Tel: 84-28-5448-2100

EUROPE

Austria - Wels
Tel: 43-7242-2244-39
Fax: 43-7242-2244-393

Denmark - Copenhagen
Tel: 45-4485-5910
Fax: 45-4485-2829

Finland - Espoo
Tel: 358-9-4520-820

France - Paris
Tel: 33-1-69-53-63-20
Fax: 33-1-69-30-90-79

Germany - Garching
Tel: 49-8931-9700

Germany - Haan
Tel: 49-2129-3766400

Germany - Heilbronn
Tel: 49-7131-72400

Germany - Karlsruhe
Tel: 49-721-625370

Germany - Munich
Tel: 49-89-627-144-0
Fax: 49-89-627-144-44

Germany - Rosenheim
Tel: 49-8031-354-560

Israel - Ra'anana
Tel: 972-9-744-7705

Italy - Milan
Tel: 39-0331-742611
Fax: 39-0331-466781

Italy - Padova
Tel: 39-049-7625286

Netherlands - Drunen
Tel: 31-416-690399
Fax: 31-416-690340

Norway - Trondheim
Tel: 47-7288-4388

Poland - Warsaw
Tel: 48-22-3325737

Romania - Bucharest
Tel: 40-21-407-87-50

Spain - Madrid
Tel: 34-91-708-08-90
Fax: 34-91-708-08-91

Sweden - Gothenberg
Tel: 46-31-704-60-40

Sweden - Stockholm
Tel: 46-8-5090-4654

UK - Wokingham
Tel: 44-118-921-5800
Fax: 44-118-921-5820