

ANT-8/9-FPC-UFL-100

Flexible Embedded LPWA 868/915 MHz Antenna

The 8/9-FPC antenna is a flexible embedded multiband antenna designed for use in 868 MHz and 915 MHz frequency bands for low-power, wide-area (LPWA) applications such as LoRaWAN®, Sigfox® and WiFi HaLow™ as well as other ISM and remote control applications. The 8/9-FPC provides a ground plane independent dipole embedded antenna solution comparable in performance to an external antenna. The 8/9-FPC's flexibility and adhesive backing makes it easy to mount in unique and custom enclosures, while enabling an environmentally sealed enclosure and protection from tampering or accidental antenna damage.

Connection is made to the radio via a 100 mm long, 1.13 mm coaxial cable terminated in a U.FL-type plug (female socket).

FEATURES

- Performance at 902 MHz to 930 MHz
 - VSWR: ≤ 1.6
 - Peak Gain: -7.4 dBi
 - Efficiency: 19%
- Ground plane independent dipole antenna
- Compact, low-profile
 - 39.0 mm x 15.0 mm x 0.2 mm
- U.FL-type plug (female socket) Compatible with MHF1, AMC, UMCC
- Flexible to fit in challenging enclosures
- Adhesive backing permanently adheres to non-metal enclosures using 3M 300LSE™ adhesive

APPLICATIONS

- Low-power, wide-area (LPWA) applications
 - LoRaWAN®
 - Sigfox®
 - WiFi HaLow™ (802.11ah)
- Remote control, monitoring and sensing
- Internet of Things (IoT) devices
- ISM applications

ORDERING INFORMATION

Part Number	Description
ANT-8/9-FPC-UFL-100	LPWA antenna with 100 mm of 1.13 mm coaxial cable and U.FL-type plug (female socket)

Available from Linx Technologies and select distributors and representatives.

TABLE 1. ELECTRICAL SPECIFICATIONS

ANT-8/9-IPW1-SMA	868 MHz	915 MHz
Frequency Range	862 MHz to 876 MHz	902 MHz to 930 MHz
VSWR (max.)	2.0	1.6
Peak Gain (dBi)	-3.2	-3.0
Average Gain (dBi)	-8.4	-7.4
Efficiency (%)	15	19
Polarization	Linear	
Radiation	Omnidirectional	
Max Power	2 W	
Wavelength	1/2-wave	
Electrical Type	Dipole	
Impedance	50 Ω	
Connection	U.FL-type plug (female socket) on 100 mm (3.94 in) of 1.13 mm coaxial cable.	
Weight	0.6 g (0.02 oz)	
Dimensions	39.0 mm x 15.0 mm x 0.2 mm (1.54 in x 0.59 in x 0.01 in)	
Operating Temp. Range	-40 °C to +85 °C	

PRODUCT DIMENSIONS

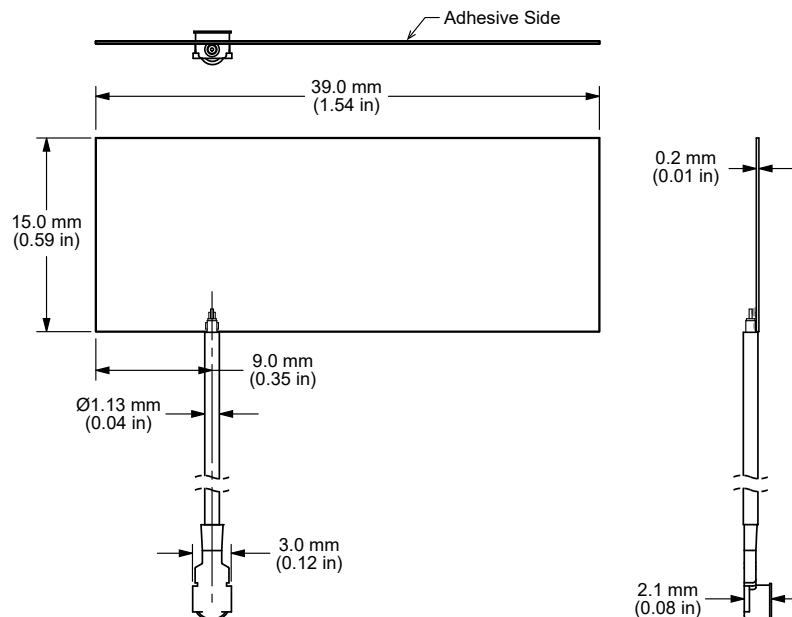

Figure 1: ANT-8/9-FPC-UFL Dimensions

ANTENNA MOUNTING

The ANT-8/9-FPC-UFL-100 is a flexible, adhesive backed antenna that allows it to be permanently installed onto non-metallic surfaces. The adhesive backing is 3M 300LSE™, which provides excellent adhesion to high and low surface energy plastics. 3M 300LSE™ adhesive is resistant to solvents, humidity and moisture, as well as heat up to 121 °C (250 °F) for short periods.

The antenna should never be bent to the point of creating a crease or allowing the angle of the bend to fall below 90 degrees (i.e. become acute) as this will impair function and may cause permanent damage.

VSWR

Figure 2 provides the voltage standing wave ratio (VSWR) across the antenna bandwidth. VSWR describes the power reflected from the antenna back to the radio. A lower VSWR value indicates better antenna performance at a given frequency. Reflected power is also shown on the right-side vertical axis as a gauge of the percentage of transmitter power reflected back from the antenna.

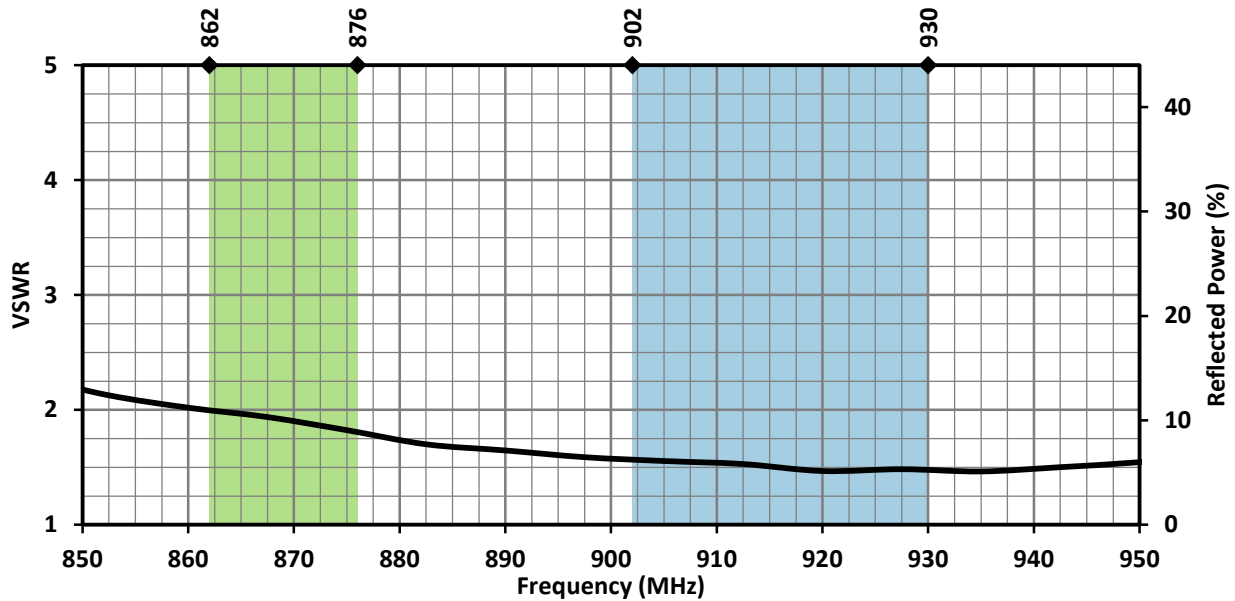

Figure 2. 8/9-FPC Antenna VSWR with Frequency Band Highlights

RETURN LOSS

Return loss (Figure 3), represents the loss in power at the antenna due to reflected signals. Like VSWR, a lower return loss value indicates better antenna performance at a given frequency.

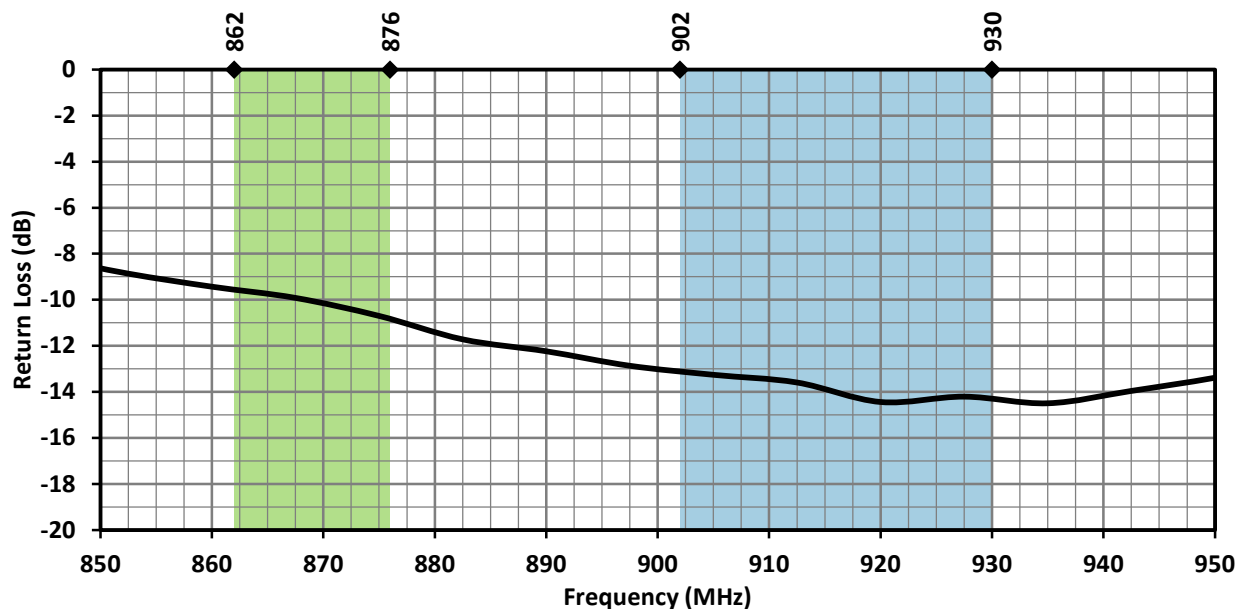

Figure 3. 8/9-FPC Antenna Return Loss with Frequency Band Highlights

PEAK GAIN

The peak gain across the antenna bandwidth is shown in Figure 4. Peak gain represents the maximum antenna input power concentration across 3-dimensional space, and therefore peak performance, at a given frequency, but does not consider any directionality in the gain pattern.

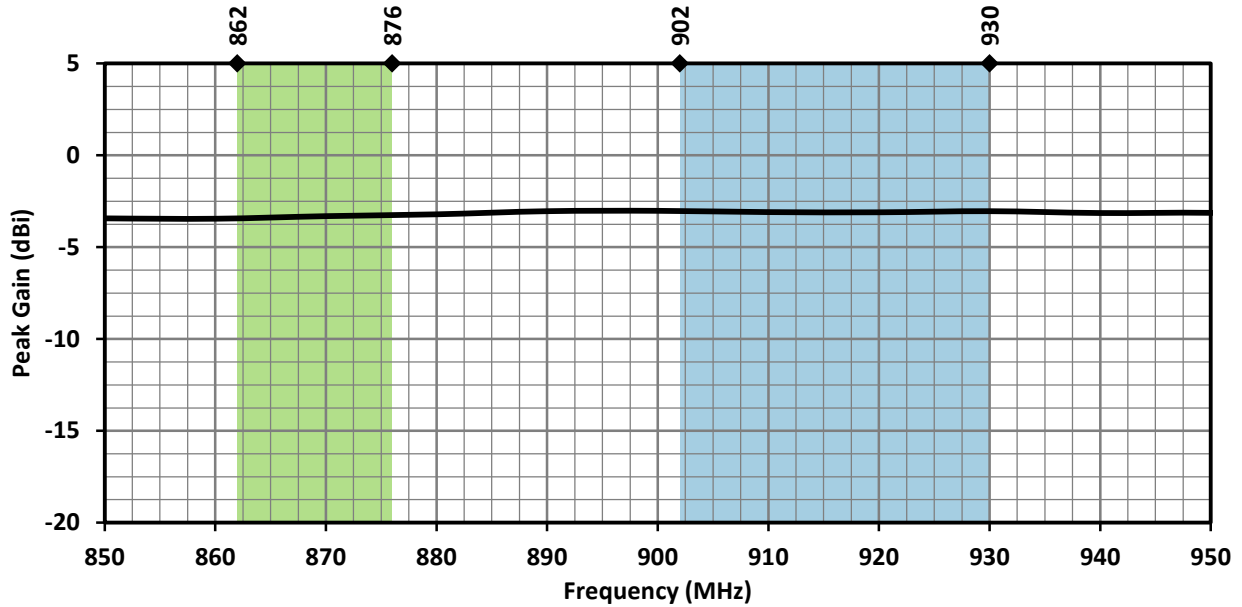

Figure 4. 8/9-FPC Antenna Peak Gain with Frequency Band Highlights

AVERAGE GAIN

Average gain (Figure 5), is the average of all antenna gain in 3-dimensional space at each frequency, providing an indication of overall performance without expressing antenna directionality.

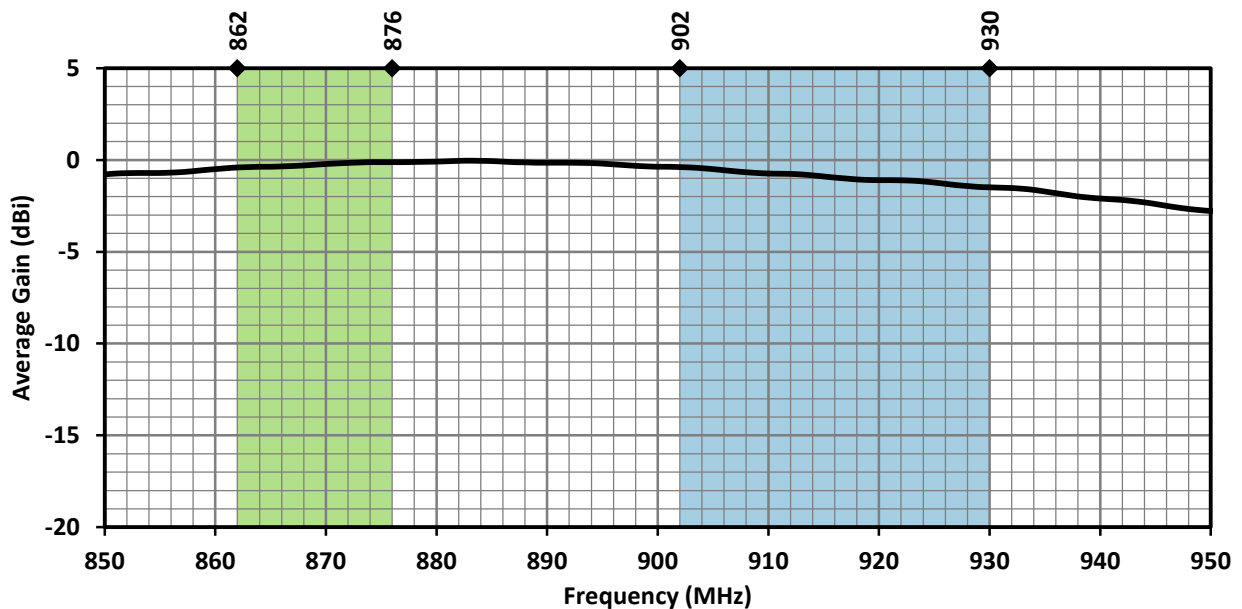

Figure 5. 8/9-FPC Antenna Average Gain with Frequency Band Highlights

RADIATION EFFICIENCY

Radiation efficiency (Figure 6), shows the ratio of power delivered to the antenna relative to the power radiated at the antenna, expressed as a percentage, where a higher percentage indicates better performance at a given frequency.

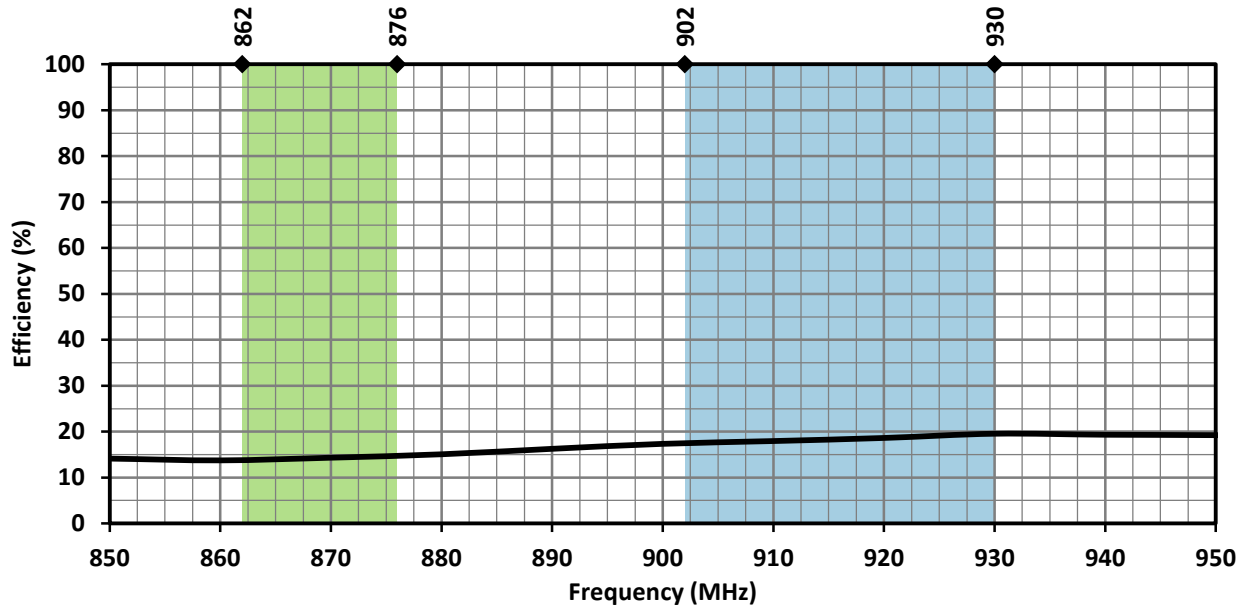
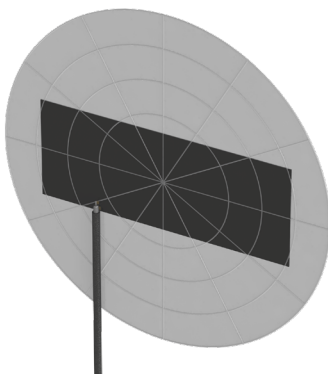

Figure 6. 8/9-FPC Antenna Radiation Efficiency with Frequency Band Highlights

RADIATION PATTERNS

Radiation patterns provide information about the directionality and 3-dimensional gain performance of the antenna by plotting gain at specific frequencies in three orthogonal planes. Antenna radiation patterns (Figure 7), are shown using polar plots covering 360 degrees. The antenna graphic above the plots provides reference to the plane of the column of plots below it. Note: when viewed with typical PDF viewing software, zooming into radiation patterns is possible to reveal fine detail.

RADIATION PATTERNS - EDGE OF GROUND PLANE



XZ-Plane Gain

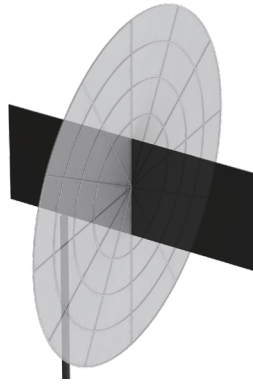

YZ-Plane Gain

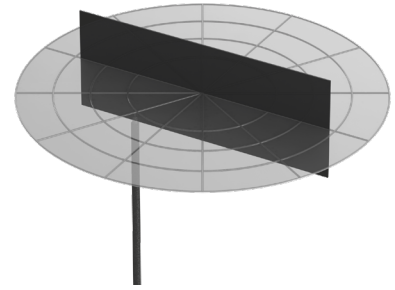

XY-Plane Gain

862 MHz TO 876 MHz (868 MHz)

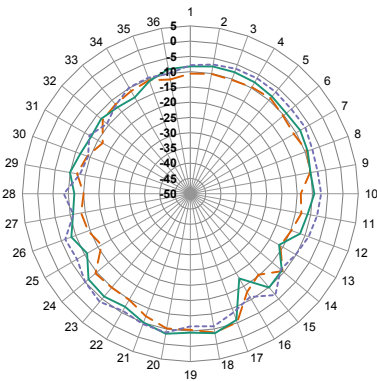

XZ-Plane Gain

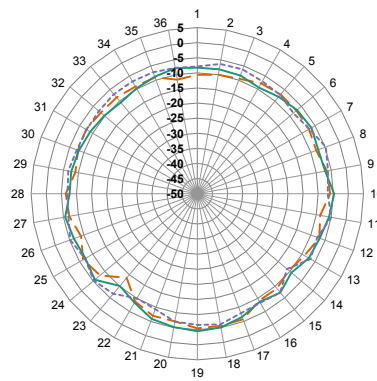

YZ-Plane Gain

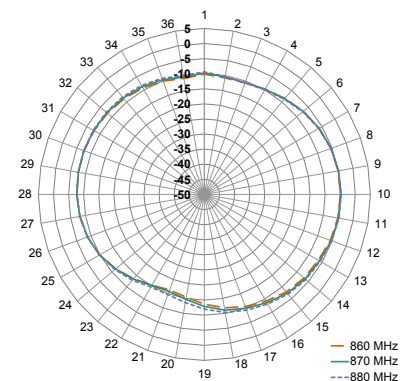

XY-Plane Gain

902 MHz TO 930 MHz (915 MHz)

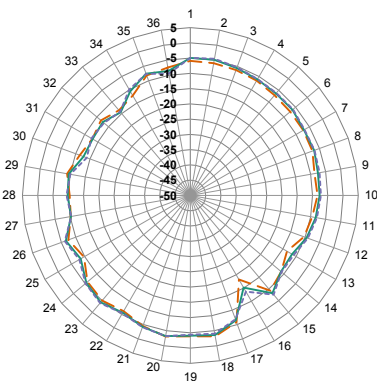

XZ-Plane Gain

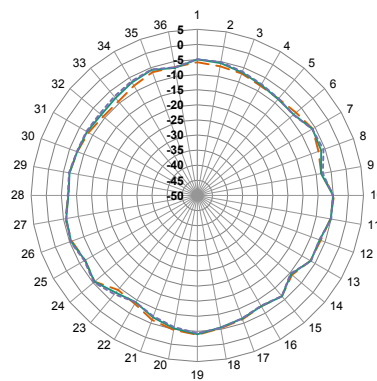

YZ-Plane Gain

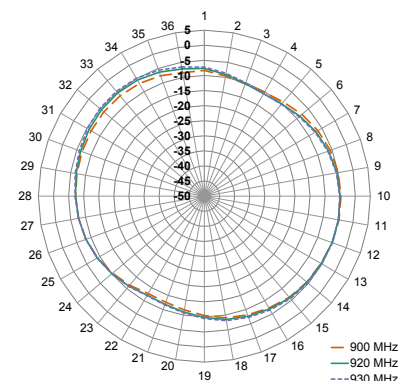

XY-Plane Gain

Figure 7. Radiation Patterns for ANT-8/9-FPC-UFL-100 Antenna

LPWA: LORAWAN® AND SIGFOX®

LoRaWAN and Sigfox LPWA technologies operate within several of the frequencies supported by the 8/9-FPC-UFL antenna. Notably, LoRaWAN operates at the frequency bands shown in Figure 8. Sigfox operates at different frequencies determined by country (Figure 9).

Frequency Band	LoRaWAN Channel Plan
779 MHz to 787 MHz	CN779-787
865 MHz to 867 MHz	IN765-867
868 MHz to 873 MHz	EU863-870
902 MHz to 928 MHz	US902-928, AS923
915 MHz to 928 MHz	AU915-928
917 MHz to 923.5 MHz	KR920-923

Figure 8. LoRaWAN® Channel plan

Center Frequency	Select Countries/Regions
868 MHz	Europe
902 MHz	USA, Mexico, Brazil
920 MHz	Australia
923 MHz	Japan

Figure 9. Sigfox® Frequencies by Country/Region

PACKAGING INFORMATION

The ANT-8/9-FPC-UFL-100 antennas are individually sealed in a clear plastic sleeve. Individual sleeves are packed in a bags of 100 pcs. Distribution channels may offer alternative packaging options.

TE TECHNICAL SUPPORT CENTER

USA:	+1 (800) 522-6752
Canada:	+1 (905) 475-6222
Mexico:	+52 (0) 55-1106-0800
Latin/S. America:	+54 (0) 11-4733-2200
Germany:	+49 (0) 6251-133-1999
UK:	+44 (0) 800-267666
France:	+33 (0) 1-3420-8686
Netherlands:	+31 (0) 73-6246-999
China:	+86 (0) 400-820-6015

te.com

TE Connectivity, TE, TE connectivity (logo), Linx and Linx Technologies are trademarks owned or licensed by the TE Connectivity Ltd. family of companies. All other logos, products and/or company names referred to herein might be trademarks of their respective owners.

The information given herein, including drawings, illustrations and schematics which are intended for illustration purposes only, is believed to be reliable. However, TE Connectivity makes no warranties as to its accuracy or completeness and disclaims any liability in connection with its use. TE Connectivity's obligations shall only be as set forth in TE Connectivity's Standard Terms and Conditions of Sale for this product and in no case will TE Connectivity be liable for any incidental, indirect or consequential damages arising out of the sale, resale, use or misuse of the product. Users of TE Connectivity products should make their own evaluation to determine the suitability of each such product for the specific application.

TE Connectivity warrants to the original end user customer of its products that its products are free from defects in material and workmanship. Subject to conditions and limitations TE Connectivity will, at its option, either repair or replace any part of its products that prove defective because of improper workmanship or materials. This limited warranty is in force for the useful lifetime of the original end product into which the TE Connectivity product is installed. Useful lifetime of the original end product may vary but is not warranted to exceed one (1) year from the original date of the end product purchase.

©2022 TE Connectivity. All Rights Reserved.

09/22 Original