



nanoSplatch™ nSP250

Embedded WiFi/ WLAN Antenna

The nanoSplatch™ nSP250 is a surface-mount antenna for embedded WiFi/WLAN and other 2.4 GHz or 5 GHz ISM or U-NII frequency band applications. It uses a grounded-line technique to achieve outstanding performance in a tiny surface-mount package. The nSP250 exhibits low proximity effect with a very hemispherical radiation pattern, making it ideal for handheld devices and applications typically subject to interference.

The nSP250 is available in tape and reel packaging and is designed for reflow-solder mounting directly to a printed circuit board for high-volume applications.

FEATURES

- Performance at 2.4 GHz to 2.485 GHz
 - VSWR: ≤ 2.0
 - Peak Gain: 2.7 dBi
 - Efficiency: 65%
- Performance at 5.725 GHz to 5.875 GHz
 - VSWR: ≤ 2.4
 - Peak Gain: 3.7 dBi
 - Efficiency: 70%
- Ultra-compact package (9.6 mm x 8.4 mm x 1.1 mm)
- Excellent performance with smallest ground plane (40 mm x 20 mm)
- Resistant to proximity effect
- Omnidirectional radiation pattern
- Direct surface-mount PCB attachment
- Reflow- or hand-solder assembly

APPLICATIONS

- Single- and dual-band WiFi/WLAN/802.11
 - WiFi 6 (802.11ax)
 - WiFi 5 (802.11ac)
 - WiFi 4 (802.11n)
- Bluetooth® and ZigBee®
- Smart Home networking
- Sensing and remote monitoring
- Hand-held devices
- Internet of Things (IoT) devices
- U-NII and ISM applications

ORDERING INFORMATION

Part Number	Description
ANT-DB1-nSP250-T	Surface mount WiFi/WLAN antenna
AEK-DB1-nSP250	Surface mount WiFi/WLAN antenna evaluation kit

Available from Linx Technologies and select distributors and representatives.

TABLE 1. ELECTRICAL SPECIFICATIONS

Band	2.4 GHz ISM	U-NII	5 GHz ISM/ U-NII-3
Frequency Range	2.4 GHz to 2.5 GHz	5.150 GHz to 5.725 GHz	5.725 GHz to 5.875 GHz
VSWR (max)	2.0	2.2	2.4
Peak Gain (dBi)	2.7	4.3	3.7
Average Gain (dBi)	-1.8	-1.9	-1.6
Efficiency (%)	65	60	70
Impedance	50 Ω		
Polarization	Linear		
Radiation	Omnidirectional		
Max Power	5 W		
Wavelength	1/4-wave		
Electrical Type	Monopole		
ESD Sensitivity	NOT ESD sensitive. As a best practice, Linx may use ESD packaging.		

Electrical specifications and plots measured with a 40 mm x 20 mm (1.6 in x 0.8 in) reference ground plane.

TABLE 2. MECHANICAL SPECIFICATIONS

Parameter	Value
Connection	Surface-mount
Dimensions	9.6 mm x 8.4 mm x 1.1 mm (0.38 in x 0.33 in x 0.04 in)
Weight	0.16 g (0.006 oz)
Operating Temp. Range	-40 °C to +130 °C

PRODUCT DIMENSIONS

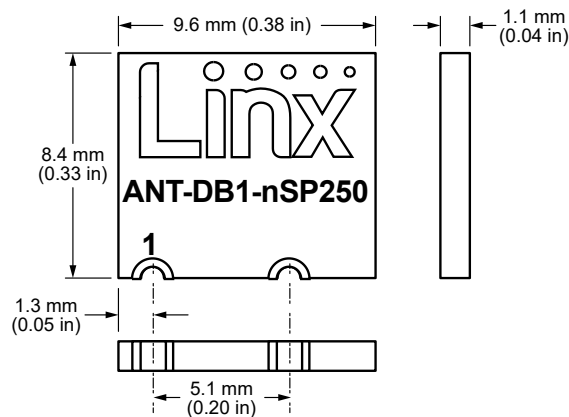

Figure 1. ANT-DB1-nSP250 Antenna Dimensions

PRODUCT SIGNALS

The signal definitions for the ANT-DB1-nSP250 antenna are provided in Table 3.

Function	Description
Rx/Tx	Castellation marked as “1”
GND	Unmarked castellation

Table 3. ANT-DB1-nSP250 Antenna Pin-Out Table

VSWR

Figure 2 provides the voltage standing wave ratio (VSWR) across the antenna bandwidth. VSWR describes the power reflected from the antenna back to the radio. A lower VSWR value indicates better antenna performance at a given frequency. Reflected power is also shown on the right-side vertical axis as a gauge of the percentage of transmitter power reflected back from the antenna.

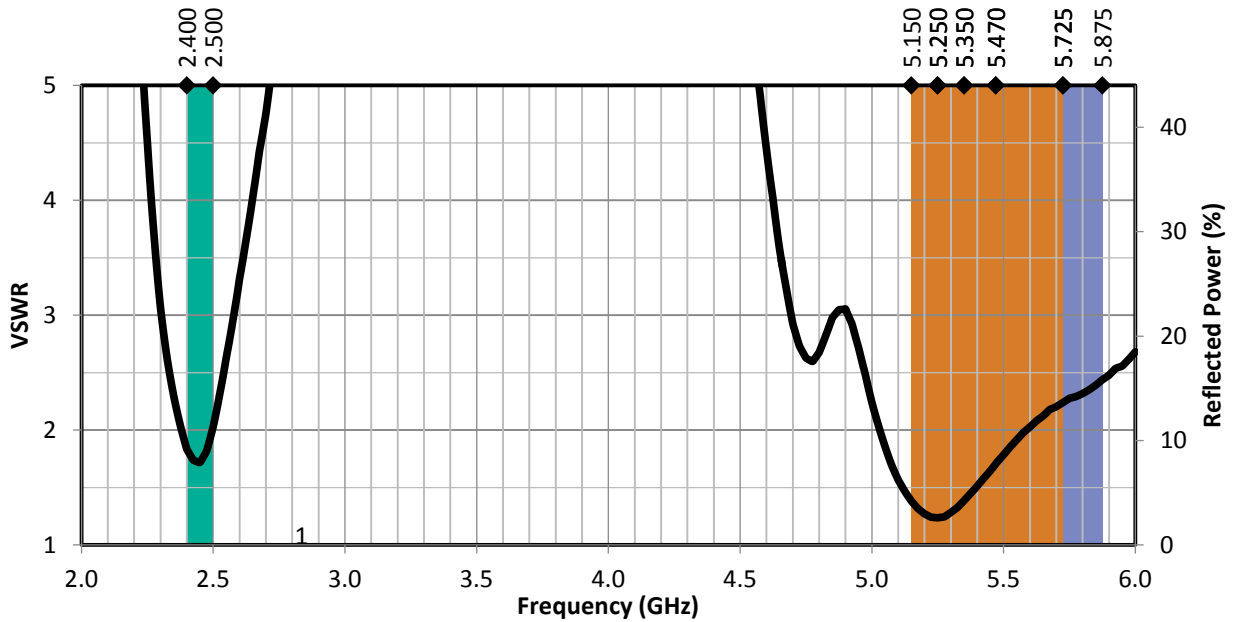

Figure 2. ANT-DB1-nSP250 Antenna VSWR with Frequency Band Highlights

RETURN LOSS

Return loss (Figure 3), represents the loss in power at the antenna due to reflected signals. Like VSWR, a lower return loss value indicates better antenna performance at a given frequency.

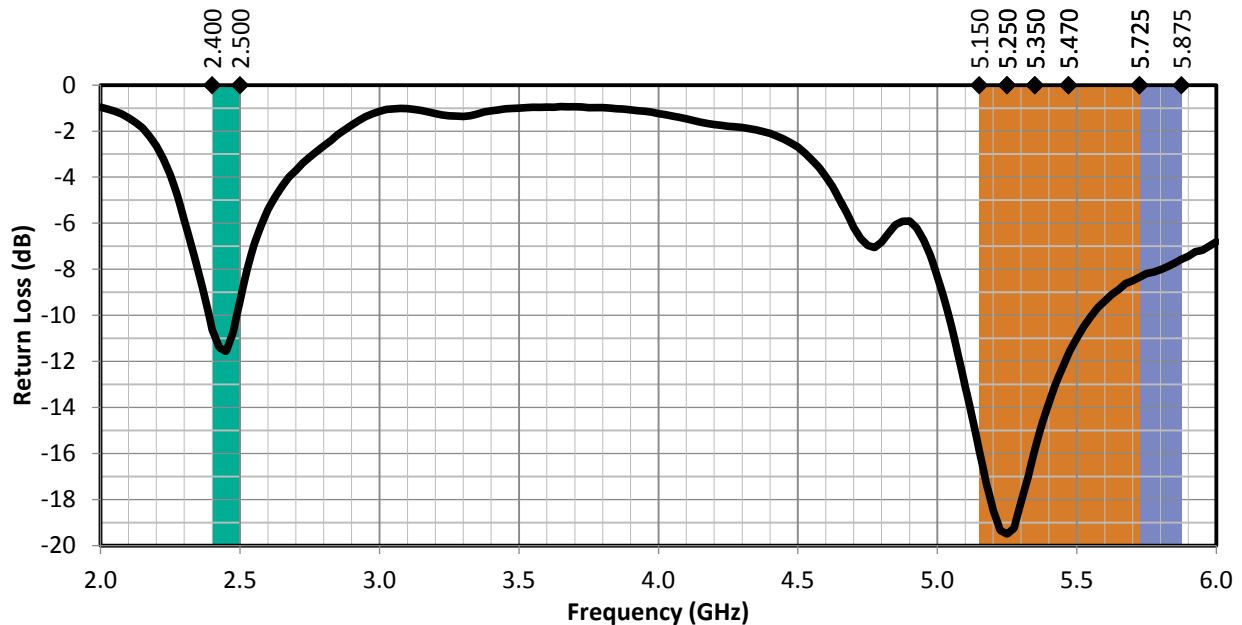

Figure 3. ANT-DB1-nSP250 Return Loss with Frequency Band Highlights

PEAK GAIN

The peak gain across the antenna bandwidth is shown in Figure 4. Peak gain represents the maximum antenna input power concentration across 3-dimensional space, and therefore peak performance at a given frequency, but does not consider any directionality in the gain pattern.

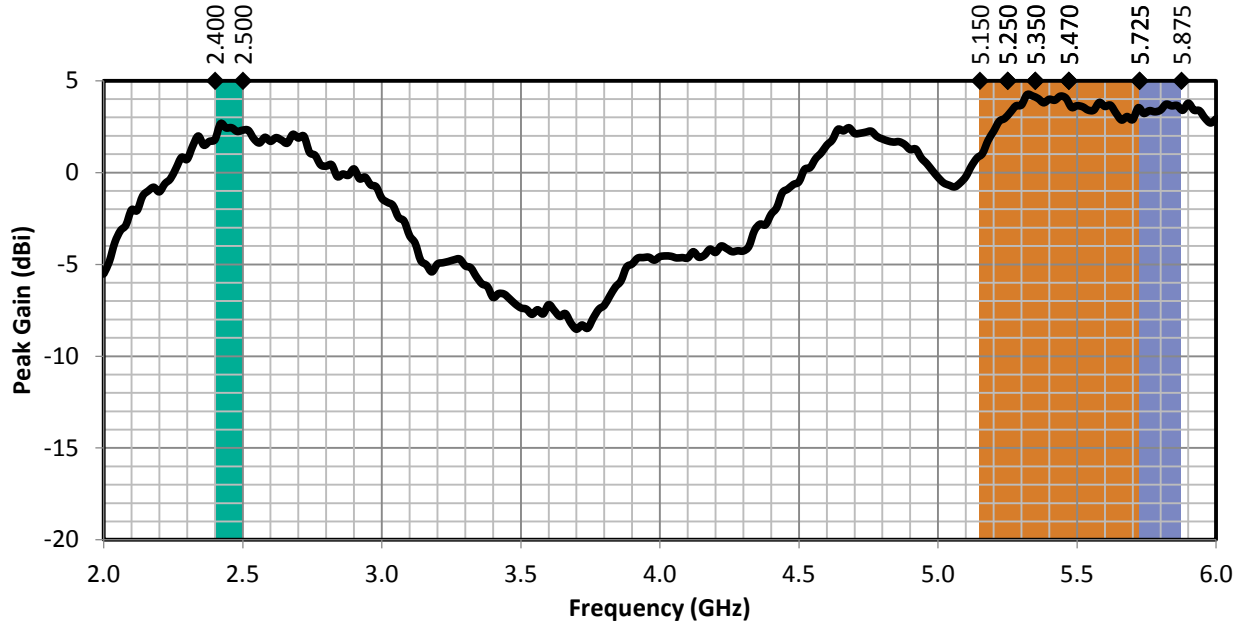

Figure 4. ANT-DB1-nSP250 Antenna Peak Gain with Frequency Band Highlights

AVERAGE GAIN

Average gain (Figure 5), is the average of all antenna gain in 3-dimensional space at each frequency, providing an indication of overall performance without expressing antenna directionality.

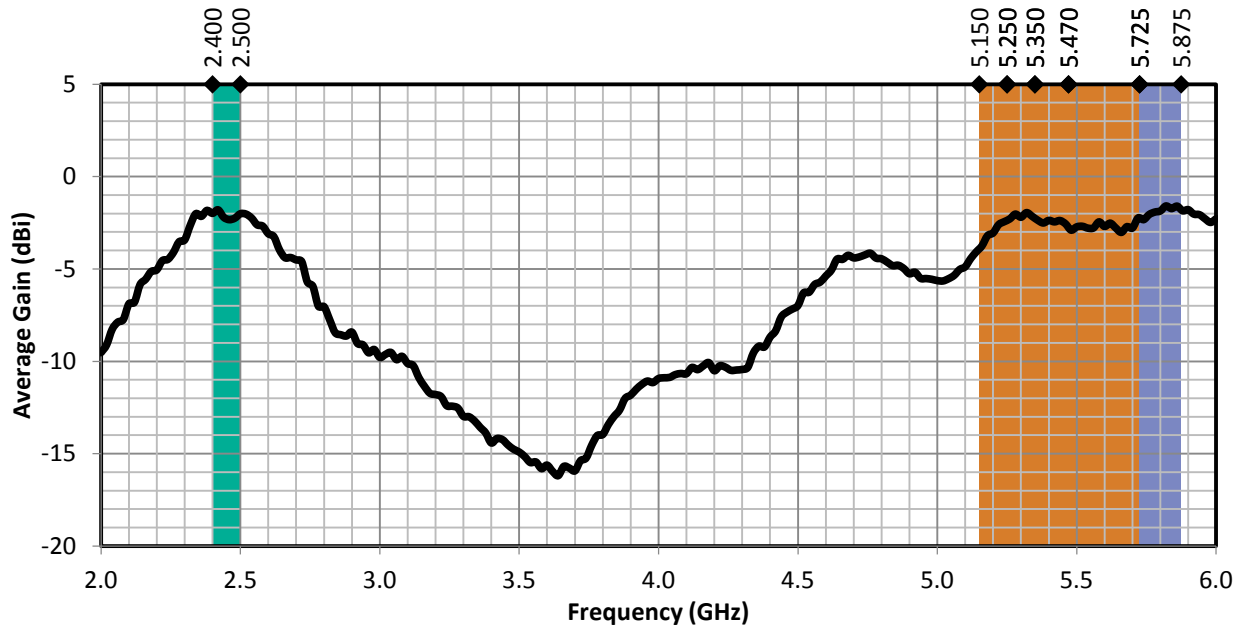

Figure 5. ANT-DB1-nSP250 Average Gain with Frequency Band Highlights

RADIATION EFFICIENCY

Radiation efficiency (Figure 6), shows the ratio of power delivered to the antenna relative to the power radiated at the antenna, expressed as a percentage, where a higher percentage indicates better performance at a given frequency.

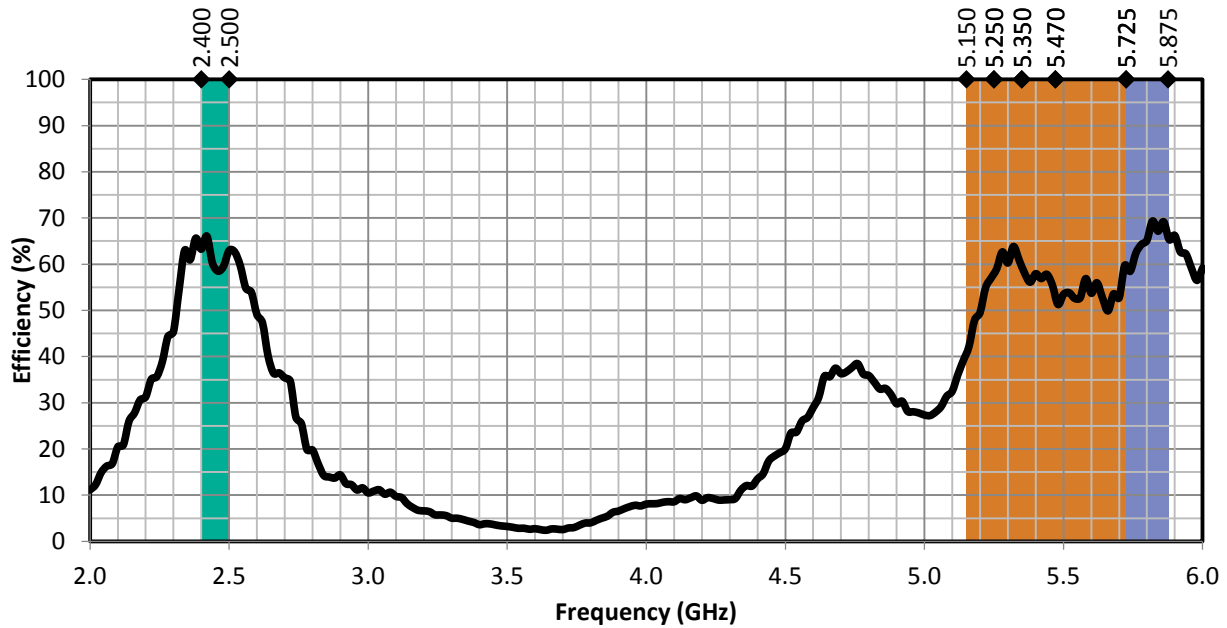

Figure 6. ANT-DB1-nSP250 Radiation Efficiency with Frequency Band Highlights

PROXIMITY EFFECT

Wireless devices are often designed based on antenna performance measured on an evaluation board. In practice, however, many wireless devices are used in the presence of materials near the antenna which were not present during evaluation. These materials, such as batteries, components on the PCB, or even a person's body or hand¹, can cause a shift in the frequency performance of the antenna, resulting in less than optimal device performance. The shift in the frequency performance can be quite dramatic, especially for monopole (1/4 wavelength) antennas.

The nSP250 antenna is designed to help reduce the impact of nearby objects on the performance of the antenna by using a grounded line technique to reduce the overall length of the antenna radiator to provide wider bandwidth for better immunity to frequency shifts, while using a multilayer PCB to maintain a lower profile and small size. Matching components can be added, if necessary, to mitigate larger proximity effects from features like metal shields or enclosures.

Notes

¹ Antenna Proximity Effects for Talk and Data Modes in Mobile Phones; M. Pelosi, et al; IEEE Antennas and Propagation Magazine, Vol. 52, Issue 3, June 2010

RADIATION PATTERNS

Radiation patterns provide information about the directionality and 3-dimensional gain performance of the antenna by plotting gain at specific frequencies in three orthogonal planes. Antenna radiation patterns (Figure 7), are shown using polar plots covering 360 degrees. The antenna graphic above the plots provides reference to the plane of the column of plots below it. Note: when viewed with typical PDF viewing software, zooming into radiation patterns is possible to reveal fine detail.

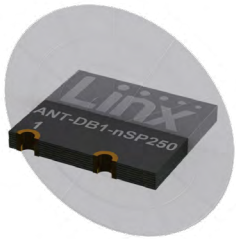

XZ-Plane Gain

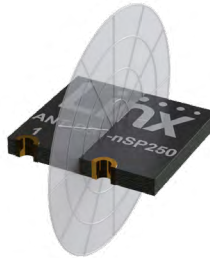

YZ-Plane Gain

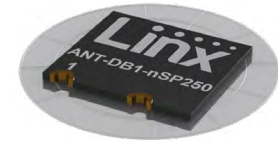

XY-Plane Gain

2.4 GHZ TO 2.5 GHZ (2.45 GHZ)

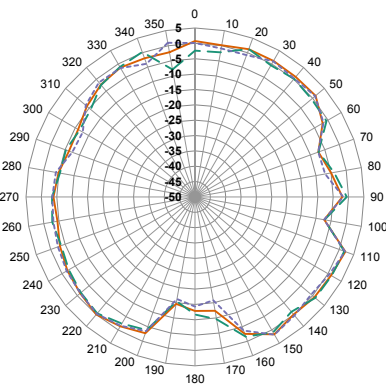

XZ-Plane Gain

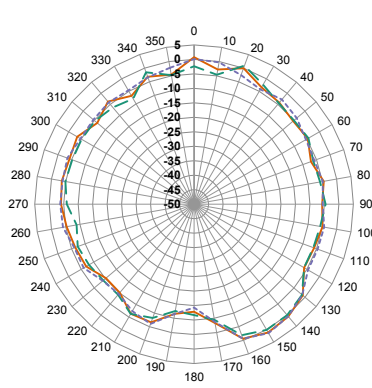

YZ-Plane Gain

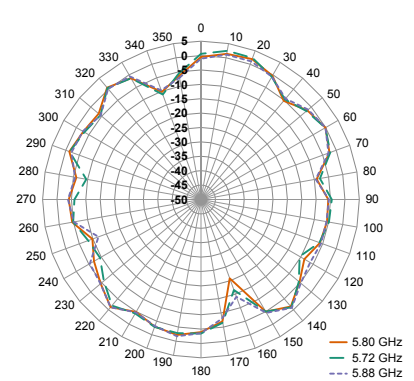

XY-Plane Gain

— 5.80 GHz
— 5.72 GHz
- - 5.88 GHz

5.15 GHZ TO 5.73 GHZ (5.43 GHZ)

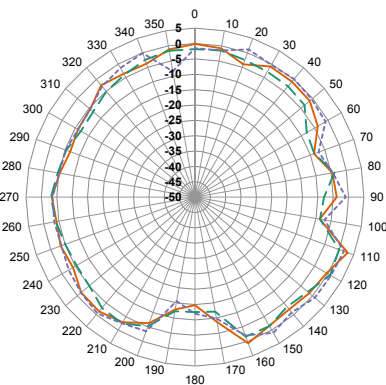

XZ-Plane Gain

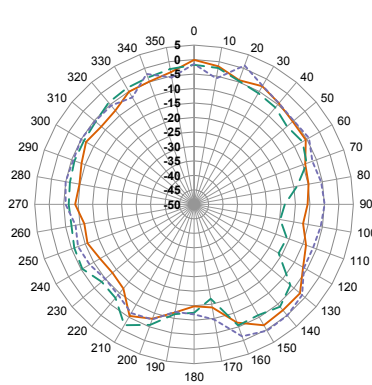

YZ-Plane Gain

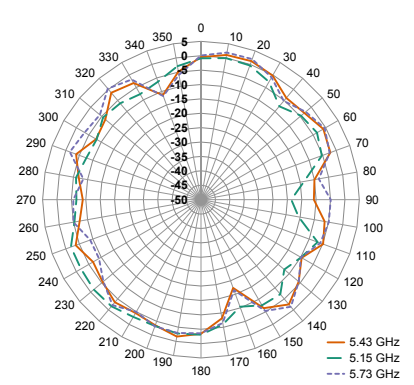

XY-Plane Gain

— 5.43 GHz
— 5.15 GHz
- - 5.73 GHz

RADIATION PATTERNS



XZ-Plane Gain

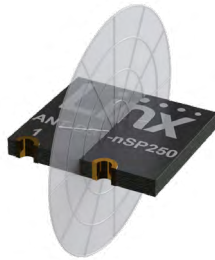

YZ-Plane Gain

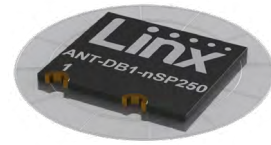

XY-Plane Gain

5.72 GHZ TO 5.88 GHZ (5.8 GHZ)

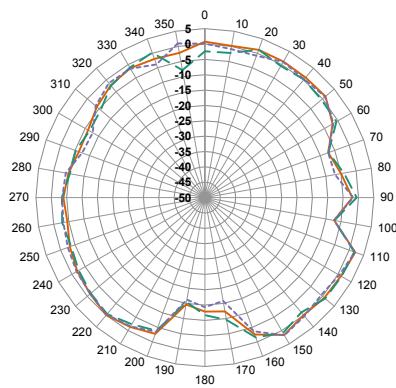

XZ-Plane Gain

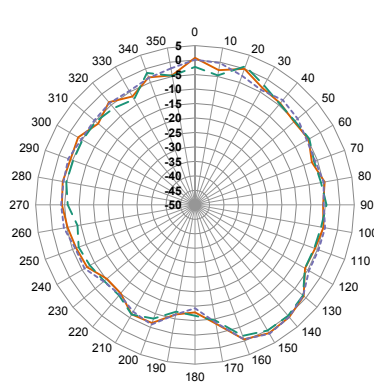

YZ-Plane Gain

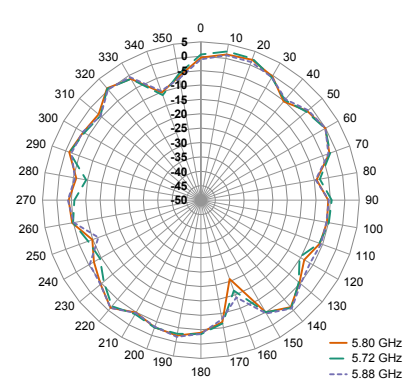

XY-Plane Gain

Figure 7. ANT-DB1-nSP250 Antenna Radiation Patterns

GROUND PLANE

The nSP250 is a 1/4-wave monopole antenna, and requires a ground plane on the PCB to which it is mounted. Linx recommends a 40 mm x 20 mm or larger ground plane. The nSP250 should be mounted at the edge of the ground plane (see Figure 8), and none of the ground plane should be underneath the antenna. Other ground plane sizes and antenna mounting locations are possible. Linx offers PCB design reviews to help optimize solution performance.

RECOMMENDED LAYOUT

The recommended printed circuit board (PCB) layout for the ANT-DB1-nSP250 is shown in Figure 8. This layout is used for the ANT-DB1-nSP250 evaluation board which is available for purchase as listed under Ordering Information. Contact Linx for availability of PCB layout design files.

The recommended layout includes a matching network, ground plane and PCB transmission line from the antenna to the matching network, and to the connector or radio circuitry. The connector used for the evaluation board is optional, the transmission line may be run directly to the radio if on the same PCB.

MATCHING NETWORK

Linx recommends inclusion of at least a 3-element, surface mount pi matching network of two parallel capacitors, (X1, X3) and one serial inductor, (X2) in all designs. (Figure 9) Surface mount components should be 0603 size. 0402 size components are also supported. The ANT-DB1-nSP250, as designed, does not require matching, but matching may improve end-product antenna performance depending on the effects of the enclosure, PCB and other electronic components. If no matching is necessary, the serial element may be populated with a zero-ohm resistor and no components in the two capacitor positions. This is the configuration of the Linx evaluation board as supplied. Linx believes in wireless made simple® and offers matching network design support.

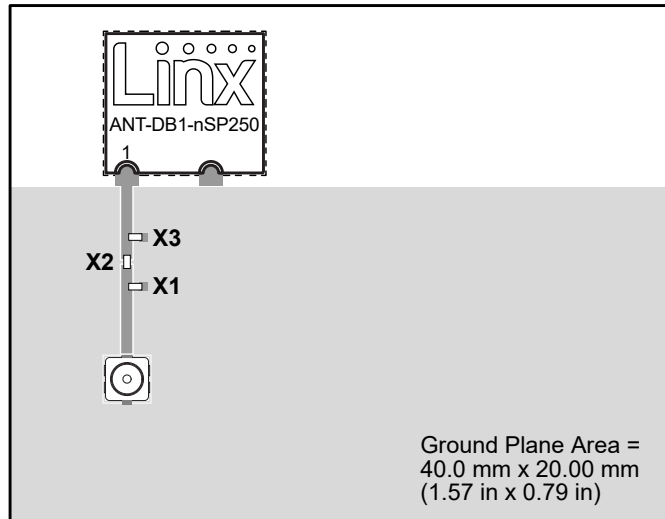

Figure 8. Linx nSP250 Recommended Layout

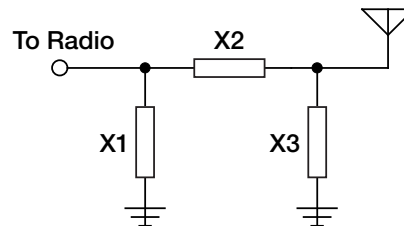

Figure 9. Matching Network Recommendation

RECOMMENDED PCB FOOTPRINT

Figure 10 shows the recommended printed circuit board footprint and spacing for the ANT-DB1-nSP250 antenna. The footprint recommendation should be used in conjunction with the recommended layout configuration shown in Figure 8.

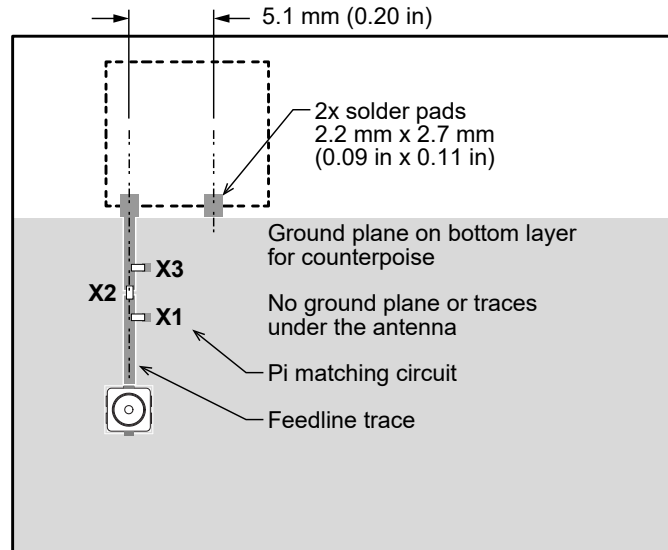

Figure 10. nanoSplatrch Placement on PCB

TRANSMISSION LINES FOR EMBEDDED ANTENNAS

For most designs, Linx recommends a microstrip transmission line for the ANT-DB1-nSP250. A microstrip transmission line is a PCB trace that runs over a ground plane to maintain the characteristic impedance for optimal signal transfer between the antenna and radio circuitry. Linx designs all antennas with a characteristic impedance of 50 Ω .

Important practices to observe when designing a transmission line are:

- Keep all transmission lines to a minimum length for best signal performance
- Use RF components that also operate at a 50 Ω impedance
- If the radio is not on the same PCB as the antenna the microstrip should be terminated in a connector enabling a shielded cable to complete the antenna connection to the radio, as exemplified on the nSP250 evaluation board
- For designs subject to significant electromagnetic interference, a coplanar waveguide transmission line may be used on the PCB

The design of a PCB transmission line can be aided by many commercially available software packages which can calculate the correct transmission line width and gap dimensions based upon the PCB thickness and dielectric constant used.

REFLOW SOLDER PROFILE

The nSP250 uses a typical RoHS solder reflow profile. Refer to application note AN-00504 on the Linx website for more information.

TAPE AND REEL PACKAGING

Figure 11 shows the dimensions of the tape in which the nSP250 is packaged. Reel dimensions are provided in Figure 12.

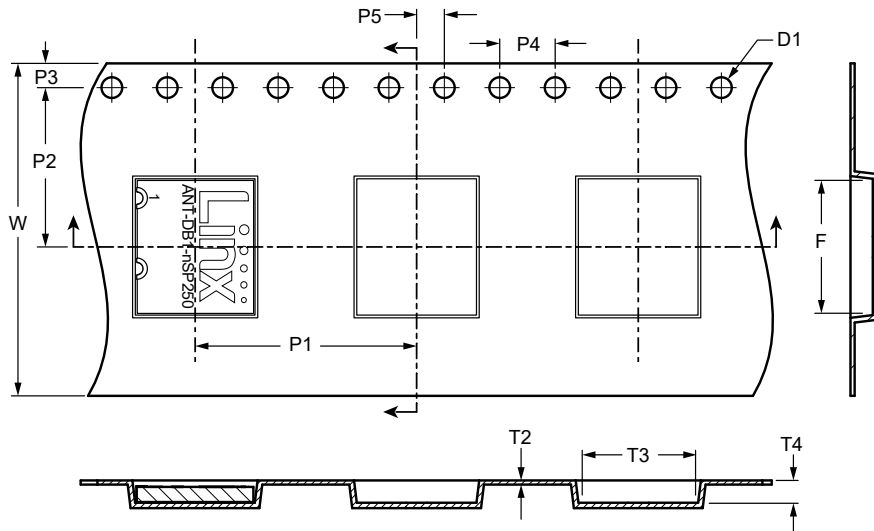

Tape Dimensions		
Symbol	Dimension (mm)	Tolerance
D1	1.50	± 0.10
D2	1.50	± 0.10
F	9.9	± 0.10
P1	16.00	± 0.10
P2	11.50	± 0.10
P3	1.75	± 0.10
P4	4.00	± 0.10
P5	2.00	± 0.10
T2	0.30	± 0.05
T3	8.70	± 0.10
T4	1.40	± 0.10
W	24.00	± 0.30

Figure 11. Tape Specifications for the nanoSplatch Antenna

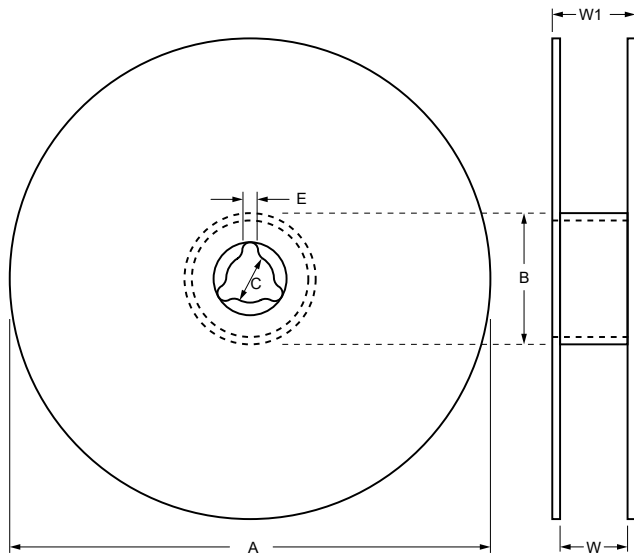

Reel Dimensions		
Symbol	nSP250	Unit
QTY per reel	1,000	pcs
Tape width	24	mm
A	330 ±1	mm
B	100 ±0.5	mm
C	13 ±0.5	mm
E	2.2 ±0.5	mm
W	24 ±0.5	mm
W1	28.9 ±0.2	mm

Figure 12. Reel Specifications for the nanoSplatch Antenna

ANTENNA DEFINITIONS AND USEFUL FORMULAS

VSWR - Voltage Standing Wave Ratio. VSWR is a unitless ratio that describes the power reflected from the antenna back to the radio. A lower VSWR value indicates better antenna performance at a given frequency. VSWR is easily derived from Return Loss.

$$\text{VSWR} = \frac{10^{\left[\frac{\text{Return Loss}}{20}\right]} + 1}{10^{\left[\frac{\text{Return Loss}}{20}\right]} - 1}$$

Return Loss - Return loss represents the loss in power at the antenna due to reflected signals, measured in decibels. A lower return loss value indicates better antenna performance at a given frequency. Return Loss is easily derived from VSWR.

$$\text{Return Loss} = -20 \log_{10} \left[\frac{\text{VSWR} - 1}{\text{VSWR} + 1} \right]$$

Efficiency (η) - The total power radiated from an antenna divided by the input power at the feed point of the antenna as a percentage.

Total Radiated Efficiency - (TRE) The total efficiency of an antenna solution comprising the radiation efficiency of the antenna and the transmitted (forward) efficiency from the transmitter.

$$\text{TRE} = \eta \cdot \left(1 - \left(\frac{\text{VSWR} - 1}{\text{VSWR} + 1} \right)^2 \right)$$

Gain - The ratio of an antenna's efficiency in a given direction (G) to the power produced by a theoretical lossless (100% efficient) isotropic antenna. The gain of an antenna is almost always expressed in decibels.

$$G_{\text{db}} = 10 \log_{10}(G)$$

$$G_{\text{dBd}} = G_{\text{dBi}} - 2.51\text{dB}$$

Peak Gain - The highest antenna gain across all directions for a given frequency range. A directional antenna will have a very high peak gain compared to average gain.

Average Gain - The average gain across all directions for a given frequency range.

Maximum Power - The maximum signal power which may be applied to an antenna feed point, typically measured in watts (W).

Reflected Power - A portion of the forward power reflected back toward the amplifier due to a mismatch at the antenna port.

$$\left(\frac{\text{VSWR} - 1}{\text{VSWR} + 1} \right)^2$$

decibel (dB) - A logarithmic unit of measure of the power of an electrical signal.

decibel isotropic (dBi) - A comparative measure in decibels between an antenna under test and an isotropic radiator.

decibel relative to a dipole (dBd) - A comparative measure in decibels between an antenna under test and an ideal half-wave dipole.

Dipole - An ideal dipole comprises a straight electrical conductor measuring 1/2 wavelength from end to end connected at the center to a feed point for the radio.

Isotropic Radiator - A theoretical antenna which radiates energy equally in all directions as a perfect sphere.

Omnidirectional - Term describing an antenna radiation pattern that is uniform in all directions. An isotropic antenna is the theoretical perfect omnidirectional antenna. An ideal dipole antenna has a donut-shaped radiation pattern and other practical antenna implementations will have less perfect but generally omnidirectional radiation patterns which are typically plotted on three axes.

TE TECHNICAL SUPPORT CENTER

USA:	+1 (800) 522-6752
Canada:	+1 (905) 475-6222
Mexico:	+52 (0) 55-1106-0800
Latin/S. America:	+54 (0) 11-4733-2200
Germany:	+49 (0) 6251-133-1999
UK:	+44 (0) 800-267666
France:	+33 (0) 1-3420-8686
Netherlands:	+31 (0) 73-6246-999
China:	+86 (0) 400-820-6015

te.com

TE Connectivity, TE, TE connectivity (logo), Linx and Linx Technologies are trademarks owned or licensed by the TE Connectivity Ltd. family of companies. All other logos, products and/or company names referred to herein might be trademarks of their respective owners.

The information given herein, including drawings, illustrations and schematics which are intended for illustration purposes only, is believed to be reliable. However, TE Connectivity makes no warranties as to its accuracy or completeness and disclaims any liability in connection with its use. TE Connectivity's obligations shall only be as set forth in TE Connectivity's Standard Terms and Conditions of Sale for this product and in no case will TE Connectivity be liable for any incidental, indirect or consequential damages arising out of the sale, resale, use or misuse of the product. Users of TE Connectivity products should make their own evaluation to determine the suitability of each such product for the specific application.

TE Connectivity warrants to the original end user customer of its products that its products are free from defects in material and workmanship. Subject to conditions and limitations TE Connectivity will, at its option, either repair or replace any part of its products that prove defective because of improper workmanship or materials. This limited warranty is in force for the useful lifetime of the original end product into which the TE Connectivity product is installed. Useful lifetime of the original end product may vary but is not warranted to exceed one (1) year from the original date of the end product purchase.

©2022 TE Connectivity. All Rights Reserved.

09/22 Original