



## VersAnte L000321-01

### Ground Plane Independent 3-Port IoT Puck Antenna - 4G/5G Cellular / Wi-Fi / GNSS

The VersAnte L000321-01 antenna offers 4G/5G cellular, Wi-Fi and GNSS coverage in an extremely compact form factor.

As a ground plane independent antenna, this antenna can operate on both metallic and non-metallic surfaces.

This feature combined with an IP67 rating makes this antenna an ideal solution for a broad range of IoT applications in both indoor and outdoor environments.

### FEATURES AND BENEFITS

- 4G/5G Cellular, Wi-Fi and GNSS from a single antenna
- Supports CAT-M, CAT-1 to CAT-4, and NB-IoT
- Suitable for mounting on a variety of surfaces
- Radome is paintable using commonly available spray paints (must not contain metal)
- Versatile for a number of applications
- Ground plane independent
- Low profile, extremely compact form factor
- Ruggedized and less prone to vandalism

### APPLICATIONS

- IoT endpoints
- Digital display and signage
- EV charging
- Smart lockers and storage
- Ticketing systems
- Smart terminals
- Data monitoring

### ELECTRICAL SPECIFICATION

	4G/5G Cellular					Wi-Fi	
Operating Frequency (MHz)	698-750	750-850	850-960	1690-2690	3300-3800	2400-2500	5150-5900
Free Space Performance							
VSWR - Typical	<3.9:1	<3.5:1	<4.0:1	<1.5:1	<1.5:1	<1.5:1	<1.5:1
Peak Gain - Max (dBi)	1.83			6		3	4
On Metallic Ground Plane Performance							
VSWR - Typical	<3.0:1	<3.3:1	<4.0:1	<1.5:1	<1.5:1	<1.5:1	<1.5:1
Peak Gain - Max (dBi)	2.86			6		6	5.5
Isolation (dB)	>-15			>-10	>-20	>-10	>-25
Input Max Power (W)	20					5	
Polarization	Linear						
Azimuth Beamwidth	360 °, Omnidirectional						

Measured with a 3.3 ft (1 m) cable, with and without a 2 ft (0.6m) diameter ground plane

## ELECTRICAL SPECIFICATION - GNSS

Frequency (MHz)	1559-1606
Passive Antenna Gain (dBi)	3.0
LNA Gain @ Room Temperature (dB)	26 ± 3
Noise Figure @ Room Temperature (dB)	< 2.8
Max VSWR @ Room Temperature	< 2.0:1
Polarization	RHCP
Nominal Impedance (ohm)	50
Operating Supply Voltage (Vdc)	2.5-7.0
Current Consumption, Max @ room temp. (mA)	11.5 @ 3.0V
Out-of-band Signal Rejection, Min @ room temp. (dBc)	80 @ 1 – 1525 MHz 80 @ 1428 – 2700 MHz 70 @ 4900 – 5800 MHz

## MECHANICAL SPECIFICATION

Dimensions - height x diameter - mm (in.)	26 x Ø90.2 (1.02 x 3.55)
Weight - g (oz.)	175.5 (6.19)
Mounting	M16 Stud
Radome	ASA (Black)
Cable	RG174 (3.3 feet / 1m)
Connector	4G/5G Cellular - SMA, Wi-Fi - RP-SMA, GNSS - SMA

## ENVIRONMENTAL SPECIFICATION

Operating Temperature - °C (°F)	-40 to +85°C (-40 to +185°F)
Storage Temperature - °C (°F)	-40 to +85°C (-40 to +185°F)
Ingress Protection (IP Rating)	IP67
Material Substance Compliance	RoHS Compliant CE & UKCA Compliant

## GLOBAL 4G/5G CELLULAR COVERAGE

FREQUENCY	RF BANDS
698-806 MHz	12, 13, 14, 17, 28, 29, 44, 67, 68, 85 N12, N14, N28, N29, N83
807-960 MHz	5, 6, 8, 18, 19, 20, 26, 27 N5, N8, N18, N20, N81, N82, N89, N91, N92, N93, N94
1690-2200 MHz	1, 2, 3, 4, 9, 10, 15, 16, 23, 25, 33, 34, 35, 36, 37, 39, 65, 66, 70 N34, N39, N65, N66, N70, N80, N84, N86, N95
2200-2700 MHz	7, 30, 38, 40, 41, 69 N30, N38, N40, N41, N90
3300-3800 MHz	22, 42, 43, 48 N48, N78

# MECHANICAL DRAWINGS

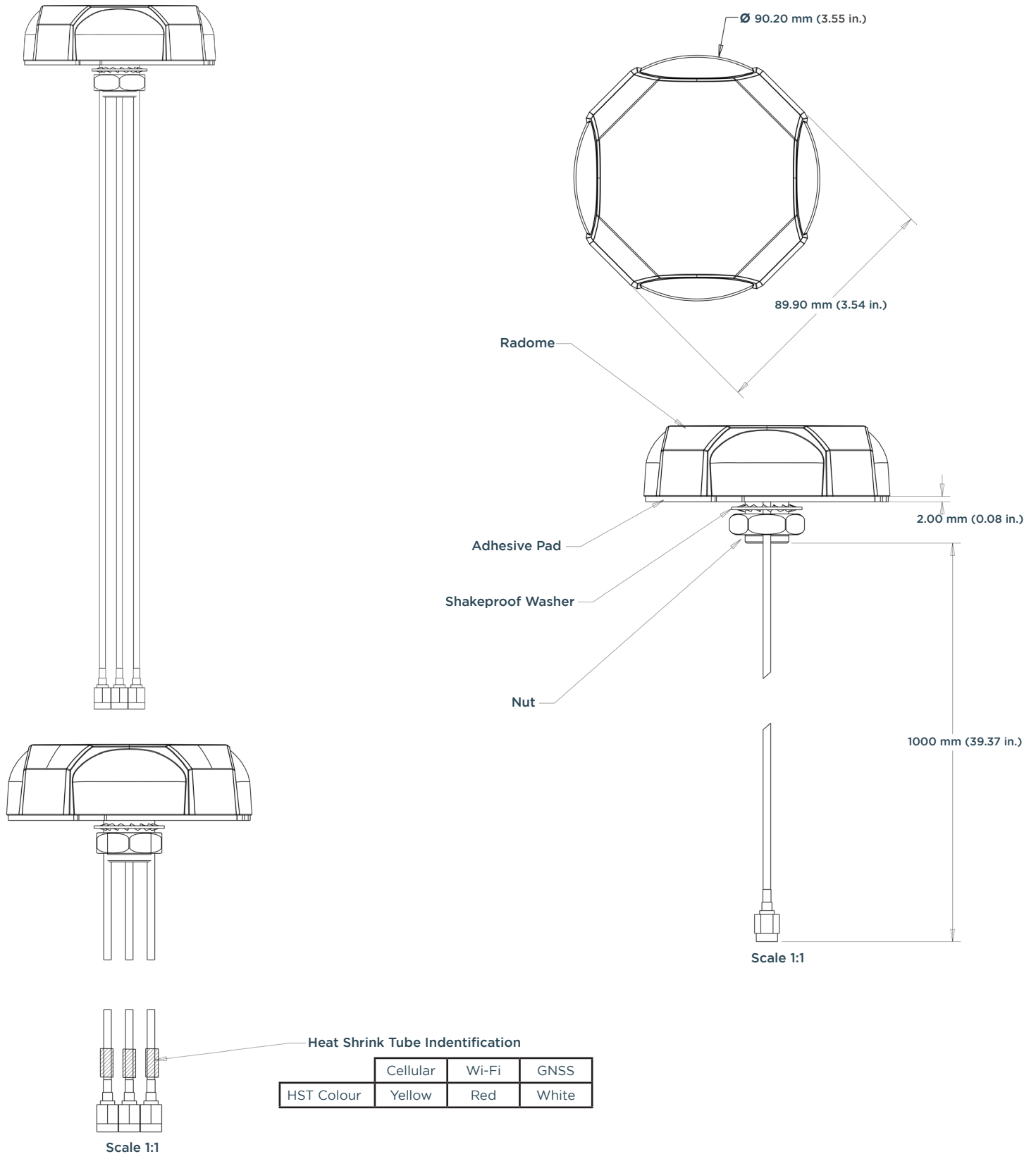

# RADIATION PATTERNS - 4G/5G CELLULAR

**Key**

Measured in Free Space      Measured with Ground Plane

**Note** - A label on the antenna base indicates the direction of 0° for ease of orientation and placement.

## Radiation Patterns at 698 MHz

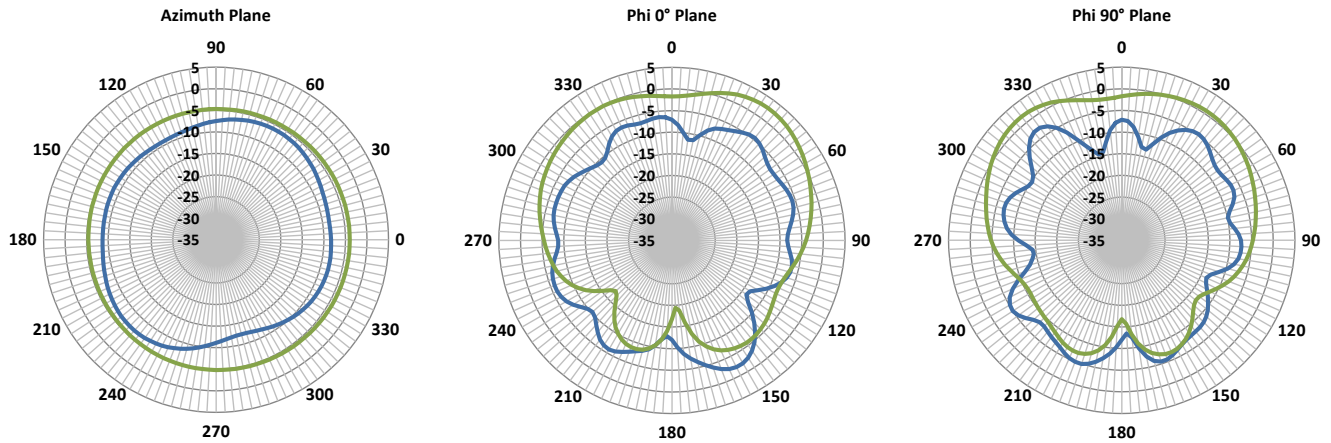

## Radiation Patterns at 750 MHz

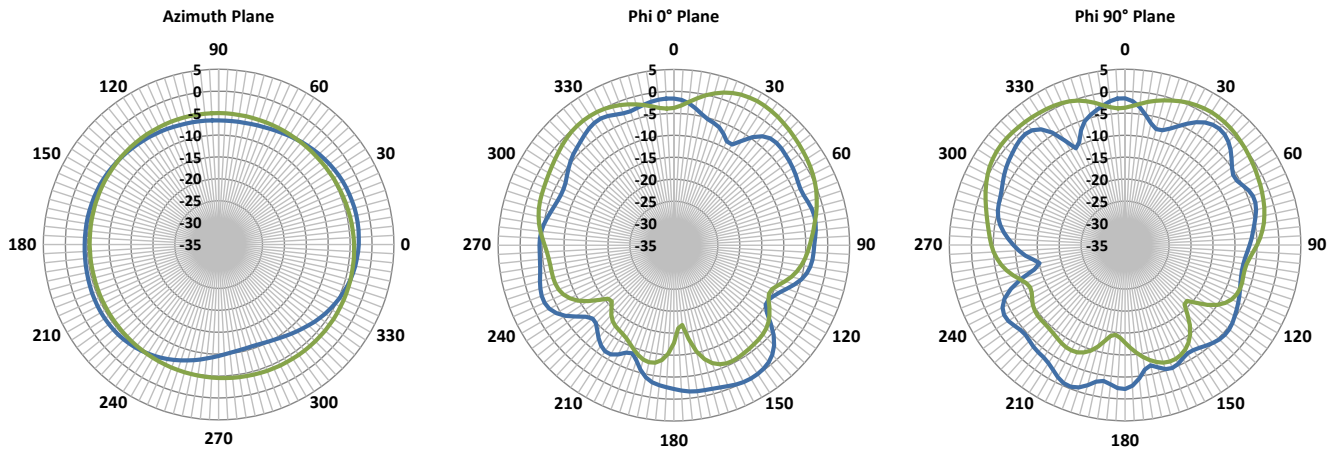

## Radiation Pattern at 850 MHz

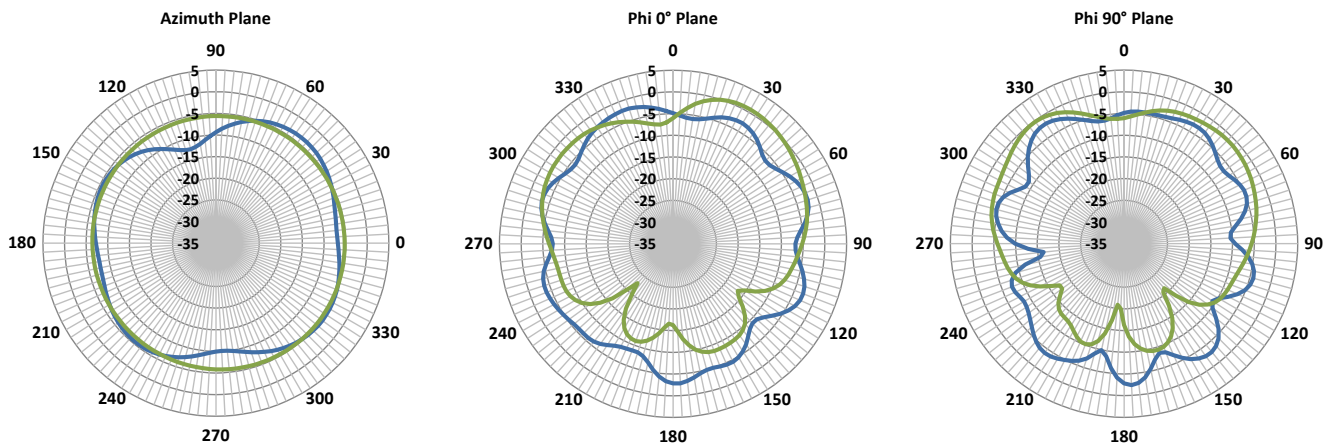

## Radiation Pattern at 960 MHz

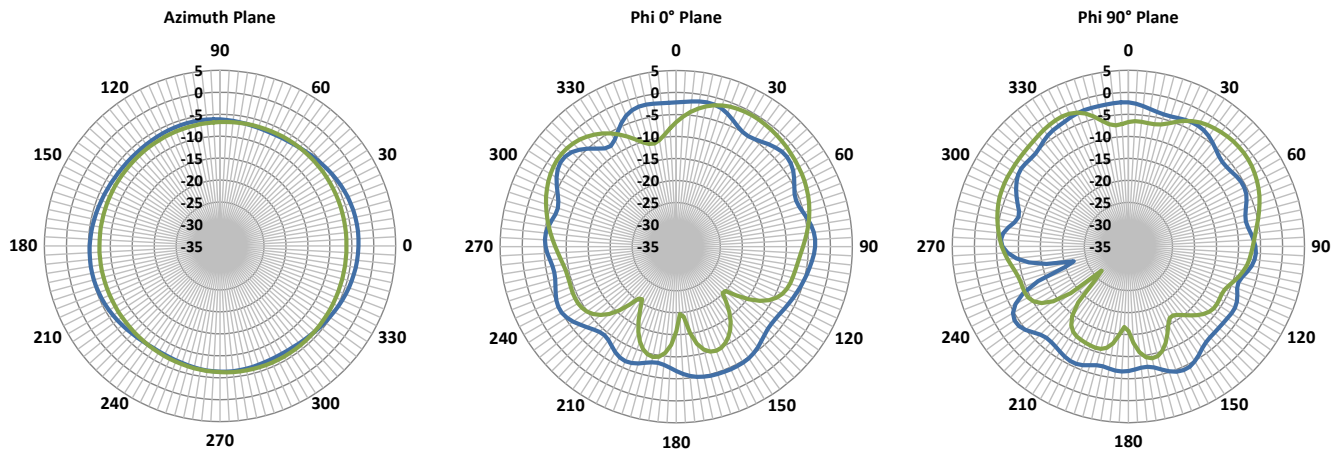

## Radiation Pattern at 1690 MHz

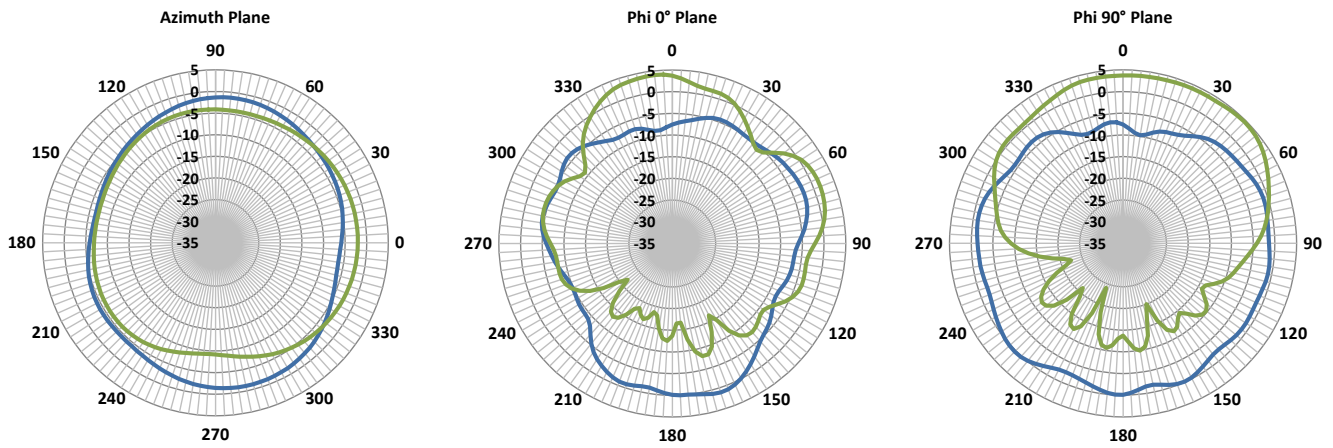

## Radiation Pattern at 1800 MHz

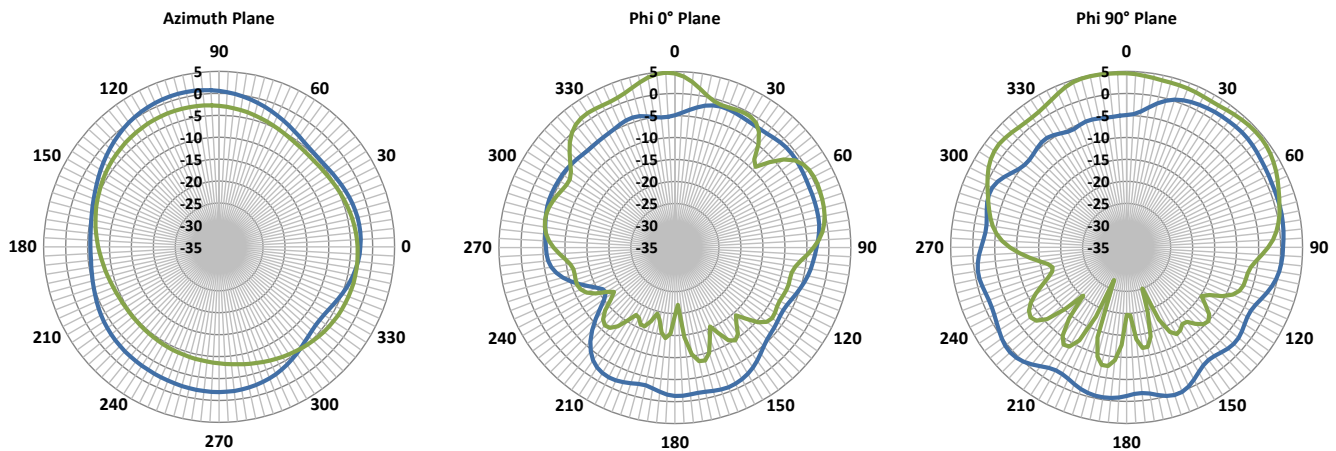

## Radiation Pattern at 1900 MHz

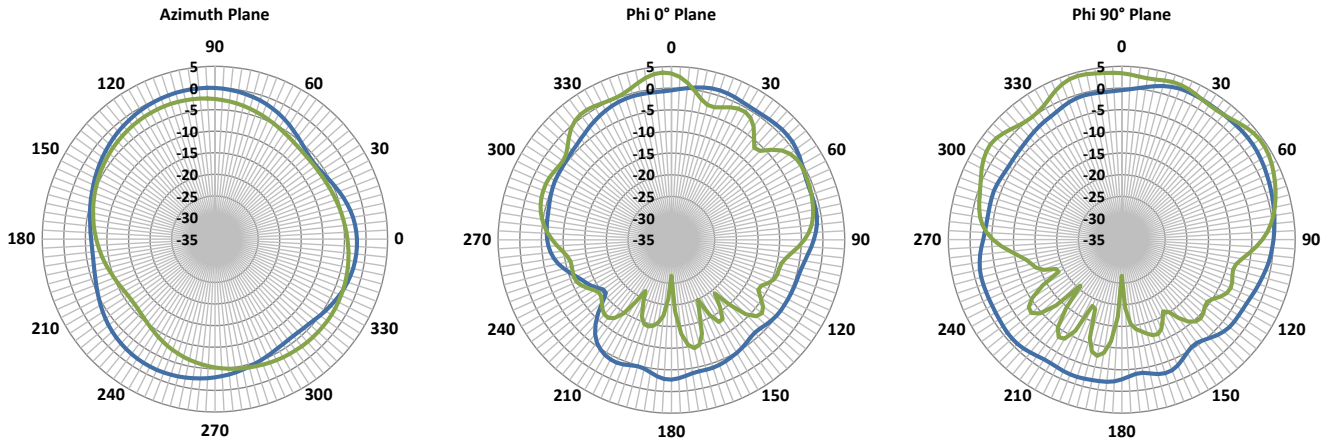

## Radiation Pattern at 2100 MHz

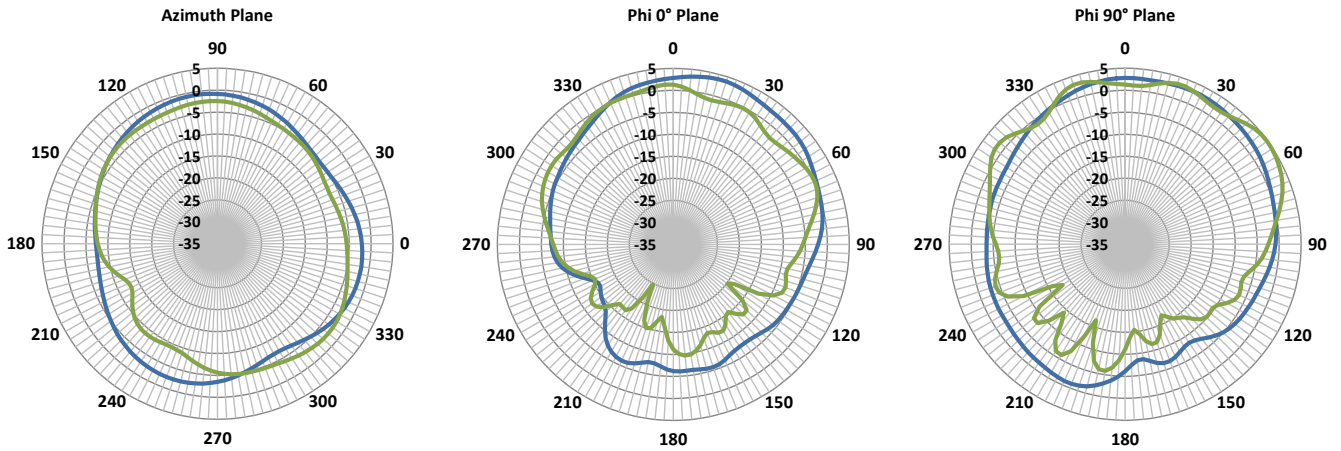

## Radiation Pattern at 2200 MHz

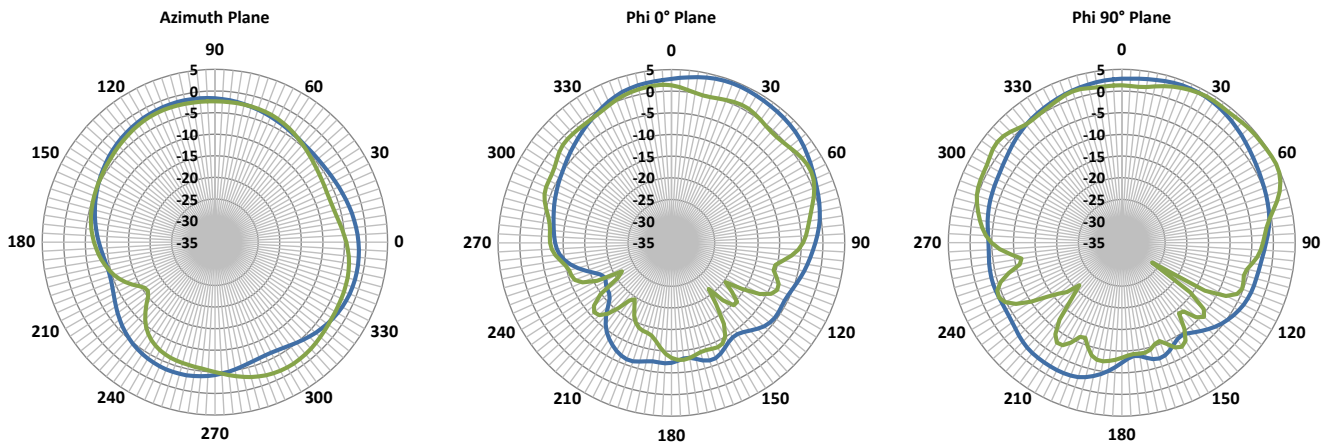

## Radiation Pattern at 2300 MHz

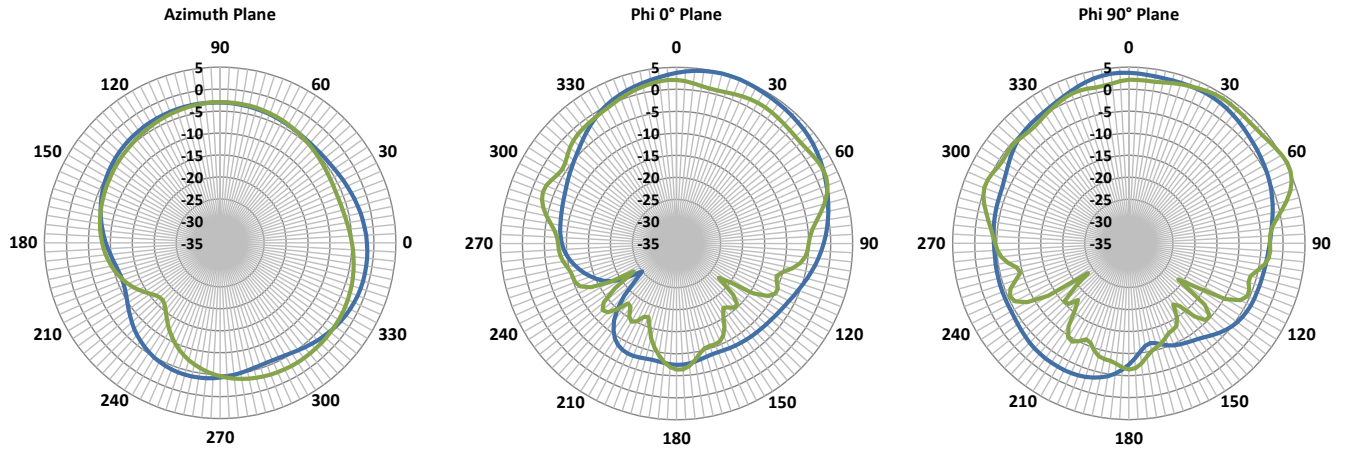

## Radiation Pattern at 2500 MHz

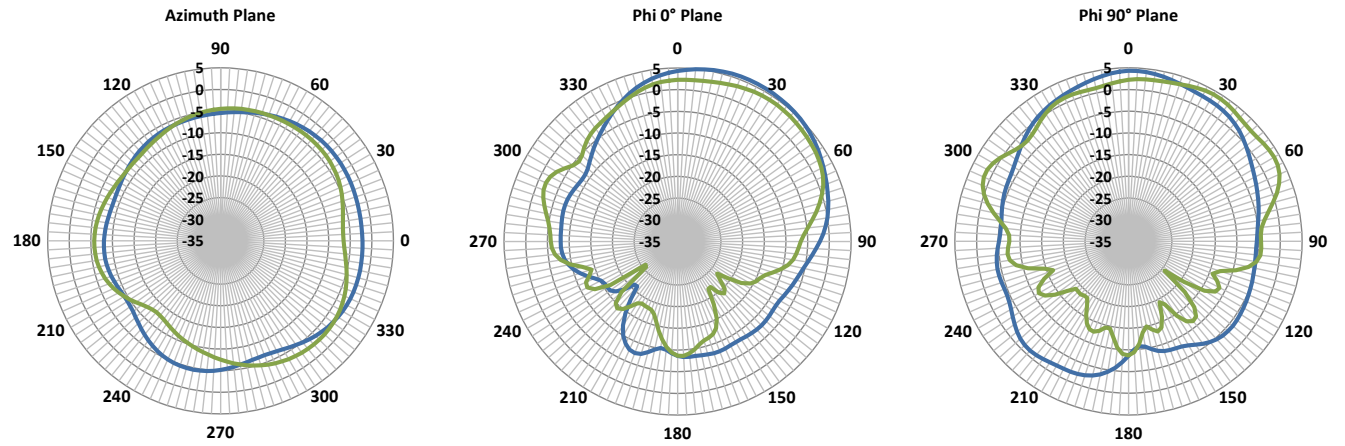

## Radiation Pattern at 2600 MHz

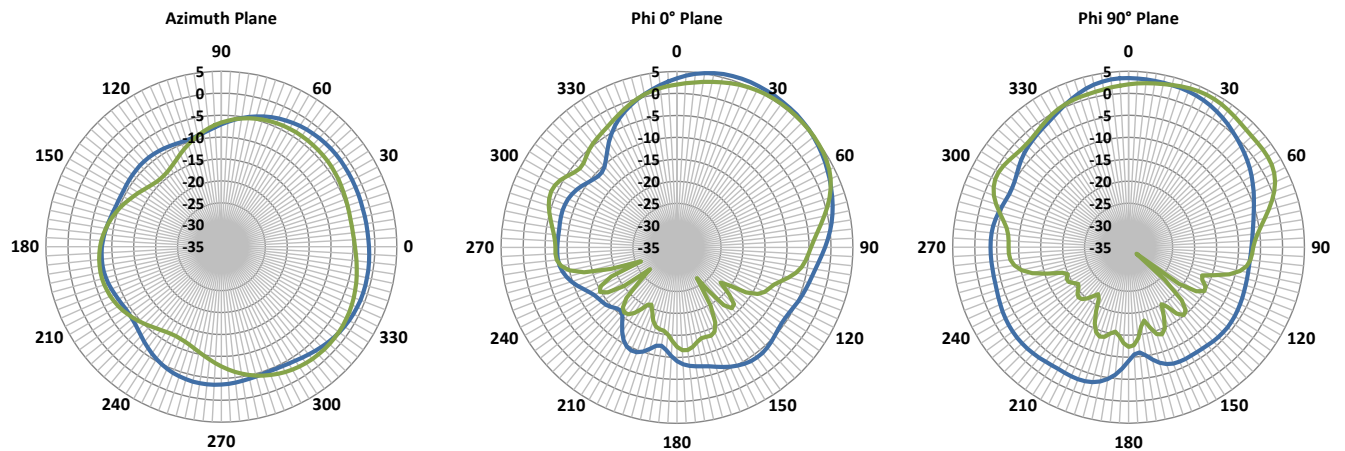

## Radiation Pattern at 2690 MHz

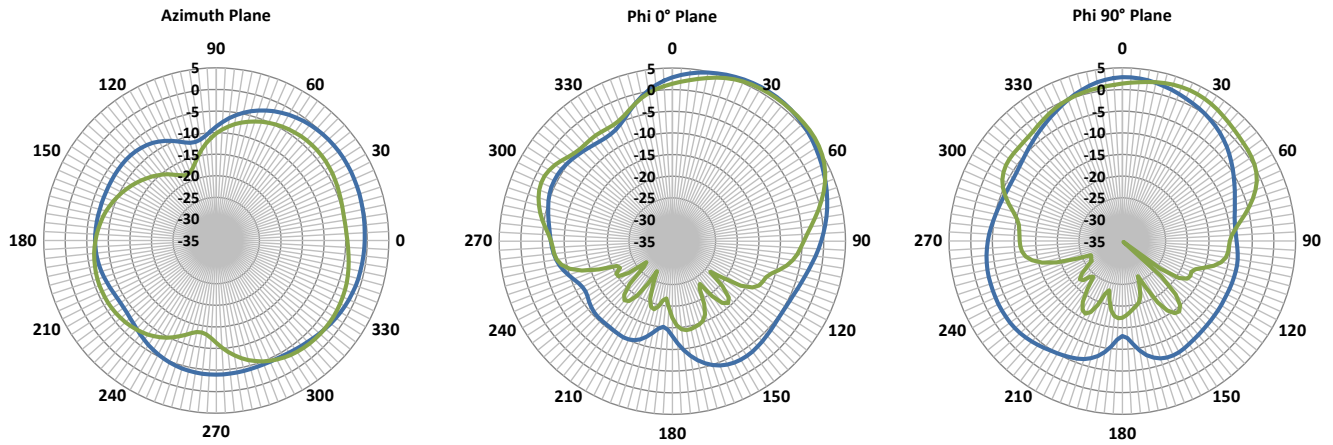

## Radiation Pattern at 3300 MHz

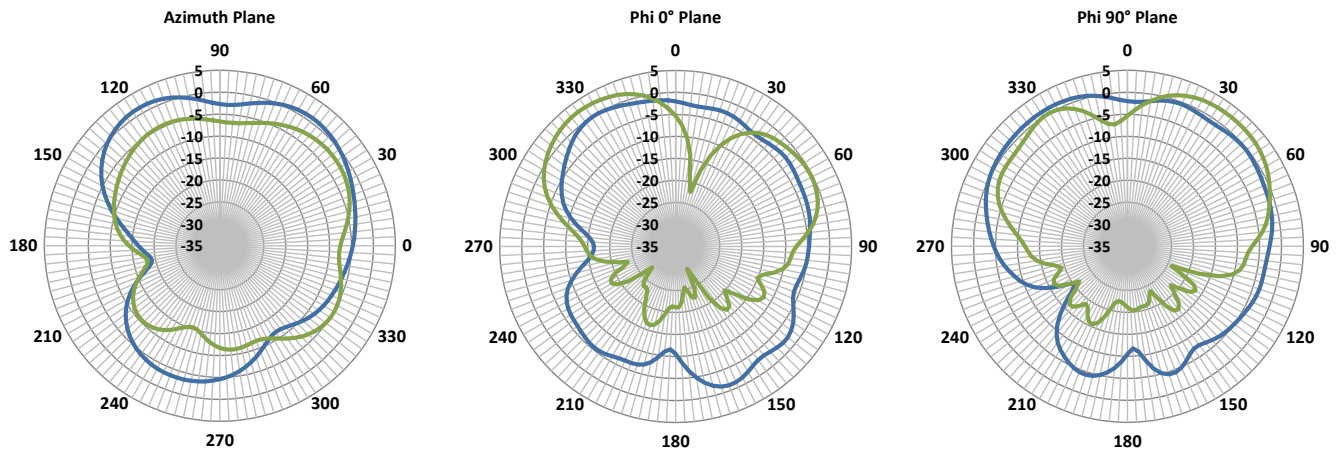

## Radiation Pattern at 3500 MHz

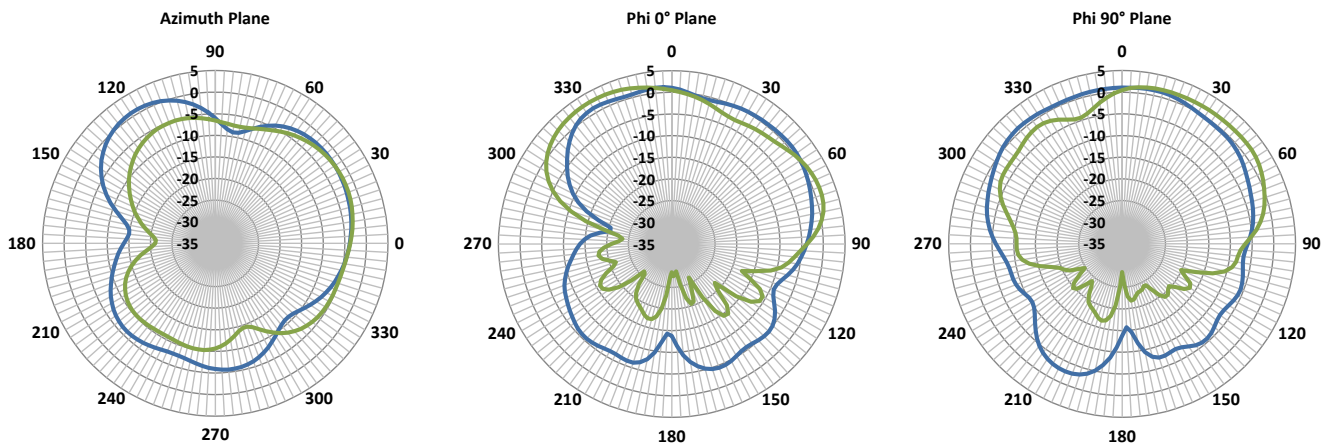



## Radiation Pattern at 3800 MHz

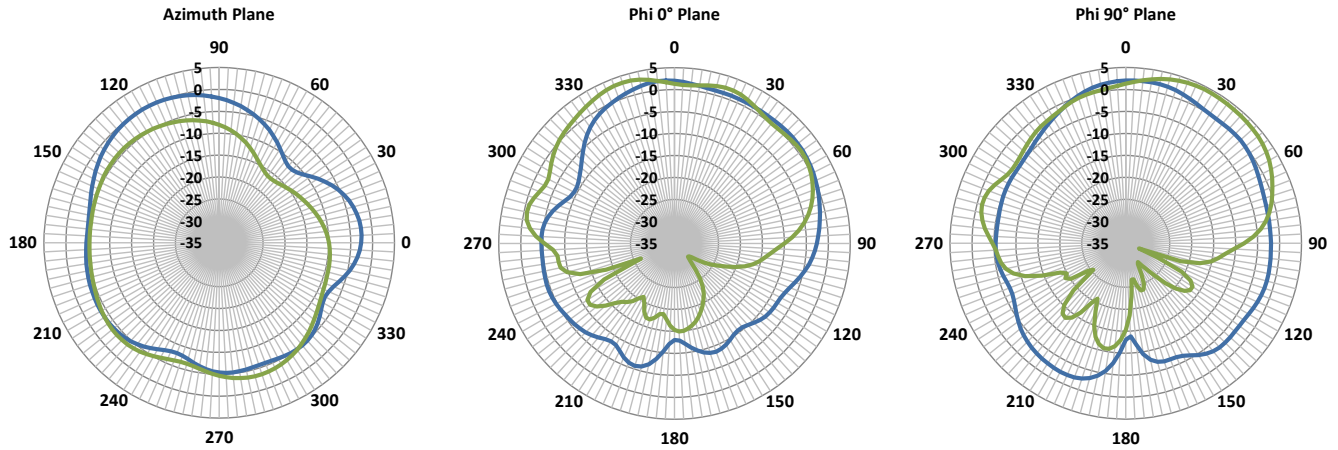

## RADIATION PATTERNS - WI-FI

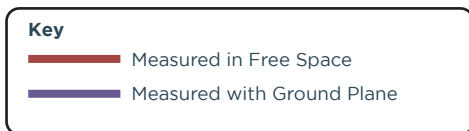

## Radiation Pattern at 2400 MHz

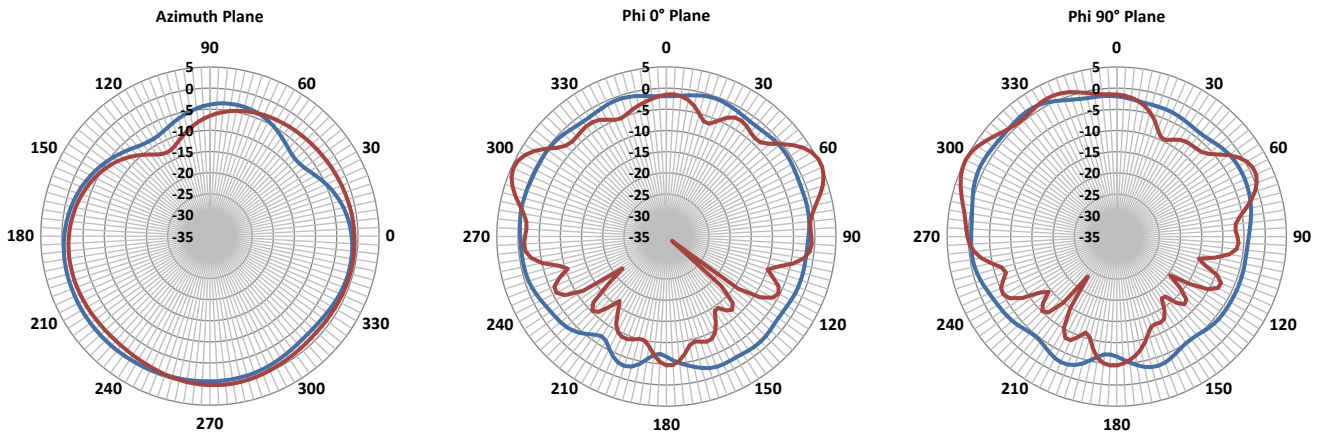

## Radiation Pattern at 2480 MHz

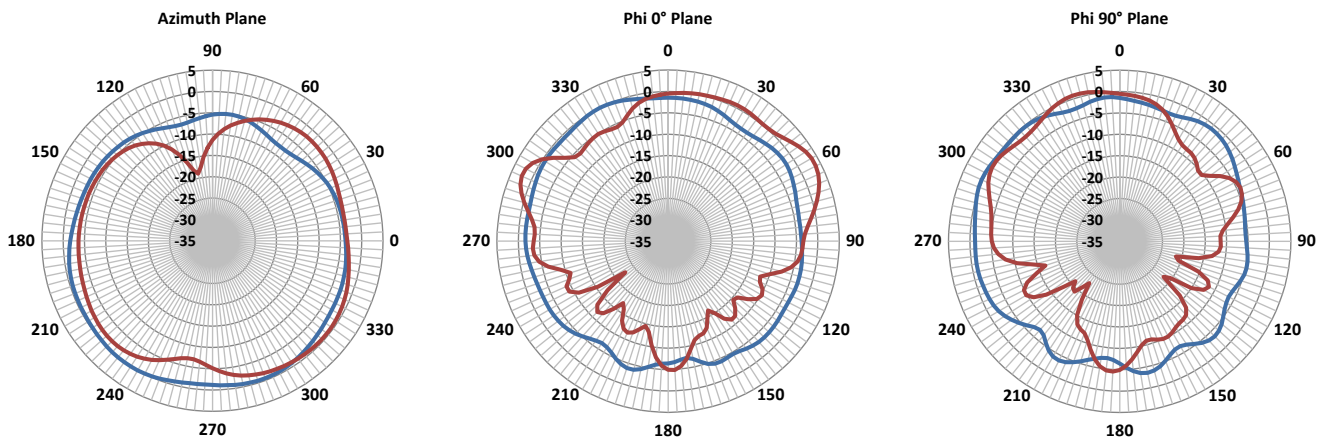

## Radiation Pattern at 5150 MHz

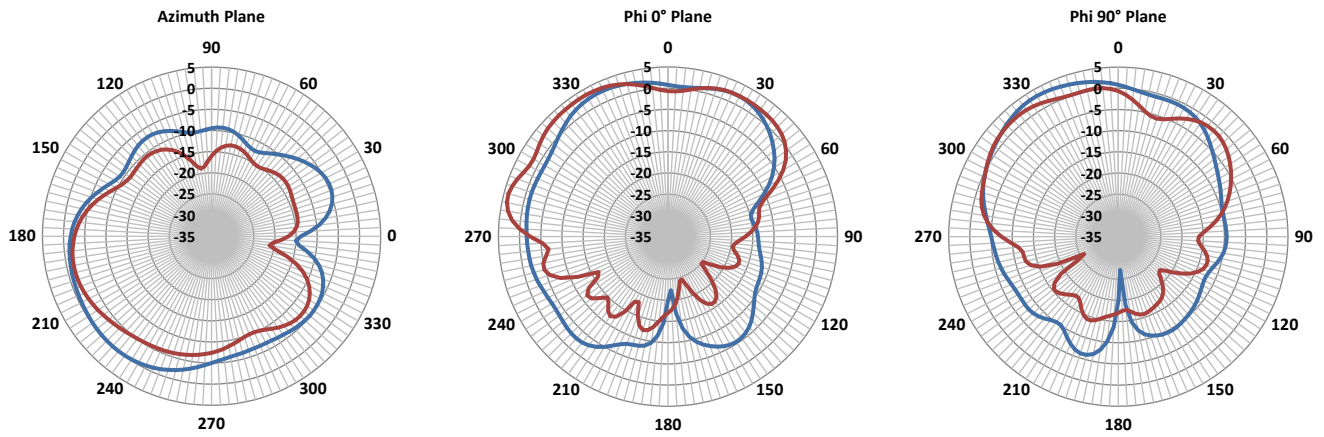

## Radiation Pattern at 5450 MHz

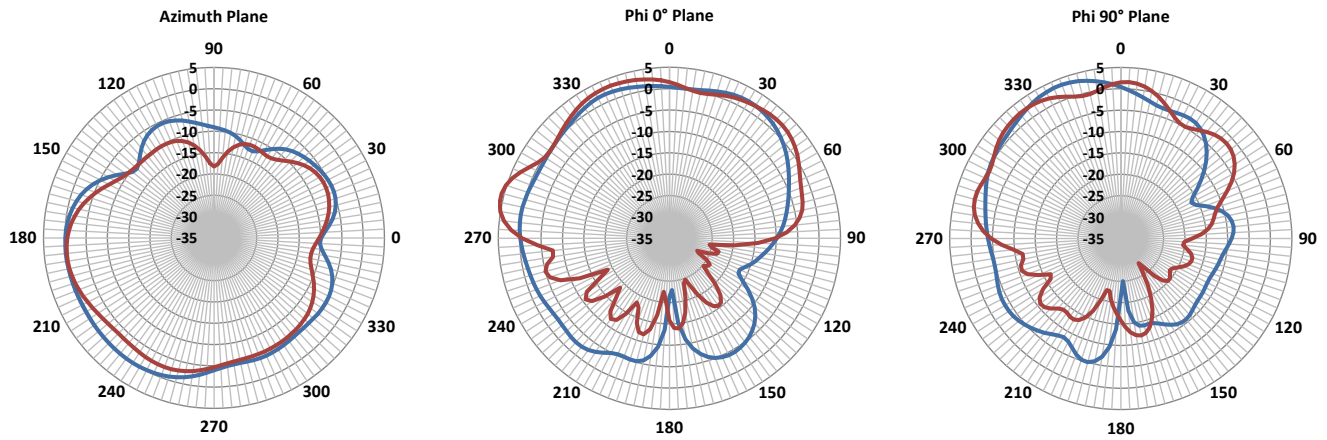

## Radiation Pattern at 5850 MHz

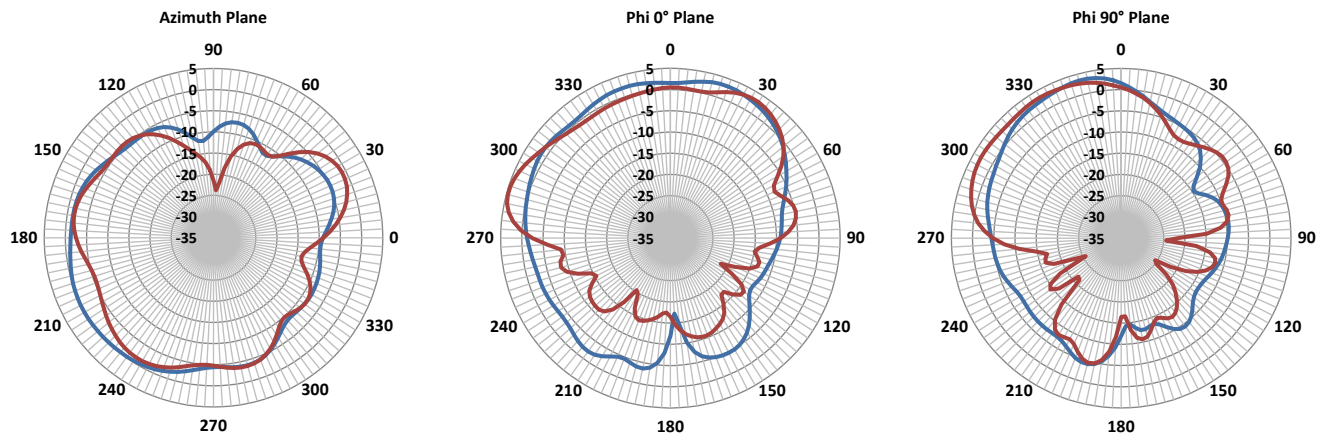

## PACKING INFORMATION

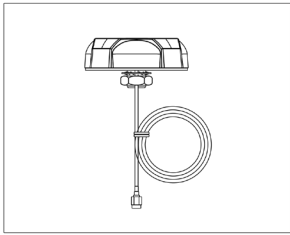

1 PCS/Bubble Pack

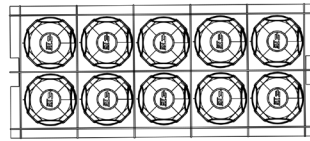

5 PCS x 2  
Grid - 10PCS/layer

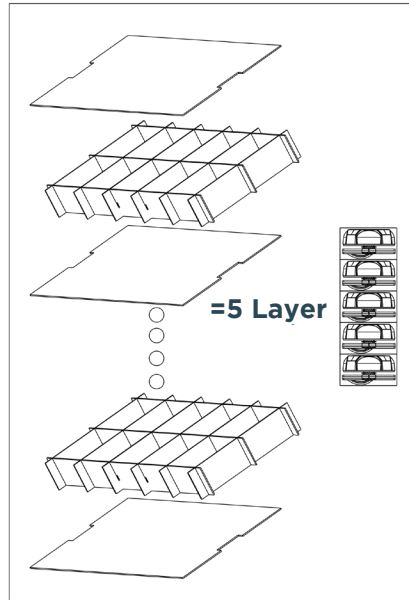

=5 Layer

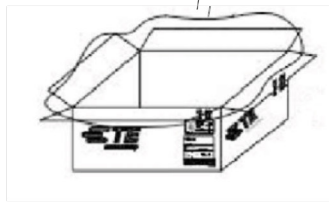

Waterproof Bag

10 PCS/layer x 5  
=50 PCS/Carton

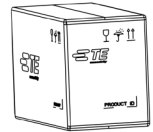
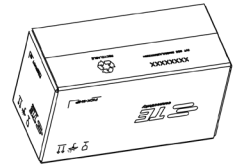

Carton = 50 PCS

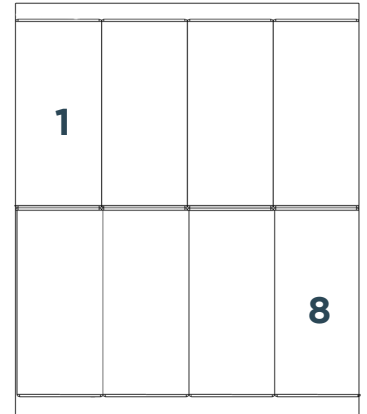

Pallet - 1200x1000mm  
Carton x 8 PCS - 4 Layers  
Total - 1600 PCS Antenna

## TE TECHNICAL SUPPORT CENTER

USA:	+1 (800) 522-6752
Canada:	+1 (905) 475-6222
Mexico:	+52 (0) 55-1106-0800
Latin/S. America:	+54 (0) 11-4733-2200
Germany:	+49 (0) 6251-133-1999
UK:	+44 (0) 800-267666
France:	+33 (0) 1-3420-8686
Netherlands:	+31 (0) 73-6246-999
China:	+86 (0) 400-820-6015

## te.com

TE, and TE connectivity (logo) are trademarks owned or licensed by the TE Connectivity Ltd. family of companies. All other logos, products and/or company names referred to herein might be trademarks of their respective owners.

The information given herein, including drawings, illustrations and schematics which are intended for illustration purposes only, is believed to be reliable. However, TE Connectivity makes no warranties as to its accuracy or completeness and disclaims any liability in connection with its use. TE Connectivity's obligations shall only be as set forth in TE Connectivity's Standard Terms and Conditions of Sale for this product and in no case will TE Connectivity be liable for any incidental, indirect or consequential damages arising out of the sale, resale, use or misuse of the product. Users of TE Connectivity products should make their own evaluation to determine the suitability of each such product for the specific application.

TE Connectivity warrants to the original end user customer of its products that its products are free from defects in material and workmanship. Subject to conditions and limitations TE Connectivity will, at its option, either repair or replace any part of its products that prove defective because of improper workmanship or materials. This limited warranty is in force for the useful lifetime of the original end product into which the TE Connectivity product is installed. Useful lifetime of the original end product may vary but is not to exceed one (1) year from the original date of the end product purchase.

©2023 TE Connectivity. All Rights Reserved.

03/23 Original