

XENSIV™ digital absolute pressure sensor

Features

- High accuracy pressure sensing (± 1.0 kPa), pressure range 40 to 115 kPa
- Operating ambient temperature range -40°C to 125°C
- Best in class low power consumption with dedicated power-down mode for energy saving
- 10-, 12- or 14-bit resolution pressure and temperature values via SPI Interface
- Integrated signal path diagnosis features
- Green, small 4.5 mm x 5.1 mm 8-pin DFN package



Potential applications

- Automotive barometric air pressure sensor (BAP)
- Automotive manifold air flow sensor (MAF)
- Automotive battery monitoring system (BMS)
- Automotive seat comfort system
- Industrial control
- Weather stations
- Altimeters

Product validation

Product validation according to AEC-Q103-002. Qualified for automotive applications.

Description

The KP464 is a high-performance, high-precision miniaturized digital absolute pressure sensor based on a capacitive sensing principle. It is surface micromachined with a monolithic integrated signal conditioning circuit.

The device converts a physical pressure into a 10-, 12- or 14-bit digital value and transmits the information via the SPI interface. In addition, a temperature sensor is integrated on chip. Based on the received SPI command, the 10-, 12- or 14-bit temperature information will also be transmitted via the SPI interface.

The device has implemented a particular Power-Down Mode which allows the user to even reduce the power consumption of the device. A special reliability feature are the integrated diagnostics, which allows testing the sensor cells as well as the signal path. This diagnosis can be triggered with a SPI command.

Product type	Package	Marking	Ordering code
KP464	PG-DFN-8-1	KP464	SP005430033

Table of contents

	Table of contents	2
1	Block diagram	4
2	Pin configuration	5
3	General product characteristics	6
3.1	Absolute maximum ratings	6
3.2	Functional range	7
4	Product features	8
4.1	Characteristics	8
4.1.1	Electrical characteristics	8
4.1.2	Transfer function pressure characteristics	9
4.1.3	Transfer function temperature characteristics	10
4.1.4	Undervoltage range characteristics	10
4.1.5	SPI timing	10
4.2	Functional description	12
4.2.1	Transfer function pressure	12
4.2.2	Transfer function temperature	14
4.2.3	Power-down mode	17
4.2.3.1	Entering power-down mode	17
4.2.3.2	Exiting power-down mode	17
4.2.4	Serial interface	17
4.2.4.1	EEPROM programmability	18
4.2.4.2	Commands	18
4.2.4.3	Command behaviour	18
4.2.4.4	Structure	18
4.2.4.5	Parity	20
4.2.4.6	Command definition	20
4.2.4.7	Communication error	23
4.2.4.8	Identifier response definition	23
4.2.4.9	Single device operation	23
4.2.4.10	Daisy chain operation	24
4.2.4.11	SPI configuration parameters	25
4.2.5	Diagnosis	27
4.2.5.1	Diagnosis reset	28
4.2.5.1.1	Reset-bit = '1'	28
4.2.5.1.2	Reset-bit = '0'	29
4.2.5.2	Pressure out of range	29
4.2.5.3	Diag1	29
4.2.5.4	Diag2	29

4.2.5.5	EEPROM check	30
4.2.6	Calculation of overall power consumption	30
4.2.7	Start-up behavior	30
5	Application information	31
6	Package	32
6.1	Identification code	33
7	Revision history	35
	Disclaimer	36

1 Block diagram

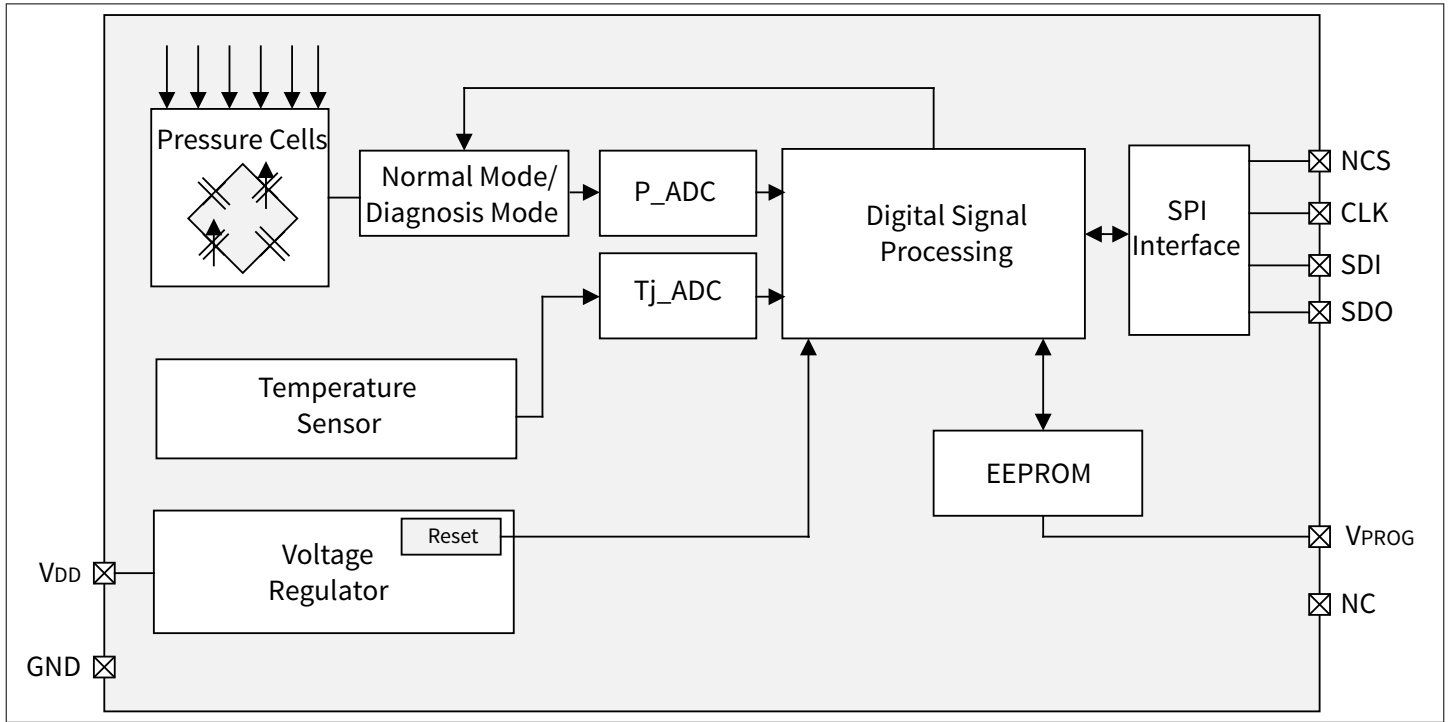

Figure 1 Functional block diagram

2 Pin configuration

The figure below defines the pin configuration of the device.

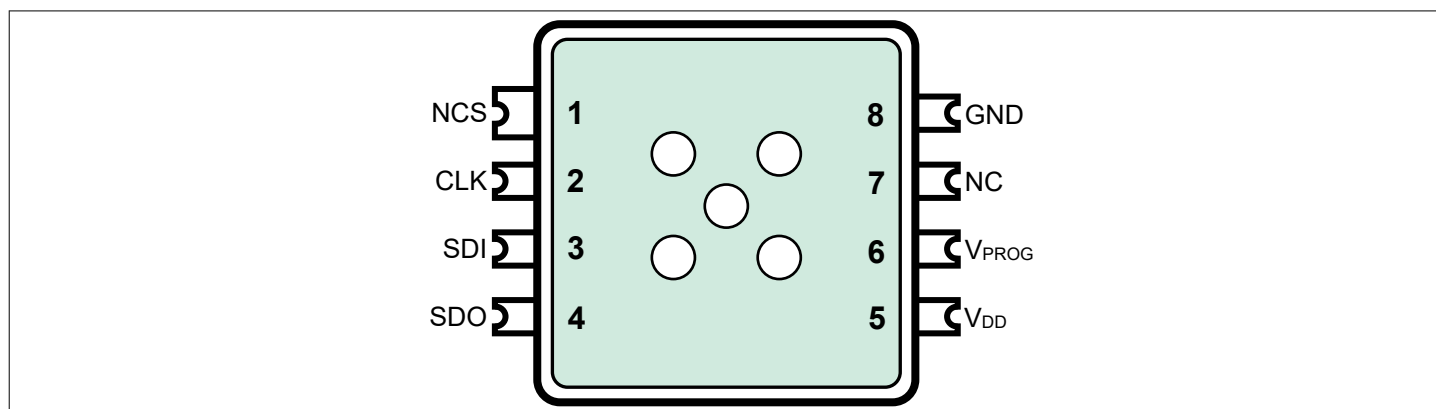

Figure 2 Pin configuration (top view, figure not to scale)

The table below shows the pin description.

Table 1 Pin description

Pin No.	Name	Function	Comment
1	NCS	Not-Chip-Select (active-low)	Communication is enabled when NCS is low
2	CLK	Serial Clock	External clock for serial communication
3	SDI	Serial Data In	Serial data input (e.g. from a controller)
4	SDO	Serial Data Out	Tri-state serial data output
5	V _{DD}	Supply voltage	–
6	V _{PROG}	Programming Voltage	Only required during EEPROM programming and Programming Mode entering
7	NC	Not connected	Pin is not bonded
8	GND	Ground	–

3 General product characteristics

3.1 Absolute maximum ratings

Table 2 Absolute maximum ratings

Parameter	Symbol	Values			Unit	Note or condition
		Min.	Typ.	Max.		
Maximum supply voltage range	V_{DD_max}	-0.3	-	5.5	V	
Maximum voltage range on any pin	V_{in_max}	-0.3	-	5.5	V	
Maximum voltage range on any pin (short term)	$V_{in_max_short}$	-0.3	-	6.0	V	Limited time: Max. 300s
Maximum voltage range at output pins	V_{out_max}	-0.3	-	$V_{DD} + 0.3$	V	
Storage temperature	T_S	-40	-	150	°C	
Maximum operating temperature range	T_{a_max}	-40	-	140	°C	Limited time: Max. 200h
Maximum input pressure range	P_{amb_max}	10	-	300	kPa	
Maximum input pressure range (short term)	$P_{amb_max_short}$	10	-	600	kPa	Limited time: Max. 300s
ESD robustness - HBM	V_{ESD_HBM}	-2000	-	2000	V	According to ANSI/ESDA/JEDEC JS-001
ESD robustness pins 1, 4, 5, 8 - CDM	V_{ESD_CDMc}	-750	-	750	V	According to ANSI/ESDA/JEDEC JS-002
ESD robustness pins 2, 3, 6, 7 - CDM	V_{ESD_CDMo}	-500	-	500	V	According to ANSI/ESDA/JEDEC JS-002

Attention: Stresses above those listed under “Absolute Maximum Ratings” may cause permanent damage to the device. This is a stress rating only and functional operation of the device at these or any other conditions above those indicated in the section “functional range” of this data sheet is not implied. Furthermore, only single error cases are assumed. More than one stress/error case may also damage the device. Exposure to absolute maximum rating conditions for extended periods may affect device reliability. During absolute maximum rating overload conditions the voltage on VDD pins with respect to ground (GND) must not exceed the values defined by the absolute maximum ratings. Lifetime statements are an anticipation based on an extrapolation of Infineon’s qualification test results. The actual lifetime of a component depends on its form of application and type of use etc. and may deviate from such statement. Lifetime statements shall in no event extend the agreed warranty period.

3.2 Functional range

The following functional range must not be exceeded in order to ensure correct operation of the device. All parameter specified in the following sections refer to these operation conditions unless otherwise indicated.

Table 3 Functional range

Parameter	Symbol	Values			Unit	Note or condition
		Min.	Typ.	Max.		
Supply voltage	V_{DD}	3.0	–	5.25	V	
Supply undervoltage	V_{DD_UV}	V_{UVR_max}	–	V_{DD_min}	V	Undervoltage range, reduced performance (see Characteristics in Undervoltage Range)
Supply voltage power up/power down gradient	V_{grad}	1E-5	–	1E4	V/ms	
Input voltage for high level at pins NCS, CLK & SDI	V_{high_in}	1.8	–	$V_{DD} + 0.3$	V	Not valid in Power-Down mode
Input voltage for high level at pins NCS, CLK & SDI (Power-Down mode)	$V_{high_in_pd}$	2.3	–	$V_{DD} + 0.3$	V	Not valid during normal operation
Input voltage for low level at pins NCS, CLK & SDI	V_{low_in}	-0.3	–	0.8	V	
Output voltage for low level at pin SDO	V_{low_out}	–	–	0.4	V	Test current (sink) at pin SDO is 2.0mA
Output voltage for high level at pin SDO	V_{high_out}	$V_{DD} - 0.4$	–	V_{DD}	V	Test current (source) at pin SDO is 2.0mA
Ambient operating temperature range	T_a	-40	–	125	°C	
Thermal resistance (junction-ambient)	R_{thJA}	250	–	350	K/W	Thermal resistance between die and T_{amb} (measured acc. JESD51-2)

4 Product features

4.1 Characteristics

4.1.1 Electrical characteristics

Table 4 Electrical characteristics

Parameter	Symbol	Values			Unit	Note or condition
		Min.	Typ.	Max.		
Undervoltage reset/ release level	V_{UVR}	2.1	–	2.7	V	
Undervoltage reset hysteresis	V_{UVR_Hyst}	100	–	300	mV	
Supply current into VDD	I_{VDD}	–	–	3.5	mA	Without SPI communication
Supply current into VDD during power-down mode (quiescent current)	I_{VDD_PD}	–	–	10	μ A	
Pressure signal path settling time	t_{path_pres}	–	–	5	ms	Pressure accuracy within specification
Temperature signal path settling time	t_{path_temp}	–	–	5	ms	Temperature accuracy within specification
Start-up time (with self diagnosis)	$t_{start-up_wd}$	–	–	10	ms	No SPI communication possible After $t_{start-up_wd}$ within full specification Configuration Parameter $power_up_{diag_en} = 1$
Start-up time (without self diagnosis)	$t_{start-up_wod}$	–	–	5	ms	No SPI communication possible After $t_{start-up_wod}$ within full specification Configuration Parameter $power_up_{diag_en} = 0$
Power down wake- up time (with self diagnosis)	$t_{PD_start-up_wd}$	–	–	10	ms	Configuration Parameter $wup_{diag_en} = 1$
Power down wake- up time (without self diagnosis)	$t_{PD_start-up_wod}$	–	–	5	ms	Configuration Parameter $wup_{diag_en} = 0$
Capacitive load at pins NCS, CLK & SDI	C_{load_in}	–	–	14	pF	
Capacitive load at pin SDO	C_{load_out}	–	–	19	pF	

(table continues...)

Table 4 (continued) **Electrical characteristics**

Parameter	Symbol	Values			Unit	Note or condition
		Min.	Typ.	Max.		
Tri-state leakage current	I_{SDO}	-5	-	5	μA	NCS = high $V_{DD} = 5\text{V}$
Hysteresis of input voltage at pins NCS, CLK & SDI	V_{SPL_Hys}	100	-	-	mV	
Current sink for NCS, CLK & SDI (each pin) - V_{low_in}	I_{SPL_in}	-100	-	-5	μA	$V_{low_in} = 0\text{V}$ No back biasing Not valid in Power-Down mode
Current sink for NCS, CLK & SDI (each pin) - V_{high_in}	I_{SPL_in}	-	-	5	μA	$V_{high_in} = 5\text{V}$ No back biasing

4.1.2 Transfer function pressure characteristics

Table 5 **Transfer function pressure characteristics**

Parameter	Symbol	Values			Unit	Note or condition
		Min.	Typ.	Max.		
Ambient operating pressure range	p_{amb}	40	-	115	kPa	
Accuracy pressure central temperature range	acc_p	-1.0	-	1.0	kPa	$T_a = 0^\circ\text{C}$ to 85°C ; additional drift from specifications for 24 hours after reflow soldering.
Accuracy pressure low temperature range	acc_{p_Tlow}	-1.5	-	1.5	kPa	$T_a = -40^\circ\text{C}$; additional drift from specifications for 24 hours after reflow soldering.
Accuracy pressure high temperature range	acc_{p_Thigh}	-1.5	-	1.5	kPa	$T_a = 125^\circ\text{C}$; additional drift from specifications for 24 hours after reflow soldering.

Note: *Drift from specifications after reflow soldering or when device is exposed to extreme temperature conditions for a maximum duration of 24h after reflow soldering in standard conditions (25°C, 100kPa).*

Attention: *The device is sensitive to light incident to the pressure port. All specifications are valid for an illuminance of less than 1 lx.*

4.1.3 Transfer function temperature characteristics

Table 6 Transfer function temperature characteristics

Parameter	Symbol	Values			Unit	Note or condition
		Min.	Typ.	Max.		
Accuracy temperature low	acc_{T_low}	-5.0	–	5.0	°C	$T_a = -40^\circ\text{C}$ to 25°C After device self-heating within acc_{T_low}
Accuracy temperature central	acc_{T_cen}	-3.0	–	3.0	°C	$T_a = 25^\circ\text{C}$ to 85°C ; After device self-heating within acc_{T_cen}
Accuracy temperature high	acc_{T_high}	-3.5	–	3.5	°C	$T_a = 85^\circ\text{C}$ to T_{a_max} ; After device self-heating within acc_{T_high}

4.1.4 Undervoltage range characteristics

Table 7 Undervoltage range characteristics

Parameter	Symbol	Values			Unit	Note or condition
		Min.	Typ.	Max.		
Clock frequency of SPI interface	f_{SPI}	0.1	–	2.5	MHz	Undervoltage range V_{DD_UV}
Accuracy pressure central temperature range	acc_p	-2.0	–	2.0	kPa	$T_a = 0^\circ\text{C}$ to 85°C Undervoltage range V_{DD_UV}
Accuracy pressure low temperature range	acc_{p_Tlow}	-3.0	–	3.0	kPa	$T_a = -40^\circ\text{C}$ to 0°C Undervoltage range V_{DD_UV}
Accuracy pressure high temperature range	acc_{p_Thigh}	-3.0	–	3.0	kPa	$T_a = 85^\circ\text{C}$ to 125°C Undervoltage range V_{DD_UV}
Output voltage for low level at pin SDO	V_{low_out}	–	–	0.4	V	Test current (sink) at pin SDO is 1.5mA Undervoltage range V_{DD_UV}
Output voltage for high level at pin SDO	V_{high_out}	$V_{DD} - 0.4$	–	V_{DD}	V	Test current (source) at pin SDO is 1.5mA Undervoltage range V_{DD_UV}

4.1.5 SPI timing

Table 8 SPI timing

Parameter	Symbol	Values			Unit	Note or condition
		Min.	Typ.	Max.		
Clock frequency of SPI interface	f_{SPI}	0.1	–	5	MHz	

(table continues...)

Table 8 (continued) SPI timing

Parameter	Symbol	Values			Unit	Note or condition
		Min.	Typ.	Max.		
Transition speed at SDO (low capacitive load)	$t_{SDO_trans_l}$	5	–	30	ns	$V_{DD} = 5V$ $C_{load} = 50pF$ Rising edge = 20% - 80% Falling edge = 80% - 20%
Transition speed at SDO (high capacitive load)	$t_{SDO_trans_h}$	5	–	50	ns	$V_{DD} = 5V$ $C_{load} = 150pF$ Rising edge = 20% - 80% Falling edge = 80% - 20%
Clock high time	t_{clh}	75	–	–	ns	
Clock low time	t_{cll}	75	–	–	ns	
NCS filter time	t_{fNCS}	10	–	60	ns	Pulses below the NCS filter time will be ignored
Delay between NCS falling edge and SDO active	t_{csdv}	–	–	75	ns	
Delay between CLK rising edge and start SDO data	t_{pclid}	–	–	50	ns	CLK to data at 10% of SDO rising edge $C_{load} = 120pF$
Delay between CLK low and start NCS low	t_{sclch}	75	–	–	ns	
Delay between NCS low and rising edge 1st CLK pulse	t_{hclcl}	75	–	–	ns	
Time between start SDI data and falling edge CLK	t_{sclcl}	15	–	–	ns	
Time between falling edge CLK and end SDI data	t_{hclcl}	15	–	–	ns	
Delay between falling edge last CLK pulse and rising edge NCS	t_{sclcl}	100	–	–	ns	
Delay between rising edge NCS and rising edge CLK pulse	t_{hclch}	100	–	–	ns	

(table continues...)

Table 8 (continued) SPI timing

Parameter	Symbol	Values			Unit	Note or condition
		Min.	Typ.	Max.		
Delay between rising edge NCS and end SDO data	$t_{p\text{chdz}}$	–	–	75	ns	
Time between rising edge NCS and falling edge next NCS	$t_{on\text{nCS}}$	300	–	–	ns	
Minimum input rise/fall time	$t_{\text{SPI_switch}}$	–	–	2	ns	20% - 80% at SDI, CLK, NCS
Maximum output over-/undershoot	$V_{\text{SDO_ovun}}$	-200	–	200	mV	$V_{\text{DD}} = 5\text{V}$ $C_{\text{load}} = 150\text{pF}$ Trace inductance < 400nH
Valid pressure/temperature value after trigger diagnostic command	$t_{\text{diag_wait}}$	–	–	10	ms	

4.2 Functional description

4.2.1 Transfer function pressure

The KP46x pressure calibration is adjusted with the parameters S_p and $offs_p$. The formula in order to calculate the ambient pressure based on these parameters and the sensor output is shown below:

$$p_{\text{amb}} = \frac{(out_p - offs_p)}{S_p} \quad (1)$$

The KP46x device is fully calibrated on delivery. The sensor has a linear transfer function between the applied pressure and the digital output signal. The device provides an absolute pressure value by triggering the [Acquire Pressure Command](#).

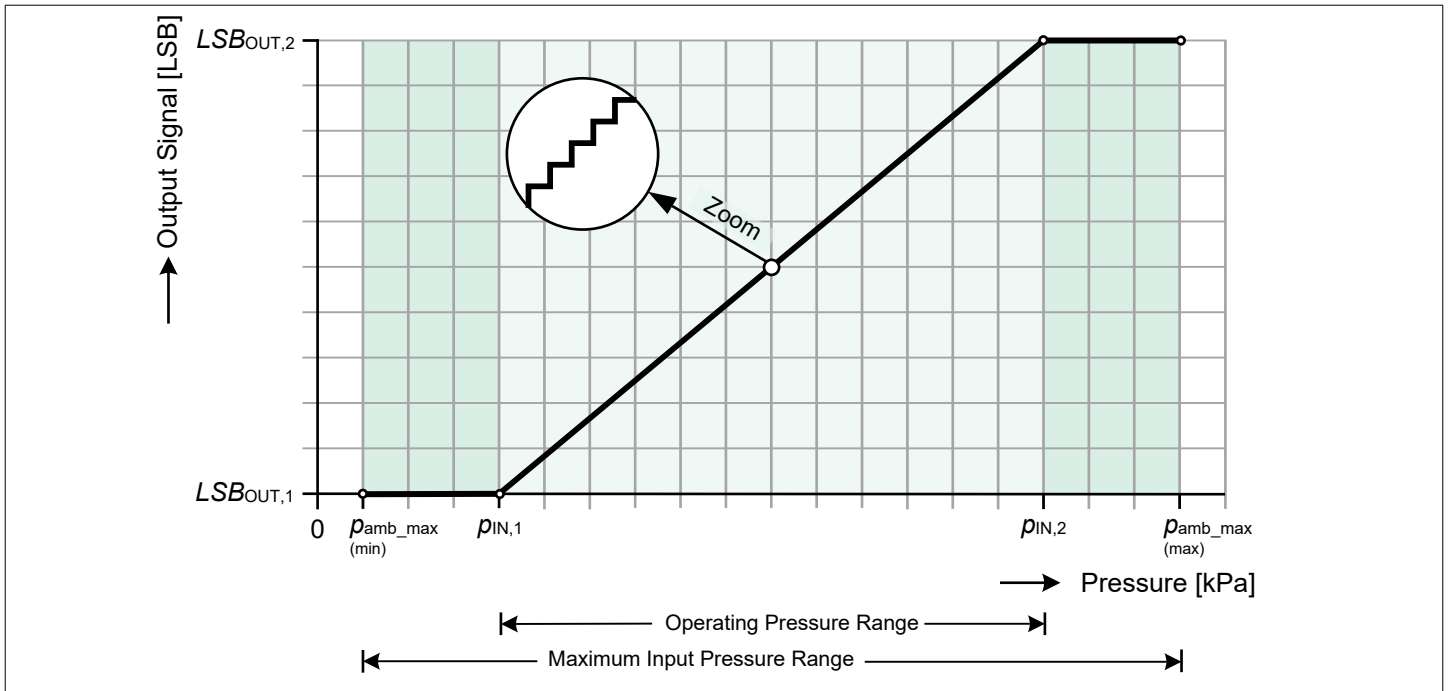

Figure 3 Pressure transfer function

Table 9 Pressure transfer function characteristics (10-bit)

Pressure			Output Code		
Symbol	Values (Typ.)	Unit	Symbol	Values (Typ.)	Unit
$\rho_{IN,1}$	40	kPa	$LSB_{OUT,1}$	0	LSB
$\rho_{IN,2}$	115	kPa	$LSB_{OUT,2}$	1023	LSB

Table 10 Gain and offset pressure transfer function (10-bit)

Gain and Offset

Symbol	Values (Typ.)	Unit
S_p	13.64	LSB/kPa
$offs_p$	-545.6	LSB

Table 11 Pressure transfer function characteristics (12-bit)

Pressure			Output Code		
Symbol	Values (Typ.)	Unit	Symbol	Values (Typ.)	Unit
$\rho_{IN,1}$	40	kPa	$LSB_{OUT,1}$	0	LSB
$\rho_{IN,2}$	115	kPa	$LSB_{OUT,2}$	4095	LSB

Table 12 Gain and offset pressure transfer function (12-bit)

Gain and Offset

Symbol	Values (Typ.)	Unit
S_p	54.6	LSB/kPa

(table continues...)

Table 12 (continued) Gain and offset pressure transfer function (12-bit)

Gain and Offset		
$offs_p$	-2184	LSB

Table 13 Pressure transfer function characteristics (14-bit)

Pressure			Output Code		
Symbol	Values (Typ.)	Unit	Symbol	Values (Typ.)	Unit
$p_{IN,1}$	40	kPa	$LSB_{OUT,1}$	0	LSB
$p_{IN,2}$	115	kPa	$LSB_{OUT,2}$	16383	LSB

Table 14 Gain and offset pressure transfer function (14-bit)

Gain and Offset		
Symbol	Values (Typ.)	Unit
S_p	218.44	LSB/kPa
$offs_p$	-8737.6	LSB

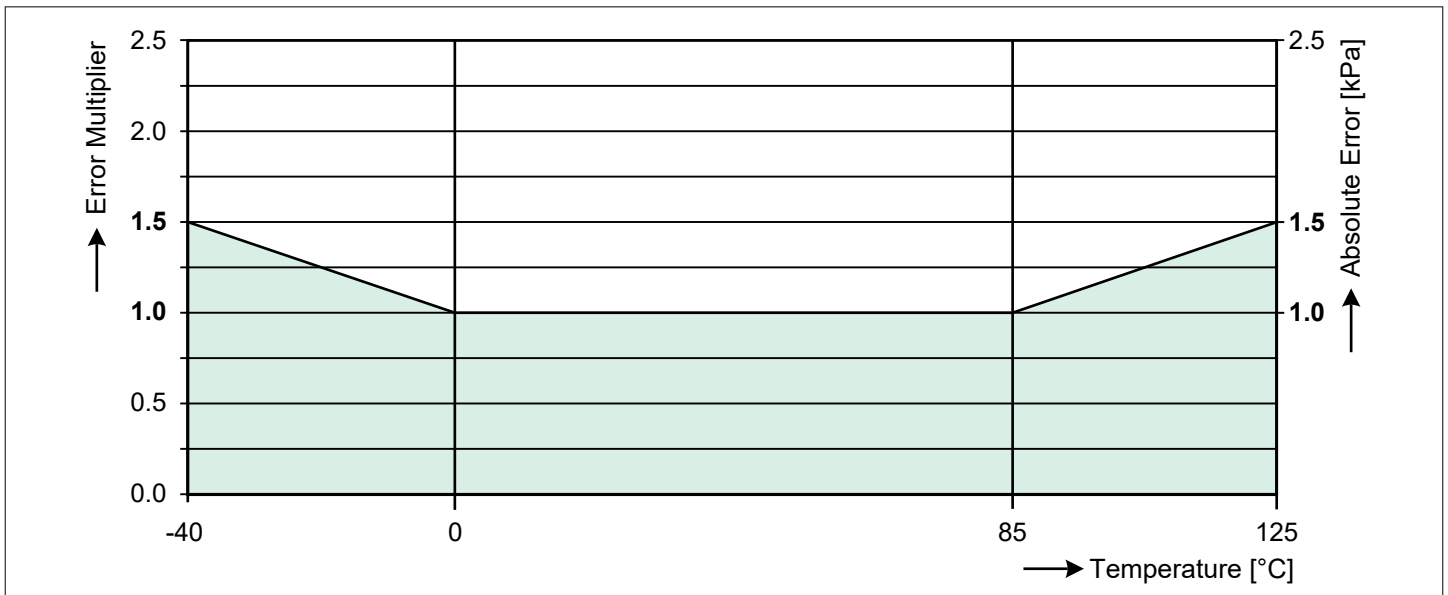

Figure 4 Accuracy for pressure acquisition

4.2.2 Transfer function temperature

The KP46x temperature calibration is adjusted with the parameters S_T and $offs_T$. The formula in order to calculate the ambient temperature based on these parameters and the sensor output is shown below:

$$T_{amb} = \frac{(out_T - offs_T)}{S_T} \quad (2)$$

The KP46x device is fully calibrated on delivery. The sensor has a linear transfer function between the applied temperature and the digital output signal. The device provides an ambient temperature value by triggering the [Acquire Temperature Command](#).

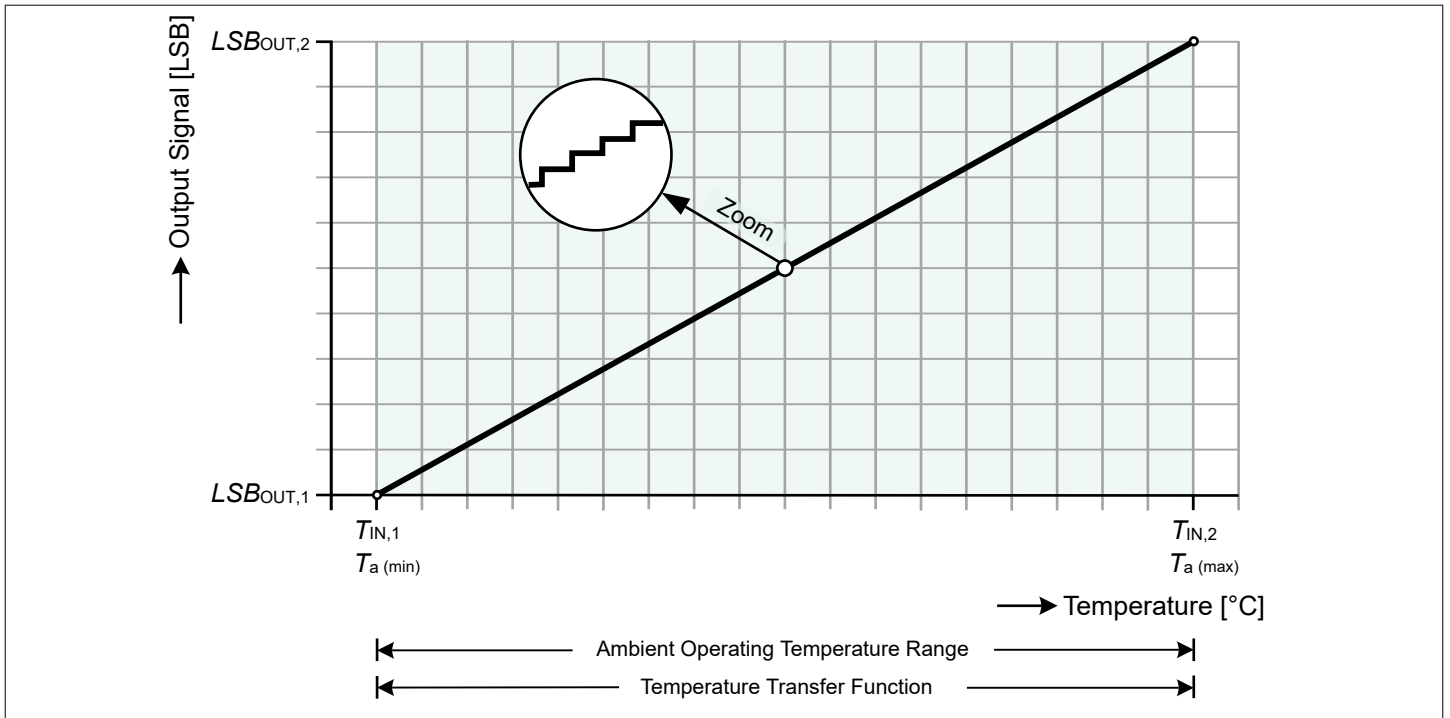

Figure 5 Temperature transfer function

Table 15 Temperature transfer function characteristics (10-bit)

kp25x _{t_compat}	vdd _{range}	V _{DD}		Temperature			Output Code		
		Bit	Values (Typ.)	Unit	Symbol	Values (Typ.)	Unit	Symbol	Values (Typ.)
0	0	3.3	V	T _{IN,1}	-40	°C	LSB _{OUT,1}	0	LSB
				T _{IN,2}	125	°C	LSB _{OUT,2}	1023	LSB
		5.0	V	T _{IN,1}	-40	°C	LSB _{OUT,1}	0	LSB
				T _{IN,2}	125	°C	LSB _{OUT,2}	1023	LSB
1	-	3.3	V	T _{IN,1}	-38.5	°C	LSB _{OUT,1}	0	LSB
				T _{IN,2}	126.5	°C	LSB _{OUT,2}	1023	LSB
		5.0	V	T _{IN,1}	-40	°C	LSB _{OUT,1}	0	LSB
				T _{IN,2}	125	°C	LSB _{OUT,2}	1023	LSB

Table 16 Gain and offset of temperature transfer function (10bit)

kp25x _{t_compat}	V _{DD}		Gain and offset		
	Values (Typ.)	Unit	Symbol	Values (Typ.)	Unit
1	3.3 / 5.0	V	S _T	6.2	LSB/°C
	5.0		offs _{T_5.0}	248	LSB
	3.3		offs _{T_3.3}	238.7	LSB
0	3.3 / 5.0	V	S _T	6.2	LSB/°C
			offs _T	248	LSB

Table 17 Temperature transfer function characteristics (12-bit)

$kp25x_t_compat$	vdd_{range}	V_{DD}		Temperature			Output Code		
Bit	Bit	Values (Typ.)	Unit	Symbol	Values (Typ.)	Unit	Symbol	Values (Typ.)	Unit
0	0	3.3	V	$T_{IN,1}$	-40	°C	$LSB_{OUT,1}$	0	LSB
				$T_{IN,2}$	125	°C	$LSB_{OUT,2}$	4095	LSB
	1	5.0	V	$T_{IN,1}$	-40	°C	$LSB_{OUT,1}$	0	LSB
				$T_{IN,2}$	125	°C	$LSB_{OUT,2}$	4095	LSB
1	-	3.3	V	$T_{IN,1}$	-38.5	°C	$LSB_{OUT,1}$	0	LSB
				$T_{IN,2}$	126.5	°C	$LSB_{OUT,2}$	4095	LSB
	-	5.0	V	$T_{IN,1}$	-40	°C	$LSB_{OUT,1}$	0	LSB
				$T_{IN,2}$	125	°C	$LSB_{OUT,2}$	4095	LSB

Table 18 Gain and offset of temperature transfer function (12bit)

$kp25x_t_compat$	V_{DD}		Gain and offset		
Bit	Values (Typ.)	Unit	Symbol	Values (Typ.)	Unit
1	3.3 / 5.0	V	S_T	24.82	LSB/°C
	5.0		$offs_{T_{5.0}}$	992.73	LSB
	3.3		$offs_{T_{3.3}}$	955.5	LSB
0	3.3 / 5.0	V	S_T	24.82	LSB/°C
			$offs_T$	992.73	LSB

Table 19 Temperature transfer function characteristics (14-bit)

$kp25x_t_compat$	vdd_{range}	V_{DD}		Temperature			Output Code		
Bit	Bit	Values (Typ.)	Unit	Symbol	Values (Typ.)	Unit	Symbol	Values (Typ.)	Unit
0	0	3.3	V	$T_{IN,1}$	-40	°C	$LSB_{OUT,1}$	0	LSB
				$T_{IN,2}$	125	°C	$LSB_{OUT,2}$	16383	LSB
	1	5.0	V	$T_{IN,1}$	-40	°C	$LSB_{OUT,1}$	0	LSB
				$T_{IN,2}$	125	°C	$LSB_{OUT,2}$	16383	LSB
1	-	3.3	V	$T_{IN,1}$	-38.5	°C	$LSB_{OUT,1}$	0	LSB
				$T_{IN,2}$	126.5	°C	$LSB_{OUT,2}$	16383	LSB
	-	5.0	V	$T_{IN,1}$	-40	°C	$LSB_{OUT,1}$	0	LSB
				$T_{IN,2}$	125	°C	$LSB_{OUT,2}$	16383	LSB

Table 20 Gain and offset of temperature transfer function (14bit)

$kp25x_t_compat$	V_{DD}		Gain and offset		
Bit	Values (Typ.)	Unit	Symbol	Values (Typ.)	Unit

(table continues...)

When NCS is high, SDO is let in a high impedance state (no SPI communication is possible).

When the number of CLK period is different from 0 or multiple of 16, next SPI answer signalizes a communication error.

In case of no CLK edge when NCS is low, the transfer is considered as valid. The answer of last command is sent during next transfer.

The device is able to send a unique ID number, upon request. This Traceability-ID makes sure that all numbers for KP46x family are unique.

4.2.4.1 EEPROM programmability

The following parts of the EEPROM are user programmable via the SPI interface:

- Identifier response (spi_id: bit 0-7)
- SPI interface configuration:
 - $kp25x_{res_compat}$
 - vdd_{range}
 - $kp25x_{t_compat}$
- Start-up self diagnostics:
 - wup_{diag_en}
 - $power_up_{diag_en}$

4.2.4.2 Commands

The following commands are defined:

- Acquire identifier
- Acquire pressure (incl. the diagnosis pressure out of range, EEPROM check and last updated Diag1 & Diag2)¹⁾
- Acquire temperature (incl. the diagnosis pressure out of range, EEPROM check and last updated Diag1 & Diag2)¹⁾
- Trigger Power-Down mode (activates the power-down state)
- Trigger diagnosis (triggers Diag1, Diag2)
- Trigger programming mode (entry into programming mode only occurs with a high voltage level (>10V) on pin V_{PROG})

¹⁾ Last updated diagnosis information is only available if the Trigger Diagnosis Command (see [Chapter 4.2.4.6](#)) was sent at any time before and the diagnostic reset is not active (Reset-bit C12 = '1').

4.2.4.3 Command behaviour

The answer of the command sent in SPI frame N will be send in next SPI frame (N+1).

When a command (N) is sent and the processing of the previous command (N-1) has not finalized, the last command (N) will not interrupt the processing.

The diagnosis command triggers the Diag1 and Diag2 measurement; during the execution of the self diagnosis the pressure values (including out of range information) will not be updated.

The first answer of the sensor after power-on or reset is the identifier response (see [Chapter 4.2.4.8](#)) independent from the command.

4.2.4.4 Structure

The following structure is defined for an SPI command:

4 Product features

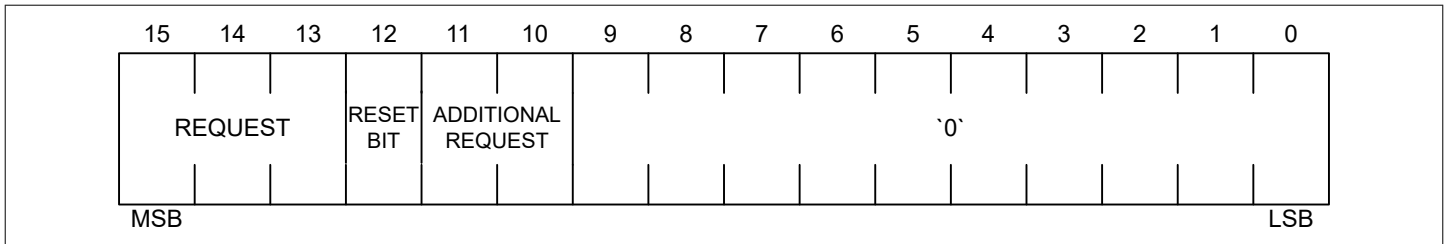

Figure 7 SPI command structure

The following structure is defined for a 10-bit SPI response:

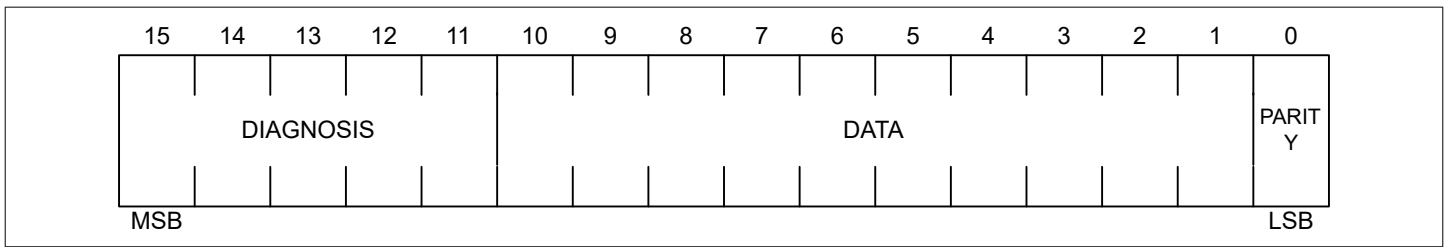

Figure 8 SPI response structure (10-bit)

This response structure is valid for the Acquire Pressure Command (10-bit), Acquire Temperature Command (10-bit) and Trigger Diagnosis Command (10-bit).

The following structure is defined for a 12-bit SPI response:

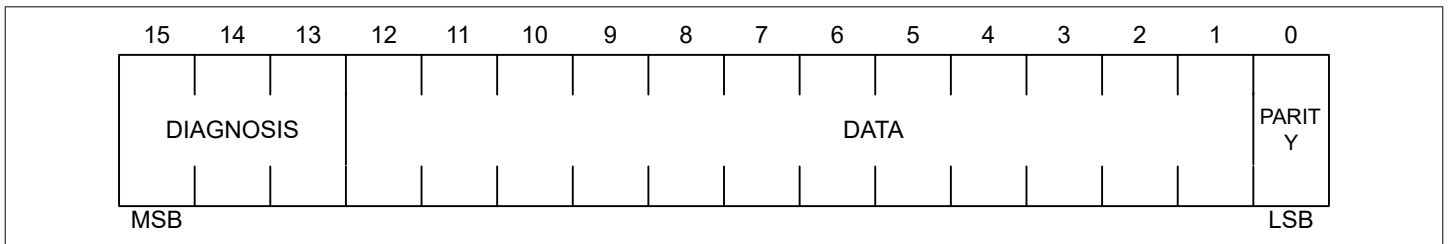

Figure 9 SPI response structure (12-bit)

This response structure is valid for the Acquire Pressure Command (12-bit), Acquire Temperature Command (12-bit) and Trigger Diagnosis Command (12-bit).

The following structure is defined for a 14-bit SPI response:

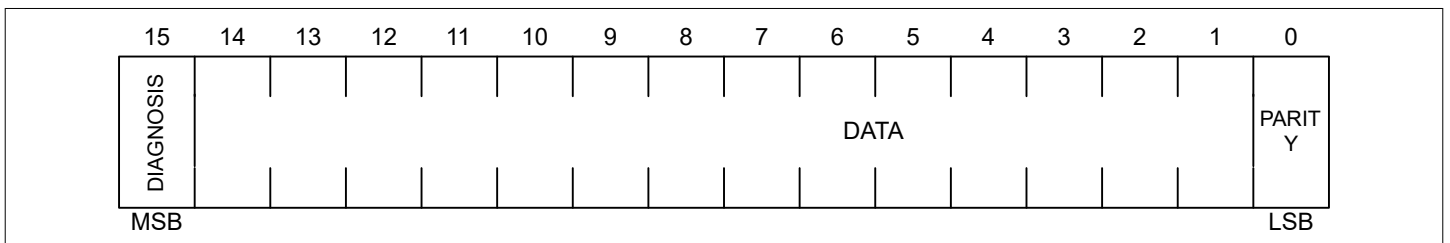

Figure 10 SPI response structure (14-bit)

This response structure is valid for the Acquire Pressure Command (14-bit), Acquire Temperature Command (14-bit) and Trigger Diagnosis Command (14-bit).

The following structure is defined for a SPI response for identifier:

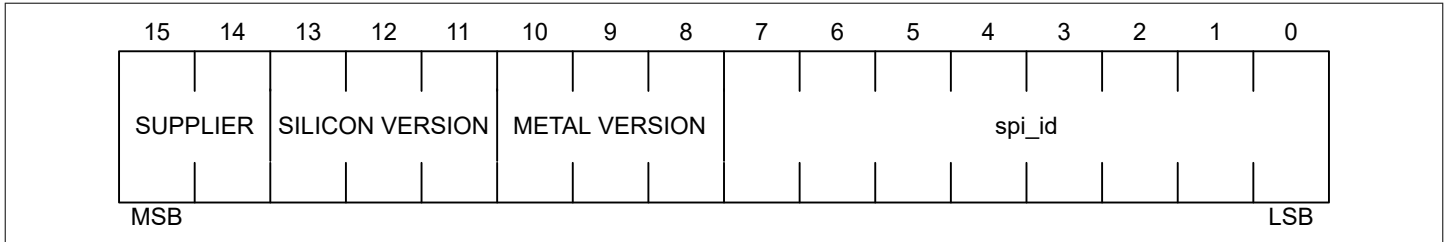

Figure 11 SPI response structure for identifier

4.2.4.5 Parity

The following SPI responses include an odd parity (LSB, [0]):

- Acquire Pressure
- Acquire Temperature
- Trigger Diagnosis
- Communication Error

The number of bits with the value one in the 16 bit response is odd (including the parity bit).

4.2.4.6 Command definition

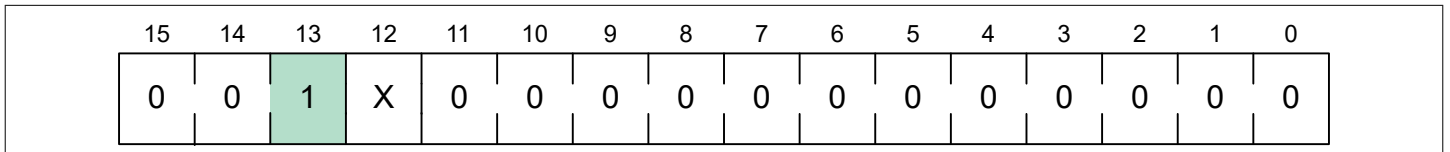

Figure 12 Acquire pressure command (10-bit) for $kp25x_{res_compat} = 0$

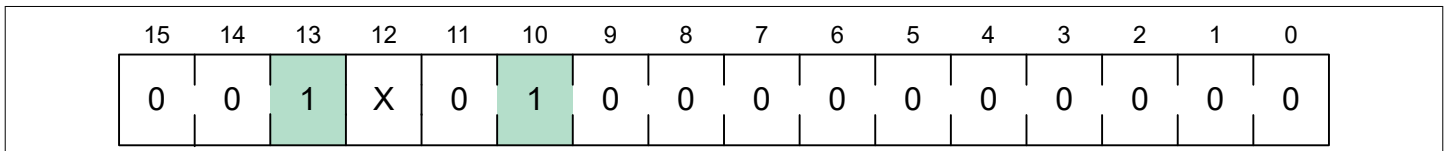

Figure 13 Acquire pressure command (10-bit) for $kp25x_{res_compat} = 1$

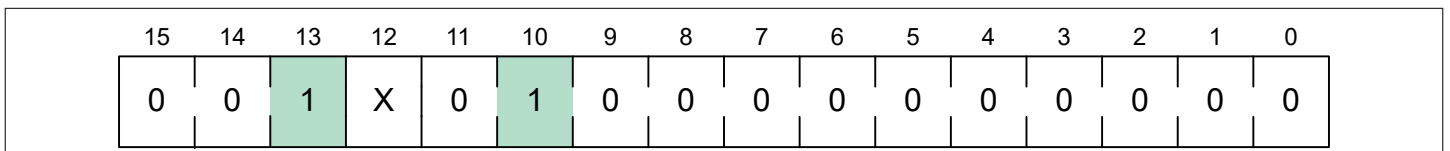

Figure 14 Acquire pressure command (12-bit) for $kp25x_{res_compat} = 0$

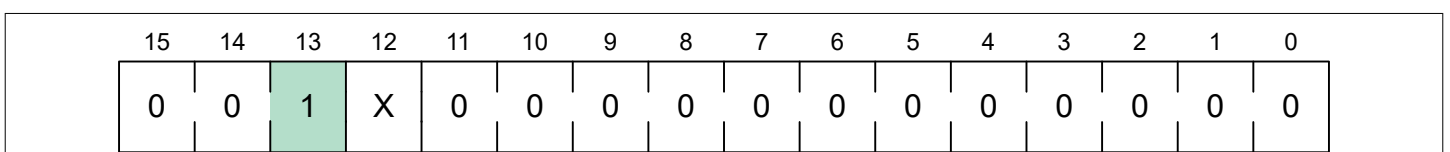

Figure 15 Acquire pressure command (12-bit) for $kp25x_{res_compat} = 1$

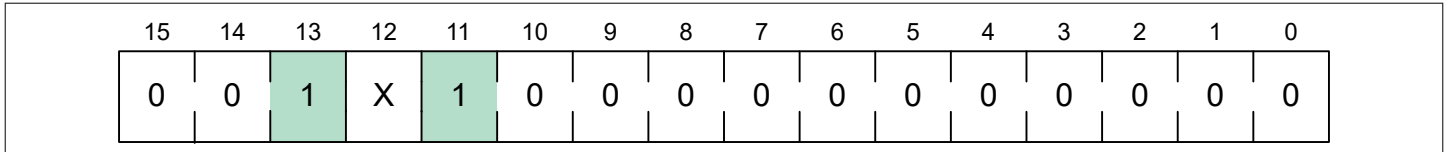

Figure 16 Acquire pressure command (14-bit)

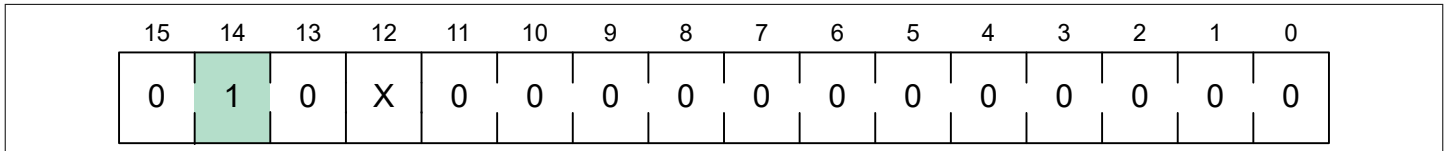

Figure 17 Acquire temperature command (10-bit) for $kp25x_{res_compat} = 0$

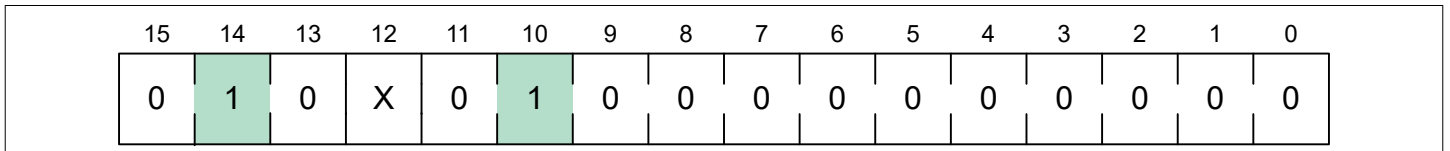

Figure 18 Acquire temperature command (10-bit) for $kp25x_{res_compat} = 1$

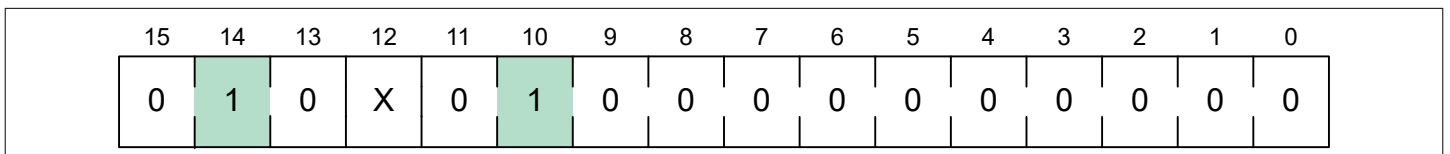

Figure 19 Acquire temperature command (12-bit) for $kp25x_{res_compat} = 0$

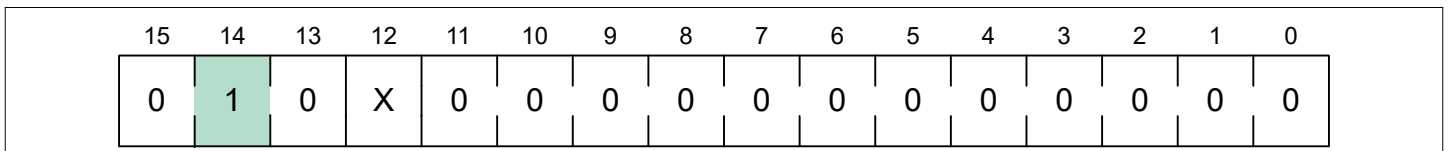

Figure 20 Acquire temperature command (12-bit) for $kp25x_{res_compat} = 1$

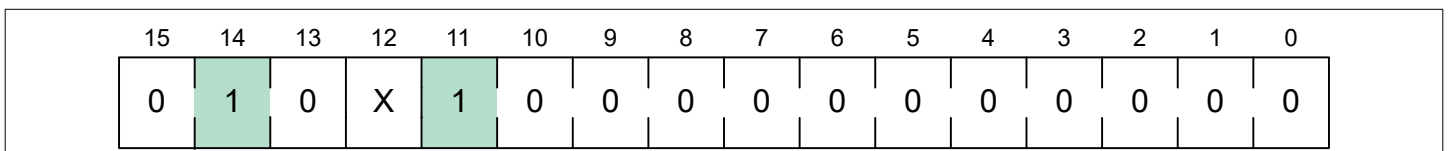

Figure 21 Acquire temperature command (14-bit)

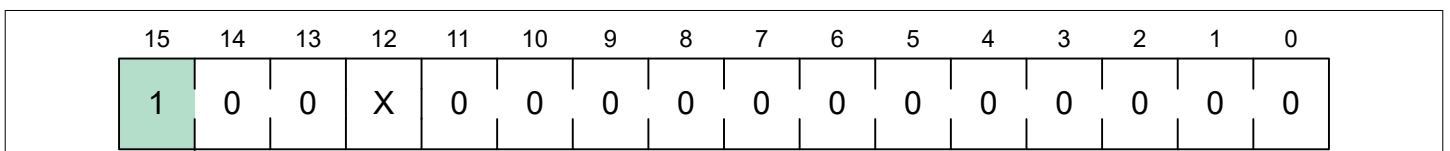

Figure 22 Trigger diagnosis command (10-bit) for $kp25x_{res_compat} = 0$

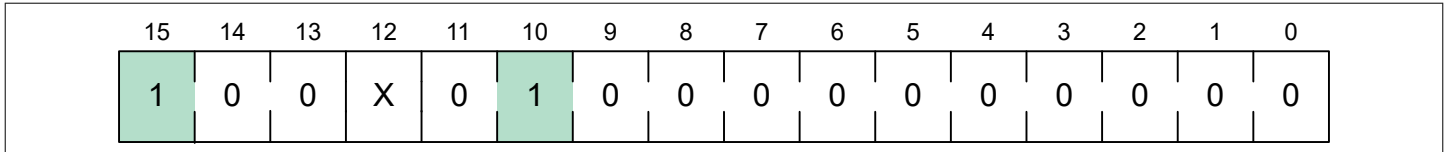

Figure 23 Trigger diagnosis command (10-bit) for $kp25x_{res_compat} = 1$

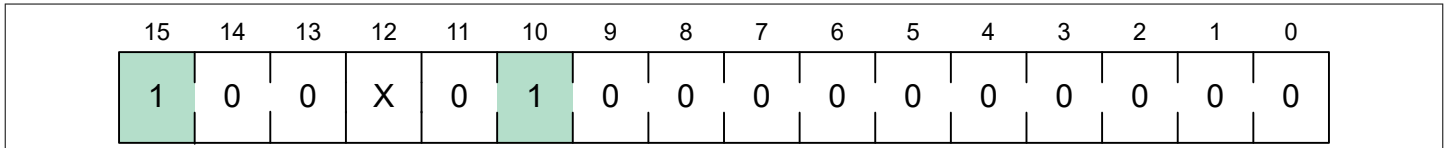

Figure 24 Trigger diagnosis command (12-bit) for $kp25x_{res_compat} = 0$

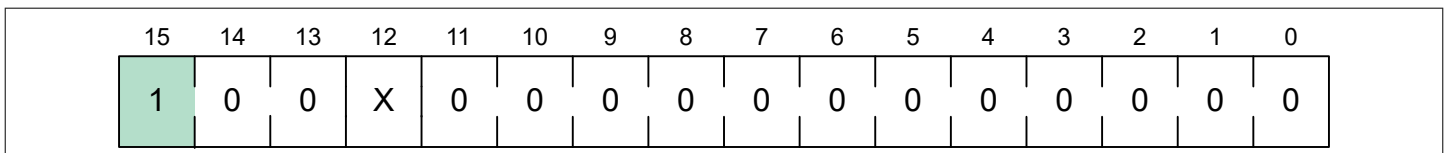

Figure 25 Trigger diagnosis command (12-bit) for $kp25x_{res_compat} = 1$

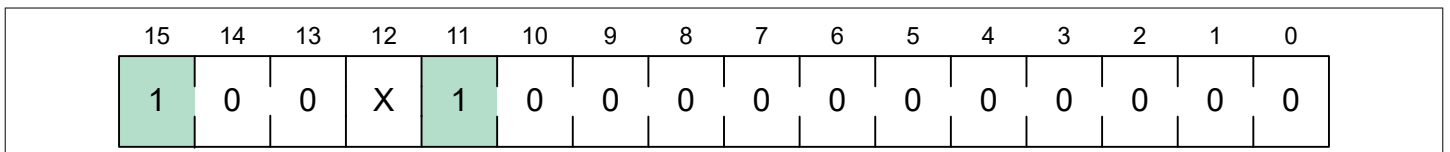

Figure 26 Trigger diagnosis command 14-bit

Note: After a Trigger Diagnostic Command the user has to wait the time t_{diag_wait} (see in table [SPI timing](#)) to acquire a valid pressure or temperature value.

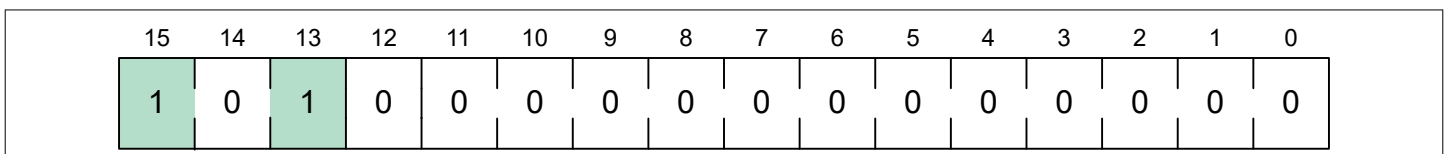

Figure 27 Trigger Power-Down Mode Command

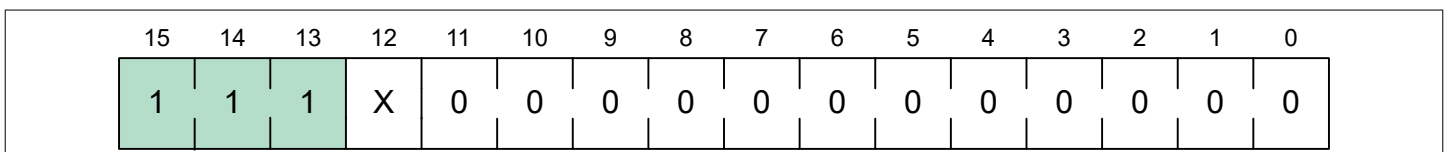

Figure 28 Acquire identifier command

Note: The Reset-bit (C12) determines how the diagnostic reset is handled.

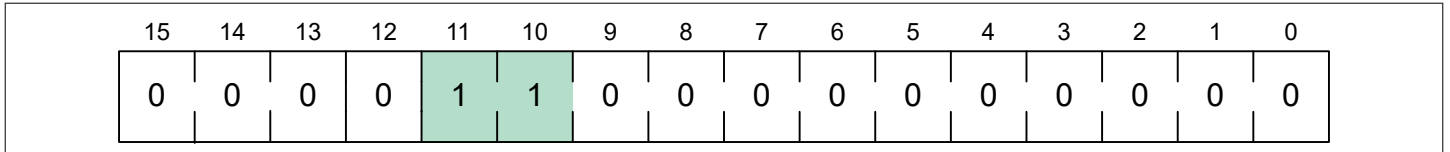

Figure 29 Trigger programming mode command

4.2.4.7 Communication error

In normal operation only the specified commands are valid. Every abnormality of these commands (e.g. unused command, other value of unused bits, number of clocks not equal to 16n with n = 1, 2, 3...) will result in a communication error. The response to a detected communication error is given below.

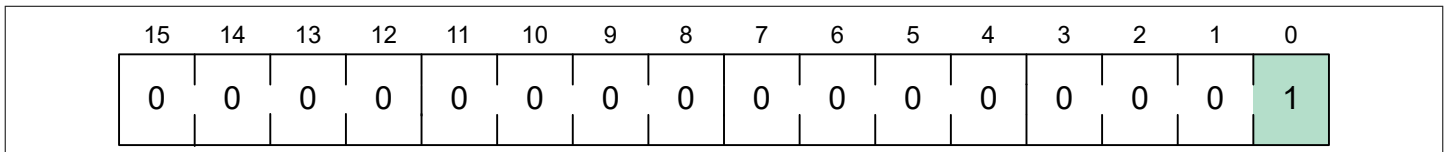

Figure 30 Response after a communication error

4.2.4.8 Identifier response definition

The response to an "Acquire Identifier Command" is a defined value for each derivate as stated below. With this response, the **KP46x** sensor can be identified when operated in a bus system with several different parts.

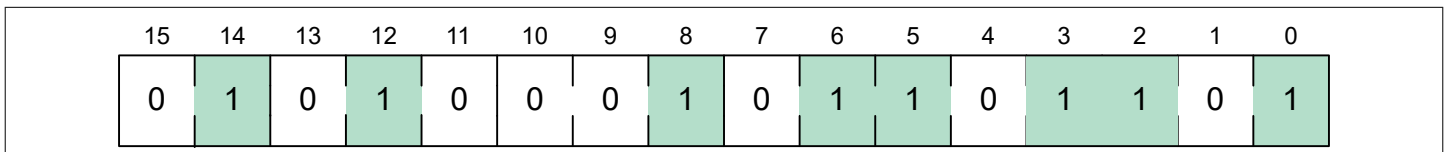

Figure 31 Identifier response definition

4.2.4.9 Single device operation

The figure below shows an example on how to connect a single device to a microcontroller. After NCS is pulled to low, the request command is sent to the sensor with the next 16 cycles of the CLK. The response of the sensor for the previous request command is returned at the same time.

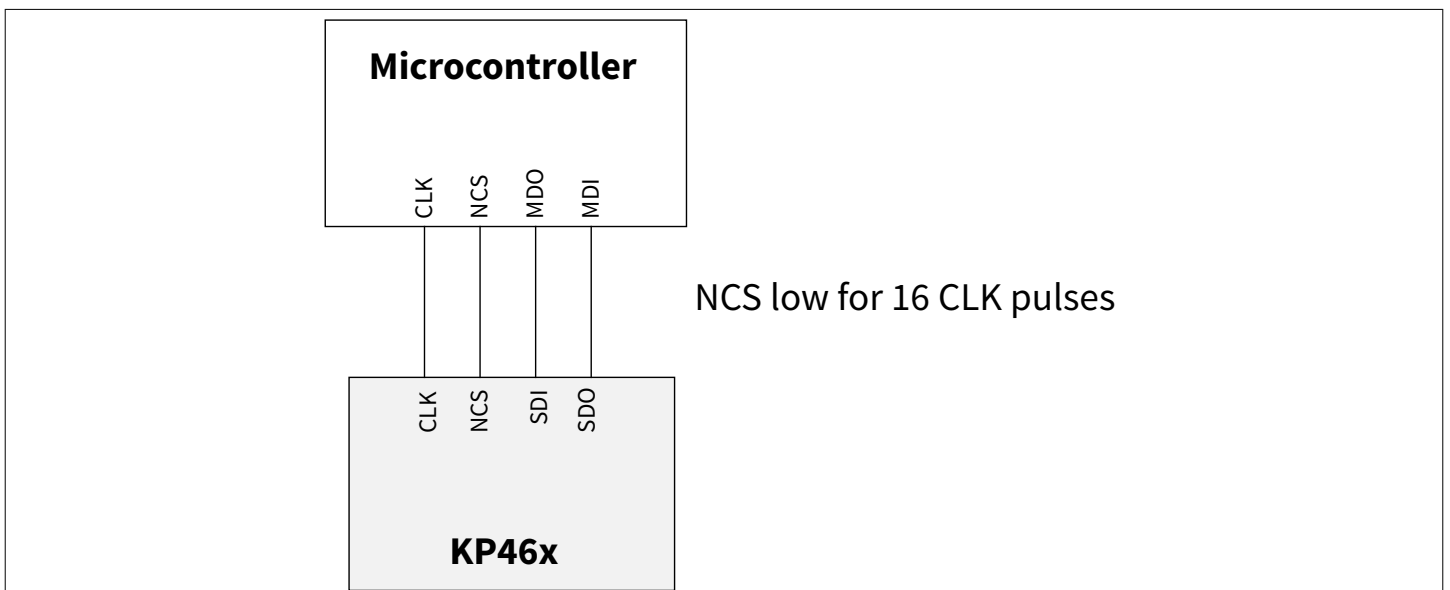

Figure 32 Example for single device operation

The SPI signal timing for single device operation is shown in the figure below.

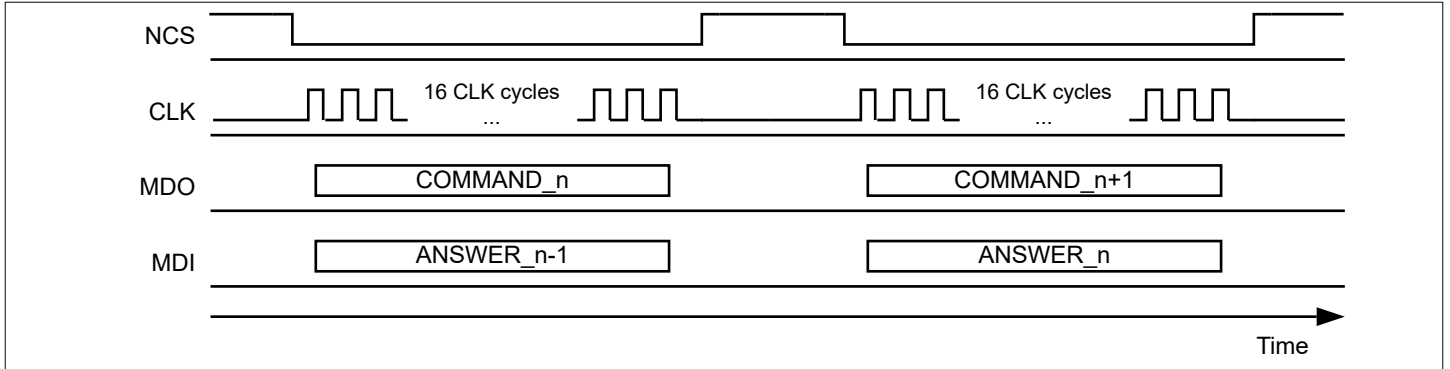

Figure 33 Example for single device signal diagram

4.2.4.10 Daisy chain operation

The daisy chain operation can be used to connect several devices to one SPI connection in order to save microcontroller pins. Please see Daisy Chain Operation Example for an example how to connect several devices to one microcontroller.

The number of devices connected in daisy chain operation is unlimited.

The figure below shows an example of a combination of daisy chain mode and parallel operation.

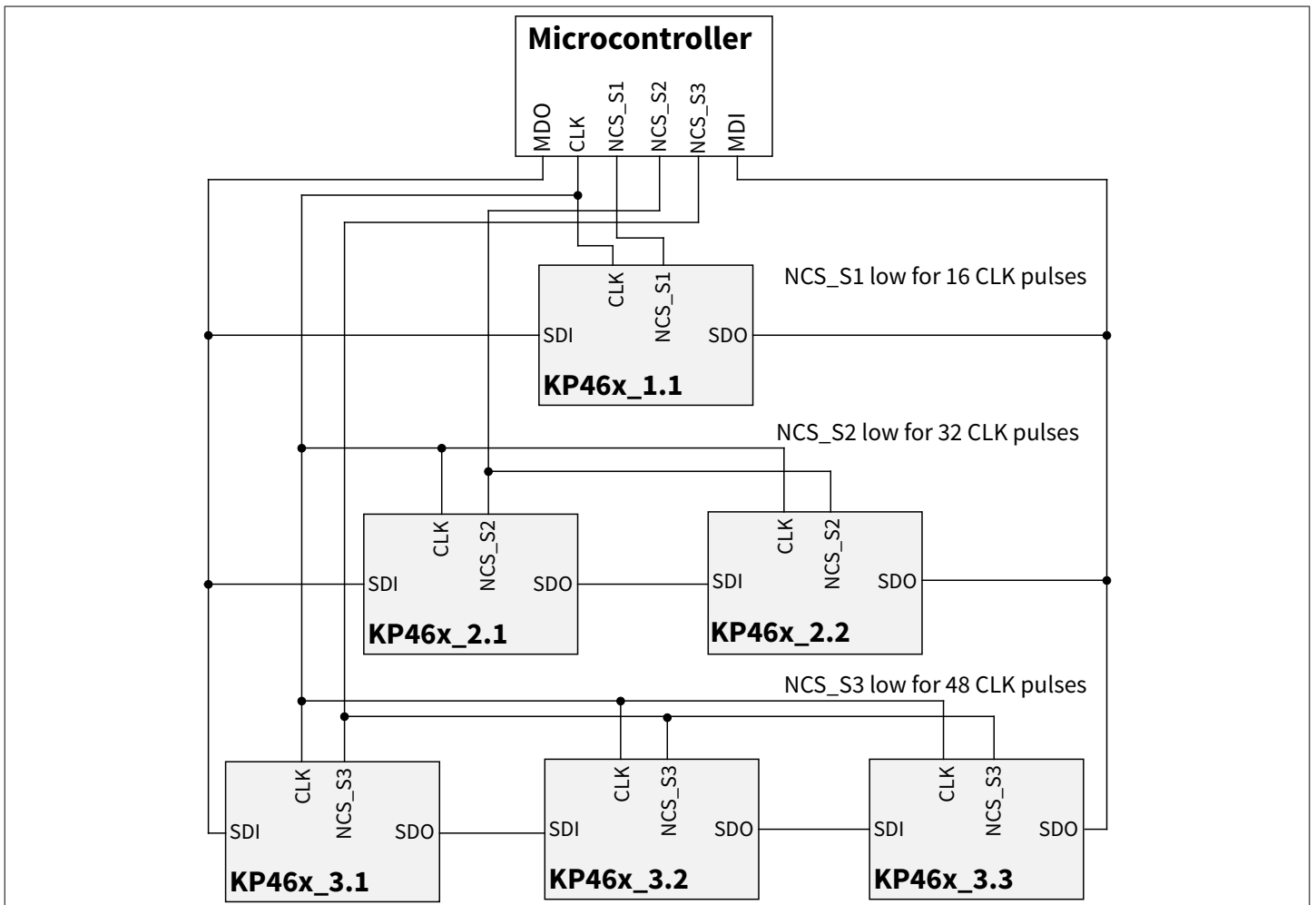

Figure 34 Example for daisy chain operation

*Note: Not all five sensors in this example could be addressed at once. Only one branch can be addressed at once (e.g. the **KP46x_2.x** branch). Finally only one NCS line can be low at the same time (NCS_S1, NCS_S2 or NCS_S3).*

The Example for daisy chain operation figure shows an example of a combination of daisy chain mode and parallel operation. The responding NCS line for the addressed sensor group must be low during the complete communication. During this time the provided number of clock pulses must be the multiplication result of 16 times the number of sensors in a daisy chain (e.g. 32 clock pulses for the KP46x_2.x branch in figure "Daisy Chain Operation Example"). It is important that NCS_S2.1 and NCS_S2.2 stay at the low level during the complete transmission. Therewith the sensor is able after receiving more than 16 clock pulses without a change in the NCS signal to switch automatically in daisy chain mode (in this example the first received 16 bit input data by the sensor S2.1 will be clocked to the output of sensor S2.1 with the last 16 clock pulses). The figure "Daisy Chain Operation Signal Diagram" shows the whole signal diagram.

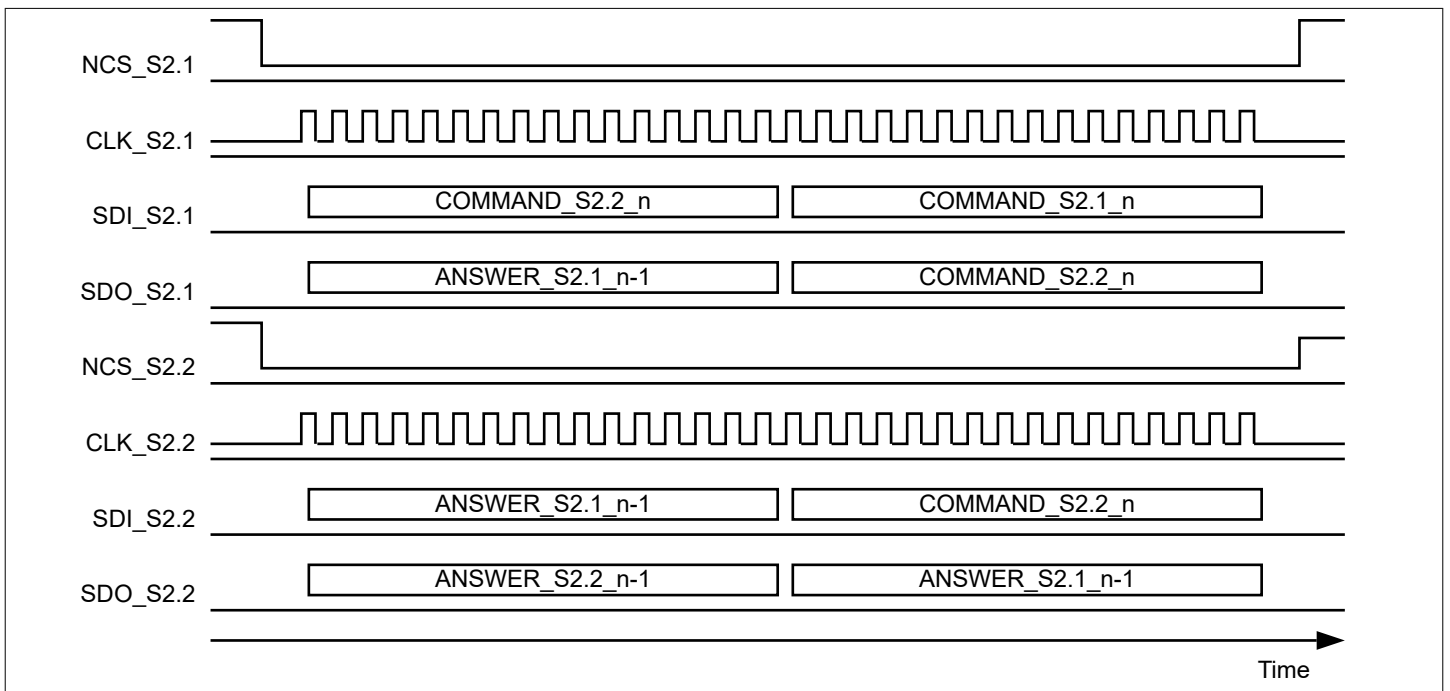

Figure 35 Example for daisy chain signal diagram

It is important that the number of clock pulses is a multiple of 16. Otherwise all commands for a daisy chain branch will be identified as invalid commands and the response of all sensors on this branch will be the Communication Error Response.

4.2.4.11 SPI configuration parameters

The following parameters of the digital interface are user-configurable:

Table 21 Interface configuration parameters

Configuration parameter	Symbol	Nominal range	Unit	Step width	Default	Note
Start-up diagnostics - VDD Power-On	$power_up_{diag_en}$	0 or 1	bit	-	1	<p>Can be adjusted by changing the corresponding EEPROM bit:</p> <ul style="list-style-type: none"> 0: Deactivated self diagnostics during V_{DD} start-up 1: Activated self diagnostics during V_{DD} start-up <p>This influences the average power consumption of the device.</p>
Start-up diagnostic - PD Power-Up	wup_{diag_en}	0 or 1	bit	-	1	<p>Can be adjusted by changing the corresponding EEPROM bit:</p> <ul style="list-style-type: none"> 0: Deactivated self diagnostics during PD start-up 1: Activated self diagnostics during PD start-up <p>This influences the average power consumption of the device.</p>
VDD range	vdd_{range}	0 or 1	bit	-	1	<p>Can be adjusted by changing the corresponding EEPROM bit:</p> <ul style="list-style-type: none"> 0: 3.3 V supply voltage for the device 1: 5.0 V supply voltage for the device
Temperature compatibility	$kp25x_t_compat$	0 or 1	bit	-	1	<p>Can be adjusted by changing the corresponding EEPROM bit:</p> <ul style="list-style-type: none"> 0: vdd_{range} bit is active. Same temperature offset parameter and transfer function for 3.3 V and 5.0 V supply voltage (please see Transfer Function Temperature) 1: vdd_{range} bit is inactive. Different temperature offset parameter and transfer function for 3.3 V and 5.0 V supply voltage (please see Transfer Function Temperature)

(table continues...)

Table 21 (continued) Interface configuration parameters

Configuration parameter	Symbol	Nominal range	Unit	Step width	Default	Note
Acquire pressure and temperature command	$kp25x_{res_compat}$	0 or 1	bit	-	0	Can be adjusted by changing the corresponding EEPROM bit: <ul style="list-style-type: none"> 0: 10-bit acquire pressure/ temperature command like e.g. KP254 1: 12-bit acquire pressure/ temperature command like e.g. KP253

4.2.5 Diagnosis

The sensor is able to detect automatically the following malfunctions:

- Pressure out of range (low and high)
- Signal path check (Diag1)
- Sensor cell check (Diag2)
- EEPROM check (ECC error)

If a malfunction is detected, the responding diagnosis code is sent with the next response.

Note: The Diag1 and Diag2 test can only be triggered by the separate Trigger Diagnosis Command. After this command the user has to wait the time t_{diag_wait} (see in table [SPI timing](#)) to get a valid pressure or temperature value after a new request.

In case a 10-bit Acquire Temperature or Pressure Command is received by the device a 5-bit diagnosis will be transmitted during the next received command as part of the 10-bit Response Structure (see [Chapter 4.2.4.4](#)).

If more than one test fails, only that diagnosis code with the highest priority will be sent.

Table 22 5-bit diagnosis codes

Failure	Priority	Diagnosis Code				
		Bit 15	Bit 14	Bit 13	Bit 12	Bit 11
EEPROM: ECC error	1	1	0	0	0	0
Acquisition chain failure: Diag1	2	0	1	0	0	0
Sensor cell failure: Diag2	3	0	0	1	0	0
Pressure out of range: High	4	0	0	0	1	0
Pressure out of range: Low	5	0	0	0	0	1
No error	-	0	1	0	1	0

In case a 12-bit Acquire Temperature or Pressure Command is received by the device a 3-bit diagnosis will be transmitted during the next received command as part of the 12-bit Response Structure (see [Chapter 4.2.4.4](#)).

If more than one test fails, only that diagnosis code with the highest priority will be sent.

Table 23 3-bit diagnosis codes

Failure	Priority	Diagnosis Code		
		Bit 15	Bit 14	Bit 13
EEPROM: ECC error	1	1	0	0
Acquisition chain failure: Diag1	2	0	1	0
Sensor cell failure: Diag2	3	0	0	1
No error	-	0	1	1

In case a 14-bit Acquire Temperature or Pressure Command is received by the device a 1-bit diagnosis will be transmitted during the next received command as part of the 14-bit Response Structure (see [Chapter 4.2.4.4](#)).

Table 24 1-bit diagnosis codes

Failure	Diagnosis Code
	Bit 15
EEPROM: ECC error	1
No error	0

Note: The diagnosis codes Diag1 and Diag2 are not updated until a self diagnosis is triggered by sending the Trigger Diagnosis Command.

4.2.5.1 Diagnosis reset

The Reset-bit C12 of a SPI command allows using different reset strategies:

- Reset-bit = '0': All transmitted failures will be reset (with the exception of ECC error)
- Reset-bit': A transmitted failure will not be reset

Attention: *Reset of the ECC error is not possible. Once they are detected and transmitted it remains until supply reset or power-down mode is entered.*

4.2.5.1.1 Reset-bit = '1'

Once a failure is detected, the corresponding diagnosis code is still transmitted continuously, even if the failure disappears/is no longer present, as long as:

- A failure with a higher priority is not detected
- The sensor is not reset (power-down)

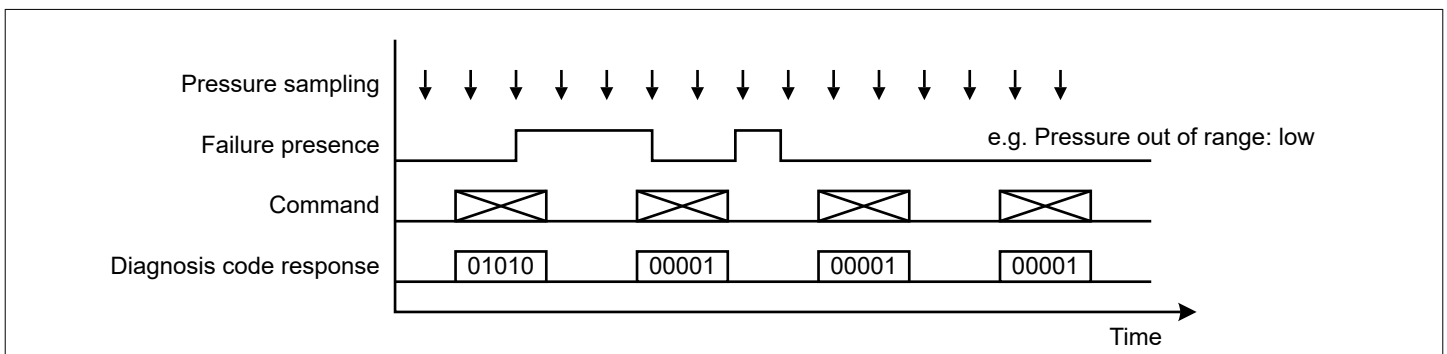

Figure 36 Example for reset strategy Reset-bit C12 = '1'

4.2.5.1.2 Reset-bit = '0'

A detected failure is only transmitted by the responding diagnosis code as long as the failure is present with the exception of ECC error. The diagnosis code will be reset after once transmitted. Only if the failure is detected again, the diagnosis code will be transmitted again with the next response.

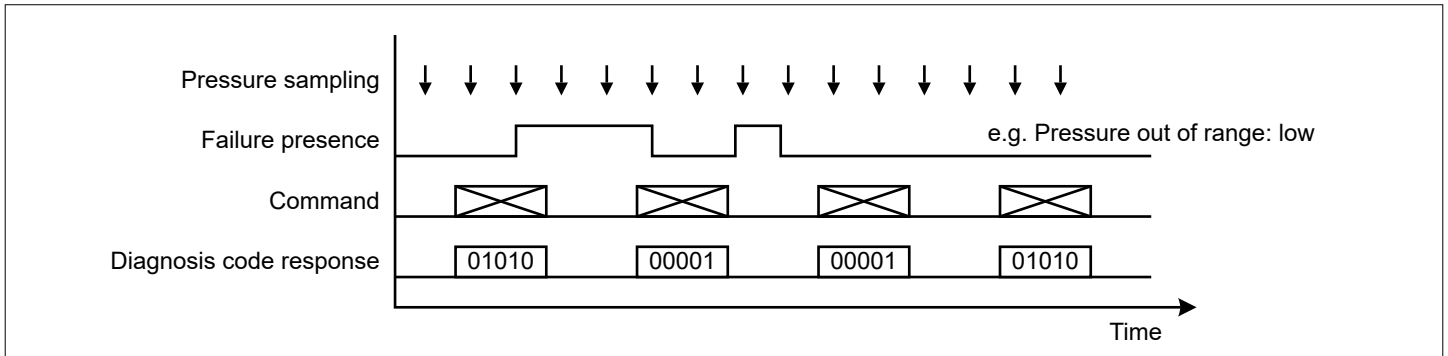

Figure 37 Example for reset strategy Reset-bit C12 = '0'

4.2.5.2 Pressure out of range

The measured pressure is internally checked. If the pressure value falls below the lower limit $p_{IN,1}$ or exceeds the higher limit $p_{IN,2}$ the corresponding diagnosis code will be set. The lower and higher limits are defined in the [Transfer Function Pressure](#) chapter.

4.2.5.3 Diag1

The Diag1 test checks the functionality of the signal path. Therefore the inputs of the sigma delta ADC are shorted. Afterwards, the system response is compared with the expected range (~ 50% of full scale range). If the system response is out of range, the diagnosis code is set.

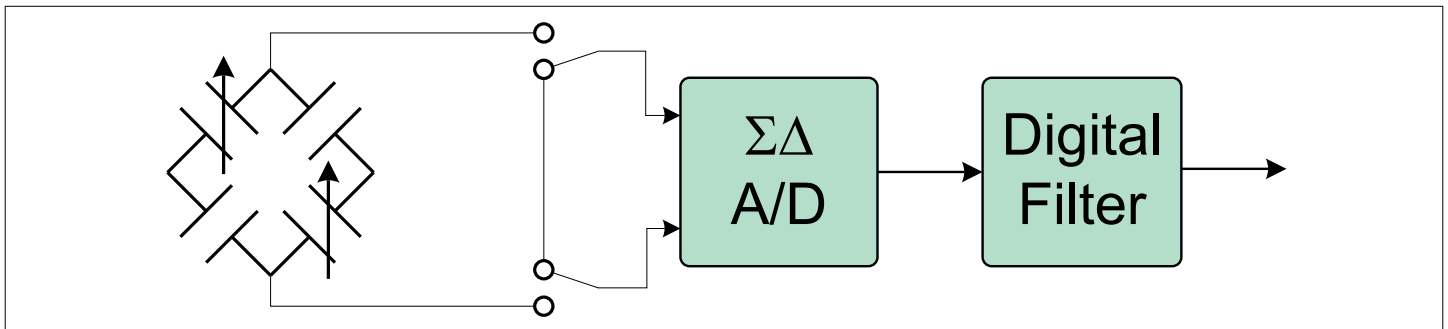

Figure 38 Diag1 functionality

4.2.5.4 Diag2

The Diag2 test checks the functionality of the pressure sensor cells. Therefore a malfunction (e.g. broken membrane) can be detected. The KP46x pressure sensing element is made of 2 measuring cells and 2 reference cells. In the normal mode these four cells are connected in a Wheatstone bridge configuration. In the Diag2 mode, the connection of the cells is modified as shown in the figure below:

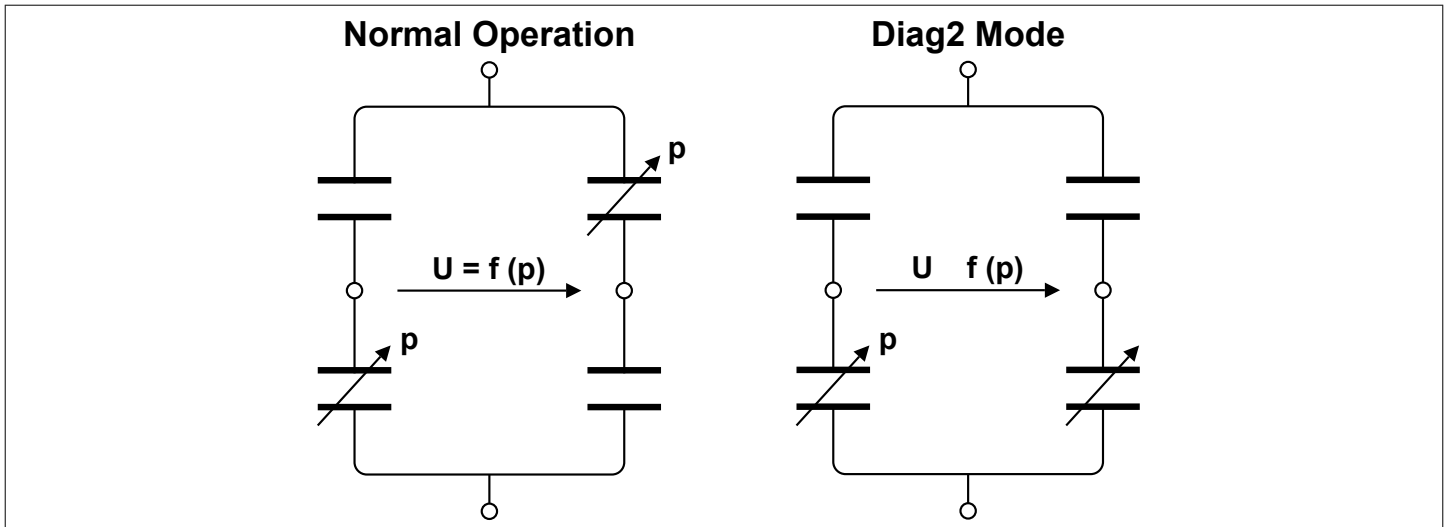

Figure 39 Diag2 functionality

4.2.5.5 EEPROM check

Every start-up and wake-up a full EEPROM ECC test will be executed. Each EEPROM word consist of 16 data bits and 6 ECC bits. The 6 ECC bits allow the detection and correction of one flipped data bit and the detection of two flipped data bits within one EEPROM word (16 data bits).

A one bit error per EEPROM word will be corrected. The sensor will continue with normal operation. Any additional bit error in this EEPROM word results in an ECC error. In case of an ECC error the corresponding diagnosis code will be transmitted with the next response.

4.2.6 Calculation of overall power consumption

The formulas below can be used in order to calculate the overall average power consumption of the device in normal operation mode based on the system and SPI configuration (e.g. C_{load} on SDO):

$$I_{VDD_{average}} [\mu A] = I_{VDD} + I_{SPI_{average}} \quad (3)$$

$$I_{VDD_{average}} [\mu A] = I_{VDD} + \frac{16 \times f_{NCS}}{f_{SPI}} \times \left(250 \mu A + \frac{f_{SPI} \times C_{load} \times V_{DD}}{2} \right) \quad (4)$$

Table 25 Variables of overall average power consumption formula

Variable	Description	Unit
I_{VDD}	Supply current into VDD	μA
f_{NCS}	Sampling rate (e.g. pressure requests)	MHz
f_{SPI}	Clock frequency of SPI interface	MHz
C_{load}	Load capacitance on SDO	pF
V_{DD}	Supply Voltage	V

4.2.7 Start-up behavior

There is no SPI response of the device on any SPI command during the start-up phase ($t_{start-up}$ - see in table [Electrical characteristics](#)).

5 Application information

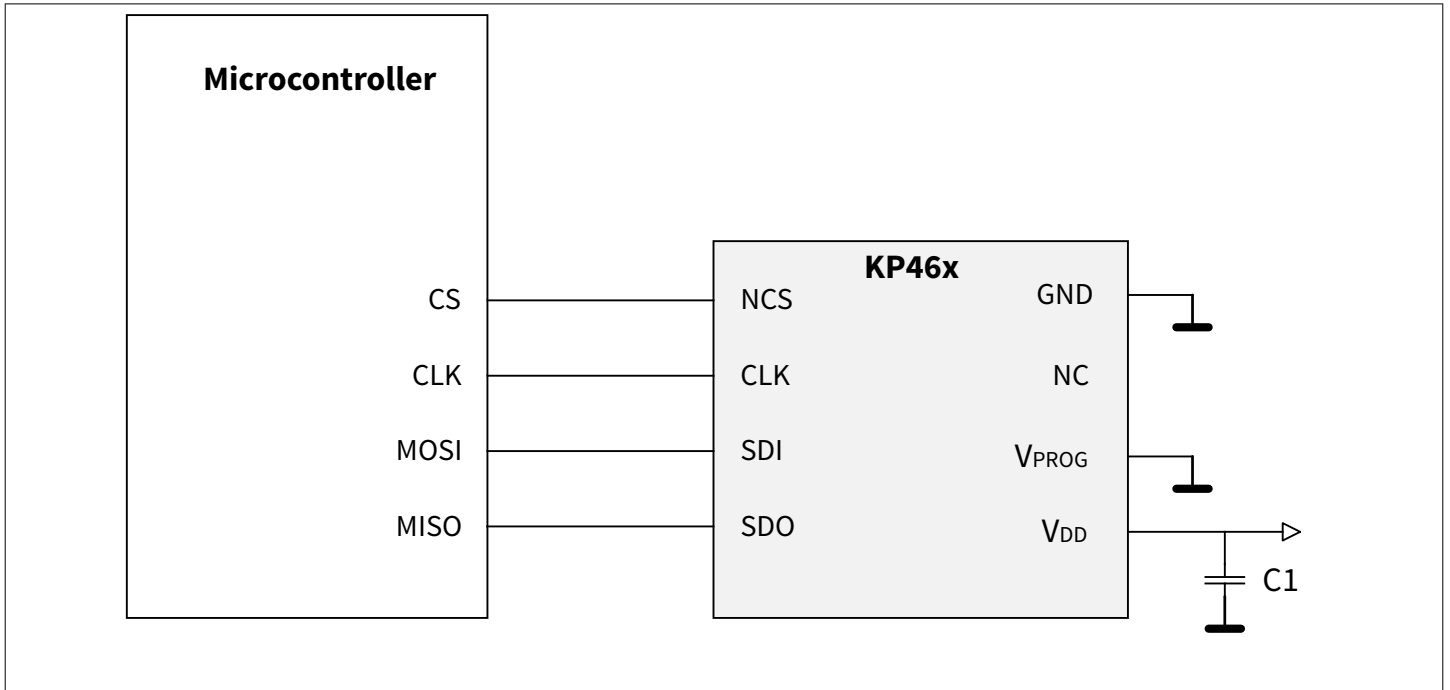

Figure 40 Example application diagram

Table 26 Component Values

Parameter	Symbol	Values			Unit	Note or condition
		Min.	Typ.	Max.		
Supply Decoupling Capacitor	C1	30	100	–	nF	<p>Typ: The use of a blocking capacitor with at least a nominal value of 100nF is mandatory; any drift or tolerances in capacity of standard capacitors are already considered. To avoid any measurement inaccuracy the supply blocking capacitor has to be placed as close as possible to the VDD pin, at least the distance must be less than 10mm.</p> <p>Min: The minimum capacity C1 including any variations or drift over lifetime must not undershoot the minimum C1 value.</p>

6 Package

The package is a PG-DFN-8-1 as shown below:

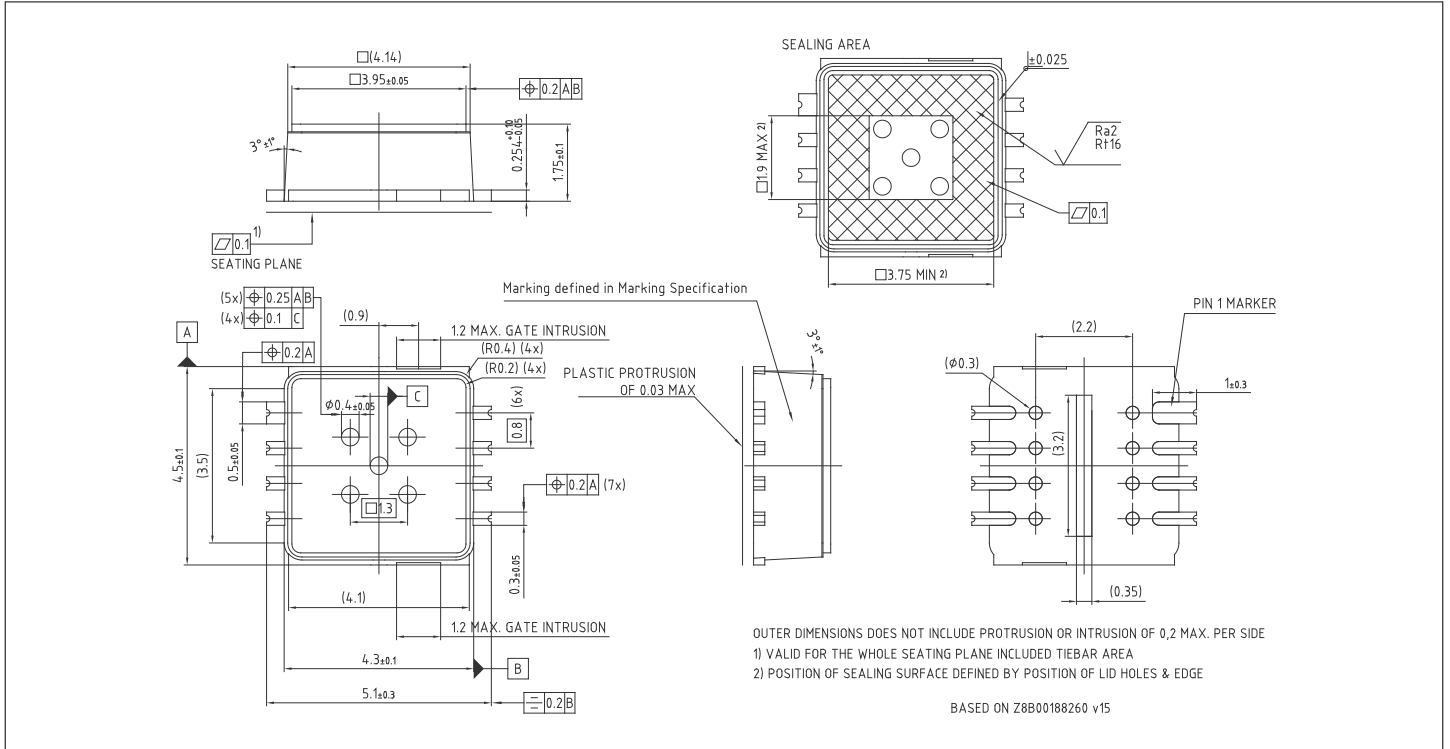

Figure 41 PG-DFN-8-1 outlines

Green Product (RoHS compliant)

To meet the world-wide customer requirements for environmentally friendly products and to be compliant with government regulations the device is available as a green product. Green products are RoHS-Compliant (i.e Pb-free finish on leads and suitable for Pb-free soldering according to IPC/JEDEC J-STD-020).

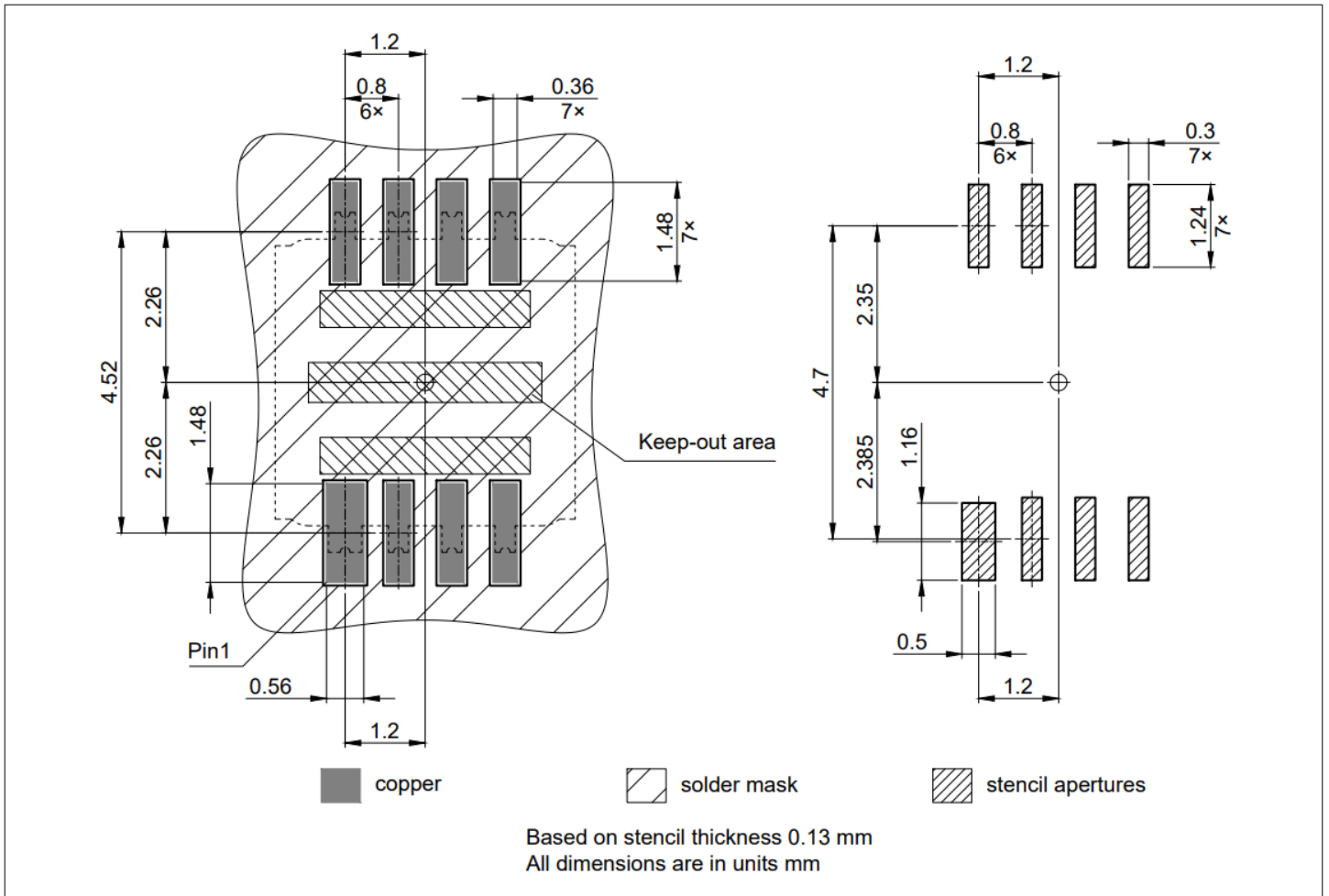

Figure 42 Package footprint drawing

Although the self-alignment effect due to the surface tension of the liquid solder will support the formation of reliable solder joints, the components have to be placed accurately according to their geometry. Manual positioning of the package is not recommended, but it is possible. For the PG-DFN package with a pad width of 0.3 mm and a pitch of 0.8 mm, an automatic pick-and-place machine is recommended to achieve reliable solder joints. The device is delivered in tape and reel packing which is suitable for being used in pick-and-place equipment.

6.1 Identification code

The identification code for the device is on the same side of the package as pin 1.

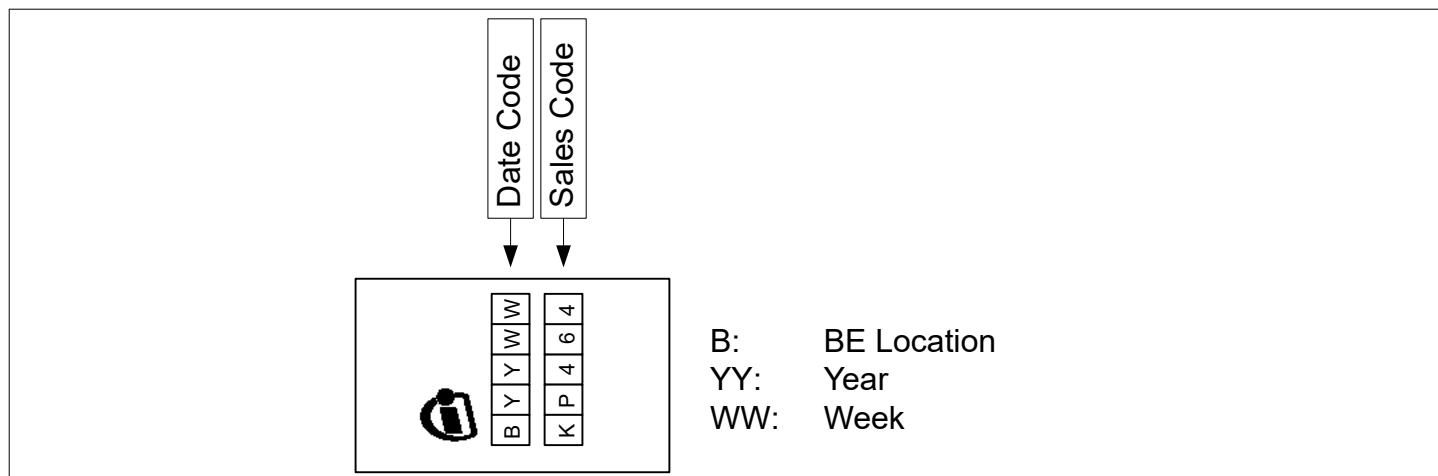

Figure 43 Identification code

7 Revision history

Table 27 **Revision history**

Revision number	Date of release	Description of changes
1.0	2022-11-25	Initial release

Trademarks

All referenced product or service names and trademarks are the property of their respective owners.

Edition 2022-11-25

Published by

Infineon Technologies AG

81726 Munich, Germany

© 2022 Infineon Technologies AG

All Rights Reserved.

Do you have a question about any aspect of this document?

Email: erratum@infineon.com

Document reference

IFX-gel1669120542280

Important notice

The information given in this document shall in no event be regarded as a guarantee of conditions or characteristics ("Beschaffheitsgarantie").

With respect to any examples, hints or any typical values stated herein and/or any information regarding the application of the product, Infineon Technologies hereby disclaims any and all warranties and liabilities of any kind, including without limitation warranties of non-infringement of intellectual property rights of any third party.

In addition, any information given in this document is subject to customer's compliance with its obligations stated in this document and any applicable legal requirements, norms and standards concerning customer's products and any use of the product of Infineon Technologies in customer's applications.

The data contained in this document is exclusively intended for technically trained staff. It is the responsibility of customer's technical departments to evaluate the suitability of the product for the intended application and the completeness of the product information given in this document with respect to such application.

Warnings

Due to technical requirements products may contain dangerous substances. For information on the types in question please contact your nearest Infineon Technologies office.

Except as otherwise explicitly approved by Infineon Technologies in a written document signed by authorized representatives of Infineon Technologies, Infineon Technologies' products may not be used in any applications where a failure of the product or any consequences of the use thereof can reasonably be expected to result in personal injury.