

OSRAM LE B P1MS

Datasheet

Preliminary datasheet version

Published by ams-OSRAM AG

Tobelbader Strasse 30, 8141 Premstaetten, Austria

Phone +43 3136 500-0

ams-osram.com

© All rights reserved



OSRAM OSTAR® Projection Power

LE B P1MS

OSRAM OSTAR Projection Power is a high luminance LED for projection applications.

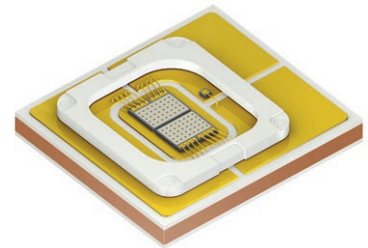

Applications

- Projection & Display

Features

- Package: OSTAR High Power Projection
- Chip technology: UX:3
- Typ. Radiation: 120° (Lambertian emitter)
- Color: $\lambda_{\text{dom}} = 456 \text{ nm}$ (• blue)
- ESD: 2 kV acc. to ANSI/ESDA/JEDEC JS-001 (HBM, Class 2)

Ordering Information

Type	Total radiant flux ¹⁾ $I_F = 4000 \text{ mA}$ Φ_e	Ordering Code
LE B P1MS-EQET-23	7630 ... 10420 mW	Q65113A4266

Maximum Ratings

Parameter	Symbol		Values
Storage Temperature	T_{stg}	min. max.	-40 °C 100 °C
Junction Temperature	T_j	max.	150 °C
Forward Current $T_j = T_{j,max}$	I_F	min. max.	200 mA 6700 mA
Forward Current pulsed $D = 0.7; f = 240 \text{ Hz}; T_j = T_{j,max}$	$I_{F \text{ pulse}}$		8000 mA
Surge Current $t_p \leq 50 \mu\text{s}; D = 0.1; T_j = T_{j,max}$	I_{FS}	max.	9500 mA
ESD withstand voltage acc. to ANSI/ESDA/JEDEC JS-001 (HBM, Class 2)	V_{ESD}		2 kV
Reverse current ²⁾	I_R	max.	200 mA
Max. voltage difference anode-board, cathode-board	$ \Delta V_{a-b} , \Delta V_{c-b} $	max.	40 V

Characteristics

$T_{\text{Board}} = 25\text{ °C}$; $I_{\text{F}} = 4000\text{ mA}$; $f = 1000\text{ Hz}$; $D = 0.25$

Parameter	Symbol	Values	Values
Peak Wavelength	λ_{peak}	typ.	450 nm
Dominant Wavelength ³⁾	λ_{dom}	min.	452 nm
		typ.	456 nm
		max.	460 nm
Spectral bandwidth at 50% $I_{\text{rel,max}}$	$\Delta\lambda$	typ.	23 nm
Viewing angle at 50% I_{V}	2ϕ	typ.	120 °
Radiating surface	A_{color}	typ.	1.95 x 1.35 mm ²
Partial Flux acc. CIE 127:2007 ⁴⁾ $I_{\text{F}} = 4000\text{ mA}$	$\Phi_{\text{E/V, 120°}}$	typ.	0.77
Forward Voltage ⁵⁾ $I_{\text{F}} = 4000\text{ mA}$	V_{F}	min.	6.4 V
		typ.	6.8 V
		max.	7.6 V
Reverse voltage (ESD device)	V_{RESD}	min.	45 V
Reverse voltage ²⁾ $I_{\text{R}} = 20\text{ mA}$	V_{R}	max.	1.2 V
Real thermal resistance junction/solderpoint	$R_{\text{thJS real}}$	typ.	1.30 K / W
Electrical thermal resistance junction/solderpoint with efficiency $\eta_{\text{e}} = 31\%$	$R_{\text{thJS elec.}}$	typ.	1.0 K / W

Brightness Groups

Group	Total radiant flux ¹⁾ $I_F = 4000 \text{ mA}$ min. Φ_e	Total radiant flux ¹⁾ $I_F = 4000 \text{ mA}$ max. Φ_e
	EQ	7630 mW
ER	8200 mW	8920 mW
ES	8920 mW	9700 mW
ET	9700 mW	10420 mW

Wavelength Groups

Group	Dominant Wavelength ³⁾ min. λ_{dom}	Dominant Wavelength ³⁾ max. λ_{dom}
	2	452 nm
3	456 nm	460 nm

Group Name on Label

Example: EQ-2

Brightness	Wavelength
EQ	2

Relative Spectral Emission ⁴⁾

$E_{rel} = f(\lambda); I_F = 4000 \text{ mA}; T_J = 25 \text{ }^\circ\text{C}$

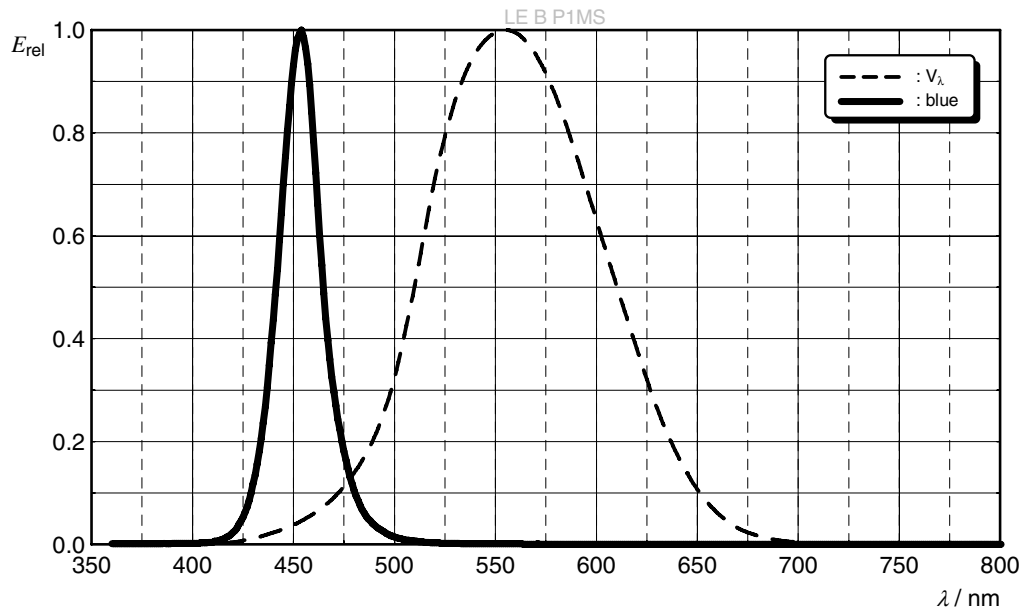

Radiation Characteristics ⁴⁾

$I_{rel} = f(\phi); T_J = 25 \text{ }^\circ\text{C}$

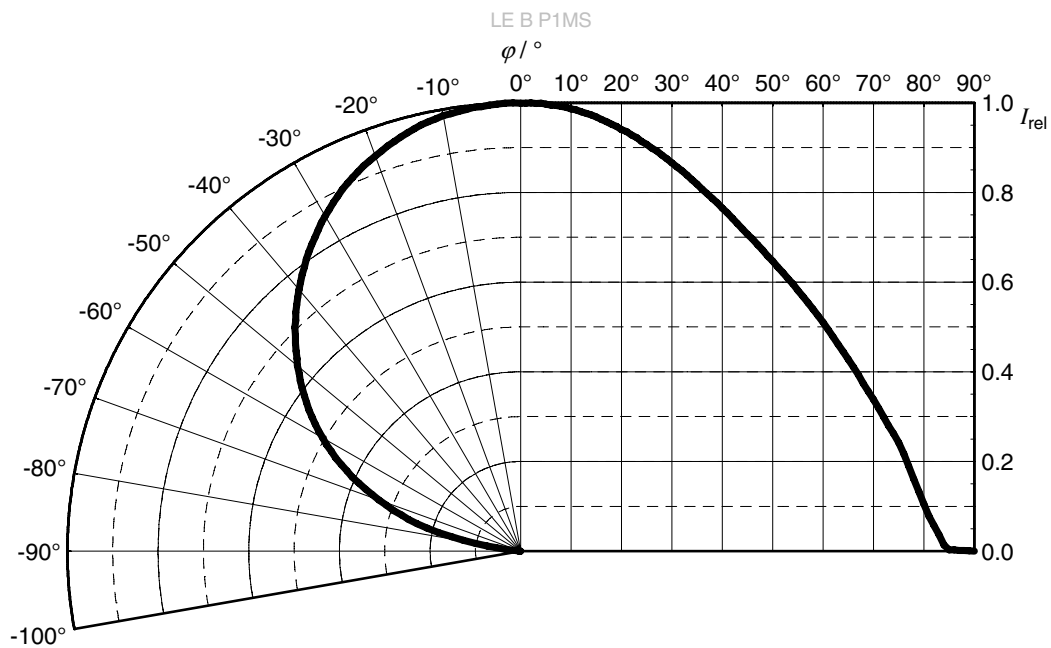

Relative Partial Flux ⁴⁾

$$\Phi_E(2\varphi)/\Phi_E(180^\circ) = f(\varphi); T_j = 25^\circ\text{C}$$

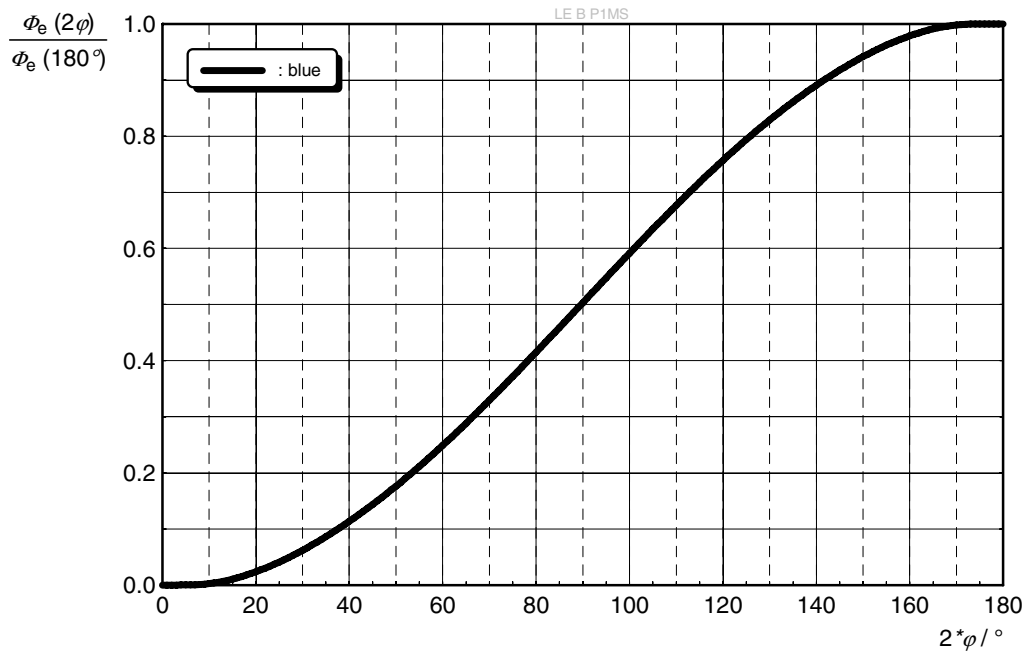

Forward current ⁴⁾

$$I_F = f(V_F); T_J = 25\text{ °C}$$

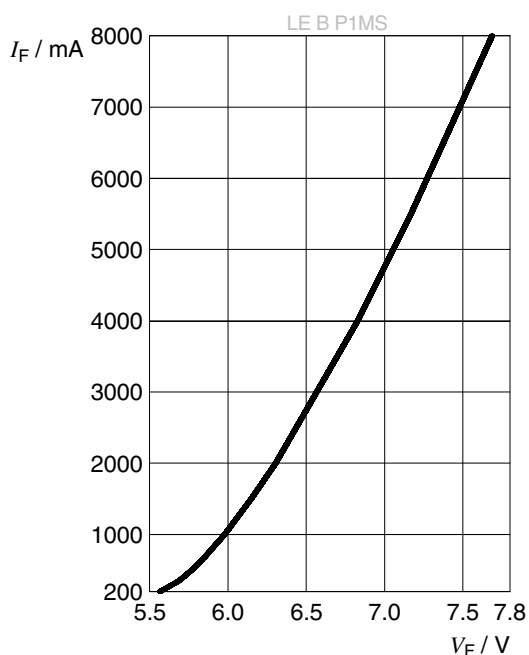

Relative Radiant Power ^{4), 6)}

$$\Phi_E / \Phi_E(4000\text{ mA}) = f(I_F); T_J = 25\text{ °C}$$

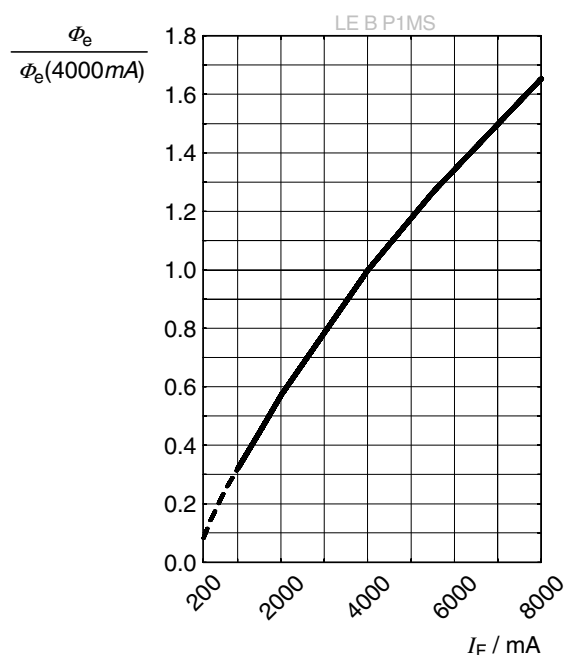

Dominant Wavelength ⁴⁾

$$\Delta\lambda_{\text{dom}} = f(I_F); T_J = 25\text{ °C}$$

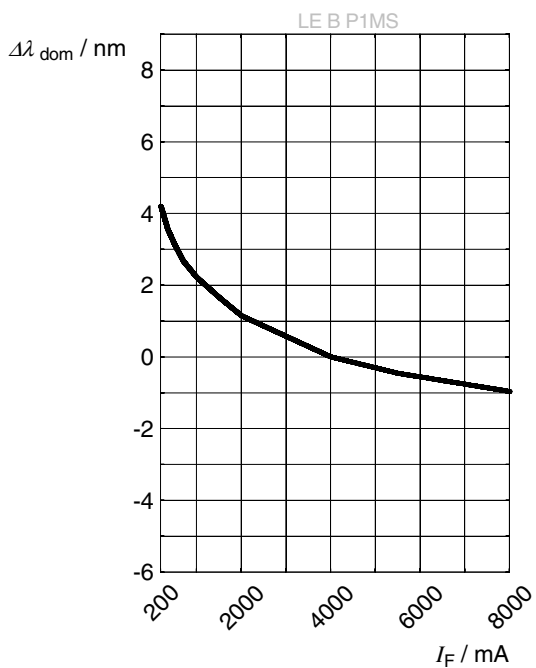

Forward Voltage ⁴⁾

$$\Delta V_F = V_F - V_F(25\text{ °C}) = f(T_j); I_F = 4000\text{ mA}$$

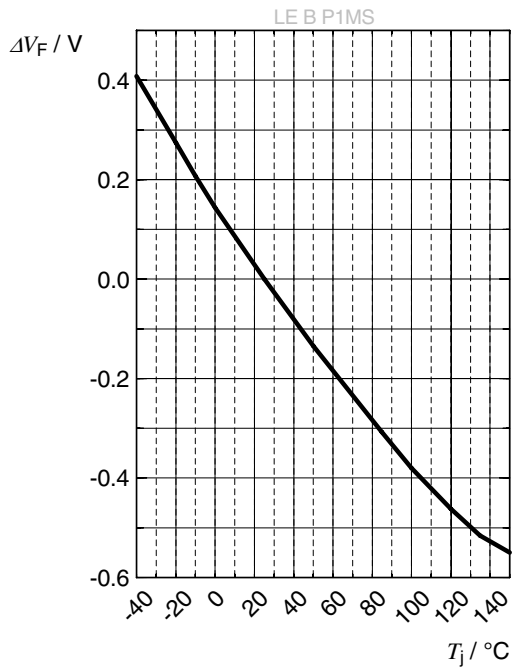

Relative Radiant Power ⁴⁾

$$\Phi_E / \Phi_E(25\text{ °C}) = f(T_j); I_F = 4000\text{ mA}$$

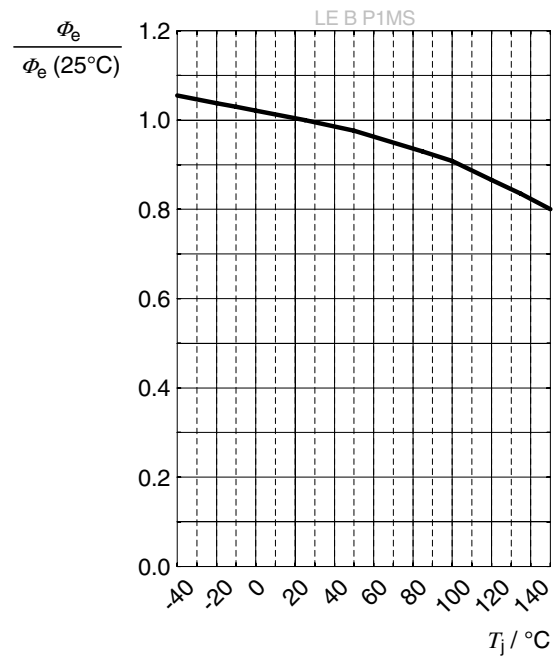

Dominant Wavelength ⁴⁾

$$\Delta \lambda_{\text{dom}} = \lambda_{\text{dom}} - \lambda_{\text{dom}}(25\text{ °C}) = f(T_j); I_F = 4000\text{ mA}$$

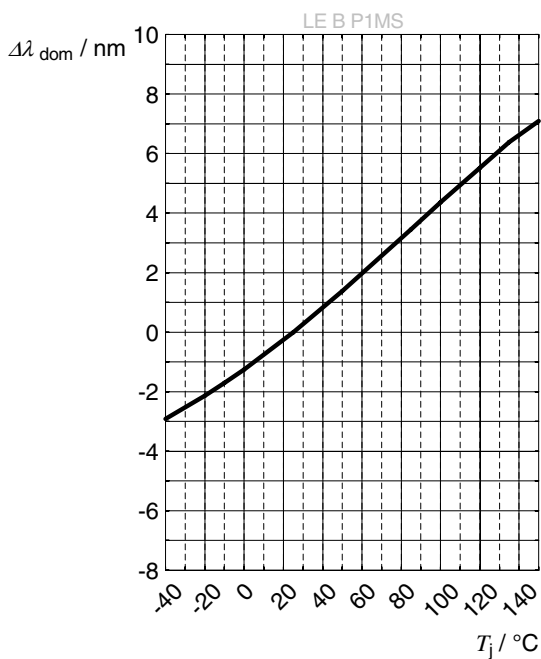

Dimensional Drawing ⁷⁾

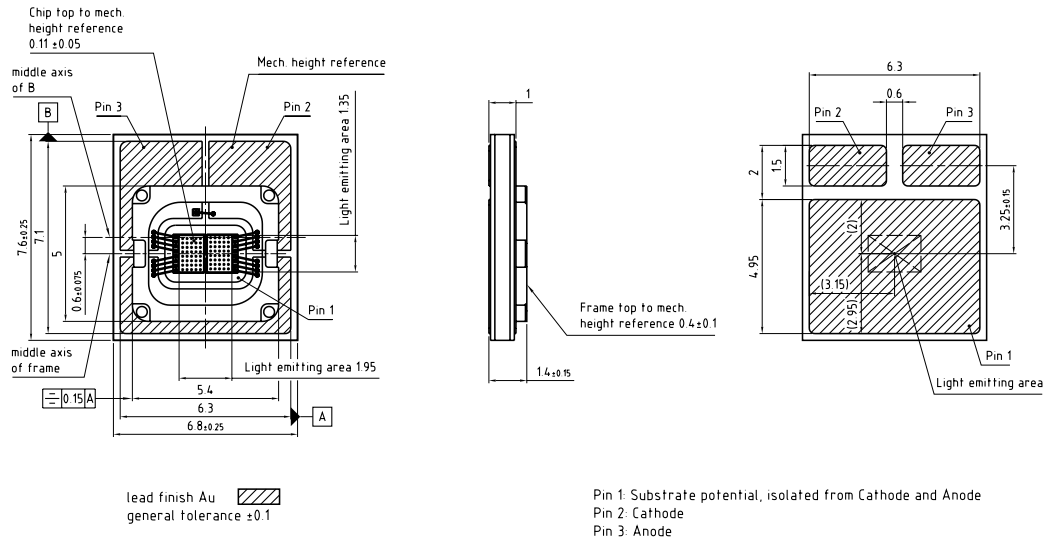

C63062-A4436-A2-03

Further Information:

Approximate Weight: 380.0 mg

ESD advice: The device is protected by ESD device which is connected in parallel to the Chip.

Notes: Package not suitable for any kind of wet cleaning or ultrasonic cleaning.

Electrical Internal Circuit

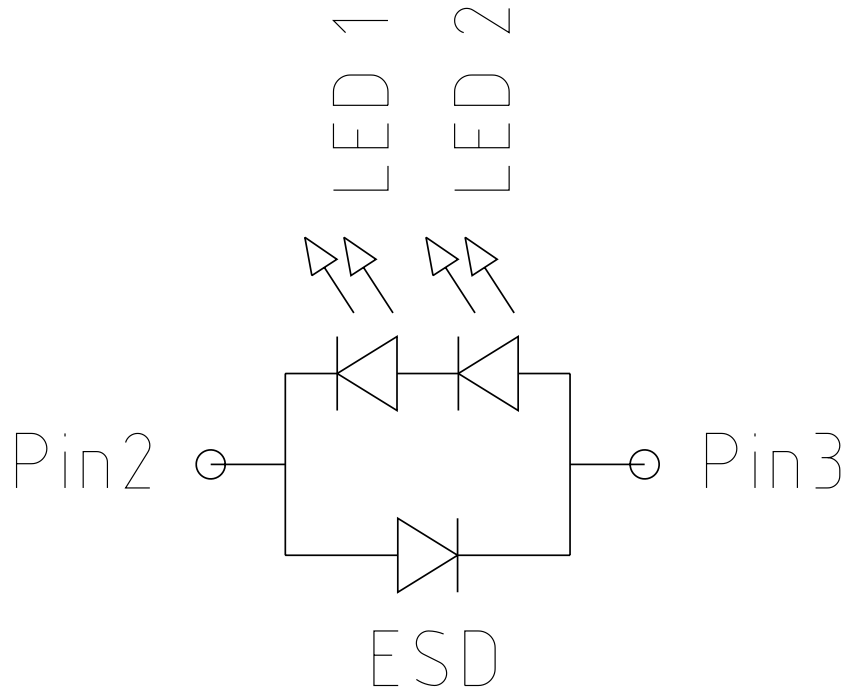

Recommended Solder Pad ⁷⁾

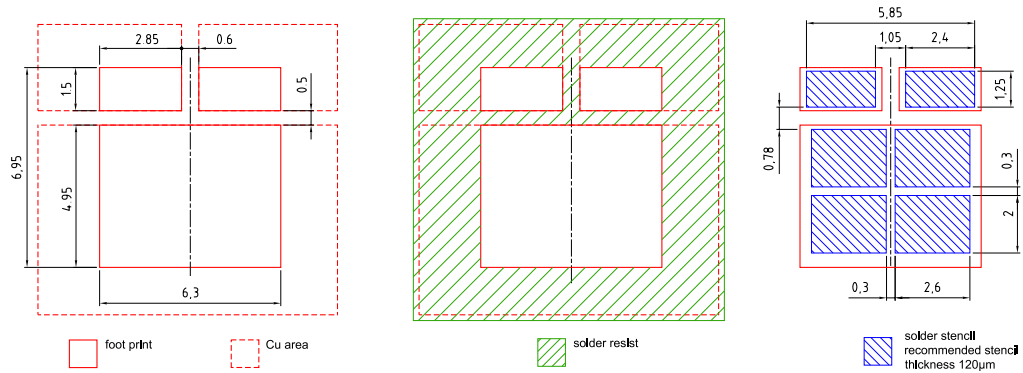

Component Location on Pad

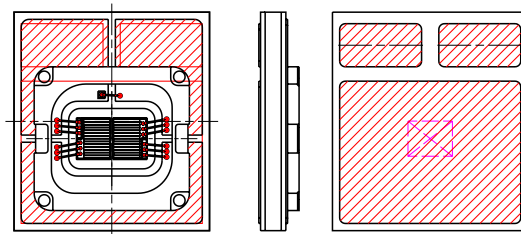

E062.3010.313-01

For protection during reflow soldering and handling a foil is attached to the device. The foil has to be removed before operation. For superior solder joint connectivity results we recommend soldering under standard nitrogen atmosphere. To ensure a high solder joint reliability and to minimize the risk of solder joint cracks, the customer is responsible to evaluate the combination of PCB board and solder paste material for his application.

Reflow Soldering Profile

Product complies to MSL Level 2 acc. to JEDEC J-STD-020E

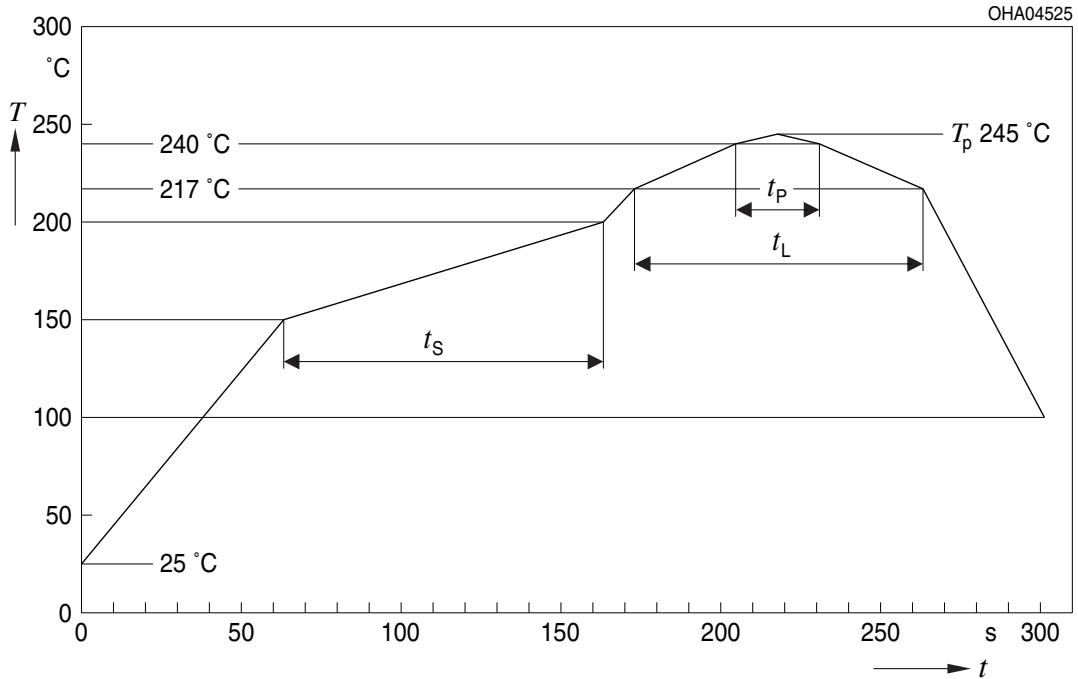

Profile Feature	Symbol	Pb-Free (SnAgCu) Assembly			Unit
		Minimum	Recommendation	Maximum	
Ramp-up rate to preheat ^{*)} 25 °C to 150 °C			2	3	K/s
Time t_s T_{Smin} to T_{Smax}	t_s	60	100	120	s
Ramp-up rate to peak ^{*)} T_{Smax} to T_p			2	3	K/s
Liquidus temperature	T_L		217		°C
Time above liquidus temperature	t_L		80	100	s
Peak temperature	T_p		245	260	°C
Time within 5 °C of the specified peak temperature $T_p - 5$ K	t_p	10	20	30	s
Ramp-down rate* T_p to 100 °C			3	6	K/s
Time 25 °C to T_p				480	s

All temperatures refer to the center of the package, measured on the top of the component
^{*} slope calculation DT/Dt : Dt max. 5 s; fulfillment for the whole T-range

Taping ⁷⁾

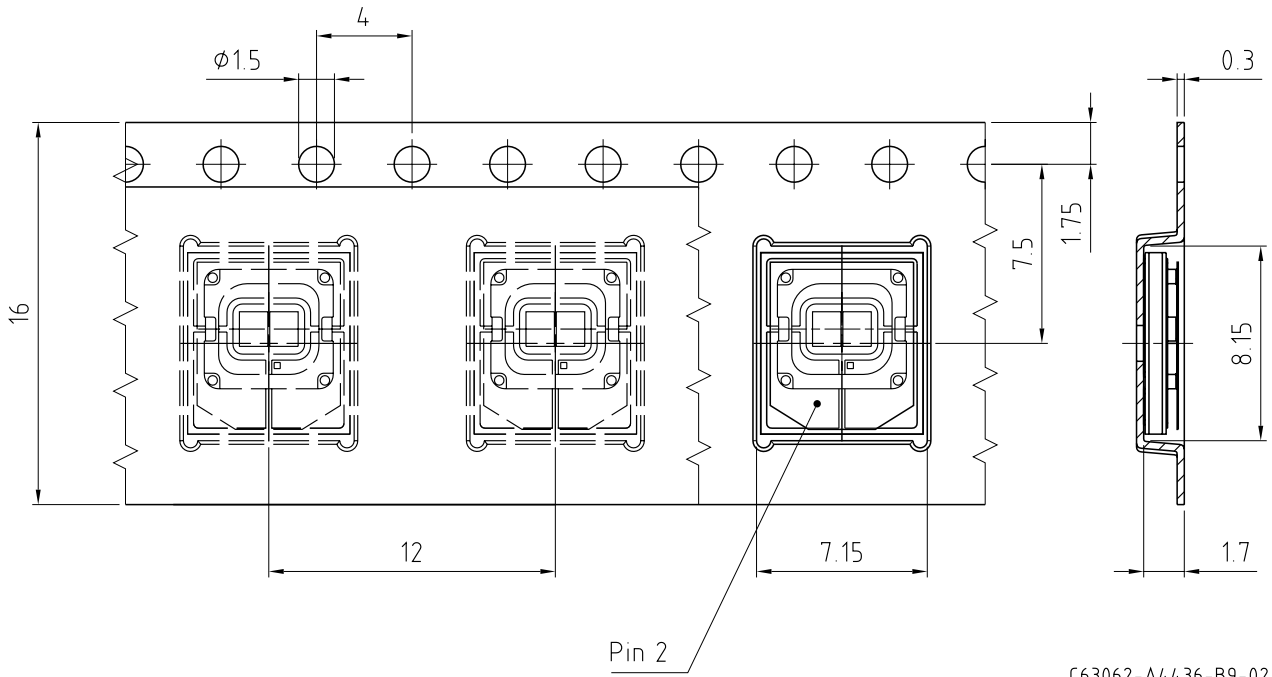

C63062-A4436-B9-02

Tape and Reel ⁸⁾

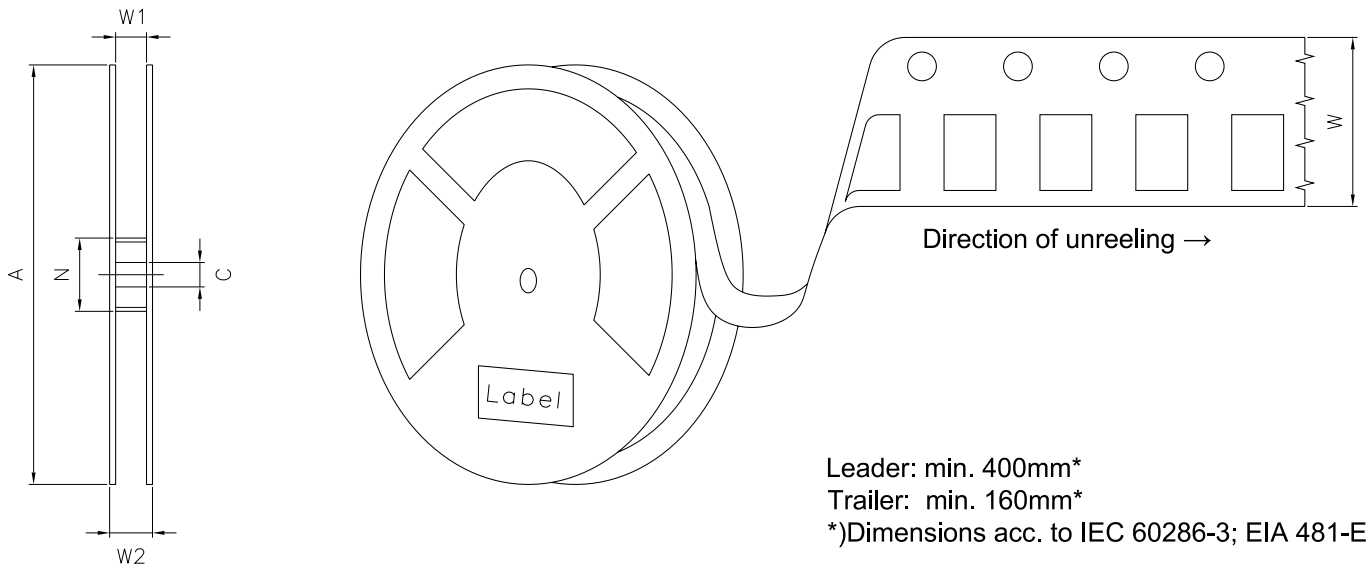

Reel Dimensions

A	W	N _{min}	W ₁	W _{2 max}	Pieces per PU
180 mm	16 + 0.3 / - 0.1 mm	60/100 mm	16.4 + 2 mm	22.4 mm	500

Barcode-Product-Label (BPL)

OSRAM Opto Semiconductors LX XXXX BIN1: XX-XX-X-XXX-X

RoHS Compliant





(6P) BATCH NO: 1234567890

(1T) LOT NO: 1234567890 (9D) D/C: 1234

(X) PROD NO: 123456789 (Q) QTY: 9999 (G) GROUP: XX-XX-X-X

ML Temp ST
X XXX °C X

Pack: RXX
DEMY XXX
X_X123_1234.1234 X



OHA04563

Notes

The evaluation of eye safety occurs according to the standard IEC 62471:2006 (photo biological safety of lamps and lamp systems). Within the risk grouping system of this IEC standard, the device specified in this data sheet fall into the class **moderate risk (exposure time 0.25 s)**. Under real circumstances (for exposure time, conditions of the eye pupils, observation distance), it is assumed that no endangerment to the eye exists from these devices. As a matter of principle, however, it should be mentioned that intense light sources have a high secondary exposure potential due to their blinding effect. When looking at bright light sources (e.g. headlights), temporary reduction in visual acuity and afterimages can occur, leading to irritation, annoyance, visual impairment, and even accidents, depending on the situation.

Subcomponents of this device contain, in addition to other substances, metal filled materials including silver. Metal filled materials can be affected by environments that contain traces of aggressive substances. Therefore, we recommend that customers minimize device exposure to aggressive substances during storage, production, and use. Devices that showed visible discoloration when tested using the described tests above did show no performance deviations within failure limits during the stated test duration. Respective failure limits are described in the IEC60810.

For further application related information please visit www.osram-os.com/appnotes

Disclaimer

AMS OSRAM assumes no liability whatsoever for any use of this document or its content by recipient including, but not limited to, for any design in activities based on this preliminary draft version. AMS OSRAM may e.g. decide at its sole discretion to stop developing and/or finalizing the underlying design at any time.

Attention please!

The information describes the type of component and shall not be considered as assured characteristics. Terms of delivery and rights to change design reserved. Due to technical requirements components may contain dangerous substances.

For information on the types in question please contact our Sales Organization.

If printed or downloaded, please find the latest version on our website.

Packing

Please use the recycling operators known to you. We can also help you – get in touch with your nearest sales office. By agreement we will take packing material back, if it is sorted. You must bear the costs of transport. For packing material that is returned to us unsorted or which we are not obliged to accept, we shall have to invoice you for any costs incurred.

Product and functional safety devices/applications or medical devices/applications

Our components are not developed, constructed or tested for the application as safety relevant component or for the application in medical devices.

Our products are not qualified at module and system level for such application.

In case buyer – or customer supplied by buyer – considers using our components in product safety devices/ applications or medical devices/applications, buyer and/or customer has to inform our local sales partner immediately and we and buyer and /or customer will analyze and coordinate the customer-specific request between us and buyer and/or customer.

Glossary

- 1) **Brightness:** Brightness values are measured during a pulse train of 100 ms with a pulse width of 250 μ s and a frequency of 1 kHz, with an internal reproducibility of \pm 8 % and an expanded uncertainty of \pm 11 % (acc. to GUM with a coverage factor of $k = 3$). The peak brightness is calculated according to the pulse duration and frequency.
- 2) **Reverse Operation:** This product is intended to be operated applying a forward current within the specified range. Applying any continuous reverse bias or forward bias below the voltage range of light emission shall be avoided because it may cause migration which can change the electro-optical characteristics or damage the LED.
- 3) **Wavelength:** The wavelength is measured during a pulse train of 100 ms with a pulse width of 250 μ s and a frequency of 1 kHz, with an internal reproducibility of \pm 0,5 nm and an expanded uncertainty of \pm 1 nm (acc. to GUM with a coverage factor of $k=3$).
- 4) **Typical Values:** Due to the special conditions of the manufacturing processes of semiconductor devices, the typical data or calculated correlations of technical parameters can only reflect statistical figures. These do not necessarily correspond to the actual parameters of each single product, which could differ from the typical data and calculated correlations or the typical characteristic line. If requested, e.g. because of technical improvements, these typ. data will be changed without any further notice.
- 5) **Forward Voltage:** The forward voltage is measured during a pulse of typical 250 μ s, with an internal reproducibility of \pm 0,05 V and an expanded uncertainty of \pm 0,1 V (acc. to GUM with a coverage factor of $k=3$).
- 6) **Characteristic curve:** In the range where the line of the graph is broken, you must expect higher differences between single devices within one packing unit.
- 7) **Tolerance of Measure:** Unless otherwise noted in drawing, tolerances are specified with \pm 0.1 and dimensions are specified in mm.
- 8) **Tape and Reel:** All dimensions and tolerances are specified acc. IEC 60286-3 and specified in mm.

Revision History

Version	Date	Change
0.0	2022-08-01	Initial Version
0.1	2022-09-26	Characteristics

Preliminary datasheet version



EU RoHS and China RoHS compliant product

此产品符合欧盟 RoHS 指令的要求；
按照中国的相关法规和标准，
不含有毒有害物质或元素。

Published by ams-OSRAM AG

Tobelbader Strasse 30, 8141 Premstaetten, Austria

Phone +43 3136 500-0

ams-osram.com

© All rights reserved

am 

OSRAM