

Seeeduino Mega

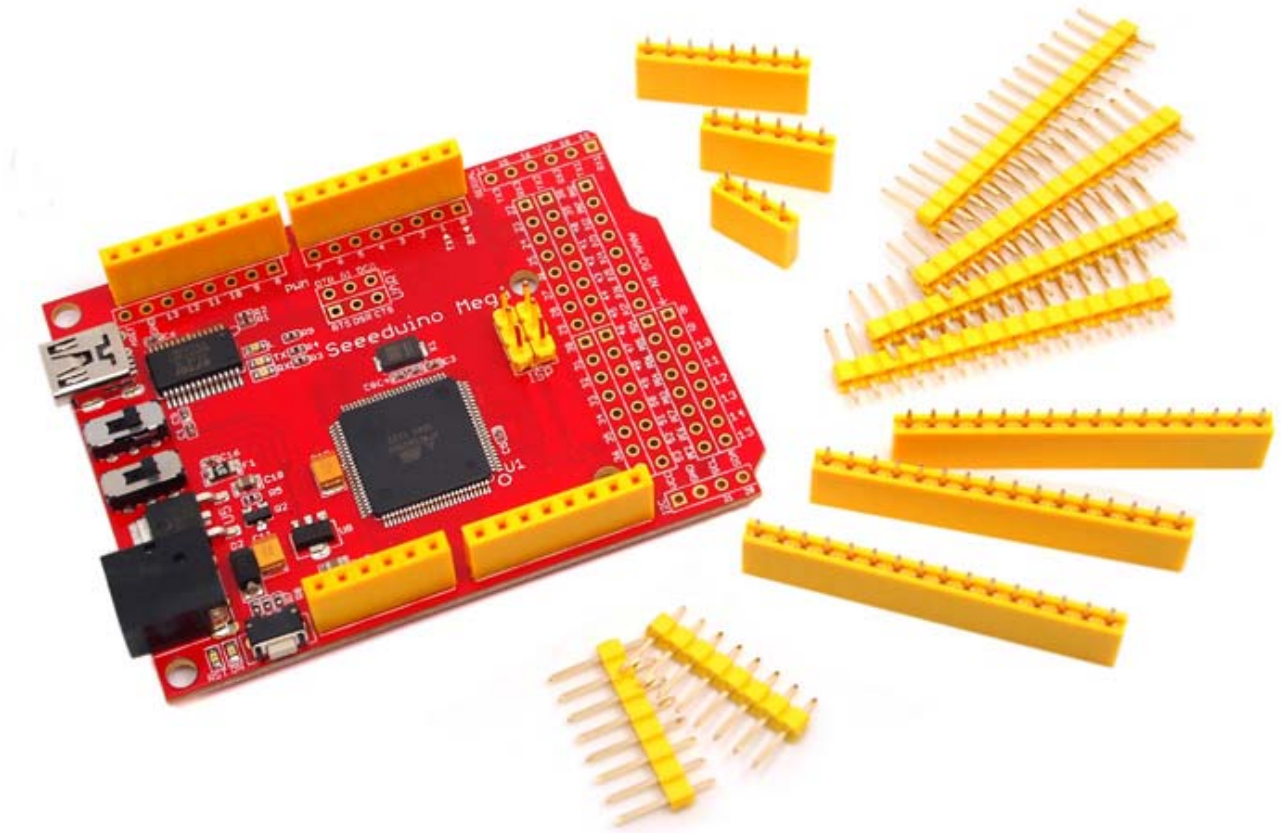

Seeeduino Mega is a powerful micro-controller derived from Arduino Mega. It features ATmega2560 processor which brings a large number of I/O pins, as much as 70 digital I/O, 16 analog inputs, 14 PWM, and 4 hardware serial ports. Compared to Arduino Mega, we shrunk the volume of Arduino Mega by at least 30% and made it 100% compatible with [Seeed Shield products](#). And as a member of Seeeduino series, Seeeduino Mega inherits deliberate details from Seeeduino, like selectable operating voltage(3.3V/5V), right angle reset button, and so on.

Application Ideas

- Internet of Things
- DIY
- Robot
- Smart House
- 3D Printer
- Industrial

Here are some funny projects for your reference.

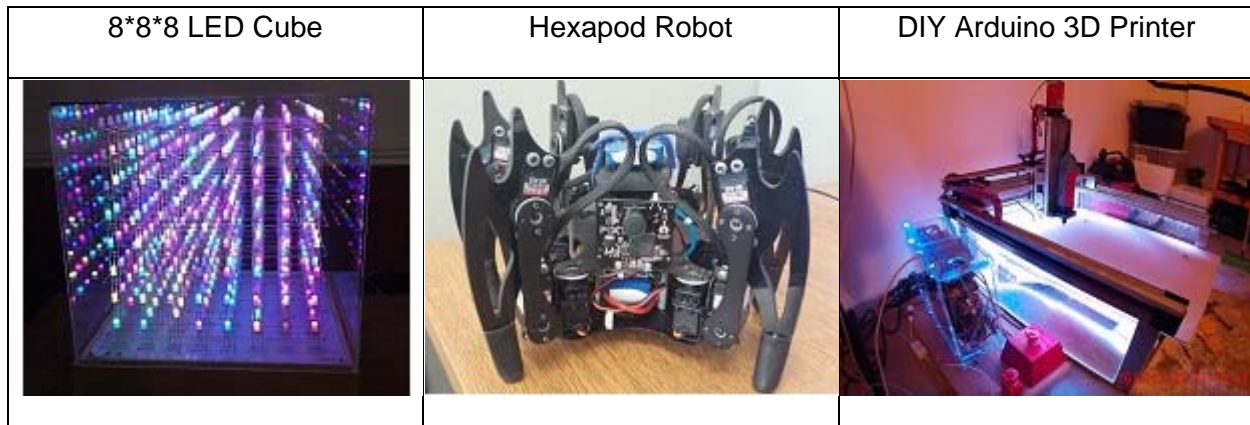

Features

- Compatible with most Arduino Duemilanove and Diecimila Shields
- ATmega 2560 @ 16MHz
- Selectable 5V/3.3V operation
- 70 Digital IO
- 16 Analog inputs
- 14 PWM outputs
- 4 Hardware serial ports (UART)
- Small form factor, 30% smaller than Arduino Mega
- Easy to program, no additional hardware is required to load firmware – just plug to a USB port and you're good to go.
- ICSP Header
- Can be powered through a battery or through a AC to DC adaptor

Specification

Item	Value
Microcontroller	ATmega2560
Operating Voltage	5V/3.3V
Input Voltage	7-12V
Digital I/O Pins	70
PWM Channels	14
Analog Input Channels	16
DC Current per I/O Pin	20 mA
Flash Memory	256 KB

Item	Value
RAM	8 KB
EEPROM	4 KB
Clock Speed	16 MHz

Hardware Overview

The image below shows an overview of Seeeduino Mega hardware features. The pin-out and alternate functions of various pins of Seeeduino Mega are shown in the pin-out diagram. This could be used as a quick reference.

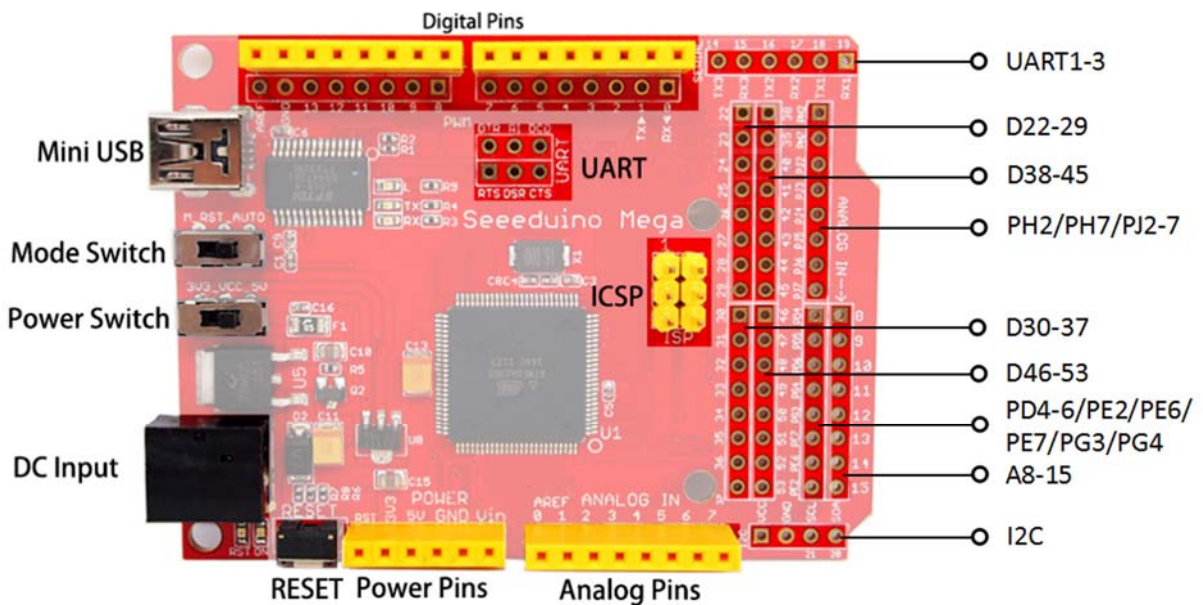

- **Mini USB** Mini USB Port is used to connect the board to your PC for programming and for powering up.
- **Mode Switch** Slide switch used to allow or avoid automatic reset and upload.
- **Power Switch** Slide switch used to change the logic level and power output of the board to either 5V or 3.3V. Nowadays many new and great sensors are being develop to work with 3.3V, with other duino boards you would need to place a logic level converter between the board and these sensor(s), with the Seeeduino Mega all you have to do is slide the switch!
- **DC Input** The DC Input allows your Seeeduino Mega to be powered from a wall adapter so that you can supply more power to your project if needed, for example when using DC motors or other high power devices. The DC input can be 7V-12V. As peak current is 2A when model is power on, DC Power is your better choice then USB power.
- **Reset** This button is conveniently placed on the side to allow you to reset the Seeeduino board even when a shield is placed on top. This is not the case in other Arduino boards where the button is placed on top making it hard to access.
- **ICSP** This is the ICSP connection for the ATmega328P, it is located in the standard ICSP/SPI position for Arduino Uno, Due, Mega, and Leonardo compatible hardware (e.g. shields) that may use this connector. The SPI pins in this port: MISO, SCK, and MOSI, are also connected to digital pins 12, 13, and 11 respectively just like those of the Arduino Uno.
- **Digital Pins** There are up to 70 digital pins in Seeeduino Mega. Click [here](#) to see the pin mapping between Arduino Pins and Atmega2560 pins. Each of the 70 digital pins on the Mega can be used as an input or output, using pinMode(), digitalWrite(), and digitalRead() functions. They operate at 5 volts. Each pin can provide or receive 20 mA as recommended operating condition and has an internal pull-up resistor (disconnected by default) of 20-50 k ohm. A maximum of 40mA is the value that must not be exceeded to avoid permanent damage to the microcontroller. In addition, some pins have specialized functions:
 - Serial: 0 (RX) and 1 (TX); Serial 1: 19 (RX) and 18 (TX); Serial 2: 17 (RX) and 16 (TX); Serial 3: 15 (RX) and 14 (TX). Used to receive (RX) and transmit (TX) TTL serial data. Pins 0 and 1 are also connected to the corresponding pins of the ATmega16U2 USB-to-TTL Serial chip.

- External Interrupts: 2 (interrupt 0), 3 (interrupt 1), 18 (interrupt 5), 19 (interrupt 4), 20 (interrupt 3), and 21 (interrupt 2). These pins can be configured to trigger an interrupt on a low level, a rising or falling edge, or a change in level. See the `attachInterrupt()` function for details.
- PWM: 2 to 13 and 44 to 46. Provide 8-bit PWM output with the `analogWrite()` function.
- SPI: 50 (MISO), 51 (MOSI), 52 (SCK), 53 (SS). These pins support SPI communication using the SPI library. The SPI pins are also broken out on the ICSP header, which is physically compatible with the Arduino /Genuino Uno.
- LED: 13. There is a built-in LED connected to digital pin 13. When the pin is HIGH value, the LED is on, when the pin is LOW, it's off.
- TWI: 20 (SDA) and 21 (SCL). Support TWI communication using the Wire library. Note that these pins are not in the same location as the TWI pins on the old Duemilanove or Diecimila Arduino boards.
- Analog: The Mega 2560 has 16 analog inputs, each of which provide 10 bits of resolution (i.e. 1024 different values). By default they measure from ground to 5 volts, though it is possible to change the upper end of their range using the AREF pin and `analogReference()` function.
- AREF: Reference voltage for the analog inputs. Used with `analogReference()`.
- Reset: Bring this line LOW to reset the microcontroller. Typically used to add a reset button to shields which block the one on the board.
- The no marked pins: Use them with operating the Register.

Install the Driver

First of all, you need to:

- **Get a Micro-USB cable** You need a Micro-USB cable first; the data cable of an Android Phone will do fine. If you can't find one, you can buy one [here](#).
- **Connect the board** Connect the Arduino board to your computer using the USB cable. The green power LED (labelled **PWR**) should go on.

For Windows

Note

This drive is available for Windows XP, Windows Vista, Windows 7, Windows 8/8.1 and Windows 10.

[Download Driver](https://github.com/SeeedDocument/Seeeduino_Mega/blob/master/img/download_driver.png?raw=true)

https://github.com/SeeedDocument/Seeeduino_Mega/blob/master/img/download_driver.png?raw=true

- Plug in your board and wait for Windows to begin its driver installation process. After a few moments, the process will fail, despite best efforts.
- Click on the Start Menu, and open up the Control Panel.
- While in the Control Panel, navigate to System and Security. Next, click on System. Once the System window is up, open the **Device Manager**.
- Look under Ports (COM & LPT). You should find an open port named "Seeeduino Mega". If there is no COM & LPT section, look under "Other Devices" for "Unknown Device".
- Right click on the "Seeeduino Mega" port and choose the "Update Driver Software" option.
- Next, choose the "Browse my computer for Driver software" option.
- Finally, navigate to and select the driver file named "Seeeduino Mega.inf"
- Windows will finish up the driver installation from there.

For Mac OSX

You don't need to install any drivers.

Getting Started

Note

This part is based on Arduino 1.6.9 under Windows 10.

First of all, you need to Install an Arduino Software.

Download Arduino IDE

<https://www.arduino.cc/en/Main/Software>

Launch the Arduino application

Double-click the Arduino application (arduino.exe) you have previously downloaded.

Note

If the Arduino Software loads in a different language, you can change it in the preferences dialog. See the [Arduino Software \(IDE\) page](#) for details.

Open the Blink example

Open the LED blink example sketch: **File > Examples > 01.Basics > Blink**.

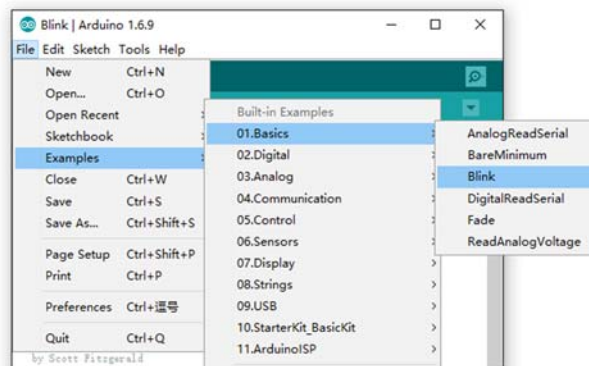

Add Seeeduino to your Arduino IDE

Click on **File > Preference**, and fill Additional Boards Manager URLs with below url: https://raw.githubusercontent.com/Seeed-Studio/Seeeduino-Boards/master/package_seeeduino_index.json

Click OK to finish the setting. Then Click on **Tools > Board > Boards Manager**, find **Seeeduino by Seeed Studio**, and Install it.

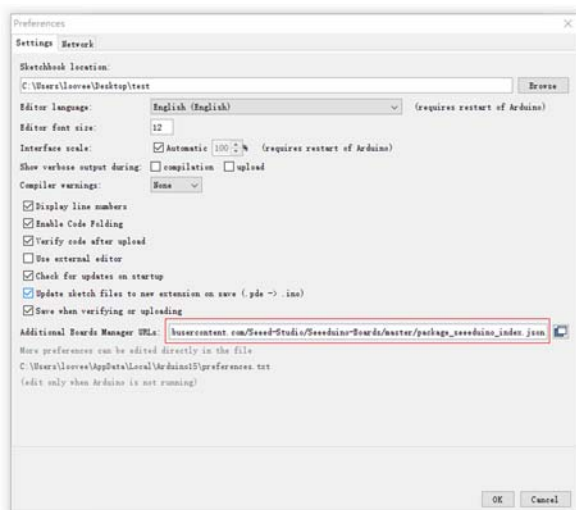

Select your board

You'll need to select the entry in the **Tools > Board** menu that corresponds to your Arduino. Selecting a **Seeeduino Mega 2560**.

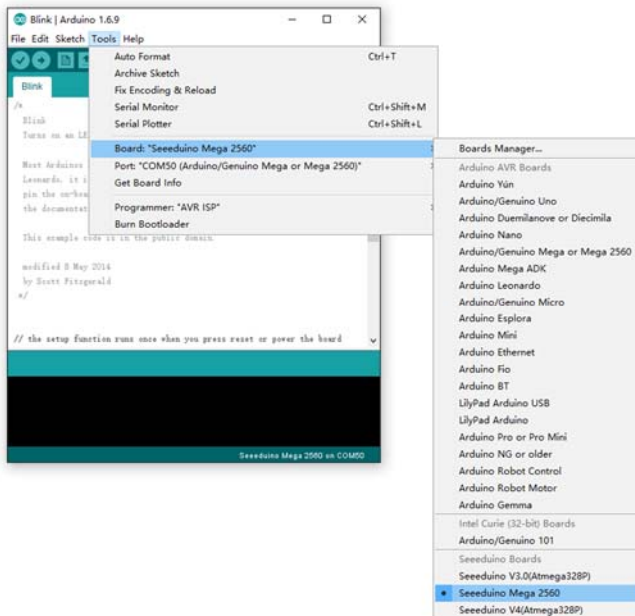

Select your serial port

Select the serial device of the Arduino board from the Tools | Serial Port menu. This is likely to be COM3 or higher (**COM1** and **COM2** are usually reserved for hardware serial ports). To find out, you can disconnect your Arduino board and re-open the menu; the entry that disappears should be the Arduino board. Reconnect the board and select that serial port.

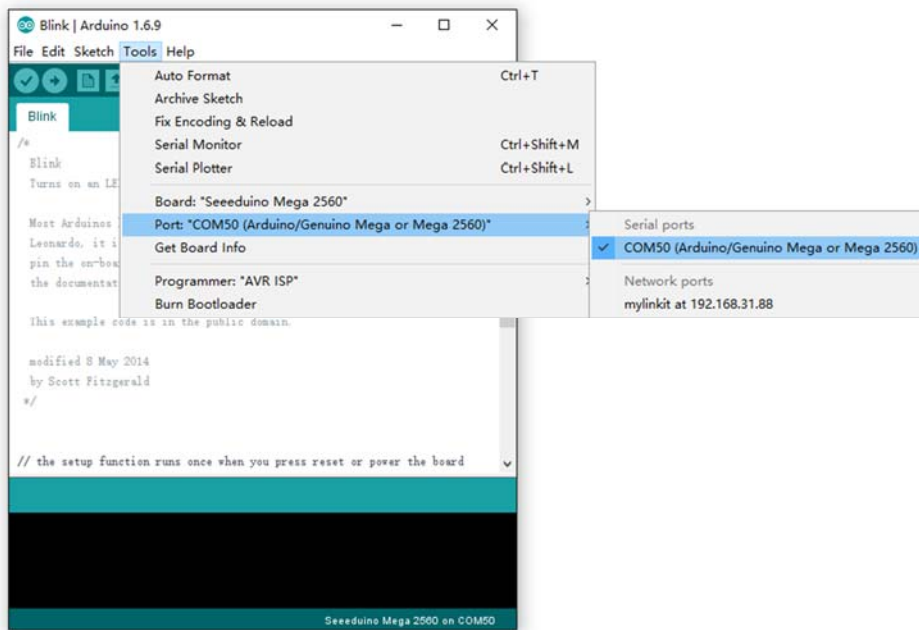

Note

On the Mac, this should be something with `/dev/tty.USBmodem`.

Upload the program

Now, simply click the "Upload" button in the environment. Wait a few seconds and if the upload is successful, the message "Done uploading." will appear in the status bar.

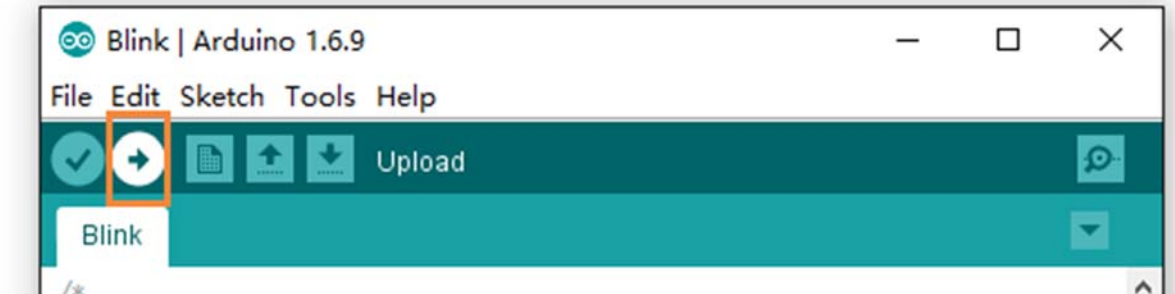

A few seconds after the upload finishes, you should see the pin 13 (L) LED on the board start to blink (in orange). If it does, congratulations! You've gotten Arduino up-and-running. If you have problems, please see the troubleshooting suggestions.

Getting Started on Linux

For using on Linux, please go to [Installing Arduino on Linux](#)

Resources

- **Schematic**

[Seeeduino Mega Eagle File](https://github.com/SeeedDocument/Seeeduino_Mega/blob/master/res/Seeeduino_Mega_v3.0.zip) https://github.com/SeeedDocument/Seeeduino_Mega/blob/master/res/Seeeduino_Mega_v3.0.zip

- **Pin Mapping**

[Seeeduino Mega Pin Mapping PDF](https://github.com/SeeedDocument/Seeeduino_Mega/blob/master/res/Seeeduino%20Mega%20pin%20mapping.pdf)
https://github.com/SeeedDocument/Seeeduino_Mega/blob/master/res/Seeeduino%20Mega%20pin%20mapping.pdf

- **References**

[Getting Started with Arduino](https://www.arduino.cc/en/Guide/HomePage) <https://www.arduino.cc/en/Guide/HomePage>

[Arduino Language Reference](https://www.arduino.cc/en/Reference/HomePage) <https://www.arduino.cc/en/Reference/HomePage>

[Download the Arduino Software\(IDE\)](https://www.arduino.cc/en/Main/Software) <https://www.arduino.cc/en/Main/Software>

[Arduino FAQ](https://www.arduino.cc/en/Main/FAQ) <https://www.arduino.cc/en/Main/FAQ>

[Arduino Introduction](https://www.arduino.cc/en/guide/introduction) <https://www.arduino.cc/en/guide/introduction>

[Wikipedia page for Arduino](https://en.wikipedia.org/wiki/Arduino) <https://en.wikipedia.org/wiki/Arduino>

[Arduino Mega](https://www.arduino.cc/en/Main/ArduinoBoardMega2560?setlang=en) <https://www.arduino.cc/en/Main/ArduinoBoardMega2560?setlang=en>

FAQ

What is the different between Arduino Mega with Seeeduino Mega?

Seeeduino Mega is a powerful microcontroller derived from Arduino Mega. And there are the mainly difference list:

- Use a mini USB to power and program
- Add 3.3V system power switch
- Add automatic reset mode switch
- Smaller size

Tech Support

Please submit any technical issue into our [forum](#) or drop mail to techsupport@seeed.cc.