

# Agilent U2000 Series USB Power Sensors

Data Sheet

**The compact, low-cost alternative to conventional power measurement solutions**



**Agilent Technologies**

## Why Agilent's power meters and sensors?



### **Reliable, high-performing solutions**

*Every power meter and sensor from Agilent consistently delivers great results.*



### **A sure investment for many years to come**

*Code-compatibility between power meters reduces the need for re-coding. Not only that, all Agilent power meters are backward-compatible with most legacy power sensors.*



### **One specific application: One right solution**

*Agilent offers a wide selection of power meters and sensors for practically all application needs—wireless communications, radar pulse measurements, component test and more.*



### **Global network support**

*No matter where you are, Agilent is committed to giving you the 24-hour support you need regarding our products, applications or services.*

*“Agilent’s power meters have long been recognized as the industry standard for RF and microwave power measurements.”*

# Compact solutions for testing today's RF and microwave communication systems

## For installation and maintenance of base stations



- Lightweight and rugged
- Simple set-up and usage
- Portable with low power consumption
- Wide dynamic and frequency ranges
- Quick and easy testing with large display of readings

## For production testing of wireless components



- Compact build saves rack space
- Simple set-up and usage
- Wide dynamic and frequency ranges
- Fast reading speed
- Internal zeroing reduces test time and sensor wear-and-tear
- Quick and easy multiple channels testing with simultaneous display of readings, limits and alerts
- Seamless integration to system with industry-standard SCPI

## For R&D of wireless components



- Compact build saves bench space
- Simple set-up and usage
- Wide dynamic and frequency ranges
- High accuracy
- Advanced troubleshooting of designs with simultaneous display of multiple readings, measurement math and data recording

# Introducing the U2000 Series USB power sensors

The U2000 Series enable simpler, lower-cost power measurements versus conventional power meter and sensor combinations. Now with nine high-performance models, the U2000 Series USB power sensors offer compact, high-performance solutions for today's CW and modulated signals.

### Key features

- Compact, lightweight solutions
- Quick, simple set-up
- High accuracy, high power
- Internal zeroing capability
- Fast reading speed
- Wide frequency range: 9 kHz to 24 GHz
- Wide dynamic range: -60 dBm to +44 dBm
- Allows remote measurements beyond cable length
- Enables monitoring of more than 20 channels simultaneously
- Converts select Agilent instruments to power meters
- Feature-packed software provides various capabilities for easy testing and analysis
- Average power measurements of CW and modulated signals, including GSM, EDGE, WLAN and WiMAX™



### Compact "power meters", simple set-up

The U2000 Series are standalone sensors. That means they essentially operate like power meters, just in smaller forms. No reference calibrator is required. The fact that each sensor draws minimal power from a USB port—and that it doesn't need additional triggering modules or power adaptors to operate—makes it more portable, especially for base station testing. Setting up is easy: just plug it to the USB port of your PC or laptop—or even select network or handheld spectrum analyzer—and start your power measurements. The figure below illustrates the very simple, straightforward setup of the U2000 Series.

### High accuracy

Each U2000 Series sensor provides excellent linearity, SWR and uncertainty specifications, so you can be confident in every measurement you make.

### Wide range, high power

The U2000 Series' dynamic range spans across a wide 80 dB, taking on high power up to +44 dBm.

### Remote monitoring and tests

With the U2000 Series sensor plugged to a networked USB hub, you can conveniently monitor power measurements of an antenna tower from the control room, beyond the limits of USB cable lengths.

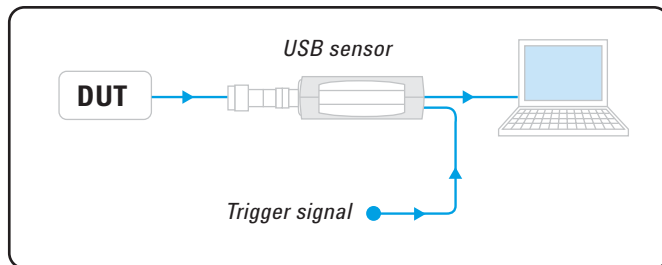

# Introducing the U2000 Series USB power sensors (continued)

## Faster production testing of multiple channels

The U2000 Series' fast measurement speed of 1000 readings/s in buffered mode helps reduce test time. This, coupled with the capability to enable monitoring of more than 20 channels simultaneously, is an advantage in the production line where efficiency is of utmost priority.

The U2000 Series has both internal and external zeroing capabilities. With internal zeroing, high isolation switches in the sensor are opened to isolate the sensor from the device-under-test (DUT) it is connected to. As such, you don't need to power-off the DUT or disconnect the sensors. This speeds up testing and reduces sensor wear-and-tear.

No manual input of calibration data is required. All calibration factors, as well as temperature and linearity corrections, are stored in the sensors' EEPROM, auto-downloaded at calibration.

Often times, you'd need to automate your tests. The U2000 Series sensors are well-equipped for seamless integration to your system with industry-standard SCPI compatibility. They also come with built-in triggering capability to allow receipt of external triggers from other instruments.

## Transform your signal generators and spectrum analyzers into accurate power meters

You could literally have a power meter next to you—or instead, turn your Agilent MXG signal generator or N9340A/B handheld spectrum analyzer into a power meter for accurate power measurements. Even with the U2000 connected, you can switch between power measurements and the device's original function at any time. You can also use the U2000 with your Agilent PNA network analyzer for source power calibration.



## Intuitive power analysis software

The N1918A Power Analysis Manager software not only displays measurements with the U2000 Series, it also provides various features and functions to help you monitor and troubleshoot signals efficiently and effectively.



Multiple display types<sup>1</sup>

Multiple channel list and measurement math

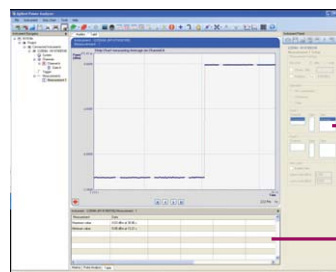
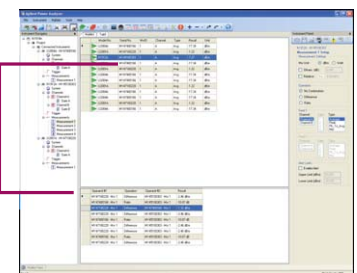

Data recording with limit and alert settings<sup>1</sup>

Min/Max readings

1. Software capability differs between the two versions of the software: Power Panel and Power Analyzer. Please refer to Page 17 for detailed comparison



## Take a closer look

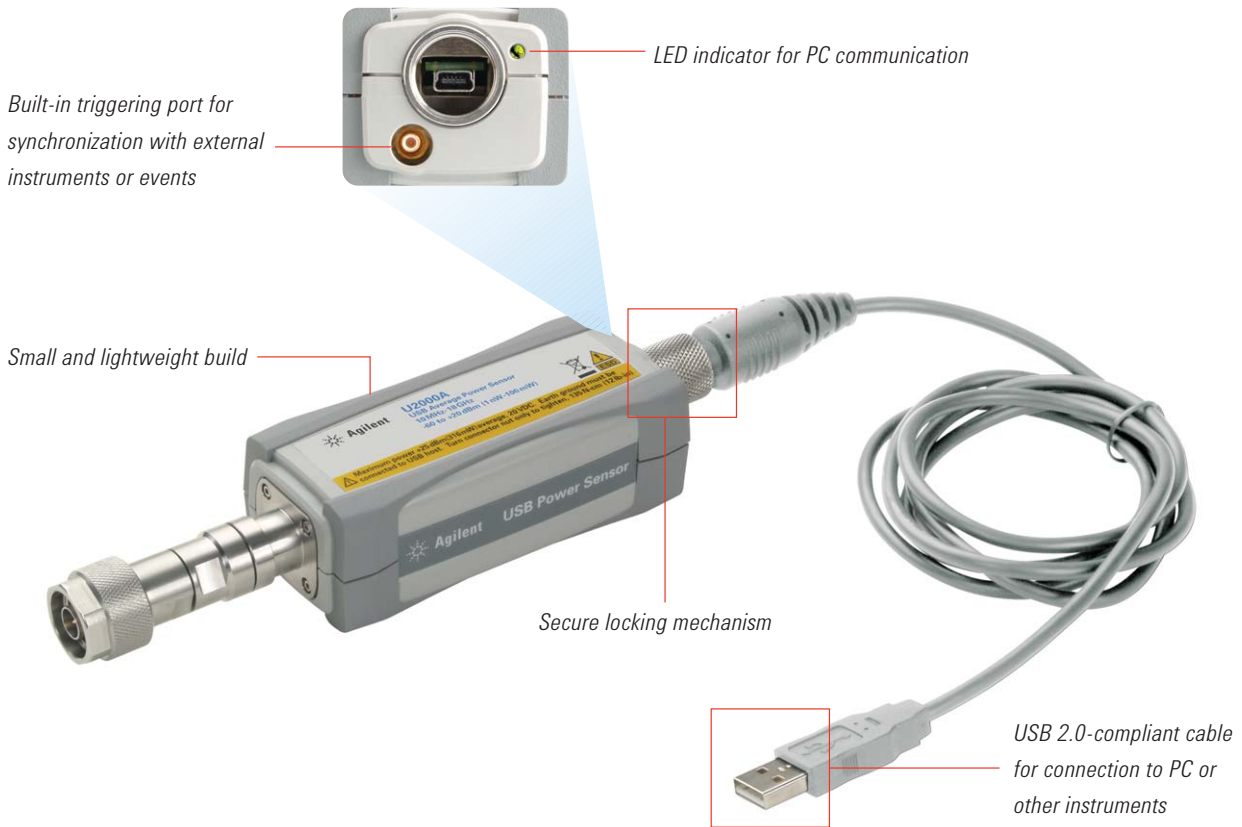

Diode-based sensors frequently rely on the application of correction factors to extend their dynamic range beyond their square-law region, typically in the range of  $-70$  dBm to  $-20$  dBm. While this technique achieves measurement of CW signals over a wide dynamic range, it fails to do so for modulated signals when the signal level is above the square-law region. Modulated signals must be padded down, with their average and peak power levels within the diode square-law region, for accurate average power measurement.

The U2000 Series USB power sensors are true-average, wide-dynamic-range RF/microwave power sensors, based on a dual-sensor diode pair/attenuator/diode pair topology as proposed by Szente et. al. in 1990<sup>1</sup>. The simplified block diagram shown here illustrates this technique.

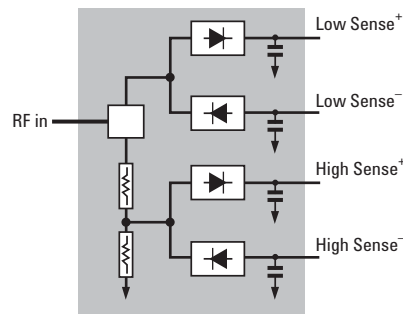

This technique ensures diodes in the selected signal path are kept in their square law region—with output current and voltage proportional to input power. The diode pair/attenuator/diode pair assembly can then yield the average of complex modulation formats across a wide dynamic range, irrespective of signal bandwidth.

The dual-range Modified Barrier Integrated Diode (MBID)<sup>2</sup> package incorporates diode stacks in place of single diodes. This further improves measurement accuracy of high-level signals with high crest factors without incurring damage<sup>3</sup> to the sensor.

Implementation of both techniques in the U2000 Series USB sensors enable effective average power measurements of a wide range of signals, including multitone and spread spectrum signals used in CDMA, W-CDMA and digital television systems.

1. US Patent #4943764, assigned to Hewlett-Packard Company.

2. November 1986 Hewlett-Packard Journal pages 14-2, "Diode Integrated Circuits for Millimeter-Wave Applications."

3. Refer to "Maximum Power" on page 9 for maximum power handling specifications.

# Specifications

Specifications contained in this chapter are valid ONLY after proper calibration of the power sensor and apply to continuous wave (CW) signals unless otherwise stated. The recommended calibration interval for this product is 1 year. Specifications apply over a temperature range 0 °C to +55 °C unless otherwise stated. Specifications quoted over a temperature range of 25 °C ± 10 °C apply to a relative humidity of 15% to 75% and conform to the standard environmental test conditions. Specifications are valid after a 30-minute warm-up period.

Supplemental characteristics, shown in italics, are intended to provide useful information with regard to applying the power sensors in that they contain typical, but non-warranted performance parameters. These characteristics are shown in italics or denoted as “*typical*”, “*nominal*” or “*approximate*”.

## Measurement speed

**Normal:** 20 readings/s

**x2:** 40 readings/s

**Fast:** 110 readings/s

**Buffered (50 readings):** 1000 readings/s

## Frequency and power ranges

Model	Frequency range	Power range	Maximum power
U2000A	10 MHz to 18 GHz	-60 dBm to +20 dBm	+25 dBm avg, 20 VDC
U2001A	10 MHz to 6 GHz		+33 dBm pk, <10 μs
U2002A	50 MHz to 24 GHz		
U2004A	9 kHz to 6 GHz	-60 dBm to +20 dBm	+25 dBm avg, 5 VDC +33 dBm pk, <10 μs
U2000B	10 MHz to 18 GHz	-30 dBm to +44 dBm	+45 dBm avg, 20 VDC
U2001B	10 MHz to 6 GHz		+47 dBm pk, 1 μs
U2000H	10 MHz to 18 GHz	-50 dBm to +30 dBm	+33 dBm avg, 20 VDC
U2001H	10 MHz to 6 GHz		+50 dBm pk, 1 μs
U2002H	50 MHz to 24 GHz		+33 dBm avg, 10 VDC +50 dBm pk, 1 μs

## Maximum SWR

Model	Frequency range	Max SWR (25 °C ± 10 °C)	Max SWR (0 °C to 55 °C)
U2000A	10 MHz to 30 MHz	1.15	1.21
	30 MHz to 2 GHz	1.13	1.15
	2 GHz to 14 GHz	1.19	1.20
	14 GHz to 16 GHz	1.22	1.23
	16 GHz to 18 GHz	1.26	1.27
U2001A	10 MHz to 30 MHz	1.15	1.21
	30 MHz to 2 GHz	1.13	1.15
	2 GHz to 6 GHz	1.19	1.20
U2002A	50 MHz to 2 GHz	1.13	1.15
	2 GHz to 14 GHz	1.19	1.20
	14 GHz to 16 GHz	1.22	1.23
	16 GHz to 18 GHz	1.26	1.27
	18 GHz to 24 GHz	1.30	1.30
U2004A	9 kHz to 2 GHz	1.13	1.15
	2 GHz to 6 GHz	1.19	1.20
U2000B	10 MHz to 2 GHz	1.12	1.14
	2 GHz to 12.4 GHz	1.17	1.18
	12.4 GHz to 18 GHz	1.24	1.25
U2001B	10 MHz to 2 GHz	1.12	1.14
	2 GHz to 6 GHz	1.17	1.18
U2000H	10 MHz to 8 GHz	1.15	1.17
	8 GHz to 12.4 GHz	1.25	1.26
	12.4 GHz to 18 GHz	1.28	1.29
U2001H	10 MHz to 6 GHz	1.15	1.17
U2002H	50 MHz to 8 GHz	1.15	1.17
	8 GHz to 12.4 GHz	1.25	1.26
	12.4 GHz to 18 GHz	1.28	1.29
	18 GHz to 24 GHz	1.30	1.31

## Specifications (continued)

Typical SWR for U2000A sensor  
(25 °C ± 10 °C)

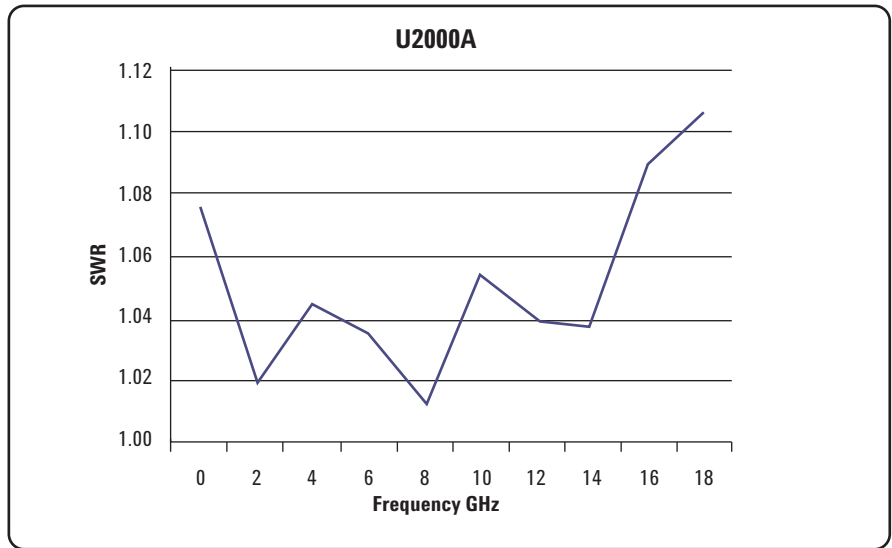

Typical SWR for U2001A sensor  
(25 °C ± 10 °C)

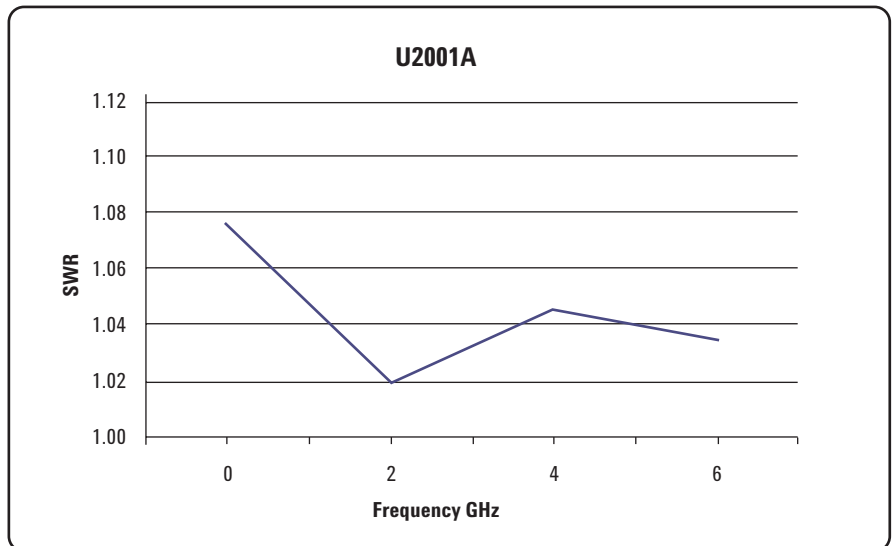

Typical SWR for U2002A sensor  
(25 °C ± 10 °C)

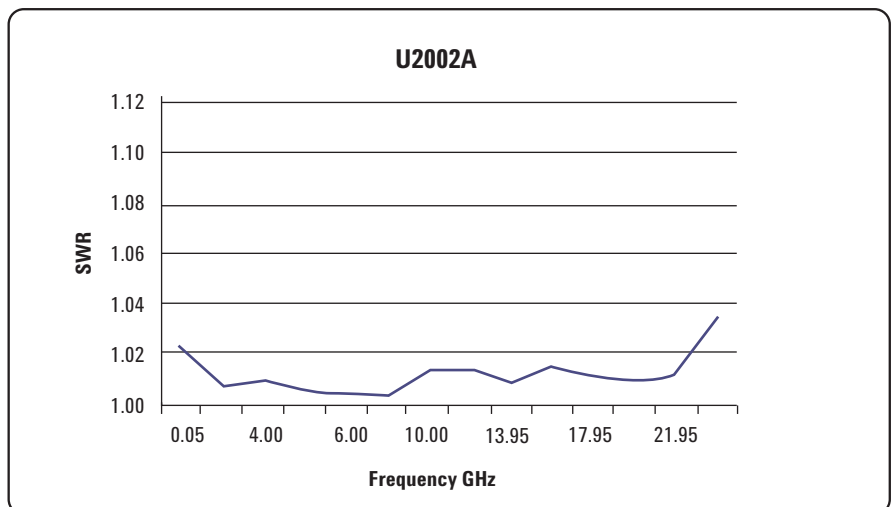



## Specifications (continued)

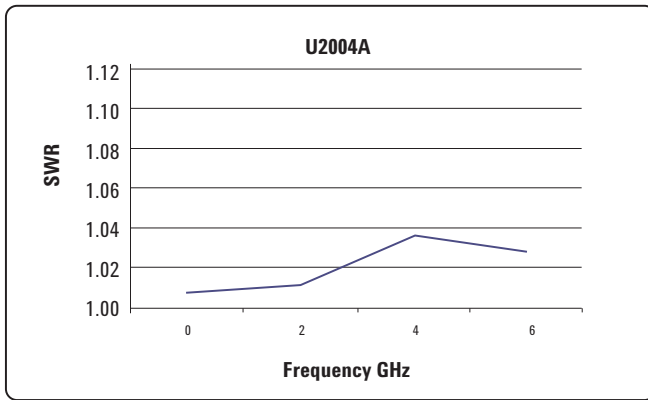

Typical SWR for U2004A sensor (25 °C ± 10 °C)

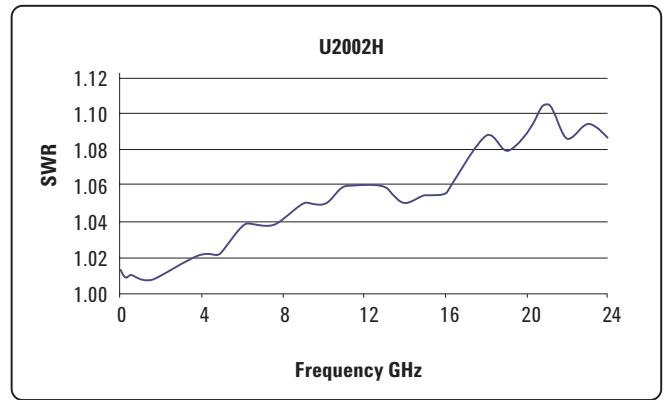

Typical SWR for U2002H sensor (25 °C ± 10 °C)

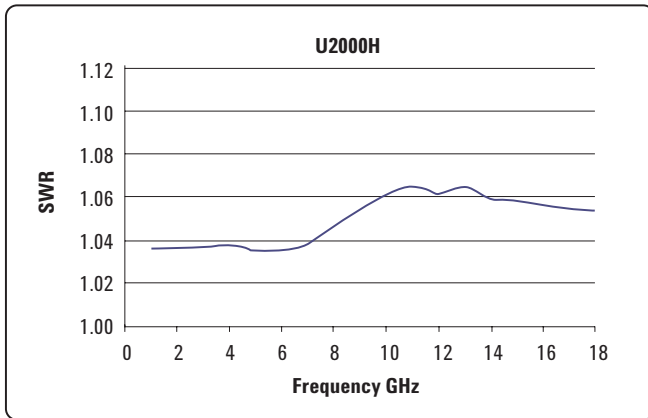

Typical SWR for U2000H sensor (25 °C ± 10 °C)

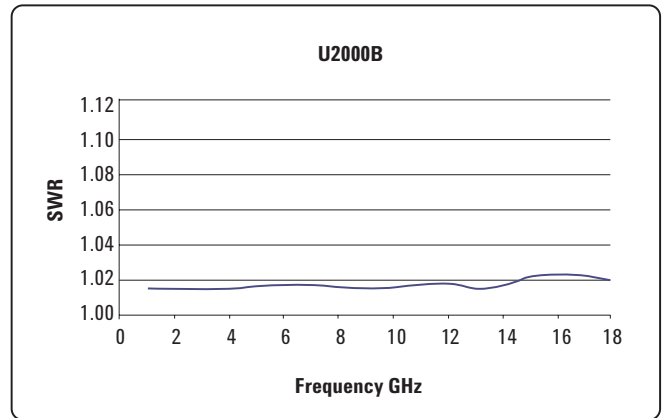

Typical SWR for U2000B sensor (25 °C ± 10 °C)

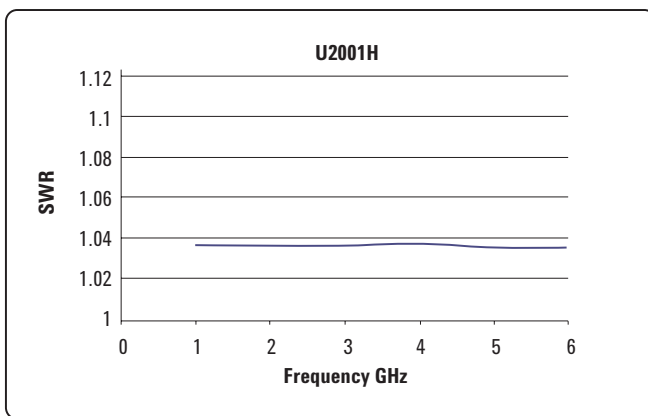

Typical SWR for U2001H sensor (25 °C ± 10 °C)

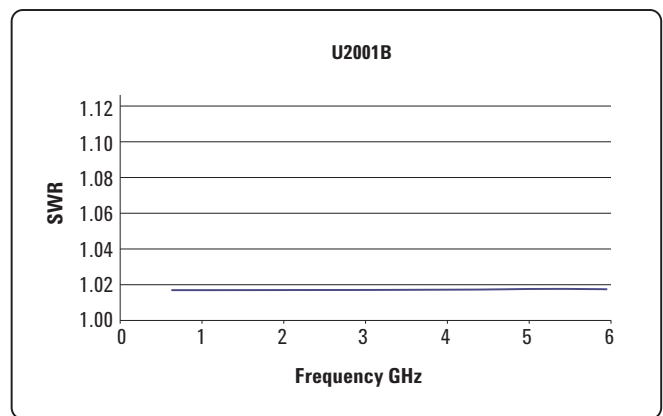

Typical SWR for U2001B sensor (25 °C ± 10 °C)

## Specifications (continued)

### Switching point

The U2000 Series power sensors have two measurement paths: a low power path and a high power path, as shown in the table below.

Models	AUTO (default) range	Low power path	High power path	Switching point
U2000/1/2/4A	-60 dBm to +20 dBm	-60 dBm to -10 dBm	-10 dBm to +20 dBm	-10 dBm
U2000/1/2H	-50 dBm to +30 dBm	-50 dBm to 0 dBm	0 dBm to +30 dBm	0 dBm
U2000/1B	-30 dBm to +44 dBm	-30 dBm to +20 dBm	+20 dBm to +44 dBm	+20 dBm

Each power sensor automatically selects the proper power level path. To avoid unnecessary switching when the power level is close to the switching point, switching point hysteresis has been added.

**Offset at switching point:**  $\leq \pm 0.5\%$  ( $\leq \pm 0.02$  dB) typical

**Switching point hysteresis:** 1 dB typical

#### Example with U2000 "A" suffix sensors:

Switching point for the U2000/1/2/4A sensors is at -10 dBm. Hysteresis causes the low power path to remain selected until approximately -9 dBm as the power level is increased. Above this power, the high power path is selected. The high power path remains selected until approximately -11 dBm is reached as the signal level decreases. Below this power, the low power path is selected.

### Power Accuracy

Model	Power range	Accuracy <sup>1</sup> (25 °C ± 10 °C)	Accuracy <sup>1</sup> (0 °C to 55 °C)
U2000/1/2/4A	-60 dBm to +20 dBm	±3.0%	±3.5%
U2000/1/2H	-50 dBm to +30 dBm	±4.0%	±5.0%
U2000/1B	-30 dBm to +44 dBm	±3.5%	±4.0%

Specifications valid with the following conditions:

- After zeroing
- Number of averages = 1024
- After 30 minutes of power-on warm-up

1. This accuracy is essentially a combination of linearity, instrumentation accuracy, and traceability to absolute accuracy at 50 MHz, 0 dBm. Note: Mismatch uncertainty, calibration factor uncertainty, and power level dependent terms (zero set, drift, and noise) are excluded in this specification and specified elsewhere in the data sheet.

## Specifications (continued)

Typical power accuracy at 25 °C for U2000/1/2/4A sensors<sup>1</sup>

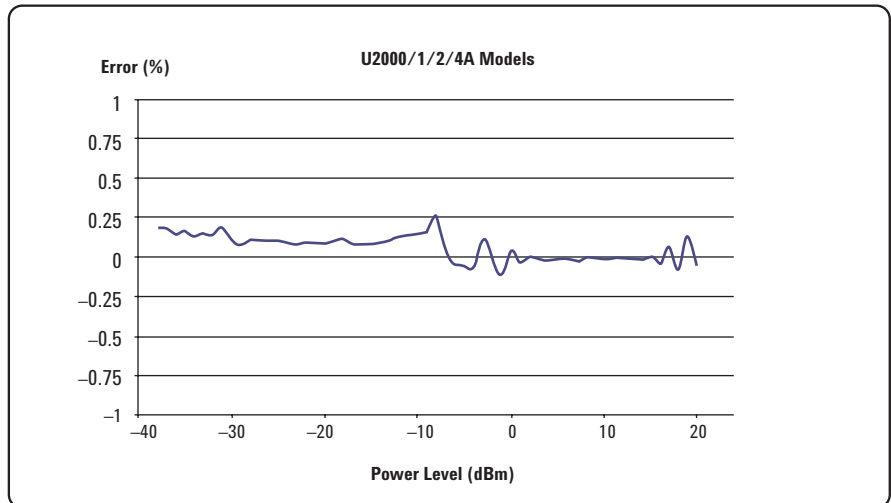

Typical power accuracy at 25 °C for U2000/1B sensors<sup>1</sup>

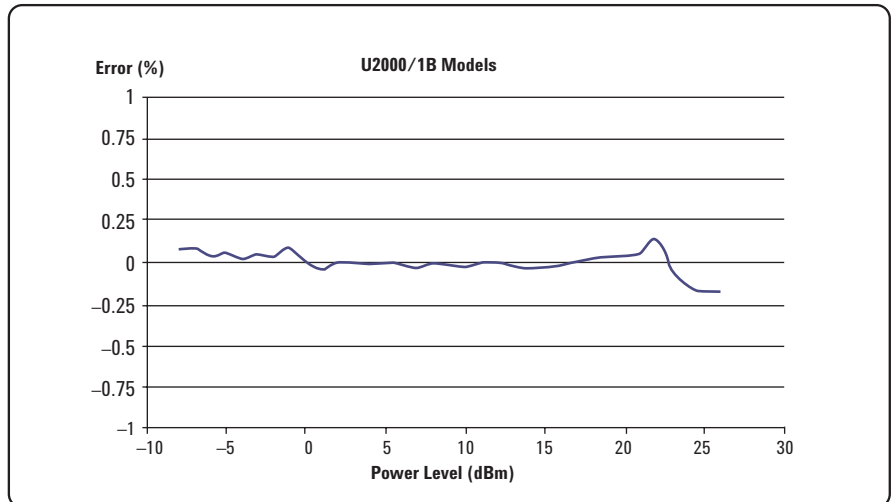

Typical power accuracy at 25 °C for U2000/1/2H sensors<sup>1</sup>

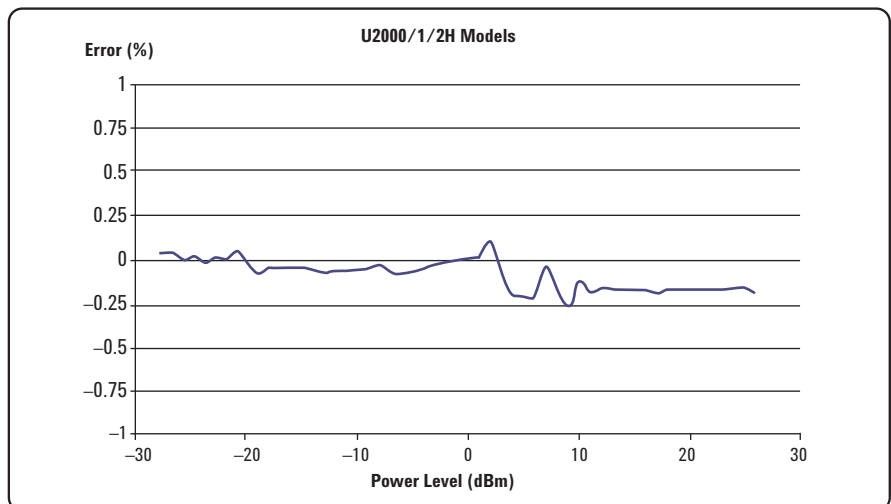

1. Measurement uncertainty  $\leq 1.6\%$ . At room temperature and excluding power level dependent terms (zero set, drift and noise)

## Specifications (continued)

### Zero and measurement noise

Power range <sup>1</sup>	Zero set (internal)	Zero set (external)	Zero drift <sup>2</sup>	Measurement noise <sup>3</sup>	Noise Per Sample <sup>4</sup>
<b>U2000/1/2/4A sensors</b>					
-60 dBm to -35 dBm	±1.5 nW (±2.8 nW for U2004A)	±600 pW	200 pW	1 nW	N/A
-38 dBm to -15 dBm	±2 nW (±3 nW for U2004A)	±1.5 nW	400 pW	1.5 nW	90 nW
-20 dBm to -9 dBm	±12 nW	±10 nW	1.5 nW	15 nW	1 µW
-11 dBm to -5 dBm	±2 µW	±500 nW	50 nW	650 nW	55 µW
-7 dBm to 15 dBm	±4 µW	±1 µW	500 nW	1 µW	85 µW
10 dBm to 20 dBm	±6 µW	±5 µW	2 µW	10 µW	550 µW
<b>U2000/1/2H sensors</b>					
-50 dBm to -25 dBm	±15 nW	±8 nW	2 nW	10 nW	N/A
-28 dBm to -5 dBm	±20 nW	±20 nW	4 nW	15 nW	900 nW
-10 dBm to 1 dBm	±120 nW	±100 nW	15 nW	150 nW	10 µW
-1 dBm to 5 dBm	±20 µW	±20 µW	500 nW	6.5 µW	550 µW
3 dBm to 25 dBm	±40 µW	±30 µW	5 µW	10 µW	850 µW
20 dBm to 30 dBm	±60 µW	±60 µW	20 µW	100 µW	5.5 mW
<b>U2000/1B sensors</b>					
-30 dBm to -5 dBm	±1.8 µW	±800 nW	200 nW	1 µW	N/A
-8 dBm to 15 dBm	±2 µW	±2 µW	400 nW	1.5 µW	90 µW
10 dBm to 21 dBm	±12 µW	±10 µW	1.5 µW	15 µW	1 mW
19 dBm to 25 dBm	±2 mW	±1 mW	50 nW	650 µW	55 mW
23 dBm to 44 dBm	±4 mW	±2 mW	500 µW	1 mW	85 mW

**Effects of averaging on noise:** Averaging over 1 to 1024 readings is available for reducing noise. The table below provides the measurement noise for a particular sensor with the number of averages set at 16 (for normal mode) and 32 (for x2 mode). Use the noise multiplier, for the appropriate number of averages, to determine the total measurement noise value.

**Example:**

U2000A power sensor, -60 dBm to -35 dBm, normal mode, number of averages = 4

**Measurement noise calculation:**

$$1 \text{ nW} \times 1.7 = 1.7 \text{ nW}$$

No. of averages	1	2	4	8	16	32	64	128	256	512	1024
<b>Noise multiplier</b>											
Normal mode	2.0	1.8	1.7	1.5	1.0	0.95	0.74	0.55	0.39	0.29	0.21
x2 mode	2.7	2.4	2.0	1.6	1.0	0.91	0.78	0.53	0.34	0.29	0.20

1. Condition: (i) 0 °C to 55 °C and (ii) 95% relative humidity at 40 °C non-condensing.

2. Within one hour after zero set, at a constant temperature, after a 24-hour warm-up of the power sensor.

3. The number of averages at 16 for Normal mode, measured over a one-minute interval and two standard deviations.

4. Noise per sample specifications are not applicable to U2004A. They are only applicable for gated power working range as stated in the 'Gate' table on page 15.

## Specifications (continued)

### Settling time

#### Manual filter, 10-dB decreasing power step (not across switching points)

No. of averages	1	2	4	8	16	32	64	128	256	512	1024
<b>Settling time (s)</b>											
Normal mode	0.045	0.09	0.17	0.34	0.66	1.3	2.6	5.2	10.4	20.9	41.9
x2 mode	0.042	0.05	0.09	0.17	0.34	0.66	1.3	2.6	5.2	10.4	20.9

#### Auto filter, default resolution, 10-dB decreasing power step

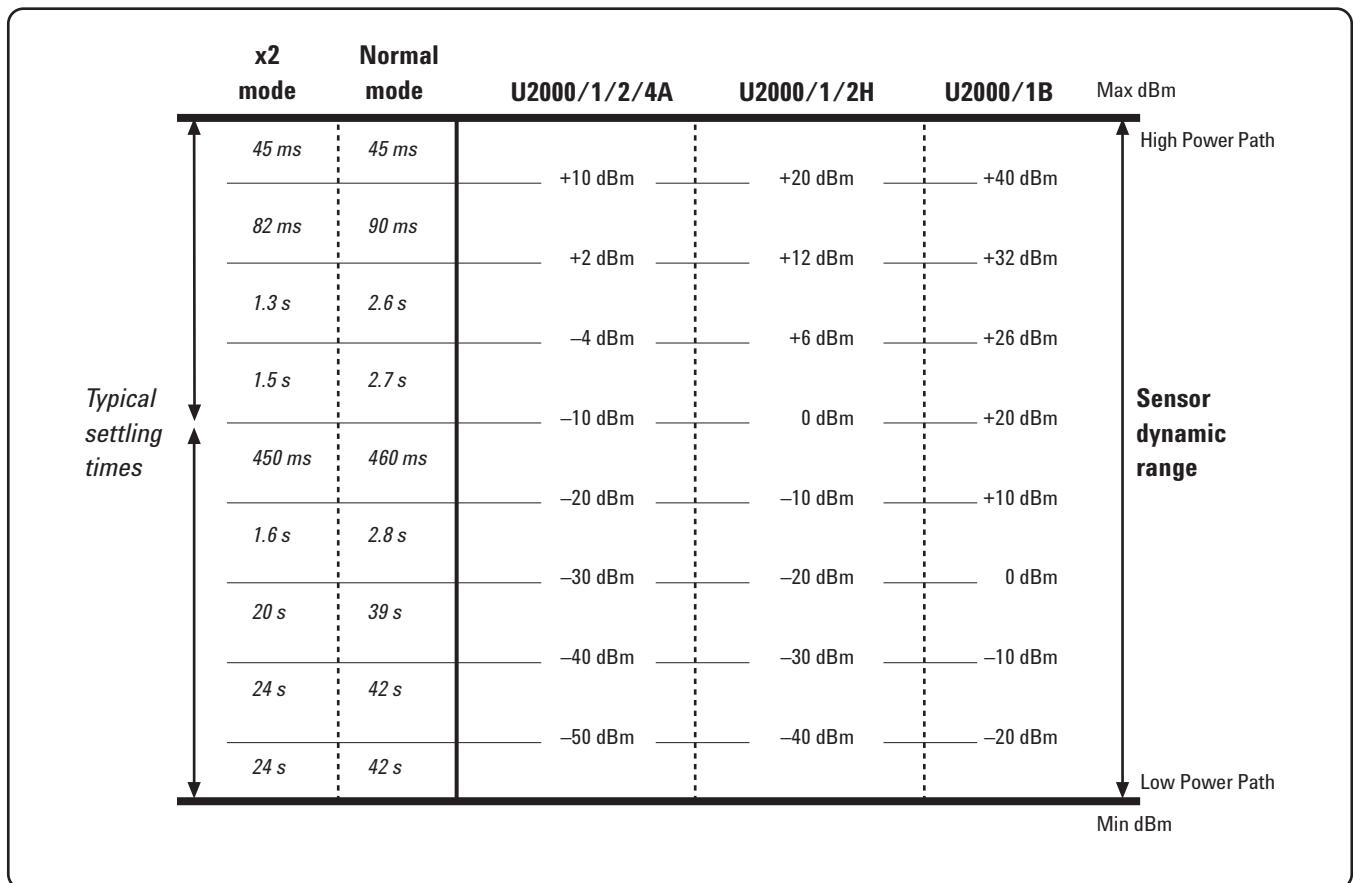

#### In Fast mode (using free run trigger), at 10-dB decreasing power step

Settling time = 25 ms\*

\* When a power step crosses through the sensor's auto-range switching point, add 25 ms.

## Specifications (continued)

### Calibration factor and reflection coefficient

Calibration factor (CF) and reflection coefficient (Rho) data is unique to each sensor. The CF corrects for the frequency response of the sensor. The reflection coefficient (Rho or  $\rho$ ) relates to the SWR based on the following formula:

$$SWR = \frac{1 + \rho}{1 - \rho}$$

Maximum uncertainties of the CF data are listed in the following table. There is only one set of CF data used for both high and low power paths of each sensor.

The uncertainty analysis for the calibration data was done in accordance with the ISO Guide. The uncertainty data reported on the calibration certificate is the expanded uncertainty with a 95% confidence level and a coverage factor of 2.

Frequency	Uncertainty (%) (25 °C ± 10 °C)
<b>U2000A sensor</b>	
10 MHz to 30 MHz	1.8
30 MHz to 2 GHz	1.6
2 GHz to 14 GHz	2.0
14 GHz to 16 GHz	2.2
16 GHz to 18 GHz	2.2
<b>U2001A sensor</b>	
10 MHz to 30 MHz	1.8
30 MHz to 2 GHz	1.6
2 GHz to 6 GHz	2.0
<b>U2002A sensor</b>	
50 MHz to 2 GHz	2.0
2 GHz to 14 GHz	2.5
14 GHz to 16 GHz	2.7
16 GHz to 18 GHz	2.7
18 GHz to 24 GHz	3.0
<b>U2004A sensor</b>	
9 kHz to 2 GHz	1.8
2 GHz to 6 GHz	1.8
<b>U2000B sensor</b>	
10 MHz to 2 GHz	1.8
2 GHz to 12.4 GHz	2.0
12.4 GHz to 18 GHz	2.2
<b>U2001B sensor</b>	
10 MHz to 2 GHz	1.8
2 GHz to 6 GHz	2.0
<b>U2000H sensor</b>	
10 MHz to 8 GHz	2.0
8 GHz to 12.4 GHz	2.0
12.4 GHz to 18 GHz	2.2
<b>U2001H sensor</b>	
10 MHz to 6 GHz	2.0
<b>U2002H sensor</b>	
50 MHz to 8 GHz	2.5
8 GHz to 12.4 GHz	2.5
12.4 GHz to 18 GHz	2.7
18 GHz to 24 GHz	3.0



## Specifications (continued)

### Trigger

Parameter	External TTL input
Trigger low	$< 1.1 V$
Trigger high	$> 1.9 V$
Minimum pulse width	$35 ns$
Maximum repetition period	$80 ns$
Latency	$11 \mu s \pm 2 \mu s$

### Gate<sup>1</sup>

Parameter	Performance
Sampling rate	1.47 Msps
Sweep and Offset	$0 s < \text{Sweep time} < 0.15 s$ $0 s < \text{Offset time} < 0.15 s$ <small>Note: Sweep time + Offset time <math>&lt; 0.15 s</math></small>
Resolution	$\pm 1 \mu s$
Power	U2000/1/2A: $-25 dBm$ to $+20 dBm$ U2000/1/2H: $-15 dBm$ to $+30 dBm$ U2000/1B: $+5 dBm$ to $+44 dBm$
Measurement speed <sup>2</sup>	10 ms/reading

1. Not applicable for the U2004A model

2. At conditions: Gate sweep time  $\leq 2 ms$ ; Gate sweep time + Gate offset  $< 2.3 ms$ ; FAST mode

# Specifications (continued)

## General specifications

Physical characteristics	
Dimensions (LxWxH)	<b>U2000/1/4A:</b> 163.75 mm x 46.00 mm x 35.90 mm <b>U2002A:</b> 134.37 mm x 46.00 mm x 35.90 mm <b>U2000/1B:</b> 308.00 mm x 115.00 mm x 84.00 mm <b>U2000/1H:</b> 207.00 mm x 46.00 mm x 36.00 mm <b>U2002H:</b> 164.00 mm x 46.00 mm x 36.00 mm
Weight	<b>U2000/1/4A:</b> 0.262 kg <b>U2002A:</b> 0.226 kg <b>U2000/1B:</b> 0.762 kg <b>U2000/1H:</b> 0.324 kg <b>U2002H:</b> 0.274 kg
Operating environment	
Temperature	0 °C to 55 °C
Humidity	Up to 95% relative humidity at 40 °C (non-condensing)
Altitude	Up to 4600 m (15,000 ft)
Pollution	Degree 2
Storage and shipment	
Environment	Sensor should be stored in a clean, dry environment
Temperature	-30 °C to +70 °C
Humidity	Up to 90% relative humidity at 65 °C (non-condensing)
Altitude	Up to 4600 m (15,000 ft)
Pollution	Degree 2
<b>Current requirement</b>	200 mA max (approx.)
<b>Connector</b>	<b>U2000/1/4A, U2000/1H, U2000/1B:</b> N-type (m), 50 Ω <b>U2002A, U2002H:</b> 3.5 mm (m), 50 Ω
<b>Cable</b>	USB 2.0 Type A to 5-pin Mini-B
<b>Programmability</b>	SCPI, Agilent VEE, LabVIEW, Microsoft® Visual Basic
<b>Safety and EMC compliance</b>	IEC 61010-1:2001/EN 61010-1:2001 (2nd edition) IEC 61326:2002 / EN61326:1997+A1:1998+A2:2001+A3:2003 Canada: ICES-001:2004 Australia/New Zealand: AS/NZS CISPR11:2004
<b>Calibration</b> <sup>1</sup>	1 year
<b>Warranty</b> <sup>1</sup>	1 year
<b>Compatible instruments</b>	Agilent N9340A/B handheld spectrum analyzers Agilent MXG signal generators Agilent PNA, PNA-L and PNA-X Series performance network analyzers

1. See "Ordering information" for available options

# Using the U2000 Series with the N1918A Power Analysis Manager

The N1918A software is available in two versions: the basic Power Panel and advanced Power Analyzer. Power Analyzer provides full access to the software's complete features and capabilities and its license, N1918A-Option 100, is available for purchase separately. A free, fully functional trial version of the Power Analyzer is accessible for 30 days upon installation from the bundled N1918A Power Analysis Manager CD. The table here shows functions accessible with each version when used with the U2000 Series.

	Power Panel (basic)	Power Analyzer (advanced)
<b>Measurement display functions</b>		
Soft panel (digital) display	✓	✓ Enhanced with limit and alert notifications
Gauge (analog) display	✓	✓ Enhanced with limit and alert notifications
Strip chart display	✓	✓
Multiple tabs	✗	✓
Multiple displays per tab	✓ Up to 2 displays	✓ Up to 3 displays
Multilist (List view of multiple channels)	✓	✓
<b>Graph functions</b>		
Single marker	✓ Up to 2 markers per graph	✓ Up to 10 markers per graph
Dual marker	✗	✓ Up to 5 sets of markers per graph
Graph autoscaling	✓	✓
Graph zooming	✓	✓
Measurement math	✓ Delta and ratio	✓ Delta and ratio
<b>Save/Load file functions</b>		
Save measurement data (with timestamp)	✓ Applies to strip chart displays; up to 10,000 data points	✓ Applies to strip chart displays
Load measurement data	✓ Applies to strip chart displays	✓ Applies to strip chart displays
Data recording (with timestamp)	✗	✓ Applies to soft panel, gauge and strip chart displays; up to 7 days
<b>Limit and alert functions</b>		
Limit and alert notifications	✗	✓
Alert summary	✗	✓
<b>Instrument setting options</b>		
Save/Restore instrument settings	✓	✓
Gate settings	✓	✓
FDO table parameters	✓	✓
<b>Print option</b>		
Print application screen	✓	✓

For further details on the software, refer to "N1918A Power Analysis Manager Data Sheet", literature number 5989-6612EN.

**Display units:**

Absolute: Watts or dBm  
Relative: Percent or dB

**Display resolution:**

Resolution of 1.0, 0.1, 0.01 and 0.001 dB in log mode; one to four digits in linear mode.

**Default resolution:**

0.01 dB in log mode; three digits in linear mode

**Zero:** For performing internal and external zeroing.

**Range:** Sensor-dependent, configurable in 1-kHz steps.

**Relative:** Displays all successive measurements relative to the last referenced value.

**Offset:** Allows power measurements to be offset by -100 dB to +100 dB, configurable in 0.001 dB increments, to compensate for external loss or gain.

**Duty cycle:** Duty cycle values between 0.001% to 99.999% can be entered in increments of 0.01% to display a pulse power representation of measured power. The following equation is used to calculate the displayed pulse power value:  $\text{Pulse Power} = \text{Measured Power} / \text{Duty Cycle}$

**Limits:** High and low limits can be set in the range between -150.00 dBm to +230.000 dBm, in 0.001 dBm increments.

**Preset default values:** Channel Offset (dB) = 0, Duty Cycle Off, Frequency 50 MHz, AUTO Average, AUTO Range, Free Run Mode, dBm mode.

## Using the U2000 Series with the N1918A Power Analysis Manager (continued)

### System requirements

Hardware	
Processor	<b>Desktop PC:</b> 1.3 GHz Pentium® IV or higher recommended <b>Laptop PC:</b> 900 MHz Pentium® M or higher recommended
RAM	512 MB (1.0 GB or higher recommended)
Hard disk space	1.0 GB or more free disk space at runtime
Resolution	800 x 600 or higher (1280 x 1024 recommended)
Operating system and browser	
Operating system	Windows® XP Professional, service pack 2 or higher
Browser	Microsoft Internet Explorer 5.1 (6.0 or higher recommended)
Software	
Agilent IO Libraries Suite <sup>1</sup>	Version 14.2 <sup>2</sup> or higher
Microsoft .NET Framework <sup>3</sup>	Runtime version 2.0
Microsoft Visual C++ 2005 Runtime Libraries <sup>3</sup>	Version 1.0 or higher

1. Available in Agilent Automation-Ready CD

2. Agilent IO Libraries Suite 15.0 is required if PC is running on Microsoft Windows Vista 32-bit edition

3. Bundled with N1918A Power Analysis Manager CD

# Ordering information

## Power sensors

Models	Description
U2000A	Items shipped as standard with each sensor:
U2001A	<ul style="list-style-type: none"> <li>BNC (m) to SMB (f) trigger cable, 1.5 m, 50 Ω</li> </ul>
U2002A	<ul style="list-style-type: none"> <li>USB 2.0 Type A to 5-pin Mini-B cable with secure locking mechanism, selectable lengths of</li> </ul>
U2004A	<ul style="list-style-type: none"> <li>1.5 m, 3.0 m or 5.0 m</li> </ul>
U2000H	<ul style="list-style-type: none"> <li>U2000 Series USB Power Sensor Programming Guide</li> </ul>
U2001H	<ul style="list-style-type: none"> <li>U2000 Series USB Power Sensor Operating and Service Guide (English)</li> </ul>
U2002H	<ul style="list-style-type: none"> <li>U2000 Series USB Power Sensor Documentation CD (contains Agilent RFPowerMeter IVI driver)</li> </ul>
U2000B	<ul style="list-style-type: none"> <li>Certificate of Calibration</li> </ul>
U2001B	<ul style="list-style-type: none"> <li>N1918A Power Analysis Manager Installation Guide</li> <li>N1918A Power Analysis Manager CD</li> <li>Agilent Automation-Ready CD (contains Agilent IO Libraries Suite)</li> </ul>

## Accessories, calibration and documentation options

Cables	Description
U2031A	USB 2.0 Type A to 5-pin Mini-B cable with secure locking mechanism, 1.5 m (5 ft)
U2031B	USB 2.0 Type A to 5-pin Mini-B cable with secure locking mechanism, 3.0 m (10 ft)
U2031C	USB 2.0 Type A to 5-pin Mini-B cable with secure locking mechanism, 5.0 m (16.4 ft)
U2032A	BNC (m) to SMB (f) trigger cable, 1.5 m, 50 Ω
Travel kits	Description
U2000A-201	Transit case
U2000A-202	Soft carrying case
U2000A-204	Soft carrying pouch
Hanging kit	Description
U2000A-203	Holster
Calibration	Description
Option 1A7	ISO 17025 calibration with test data
Option A6J	ANSI Z540 calibration with test data
Warranty	Description
Option R-51B-001-3C	Extension of warranty and service plan from 1 year to 3 years
Option R-51B-001-5C	Extension of warranty and service plan from 1 year to 5 years
Documentation	Description
Option OB1	English language Operating and Service Guide
Option ABD	German language Operating and Service Guide
Option ABE	Spanish language Operating and Service Guide
Option ABF	French language Operating and Service Guide
Option ABJ	Japanese language Operating and Service Guide
Option ABZ	Italian language Operating and Service Guide
Option AB2	Simplified Chinese language Operating and Service Guide
Software	Description
N1918A-100	N1918A Power Analysis Manager software, advanced Power Analyzer version
Complementary I/O connectivity hardware	Description
E5813A <sup>1</sup>	Networked 5-port USB hub

1. Refer to [www.agilent.com/find/e5813a](http://www.agilent.com/find/e5813a) for more information on the device.

**Ordering information (continued)**



*Transit case*



*Soft carrying case*



*Soft carrying pouch*

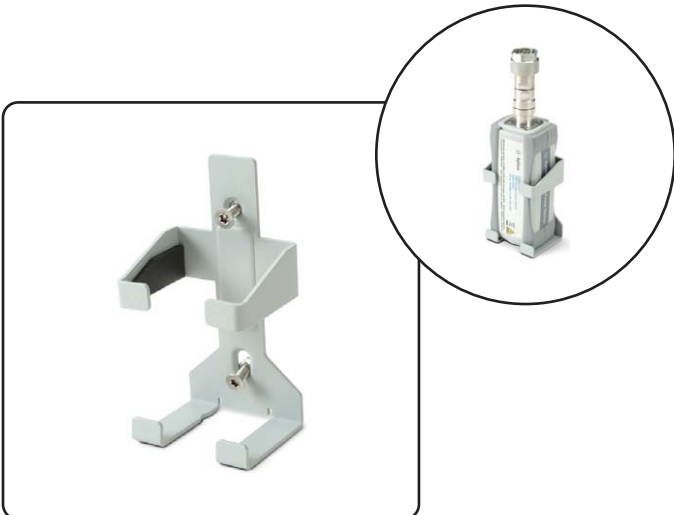

*Holster*





### Agilent Email Updates

[www.agilent.com/find/emailupdates](http://www.agilent.com/find/emailupdates)  
Get the latest information on the products and applications you select.



### Agilent Direct

[www.agilent.com/find/agilentdirect](http://www.agilent.com/find/agilentdirect)  
Quickly choose and use your test equipment solutions with confidence.



[www.agilent.com/find/open](http://www.agilent.com/find/open)  
Agilent Open simplifies the process of connecting and programming test systems to help engineers design, validate and manufacture electronic products. Agilent offers open connectivity for a broad range of system-ready instruments, open industry software, PC-standard I/O and global support, which are combined to more easily integrate test system development.

WiMAX is a trademark of the WiMAX Forum. Windows and Microsoft are U.S. registered trademarks of Microsoft Corporation. Pentium is a U.S. registered trademark of Intel Corporation. cdma2000 is a registered certification mark of the Telecommunications Industry Association. Used under license. Bluetooth is a trademark owned by Bluetooth SIG, Inc., U.S.A. and licensed to Agilent Technologies, Inc.

### Remove all doubt

Our repair and calibration services will get your equipment back to you, performing like new, when promised. You will get full value out of your Agilent equipment throughout its lifetime. Your equipment will be serviced by Agilent-trained technicians using the latest factory calibration procedures, automated repair diagnostics and genuine parts. You will always have the utmost confidence in your measurements.

Agilent offers a wide range of additional expert test and measurement services for your equipment, including initial start-up assistance onsite education and training, as well as design, system integration, and project management.

For more information on repair and calibration services, go to

[www.agilent.com/find/removealldoubt](http://www.agilent.com/find/removealldoubt)

Product specifications and descriptions in this document subject to change without notice.

[www.agilent.com](http://www.agilent.com)  
[www.agilent.com/find/usbsensor](http://www.agilent.com/find/usbsensor)

For more information on Agilent Technologies' products, applications or services, please contact your local Agilent office. The complete list is available at:

[www.agilent.com/find/contactus](http://www.agilent.com/find/contactus)

#### Phone or Fax

##### Americas

Canada	(877) 894-4414
Latin America	305 269 7500
United States	(800) 829-4444

##### Asia Pacific

Australia	1 800 629 485
China	800 810 0189
Hong Kong	800 938 693
India	1 800 112 929
Japan	0120 (421) 345
Korea	080 769 0800
Malaysia	1 800 888 848
Singapore	1 800 375 8100
Taiwan	0800 047 866
Thailand	1 800 226 008

##### Europe & Middle East

Austria	01 36027 71571
Belgium	32 (0) 2 404 93 40
Denmark	45 70 13 15 15
Finland	358 (0) 10 855 2100
France	0825 010 700* *0.125€/minute
Germany	07031 464 6333** **0.14€/minute
Ireland	1890 924 204
Israel	972-3-9288-504/544
Italy	39 02 92 60 8484
Netherlands	31 (0) 20 547 2111
Spain	34 (91) 631 3300
Sweden	0200-88 22 55
Switzerland	0800 80 53 53
United Kingdom	44 (0) 118 9276201

Other European Countries:

[www.agilent.com/find/contactus](http://www.agilent.com/find/contactus)

Revised: October 1, 2008

© Agilent Technologies, Inc. 2008  
Printed in USA, December 9, 2008  
5989-6278EN



**Agilent Technologies**