

# OSRAM GR VJLPL1.23

## Datasheet

Published by **ams-OSRAM AG**

Tobelbader Strasse 30, 8141 Premstaetten, Austria

Phone +43 3136 500-0

[ams-osram.com](http://ams-osram.com)

© All rights reserved



OSLON® Pure 1414

# GR VJLPL1.23

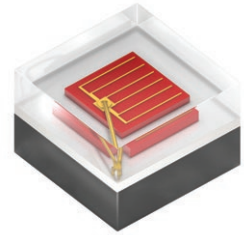

## Applications

- Entertainment
- Indoor Lighting
- Medical Lighting
- Outdoor & Industrial Lighting

## Features

- Package: chip level conversion
- Typ. Radiation: 150°
- ESD: 2 kV acc. to ANSI/ESDA/JEDEC JS-001 (HBM, Class 2)
- Luminous Flux: typ. 85 lm @ 25 °C
- Luminous efficacy: typ. 108 lm/W

---

## Ordering Information

Type	Luminous Flux <sup>1)</sup> $I_F = 350 \text{ mA}$ $\Phi_V$	Ordering Code
GR VJLPL1.23-KQKS-A4R2-1	76.3 ... 97.0 lm	Q65113A7184

---

## Maximum Ratings

Parameter	Symbol		Values
Operating Temperature	$T_{op}$	min.	-40 °C
		max.	100 °C
Storage Temperature	$T_{stg}$	min.	-40 °C
		max.	100 °C
Junction Temperature	$T_j$	max.	135 °C
Forward current	$I_F$	min.	10 mA
		max.	1000 mA
Surge Current $t \leq 10 \mu s$ ; $D = 0.005$ ; $T_j = 25 \text{ °C}$	$I_{FS}$	max.	2000 mA
Reverse voltage <sup>2)</sup>	$V_R$		Not designed for reverse operation
ESD withstand voltage acc. to ANSI/ESDA/JEDEC JS-001 (HBM, Class 2)	$V_{ESD}$		2 kV

## Characteristics

$I_F = 350 \text{ mA}$ ;  $T_J = 25 \text{ °C}$

Parameter	Symbol		Values
Dominant Wavelength <sup>3)</sup> $I_F = 350 \text{ mA}$	$\lambda_{\text{dom}}$	min. max.	610 nm 630 nm
Viewing angle at 50% $I_V$	$2\phi$	typ.	140 °
Forward Voltage <sup>4)</sup> $I_F = 350 \text{ mA}$	$V_F$	min. typ. max.	1.90 V 2.25 V 2.50 V
Reverse current <sup>2)</sup>	$I_R$		Not designed for reverse operation
Electrical thermal resistance junction/solderpoint with efficiency $\eta_e = 49.8 \%$	$R_{\text{thJS elec.}}$	typ.	4.5 K / W

## Brightness Groups

Group	Luminous Flux <sup>1)</sup> $I_F = 350 \text{ mA}$ min. $\Phi_V$	Luminous Flux <sup>1)</sup> $I_F = 350 \text{ mA}$ max. $\Phi_V$
KQ	76.3 lm	82.0 lm
KR	82.0 lm	89.2 lm
KS	89.2 lm	97.0 lm

## Forward Voltage Groups

Group	Forward Voltage <sup>4)</sup> $I_F = 350 \text{ mA}$ min. $V_F$	Forward Voltage <sup>4)</sup> $I_F = 350 \text{ mA}$ max. $V_F$
E2	1.90 V	2.00 V
F1	2.00 V	2.10 V
F2	2.10 V	2.20 V
G1	2.20 V	2.30 V
G2	2.30 V	2.40 V
H1	2.40 V	2.50 V

## Wavelength Groups

Group	Dominant Wavelength <sup>3)</sup> $I_F = 350 \text{ mA}$ min. $\lambda_{\text{dom}}$	Dominant Wavelength <sup>3)</sup> $I_F = 350 \text{ mA}$ max. $\lambda_{\text{dom}}$
A4	610 nm	615 nm
A5	615 nm	620 nm
R1	620 nm	625 nm
R2	625 nm	630 nm

---

## Group Name on Label

**Example: KQ-A4-E2**

Brightness	Wavelength	Forward Voltage
KQ	A4	E2

---

### Relative Spectral Emission <sup>5)</sup>

$I_{rel} = f(\lambda)$ ;  $I_F = 350 \text{ mA}$ ;  $T_J = 25 \text{ }^\circ\text{C}$

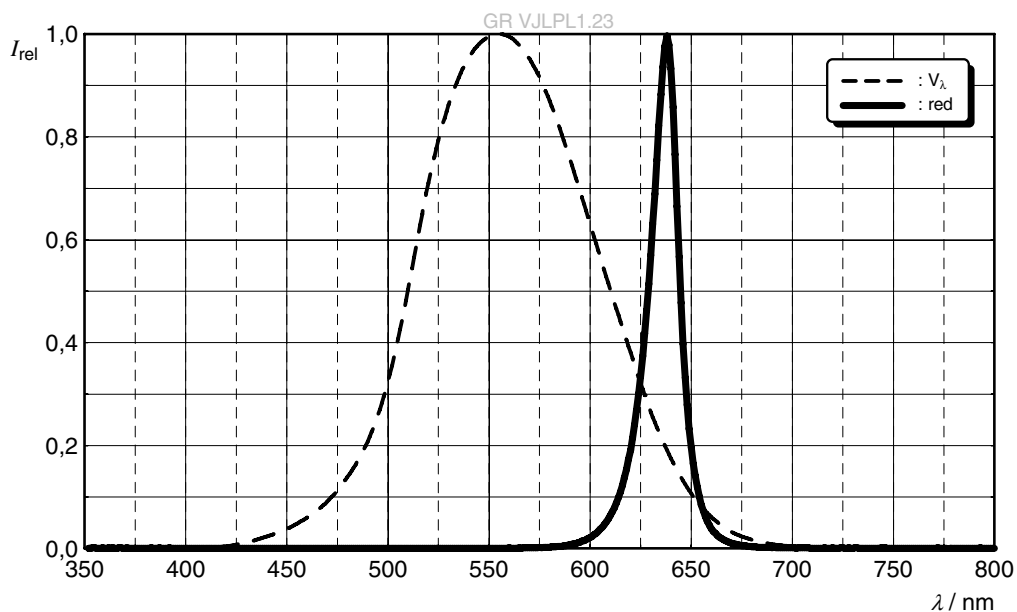

### Radiation Characteristics <sup>5)</sup>

$I_{rel} = f(\phi)$ ;  $T_J = 25 \text{ }^\circ\text{C}$

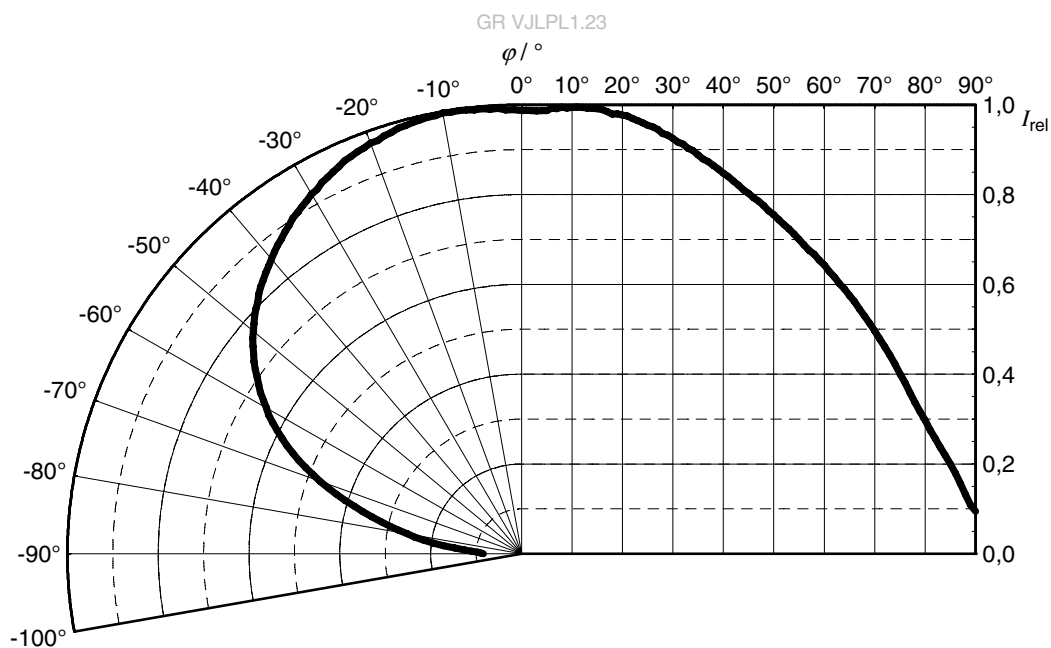



### Forward current <sup>5)</sup>

$$I_F = f(V_F); T_J = 25\text{ °C}$$

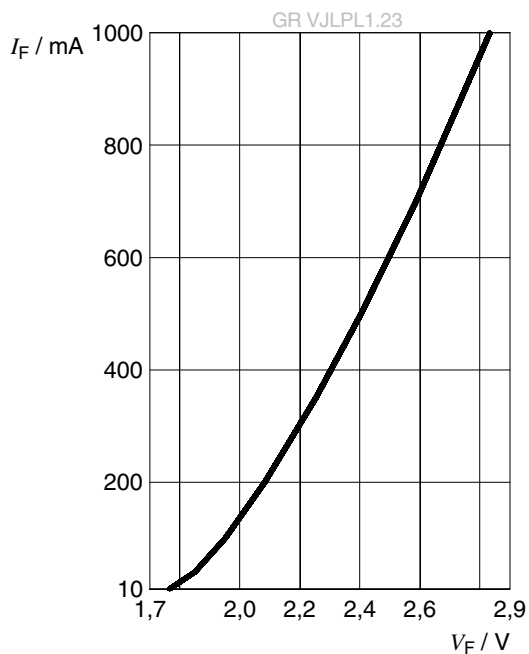

### Relative Luminous Flux <sup>5), 6)</sup>

$$\Phi_V / \Phi_V(350\text{ mA}) = f(I_F); T_J = 25\text{ °C}$$

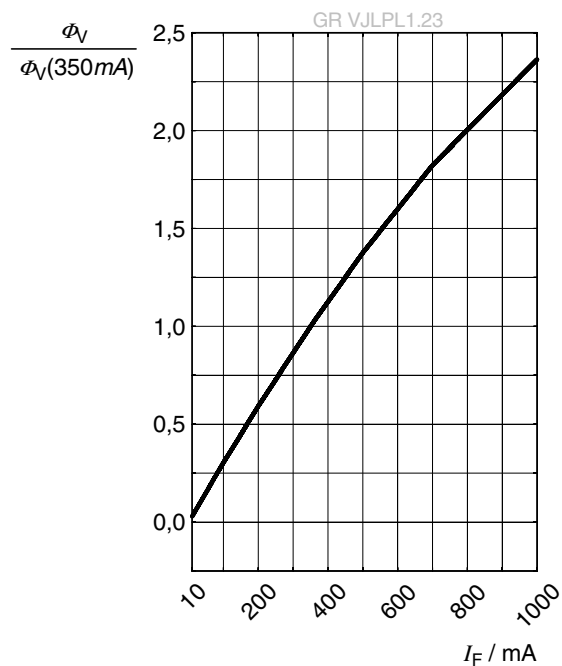

### Dominant Wavelength <sup>5)</sup>

$$\Delta\lambda_{\text{dom}} = f(I_F); T_J = 25\text{ °C}$$

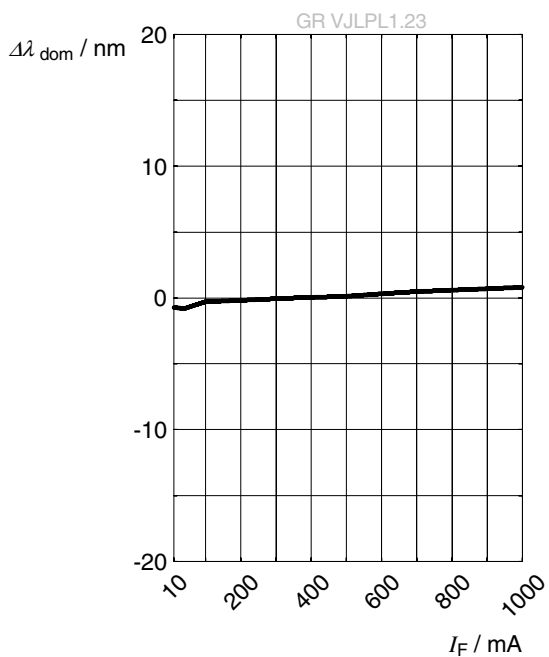

### Forward Voltage <sup>5)</sup>

$$\Delta V_F = V_F - V_F(25\text{ °C}) = f(T_j); I_F = 350\text{ mA}$$

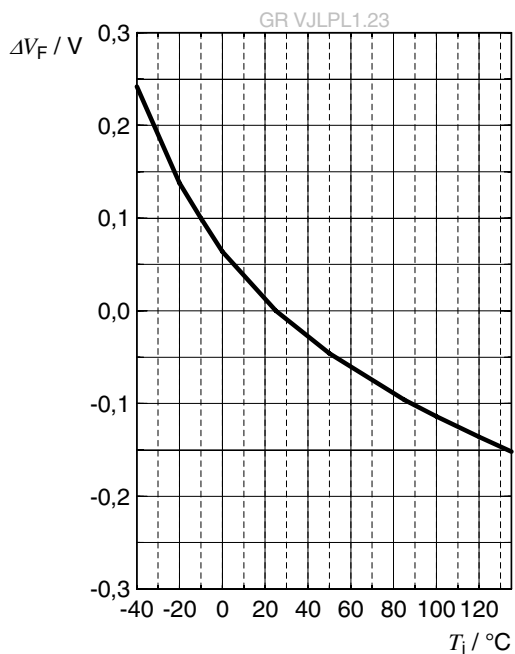

### Relative Luminous Flux <sup>5)</sup>

$$\Phi_V / \Phi_V(25\text{ °C}) = f(T_j); I_F = 350\text{ mA}$$

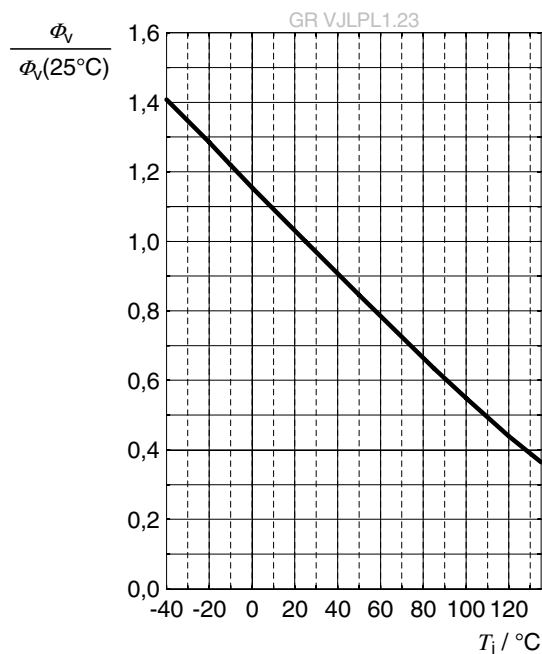

### Dominant Wavelength <sup>5)</sup>

$$\Delta \lambda_{\text{dom}} = \lambda_{\text{dom}} - \lambda_{\text{dom}}(25\text{ °C}) = f(T_j); I_F = 350\text{ mA}$$

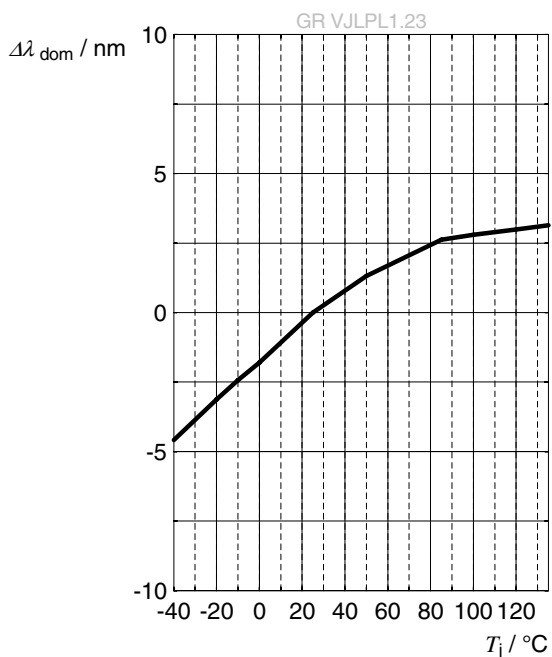

### Max. Permissible Forward Current <sup>7)</sup>

$I_F = f(T)$

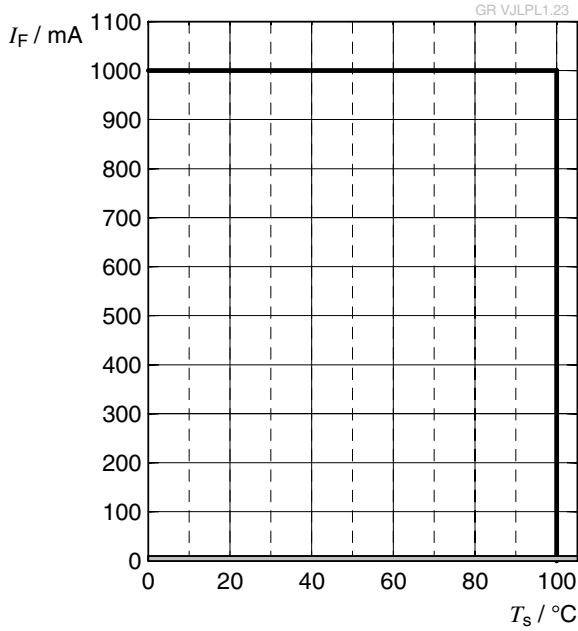

### Permissible Pulse Handling Capability

$I_F = f(t_p)$ ; duty cycle  $D =$  parameter;  $T_s = 25^\circ\text{C}$

GR VJLPL1.23

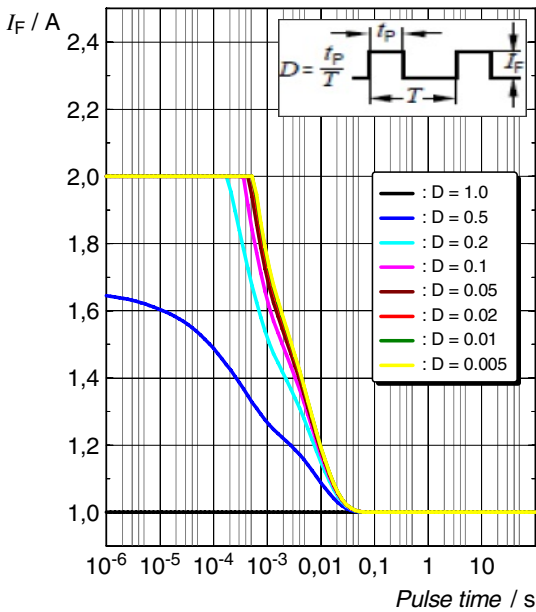

### Permissible Pulse Handling Capability

$I_F = f(t_p)$ ; duty cycle  $D =$  parameter;  $T_s = 100^\circ\text{C}$

GR VJLPL1.23

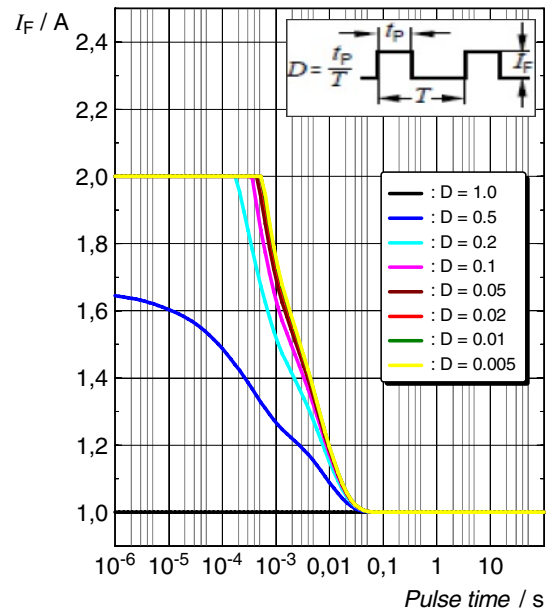

## Dimensional Drawing <sup>8)</sup>

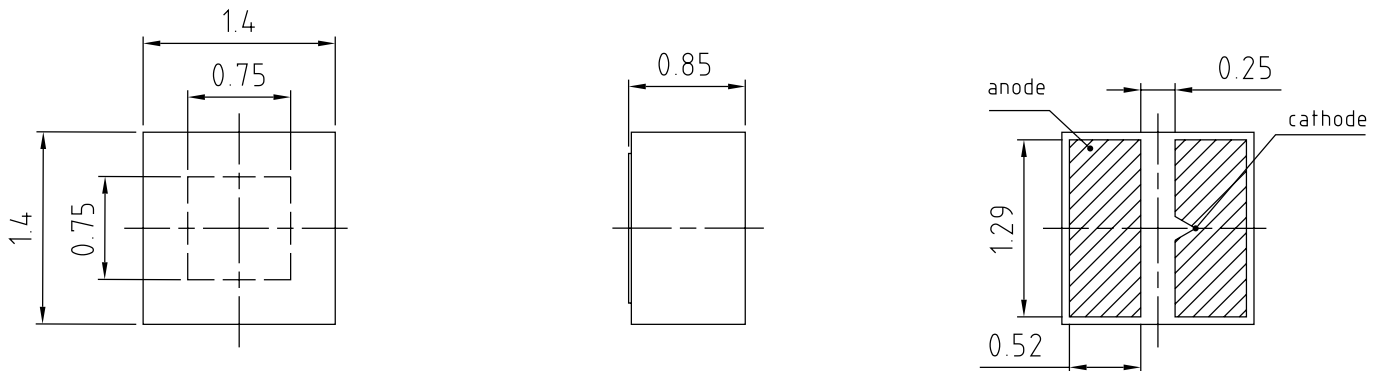

general tolerance  $\pm 0.1$

lead finish Au 

C67062-A0479-A4-01

## Further Information:

**Approximate Weight:** 5.0 mg

**Package marking:** Cathode

Recommended Solder Pad <sup>8)</sup>

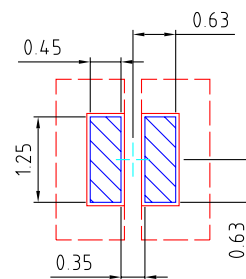
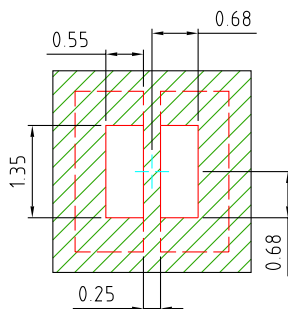
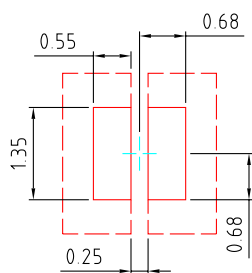

 foot print     Cu area optional

 solder resist

 solder stencil

E067.0346.25-01

For superior solder joint connectivity results we recommend soldering under standard nitrogen atmosphere. further information can be found in our Application Note : "Handling and Processing Details for Ceramic LEDs". Package not suitable for any kind of wet cleaning or ultrasonic cleaning.

## Reflow Soldering Profile

Product complies to MSL Level 2 acc. to JEDEC J-STD-020E

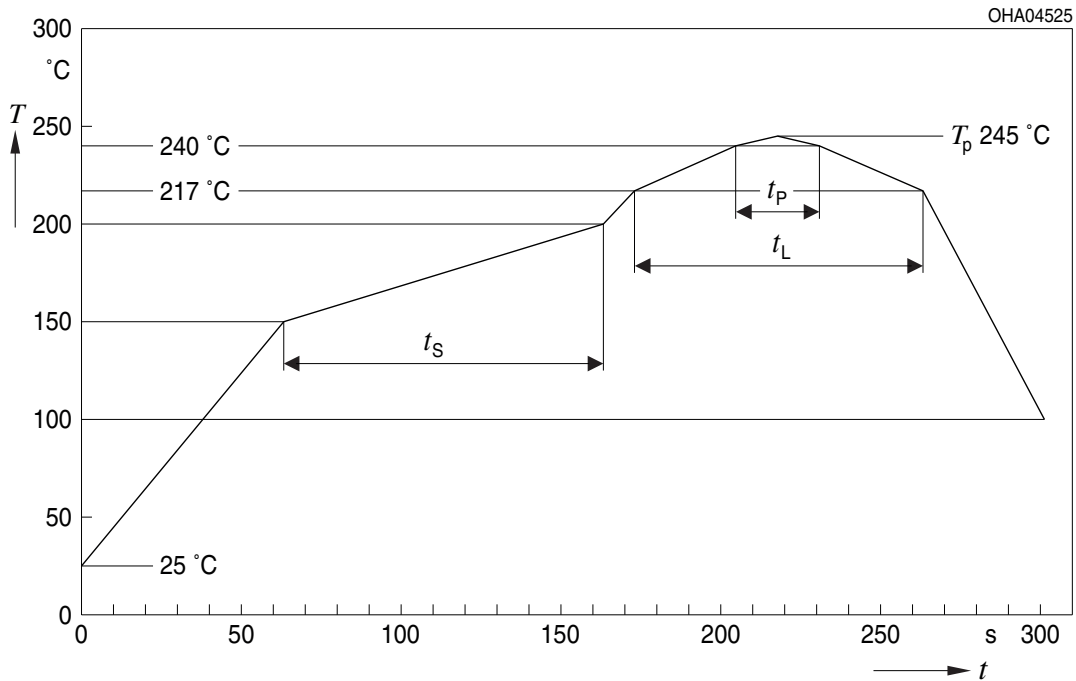

Profile Feature	Symbol	Pb-Free (SnAgCu) Assembly			Unit
		Minimum	Recommendation	Maximum	
Ramp-up rate to preheat <sup>*)</sup> 25 °C to 150 °C			2	3	K/s
Time $t_s$ $T_{Smin}$ to $T_{Smax}$	$t_s$	60	100	120	s
Ramp-up rate to peak <sup>*)</sup> $T_{Smax}$ to $T_p$			2	3	K/s
Liquidus temperature	$T_L$		217		°C
Time above liquidus temperature	$t_L$		80	100	s
Peak temperature	$T_p$		245	260	°C
Time within 5 °C of the specified peak temperature $T_p - 5$ K	$t_p$	10	20	30	s
Ramp-down rate* $T_p$ to 100 °C			3	6	K/s
Time 25 °C to $T_p$				480	s

All temperatures refer to the center of the package, measured on the top of the component

\* slope calculation  $DT/Dt$ :  $Dt$  max. 5 s; fulfillment for the whole T-range

Taping <sup>8)</sup>

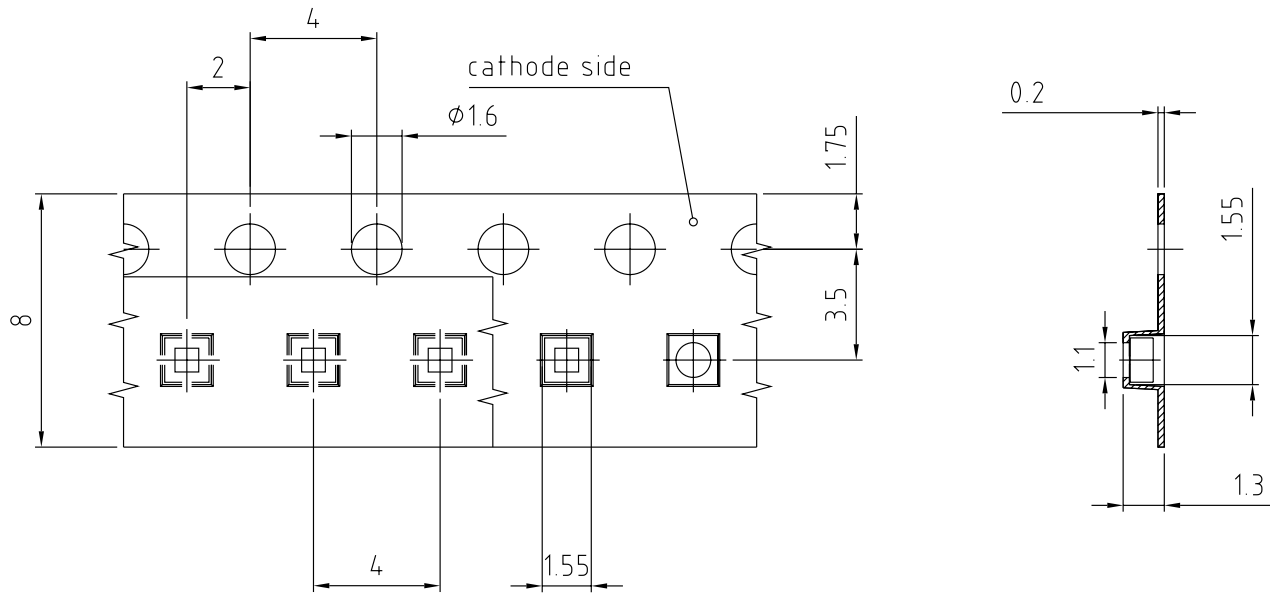

C67062-A0479-B4-01

**Tape and Reel** <sup>9)</sup>

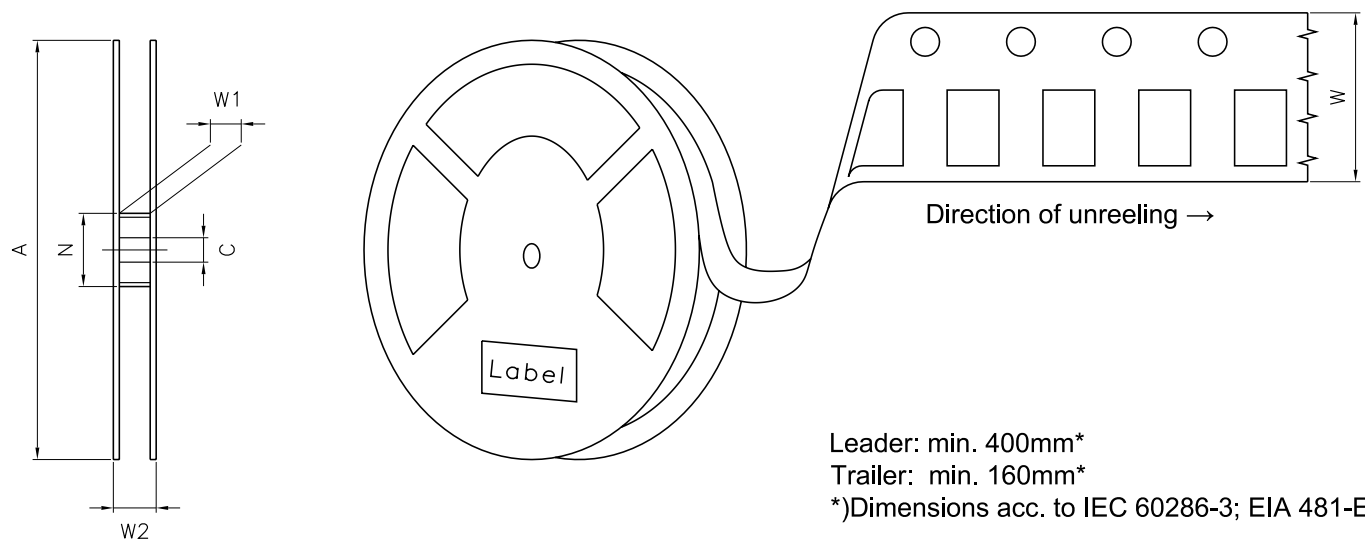

**Reel Dimensions**

A	W	N <sub>min</sub>	W <sub>1</sub>	W <sub>2 max</sub>	Pieces per PU
180 mm	8 + 0.3 / - 0.1 mm	60 mm	8.4 + 2 mm	14.4 mm	1000



### Barcode-Product-Label (BPL)

**OSRAM** LX XXXX BIN1: XX-XX-X-XXX-X

RoHS Compliant



(6P) BATCH NO: 1234567890

(1T) LOT NO: 1234567890 (9D) D/C: 1234

(X) PROD NO: 123456789 (Q) QTY: 9999 (G) GROUP: XX-XX-X-X

ML Temp ST  
X XXX °C X

Pack: RXX  
DEMY XXX  
X\_X123\_1234.1234 X



OHA04563

### Dry Packing Process and Materials



OHA00539

Moisture-sensitive product is packed in a dry bag containing desiccant and a humidity card according JEDEC-STD-033.

---

## Notes

The evaluation of eye safety occurs according to the standard IEC 62471:2006 (photo biological safety of lamps and lamp systems). Within the risk grouping system of this IEC standard, the device specified in this data sheet fall into the class **exempt group (exposure time 10000 s)**. Under real circumstances (for exposure time, conditions of the eye pupils, observation distance), it is assumed that no endangerment to the eye exists from these devices. As a matter of principle, however, it should be mentioned that intense light sources have a high secondary exposure potential due to their blinding effect. When looking at bright light sources (e.g. headlights), temporary reduction in visual acuity and afterimages can occur, leading to irritation, annoyance, visual impairment, and even accidents, depending on the situation.

Subcomponents of this device contain, in addition to other substances, metal filled materials including silver. Metal filled materials can be affected by environments that contain traces of aggressive substances. Therefore, we recommend that customers minimize device exposure to aggressive substances during storage, production, and use. Devices that showed visible discoloration when tested using the described tests above did show no performance deviations within failure limits during the stated test duration. Respective failure limits are described in the IEC60810.

This device is designed for specific/recommended applications only. Please consult OSRAM Opto Semiconductors Sales Staff in advance for detailed information on other non-recommended applications (e.g. automotive).

Change management for this component is aligned with the requirements of the lighting market.

For further application related information please visit <https://ams-osram.com/support/application-notes>

## Disclaimer

### Attention please!

The information describes the type of component and shall not be considered as assured characteristics. Terms of delivery and rights to change design reserved. Due to technical requirements components may contain dangerous substances.

For information on the types in question please contact our Sales Organization.

If printed or downloaded, please find the latest version on our website.

### Packing

Please use the recycling operators known to you. We can also help you – get in touch with your nearest sales office. By agreement we will take packing material back, if it is sorted. You must bear the costs of transport. For packing material that is returned to us unsorted or which we are not obliged to accept, we shall have to invoice you for any costs incurred.

### Product and functional safety devices/applications or medical devices/applications

Our components are not developed, constructed or tested for the application as safety relevant component or for the application in medical devices.

Our products are not qualified at module and system level for such application.

In case buyer – or customer supplied by buyer – considers using our components in product safety devices/ applications or medical devices/applications, buyer and/or customer has to inform our local sales partner immediately and we and buyer and /or customer will analyze and coordinate the customer-specific request between us and buyer and/or customer.

---

## Glossary

- 1) **Brightness:** Brightness values are measured during a current pulse of typically 10 ms, with a tolerance of +/- 7%.
- 2) **Reverse Operation:** Not designed for reverse operation. Continuous reverse operation can cause migration and damage of the device.
- 3) **Wavelength:** The wavelength is measured at a current pulse of typically 10 ms, with a tolerance of  $\pm 0.5$  nm.
- 4) **Forward Voltage:** The Forward voltage is measured during a current pulse duration of typically 1 ms with a tolerance of  $\pm 0.05V$ .
- 5) **Typical Values:** Due to the special conditions of the manufacturing processes of semiconductor devices, the typical data or calculated correlations of technical parameters can only reflect statistical figures. These do not necessarily correspond to the actual parameters of each single product, which could differ from the typical data and calculated correlations or the typical characteristic line. If requested, e.g. because of technical improvements, these typ. data will be changed without any further notice.
- 6) **Characteristic curve:** In the range where the line of the graph is broken, you must expect higher differences between single devices within one packing unit.
- 7) **Thermal Resistance:**  $R_{th\ max}$  is based on statistic values ( $6\sigma$ ) used for Derating.
- 8) **Tolerance of Measure:** Unless otherwise noted in drawing, tolerances are specified with  $\pm 0.1$  and dimensions are specified in mm.
- 9) **Tape and Reel:** All dimensions and tolerances are specified acc. IEC 60286-3 and specified in mm.

---

## Revision History

Version	Date	Change
1.0	2023-11-09	Initial Version

---



EU RoHS and China RoHS compliant product

此产品符合欧盟 RoHS 指令的要求；  
按照中国的相关法规和标准，  
不含有毒有害物质或元素。

**Published by ams-OSRAM AG**

Tobelbader Strasse 30, 8141 Premstaetten, Austria

Phone +43 3136 500-0

[ams-osram.com](http://ams-osram.com)

© All rights reserved

**am** 

**OSRAM**