

# NGRM1204US0R915G1TRF

## 915 MHz ISM FR4 Chip Antenna



### Features

- Stable and reliable performance
- Supports ISM 915 MHz Band
- FR4 Material: Monopole
- Low Profile, Compact Size
- RoHs Complaint

### Applications

- Short Range Devices (SRD)
- IoT Applications
- Alarm Systems

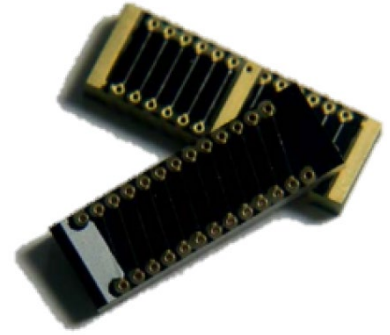

### Specifications

Electrical	
Frequency Range	902~928 MHz
VSWR	2 Max.
Average Gain	-5.2 dB Typ.
Peak Gain	-0.1 dBi Typ.
Efficiency	30.1 % Typ.
Maximum Input Power	2 W
Polarization	Linear
Impedance	50Ω
Environmental	
Operating Temperature	-40°C~+85°C
Storage Temperature	-5°C~+40°C -40°C~+85°C - After mounting on PCB
Relative Humidity	10% to 70% - Operating & Storage after mounting on PCB 20% to 70% - Storage
Shelf Life	1 year
RoHs Compliant	Yes

# NGRM1204US0R915G1TRF

915 MHz ISM FR4 Chip Antenna



## Part Number Breakdown

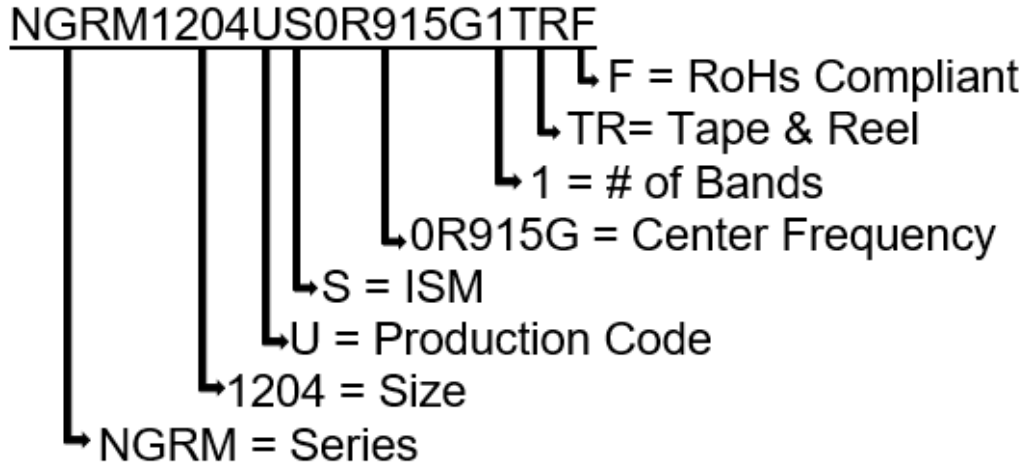

## Pin Definition



PIN	1	2~3
Soldering Pad	Signal	N/C

### Dimension Drawing

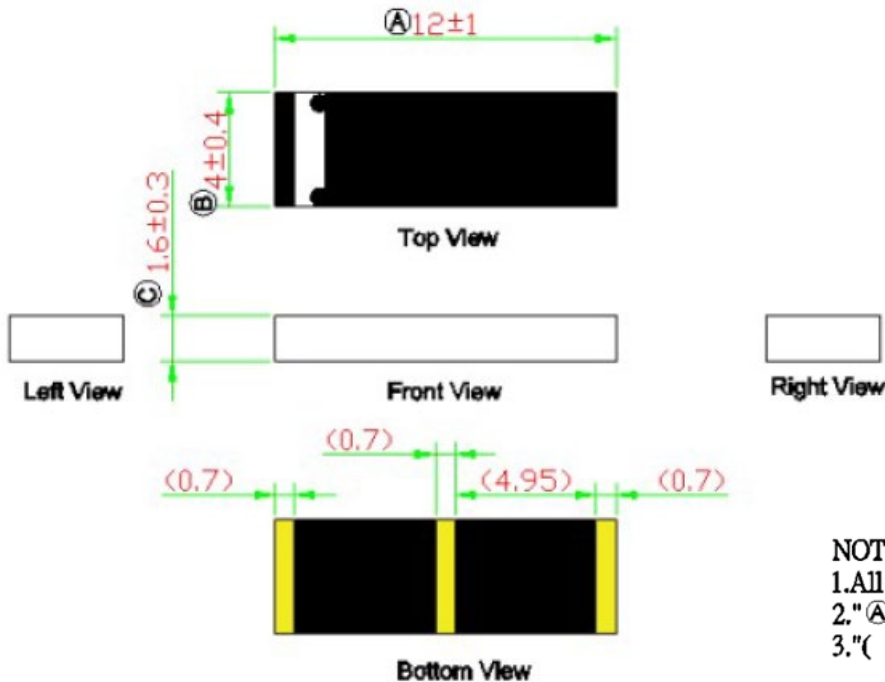

**NOTE:**  
 1. All materials are RoHS 2.0 compliant.  
 2. "A~C" Critical Dimensions.  
 3. "( )" Reference Dimensions.

### Dimensions (mm) & Mechanical

Body Length (A)	12 ± 1
Width (B)	4 ± 0.4
Thickness (C)	1.6 ± 0.3
Connection Type	SMT
Ground Plane	80 mm x 40 mm
Material	FR4

# NGRM1204US0R915G1TRF

915 MHz ISM FR4 Chip Antenna



## Evaluation Board

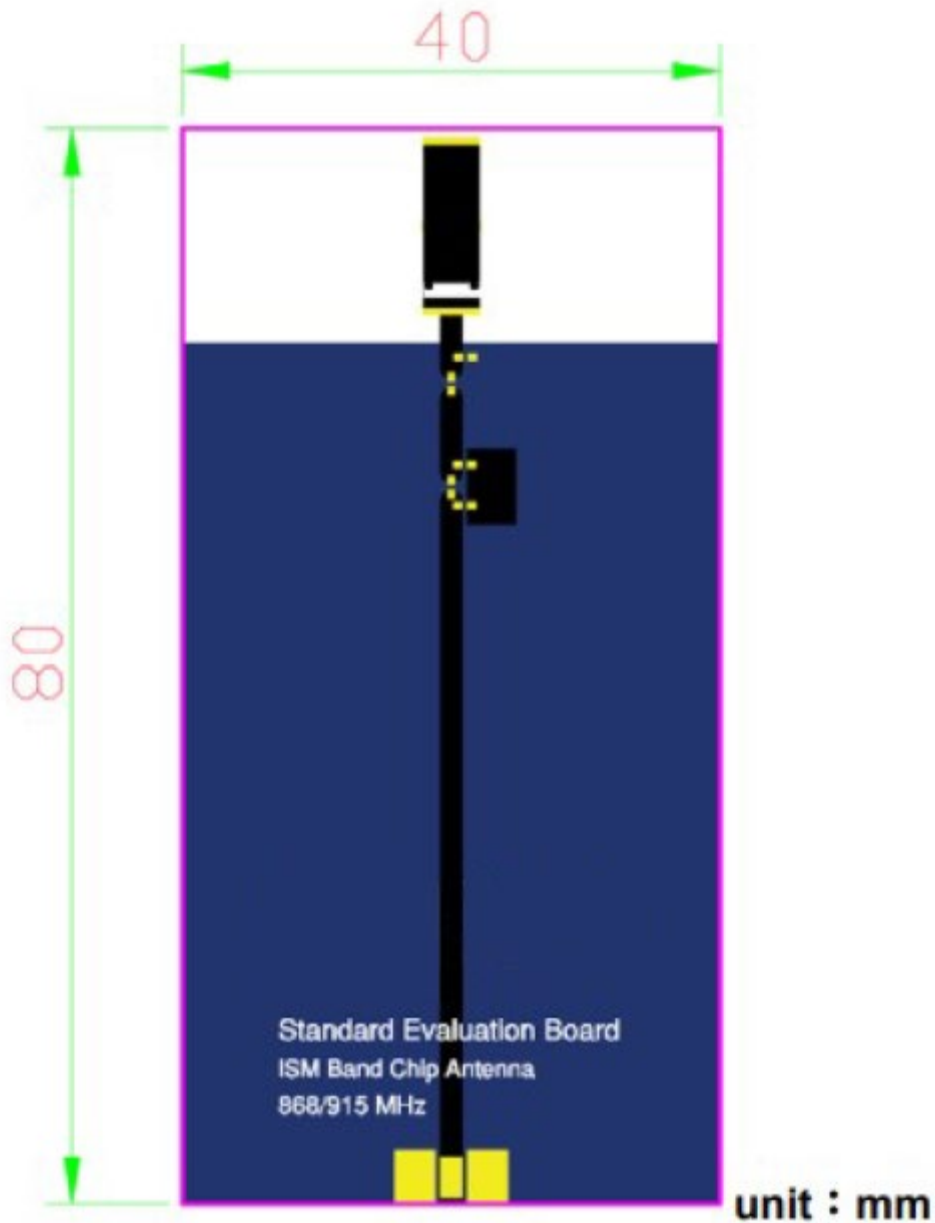

# NGRM1204US0R915G1TRF

915 MHz ISM FR4 Chip Antenna



## Solder Land Pattern

The gold areas represent the solder land pattern. Any recommendations on the matching circuit will be provided according to the customer's installation conditions.

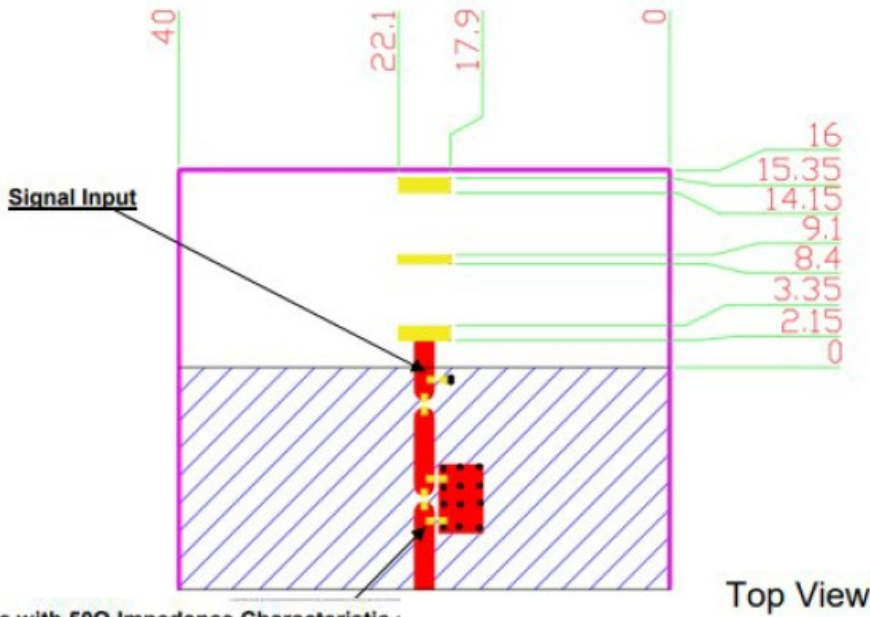

Top View

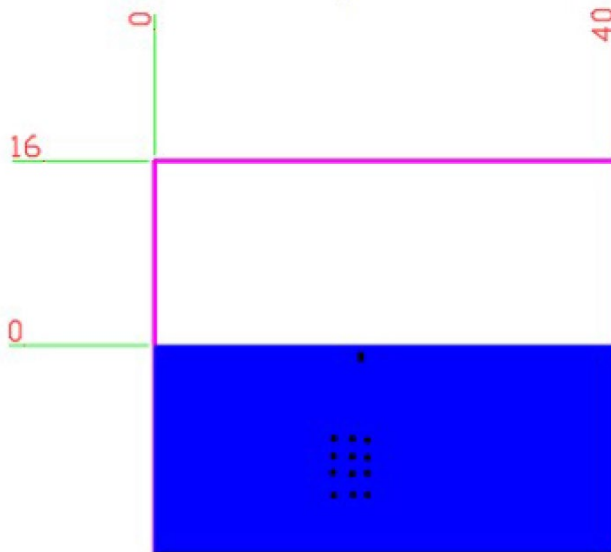

Bottom View

### Soldering Conditions

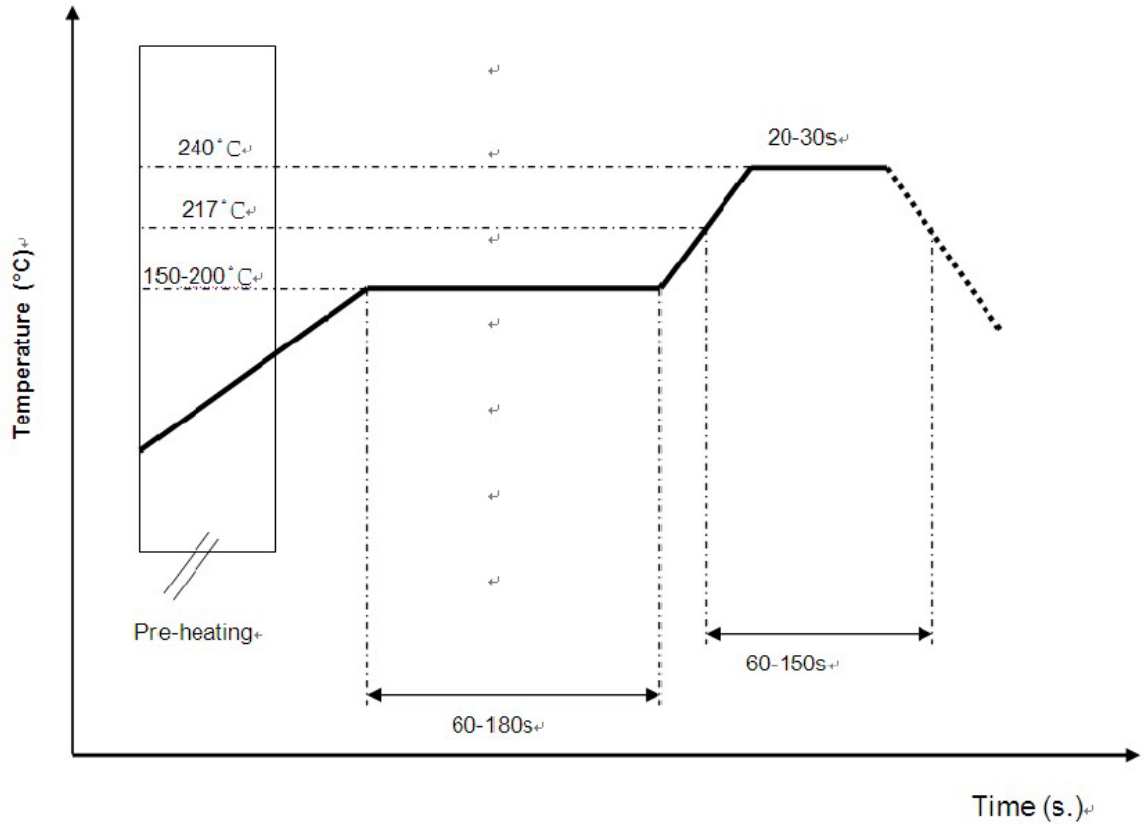

\*Recommended solder paste alloy: SAC305 (Sn96.5 /Ag3 /Cu0.5) Lead Free solder paste.



### Return loss (dB)

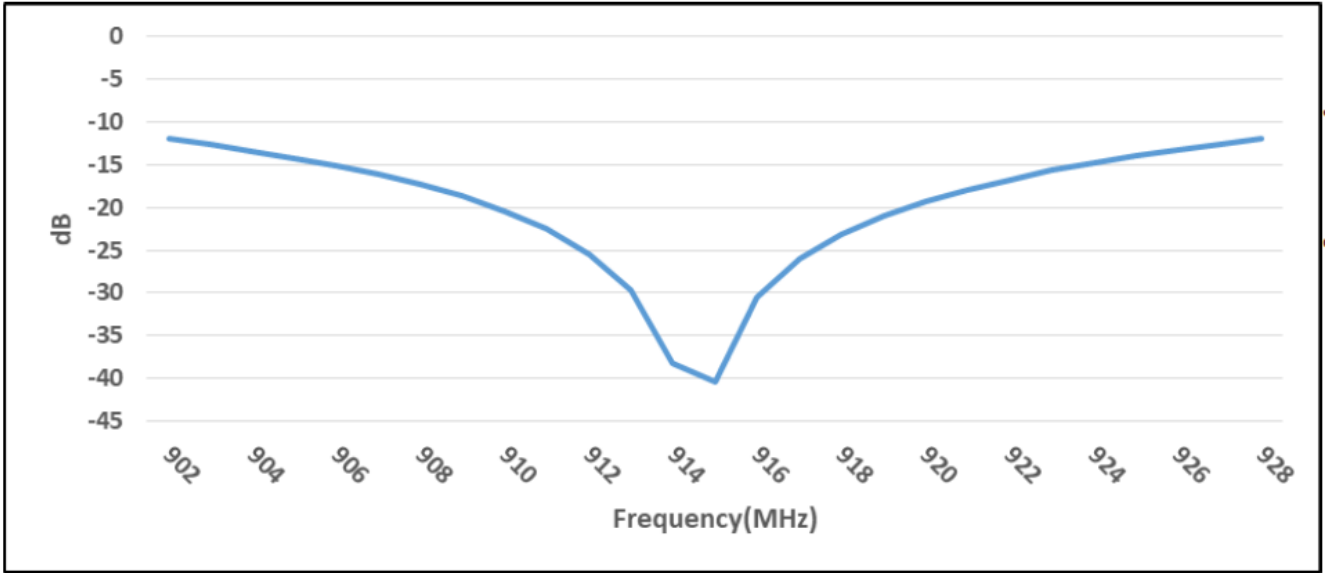

### Efficiency (%)

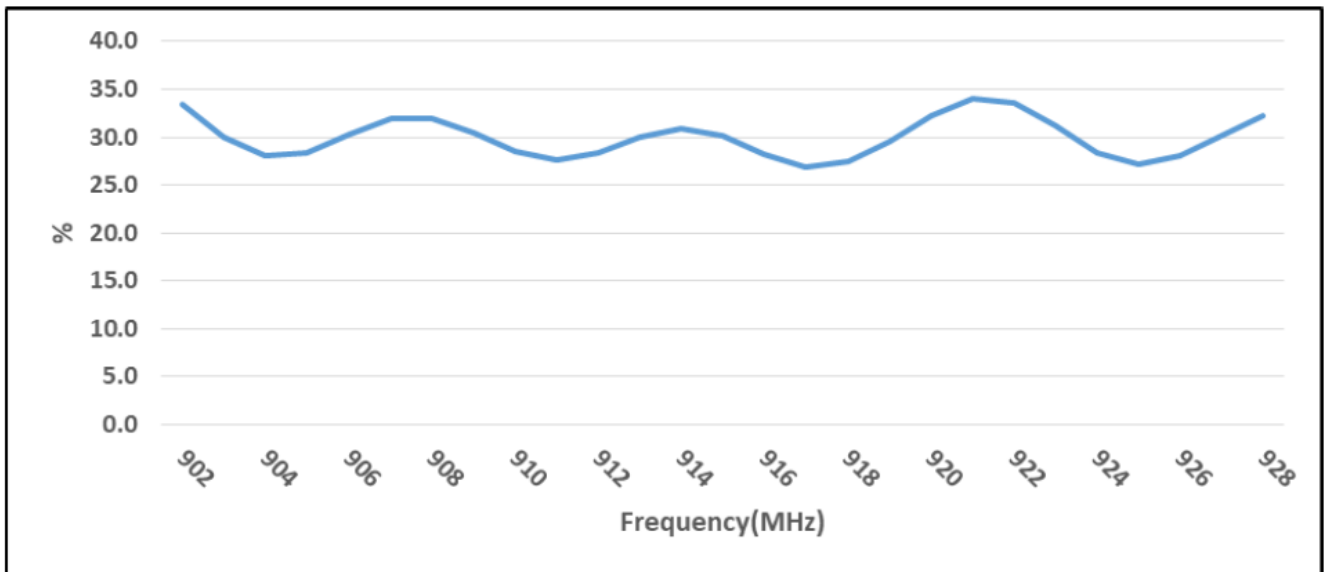



### Average Gain (dB)

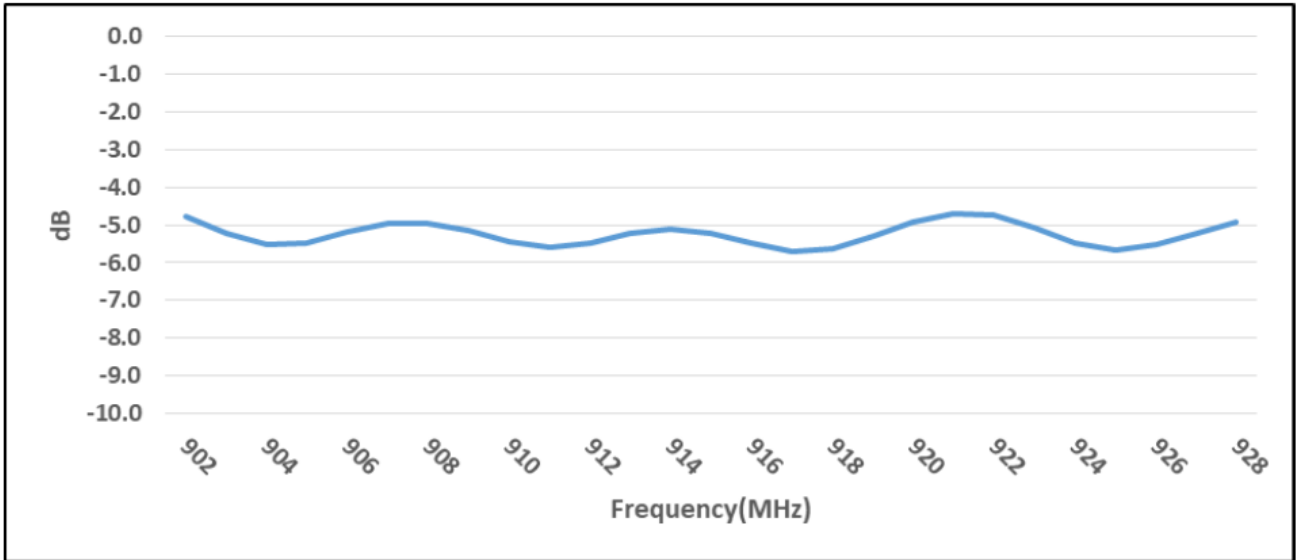

### Peak Gain (dBi)

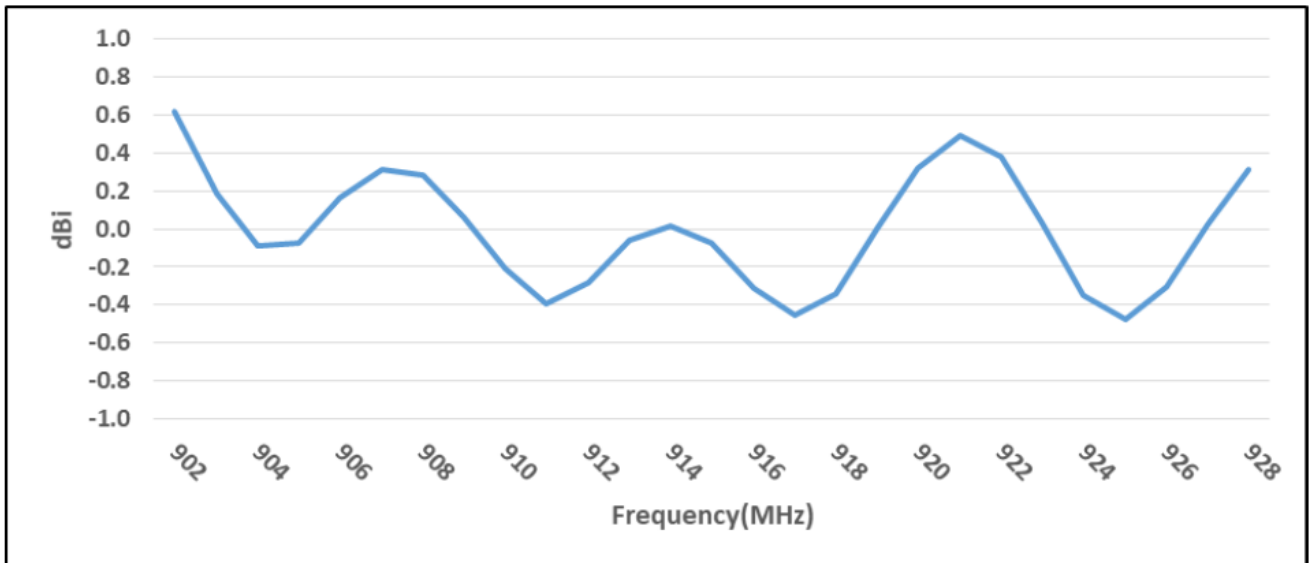



### Antenna Radiation Pattern Measurement:

The antenna radiation patterns are measured in a 3D Anechoic Chamber. The measurement setup is as show below.

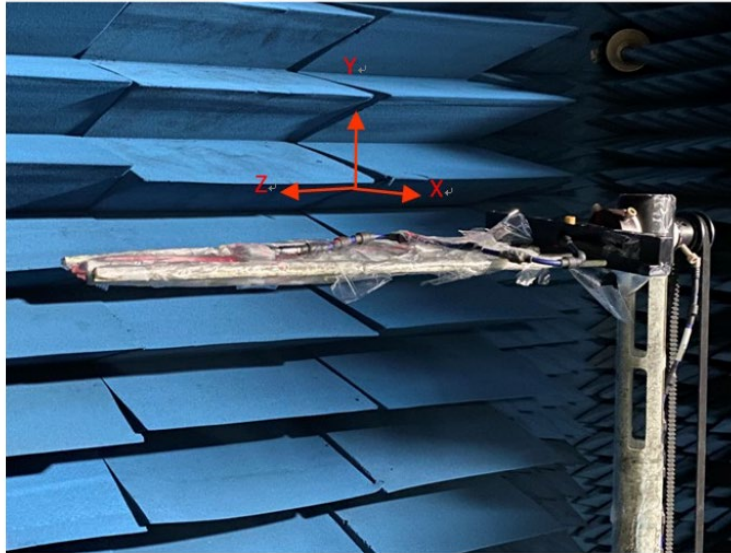

### 3D Radiation Gain Pattern

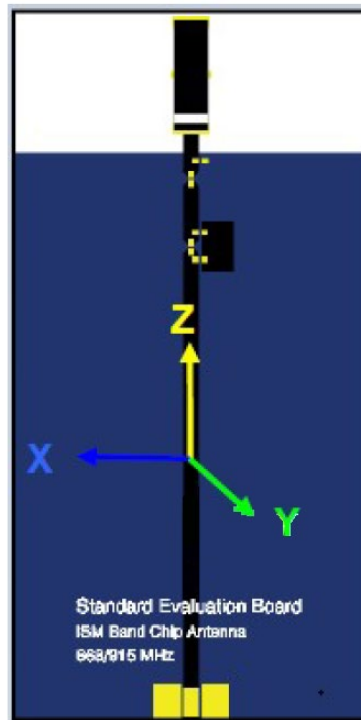

# NGRM1204US0R915G1TRF

915 MHz ISM FR4 Chip Antenna



## 915 MHz (unit: dBi)

Total\_3D\_H\_915MHz

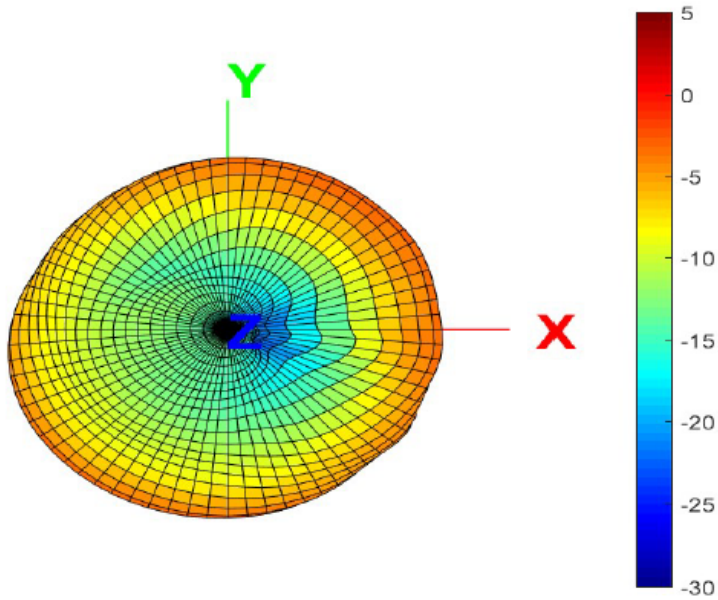

Total\_3D\_Front View\_915MHz

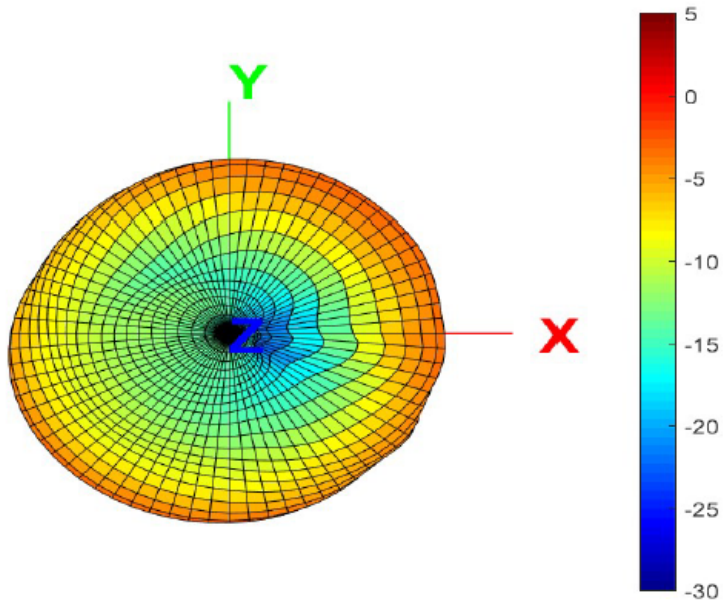

# NGRM1204US0R915G1TRF

915 MHz ISM FR4 Chip Antenna



Total\_3D\_E1\_915MHz

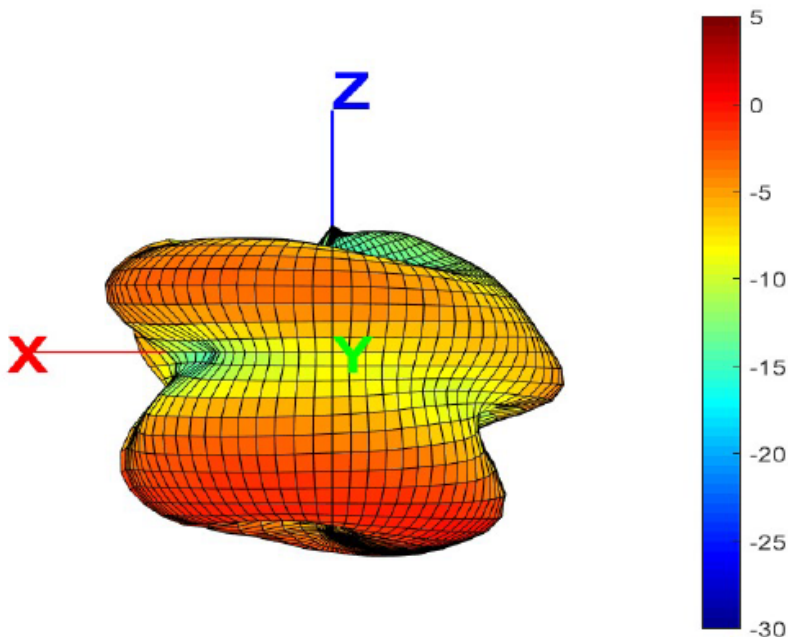

### Frequency Tuning & Matching Circuit

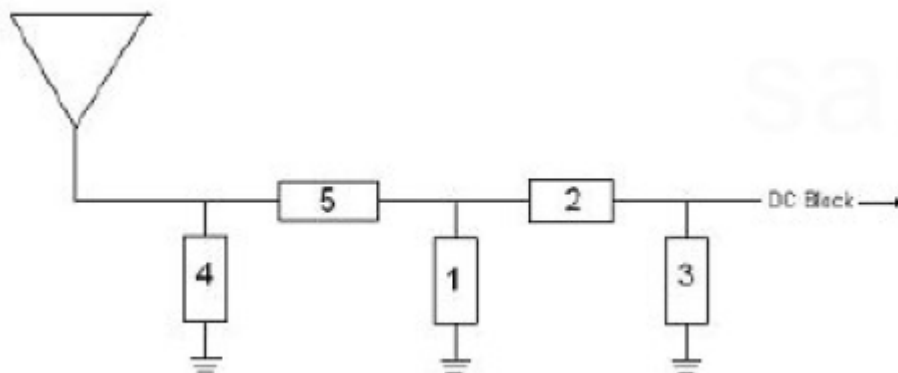
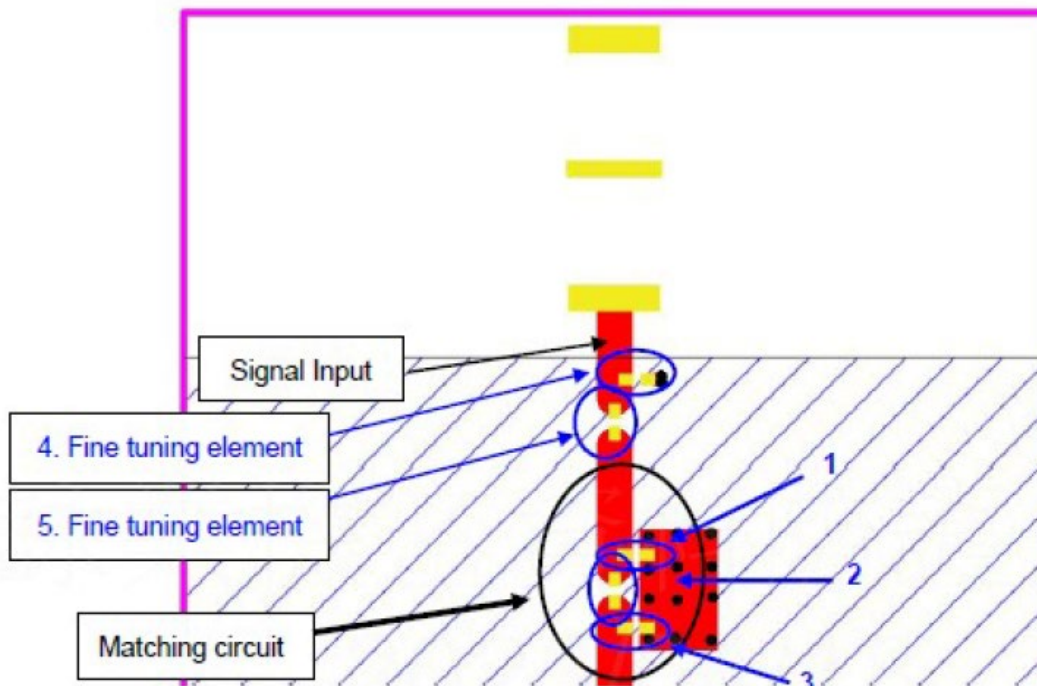



### System Matching Circuit Component

Location	Description	Tolerance	NIC Part Number
1	6.8nH, (0402)	±3%	<a href="#">NMLQ04H6N8TRF</a>
2	1.5nH, (0402)	±0.1nH	<a href="#">NMLQ04B1N5TRF</a>
3	N/A	-	
4 Fine Tuning Elements	0.4pF, (0402)	±0.05nH	<a href="#">NMC-Q0402NPO0R4A50TRPF</a>
5 Fine Tuning Elements	1.5nH, (0402)	±0.1nH	<a href="#">NMLQ04B1N5TRF</a>

### Packing

- (1) Quantity/Reel: 3500 pcs/Reel
- (2) Plastic tape: Black Conductive Polystyrene.

a. Tape Drawing

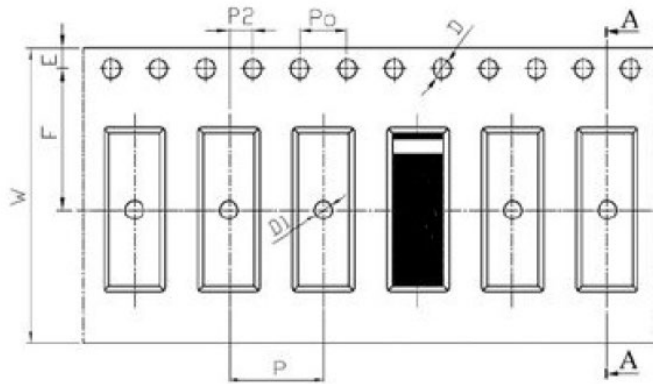

b. Tape Dimensions (unit: mm)

Feature	Specifications	Tolerances
W	24.00	±0.30
P	8.00	±0.10
E	1.75	±0.10
F	11.50	±0.10
P2	2.00	±0.10
D	1.50	+0.10 -0.00
D1	1.50	±0.10
Po	4.00	±0.10
10Po	40.00	±0.20