

USER MANUAL

ORTHOSIE-I

2617011022000

VERSION 1.0

MAY 3, 2024

WÜRTH ELEKTRONIK MORE THAN YOU EXPECT

Revision history

Manual version	HW version	Notes	Date
1.0	4.0	<ul style="list-style-type: none">• Initial version	May 2024

Abbreviations

Abbreviation	Name	Description
BYOF	Build Your Own Firmware	Radio module without firmware to develop custom firmware
EV (Board)	Evaluation (Board)	Orthosie-I populated on motherboard with USB interface for test and evaluation purposes.
MCU	MicroController Unit	
RF	Radio Frequency	Describes everything relating to the wireless transmission.
SDK	Software Development Kit	Set of tools for third-party developers to use in producing applications using a particular framework or platform.
UART	Universal Asynchronous Receiver Transmitter	Protocol for the exchange of data in series between two devices.
VDD	Supply voltage	

Contents

Overview of helpful application notes	5
1 Introduction	6
1.1 Operational description	6
1.2 Block diagram	7
1.3 Ordering information	7
2 Electrical specifications	8
2.1 Recommended operating conditions	8
2.2 Absolute maximum ratings	8
2.3 Power consumption	8
2.3.1 Static	8
2.4 Radio characteristics	9
2.5 Pin characteristics	9
3 Pinout	10
4 Radio power settings	12
5 Design in guide	13
5.1 Advice for schematic and layout	13
6 Reference design	16
6.1 EV-Board	17
6.2 Layout	19
6.3 Flashing or erasing of the chipset	21
7 Manufacturing information	23
7.1 Moisture sensitivity level	23
7.2 Soldering	23
7.2.1 Reflow soldering	23
7.2.2 Cleaning	24
7.2.3 Potting and coating	25
7.2.4 Other notations	25
7.3 ESD handling	25
7.4 Safety recommendations	26
8 Physical specifications	27
8.1 Dimensions	27
8.2 Weight	27
8.3 Module drawing	28
8.4 Footprint	29
8.5 Antenna free area	29
9 Marking	30
9.1 Lot number	30
9.2 General labeling information	31

10 Information for explosion protection	32
11 Bluetooth SIG listing/qualification	33
12 References	34
13 Important notes	35
14 Legal notice	35
15 License terms	36

Overview of helpful application notes

Application note ANR010 - Range estimation

<http://www.we-online.com/ANR010>

This application note presents the two most used mathematical range estimation models, Friis and two ray ground reflection, and its implementation in the range estimation tool of the RED-EXPERT.

Application note ANR027 - Bluetooth listing guide

<http://www.we-online.com/ANR027>

Every product containing Bluetooth® technology needs to be listed at the Bluetooth® SIG (special interest group). This application note explains the steps to be done to gain a Bluetooth® listing for the end product using a Würth Elektronik eiSos Bluetooth® LE radio module.

Application note ANR031 - Certification of custom modules

<http://www.we-online.com/ANR031>

This application note explains how certifications of a standard product can be used to gain the certification of a customized product. This is done for firmware, that has been adapted by Würth Elektronik eiSos, as well as for firmware written by customer.

1 Introduction

1.1 Operational description

The Orthosie-I module is a radio module/device for wireless communication between devices such as control systems, remote controls, sensors etc.



Be aware that the Orthosie-I module contains a test firmware version exclusively used for our production process.

The user has the complete freedom to develop his own application based on the Espressif SDKs [1] (e.g. Bluetooth® LE, WiFi, Matter). To fulfil the needs and specifications of such applications, a tailored firmware can be developed, based on the Orthosie-I hardware. This includes the connection and communication to custom sensors, custom Bluetooth® LE profiles, timing configurations, security configurations as well as power consumption optimizations. Even with its small dimensions of 9.5 mm x 13 mm, Orthosie-I provides a strongly miniaturized integrated PCB antenna.

The main functionality is accessible through pads underneath the radio module.



The Orthosie-I shares the same hardware platform as the Stephano-I module. For this reason, Stephano-I is often referred to in this user manual.



Figure 1: Orthosie-I

1.2 Block diagram

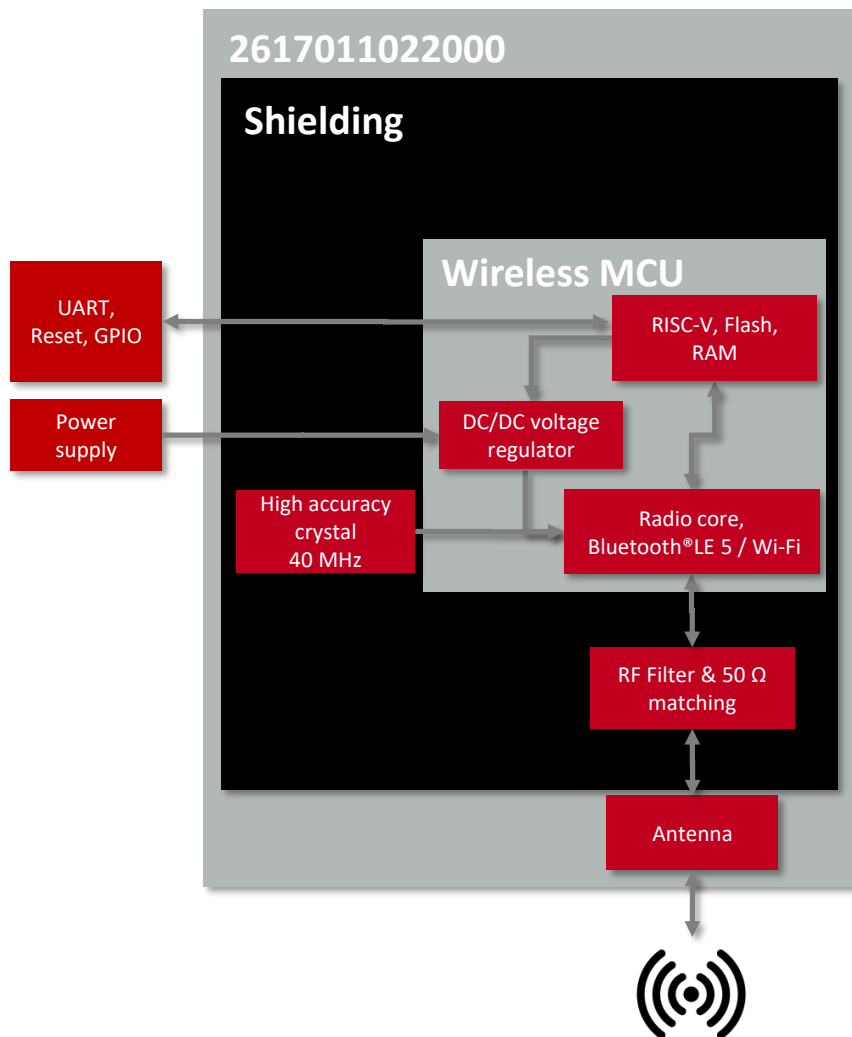

Figure 2: Block diagram

1.3 Ordering information

WE order code	Description
2617011022000	Orthosie-I BYOF module with integrated PCB antenna, Tape & Reel
2617029022001	Evaluation board with Orthosie-I module mounted

Table 1: Ordering information

2 Electrical specifications

If not otherwise stated, measured on the Orthosie-I evaluation board with $T = 25\text{ °C}$, $V_{DD} = 3.3\text{ V}$.

2.1 Recommended operating conditions

Description	Min.	Typ.	Max.	Unit
VDD	3.0	3.3	3.6	V
Temperature range	-40		85	°C

Table 2: Recommended operating conditions

2.2 Absolute maximum ratings

Description	Min.	Typ.	Max.	Unit
VDD	-0.3		3.6	V

Table 3: Absolute maximum ratings

2.3 Power consumption

2.3.1 Static

Description	Test condition	Min.	Typ.	Max.	Unit
WiFi TX current consumption at max output power	Mode: WiFi 11b, Data rate: 1 Mbps, Power index: 80		167		mA
WiFi RX current consumption			82		mA
Bluetooth® LE TX current consumption at max output power	Mode: Bluetooth® LE, Data rate: 1 Mbps, Power index: 12		161		mA
Bluetooth® LE RX current consumption			81		mA
Deep-sleep mode		5			µA
System-off mode (/RESET set to GND)		1			µA

Table 4: Power consumption

2.4 Radio characteristics

Description	Test condition	Min.	Typ.	Max.	Unit
Max output power ¹	Data rate: 1 Mbps, Power index: 80		13.4		dBm
Input sensitivity	Data rate: 1 Mbps		-87		dBm
Frequencies		2412		2484	MHz

Table 5: WiFi radio characteristics (radiated)

Description	Test condition	Min	Typ.	Max	Unit
Max output power ¹	Data rate: 1 Mbps, Power index: 12		4.5		dBm
Input sensitivity	Data rate: 1 Mbps		-89		dBm
Frequencies		2402		2480	MHz

Table 6: Bluetooth® LE radio characteristics (radiated)

2.5 Pin characteristics

Property	Min.	Typ.	Max.	Unit
Pin input low voltage	-0.3		0.25×VDD	V
Pin input high voltage	0.75×VDD		VDD+0.3	V
Pin output low voltage			0.1×VDD	V
Pin output high voltage	0.8×VDD			V
Pin output current sunk by any I/O and control pin		40		mA
Pin output current sourced by any I/O and control pin		28		mA
Internal pull-up/pull-down resistor		45		kΩ

Table 7: Pin characteristics

¹Refer to the Table 9 for the certified power settings. For the certification of the end device, the power index can be adjusted to achieve the maximum certifiable output power.

3 Pinout

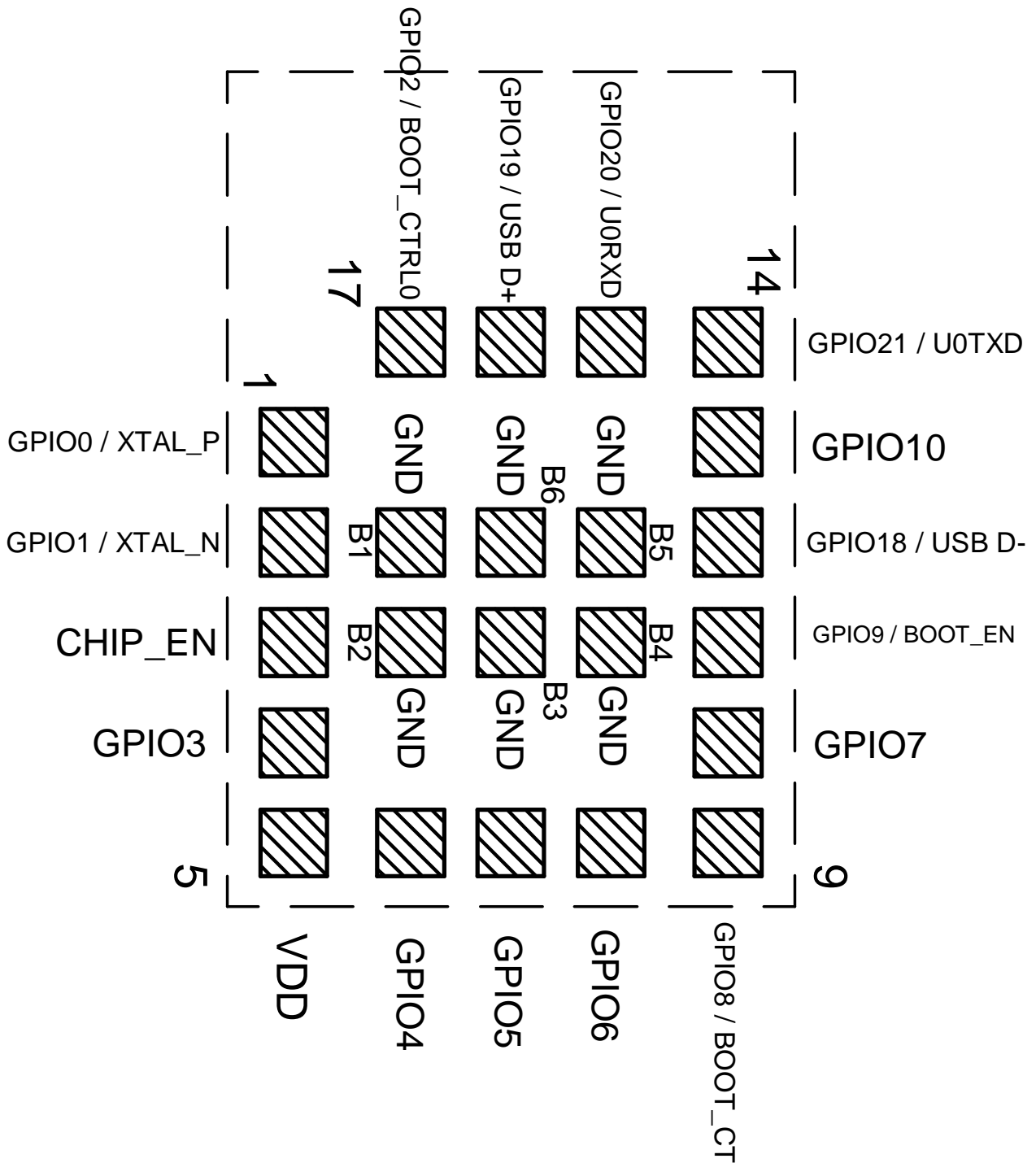

Figure 3: Pinout (top view)

No	µC Pin	I/O	Description
1	<i>GPIO0 / XTAL_P²</i>	I/O	General purpose input / output.
2	<i>GPIO1 / XTAL_N²</i>	I/O	General purpose input / output.
3	<i>CHIP_EN</i>	Input	Reset pin. A low signal resets the module.
4	<i>GPIO3</i>	I/O	General purpose input / output.
5	<i>VDD</i>	Supply	Supply voltage
6	<i>GPIO4</i>	I/O	General purpose input / output.
7	<i>GPIO5</i>	I/O	General purpose input / output.
8	<i>GPIO6</i>	I/O	General purpose input / output.
9	<i>GPIO8 / BOOT_CTRL1</i>	Input	Boot control pin. External 1.5 kΩ pull-up resistor needed.
10	<i>GPIO7</i>	I/O	General purpose input / output.
11	<i>GPIO9 / BOOT_EN</i>	Input	Boot control pin. Low level: Boot Mode. High level: Application mode. Uses internal pull-up ¹
12	<i>GPIO18 / USB D-³</i>	I/O	General purpose input / output.
13	<i>GPIO10</i>	I/O	General purpose input / output.
14	<i>GPIO21 / U0TXD</i>	Output	Debug UART (Transmission). Do not connect if not needed.
15	<i>GPIO20 / U0RXD</i>	Input	Debug UART (Reception). Uses internal pull-up resistor ¹ . Do not connect if not needed.
16	<i>GPIO19 / USB D+³</i>	I/O	General purpose input / output.
17	<i>GPIO2 / BOOT_CTRL0</i>	Input	Boot control pin. External 1.5 kΩ pull-up resistor needed.
B1 - B6	<i>GND</i>	Supply	Ground

Table 8: Pinout



The debug UART pin as well as the boot pins are used for programming/debugging the radio chip. During execution of the firmware, and in case no UART debug messages are used, these pins can be reconfigured and used as normal GPIOs.

¹Internal pull-ups or pull-downs (45 kΩ) are configured at start-up by the firmware installed in the SoC.

²Pins available to connect an external crystal.

³Pins available to connect a USB.

4 Radio power settings

The radio module Stephano-I (variant of Orthosie-I with firmware for Bluetooth® LE and WiFi support) has been certified using Bluetooth® LE and WiFi radio. It has passed the certification tests for several countries with the maximum output powers as stated below:

Country	Maximum Bluetooth® LE power index	Maximum WiFi power index
TELEC/Japan	12 (9 dBm)	74 (18.5 dBm)
RED/EU	13 (12 dBm)	80 (20 dBm)
FCC/US	13 (12 dBm)	80 (20 dBm)
IC/Canada	13 (12 dBm)	80 (20 dBm)

Table 9: Maximum allowed power setting



Note that the power index only defines the conducted output power of the radio chip. The actual output power radiated by the module's integrated antenna is lower due to the antenna loss. Refer to chapter `Electrical specifications` for more details about the radiated output power.

5 Design in guide

5.1 Advice for schematic and layout

For users with less RF experience it is advisable to closely copy the relating EV-Board with respect to schematic and layout, as it is a proven design. The layout should be conducted with particular care, because even small deficiencies could affect the radio performance and its range or even the conformity.

The following general advice should be taken into consideration:

- A clean, stable power supply is strongly recommended. Interference, especially oscillation can severely restrain range and conformity.
- Variations in voltage level should be avoided.
- LDOs, properly designed in, usually deliver a proper regulated voltage.
- Blocking capacitors and a ferrite bead in the power supply line can be included to filter and smoothen the supply voltage when necessary.



No fixed values can be recommended, as these depend on the circumstances of the application (main power source, interferences etc.).



The use of an external reset IC should be considered if one of the following points is relevant:



- The slew rate of the power supply exceeds the electrical specifications.
- The effect of different current consumptions on the voltage level of batteries or voltage regulators should be considered. The module draws higher currents in certain scenarios like start-up or radio transmit which may lead to a voltage drop on the supply. A restart under such circumstances should be prevented by ensuring that the supply voltage does not drop below the minimum specifications.
- Voltage levels below the minimum recommended voltage level may lead to malfunction. The reset pin of the module shall be held on LOW logic level whenever the VDD is not stable or below the minimum operating Voltage.
- Special care must be taken in case of battery powered systems.

- Elements for ESD protection should be placed on all pins that are accessible from the outside and should be placed close to the accessible area. For example, the RF-pin is accessible when using an external antenna and should be protected.
- ESD protection for the antenna connection must be chosen such as to have a minimum effect on the RF signal. For example, a protection diode with low capacitance such as the 8231606A or a 68 nH air-core coil connecting the RF-line to ground give good results.
- Placeholders for optional antenna matching or additional filtering are recommended.
- The antenna path should be kept as short as possible.



Again, no fixed values can be recommended, as they depend on the influencing circumstances of the application (antenna, interferences etc.).

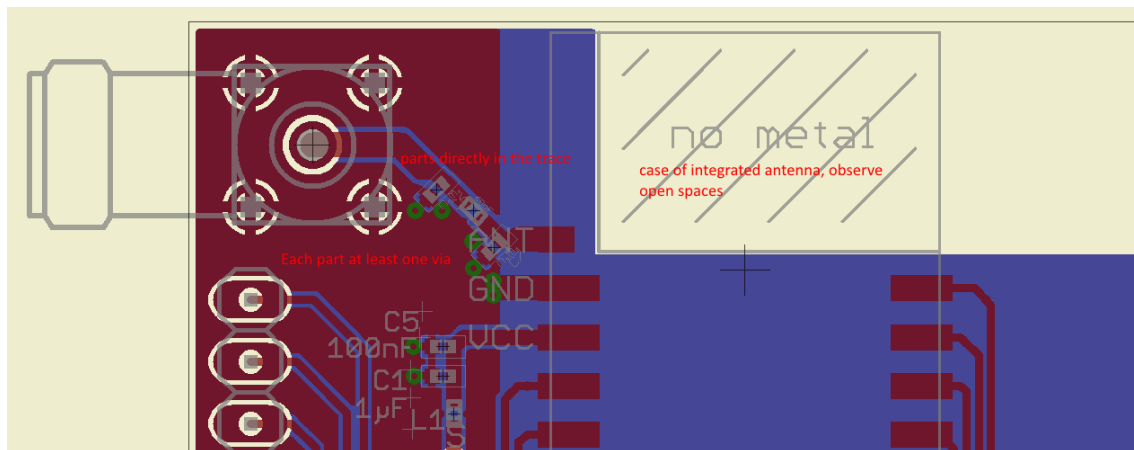

Figure 4: Layout

- To avoid the risk of short circuits and interference there should be no routing underneath the module on the top layer of the baseboard.
- On the second layer, a ground plane is recommended, to provide good grounding and shielding to any following layers and application environment.
- In case of integrated antennas it is required to have areas free from ground. This area should be copied from the EV-Board.
- The area with the integrated antenna must overlap with the carrier board and should not protrude, as it is matched to sitting directly on top of a PCB.
- Modules with integrated antennas should be placed with the antenna at the edge of the main board. It should not be placed in the middle of the main board or far away from the edge. This is to avoid tracks beside the antenna.

- Filter and blocking capacitors should be placed directly in the tracks without stubs, to achieve the best effect.
- Antenna matching elements should be placed close to the antenna / connector, blocking capacitors close to the module.
- Ground connections for the module and the capacitors should be kept as short as possible and with at least one separate through hole connection to the ground layer.
- ESD protection elements should be placed as close as possible to the exposed areas.

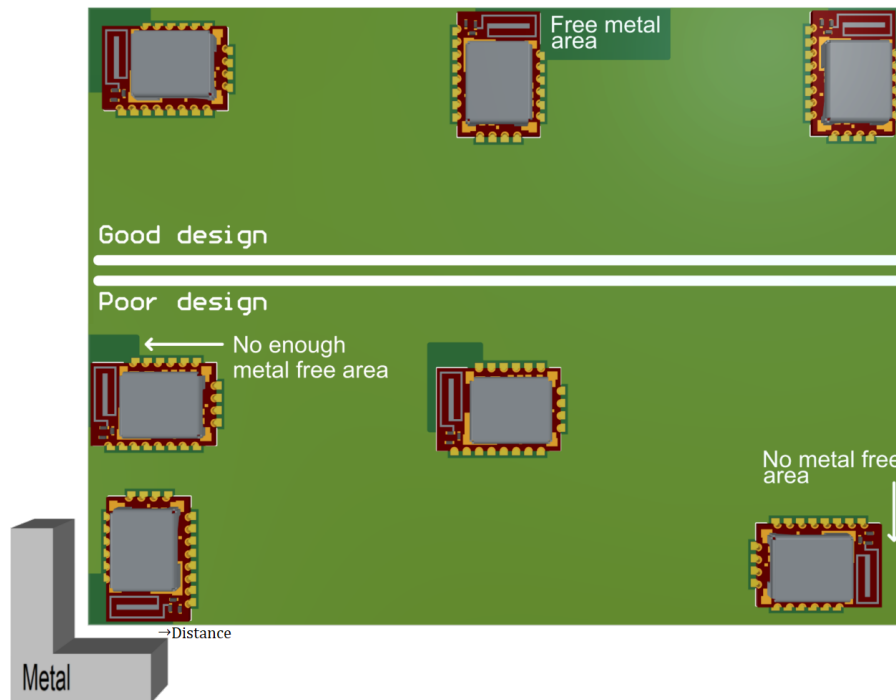

Figure 5: Placement of the module with integrated antenna

6 Reference design

Orthosie-I was tested and certified on the corresponding Orthosie-I evaluation board (order code 2617029022000). For the compliance with the EU directive 2014/53/EU Annex I, the evaluation board serves as reference design.

This is no discrepancy due to the fact that the evaluation board itself does not fall within the scope of the EU directive 2014/53/EU Annex I, as the module is tested on the evaluation board, which is also the recommended use.

Further information concerning the use of the evaluation board can be found in the manual of the Orthosie-I evaluation board.

6.1 EV-Board

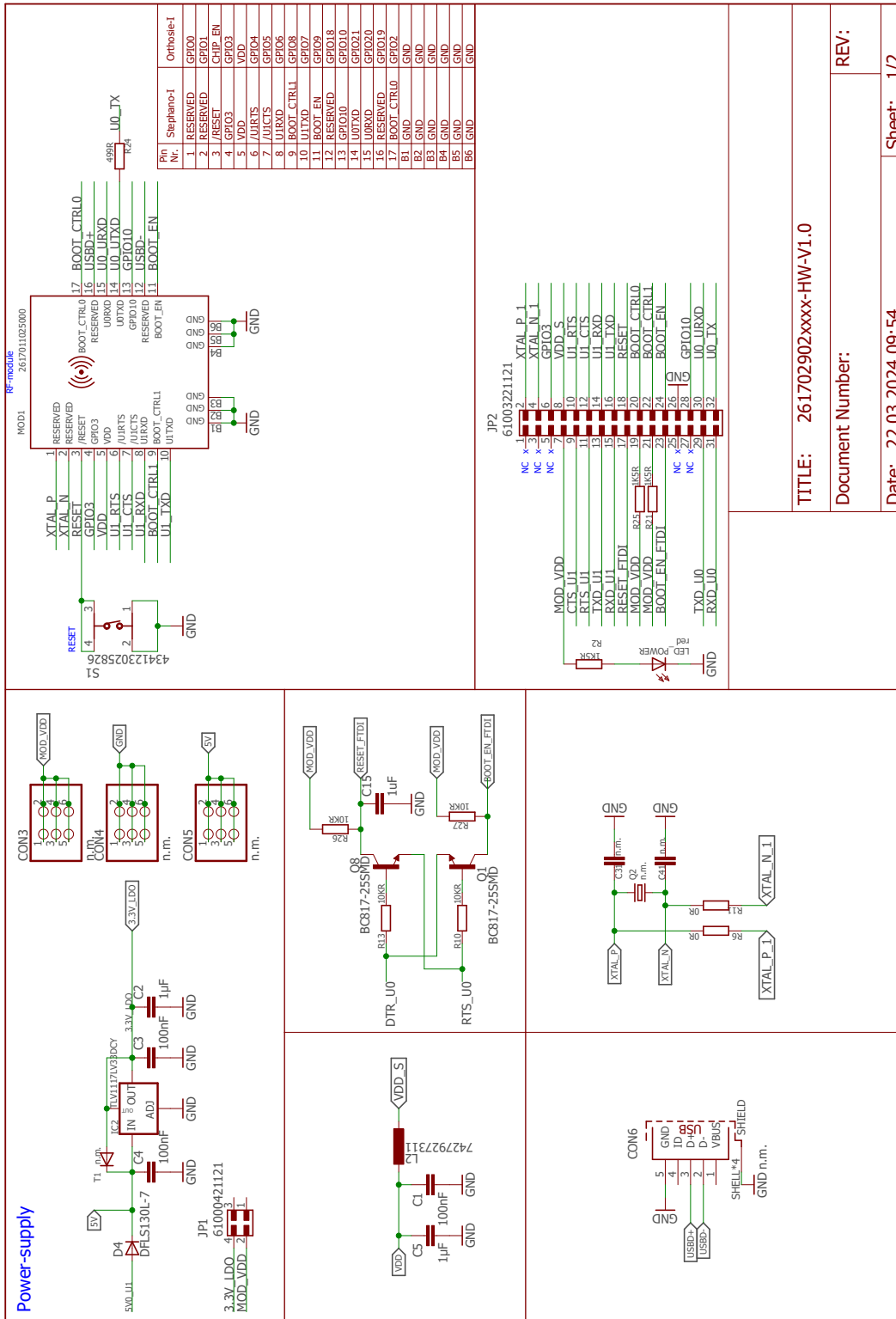
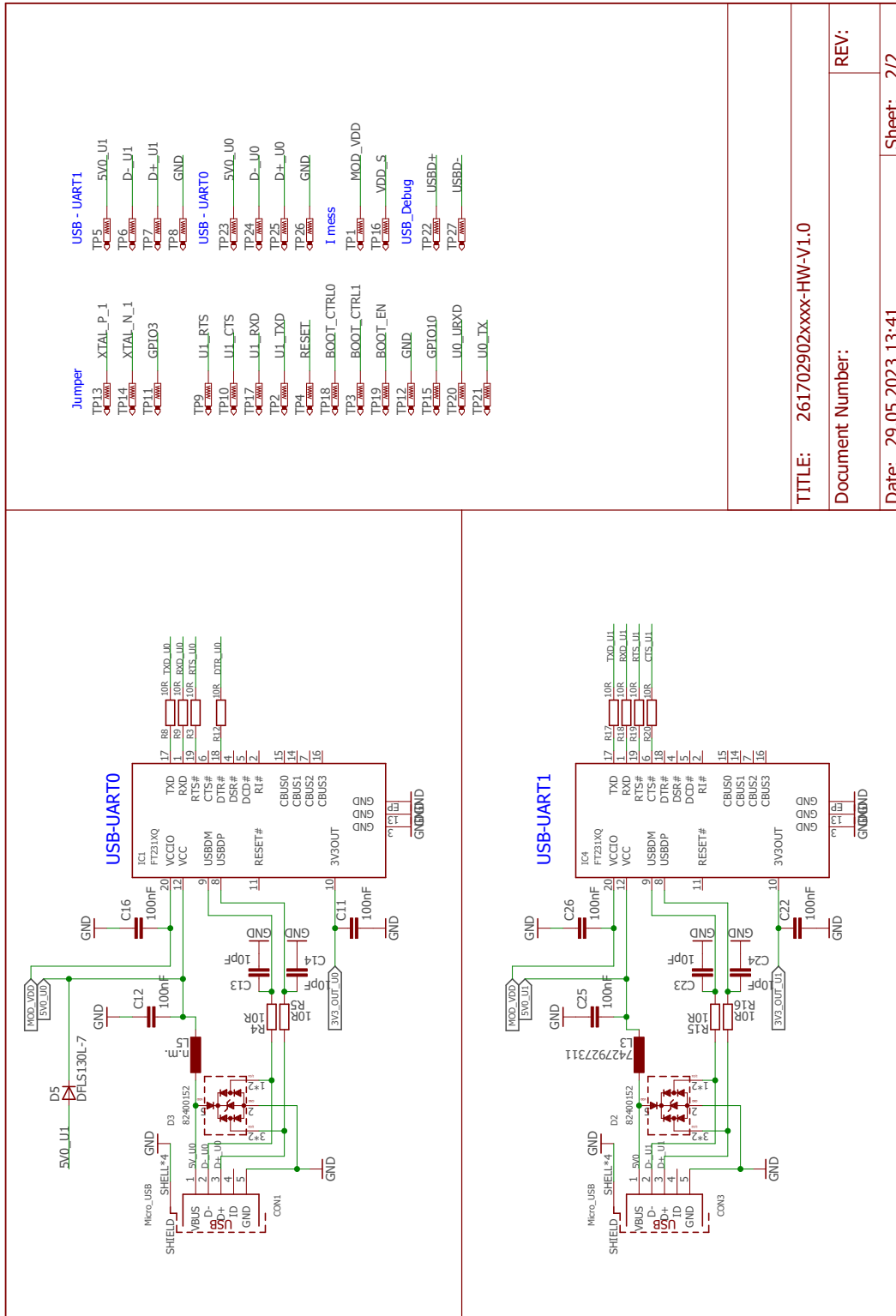

Figure 6: Reference design: schematic page 1



TITLE: 261702902xxxx-HW-V1.0

Document Number:

REV:

Date: 29.05.2023 13:41

Sheet: 2/2

Figure 7: Reference design: schematic page 2

6.2 Layout

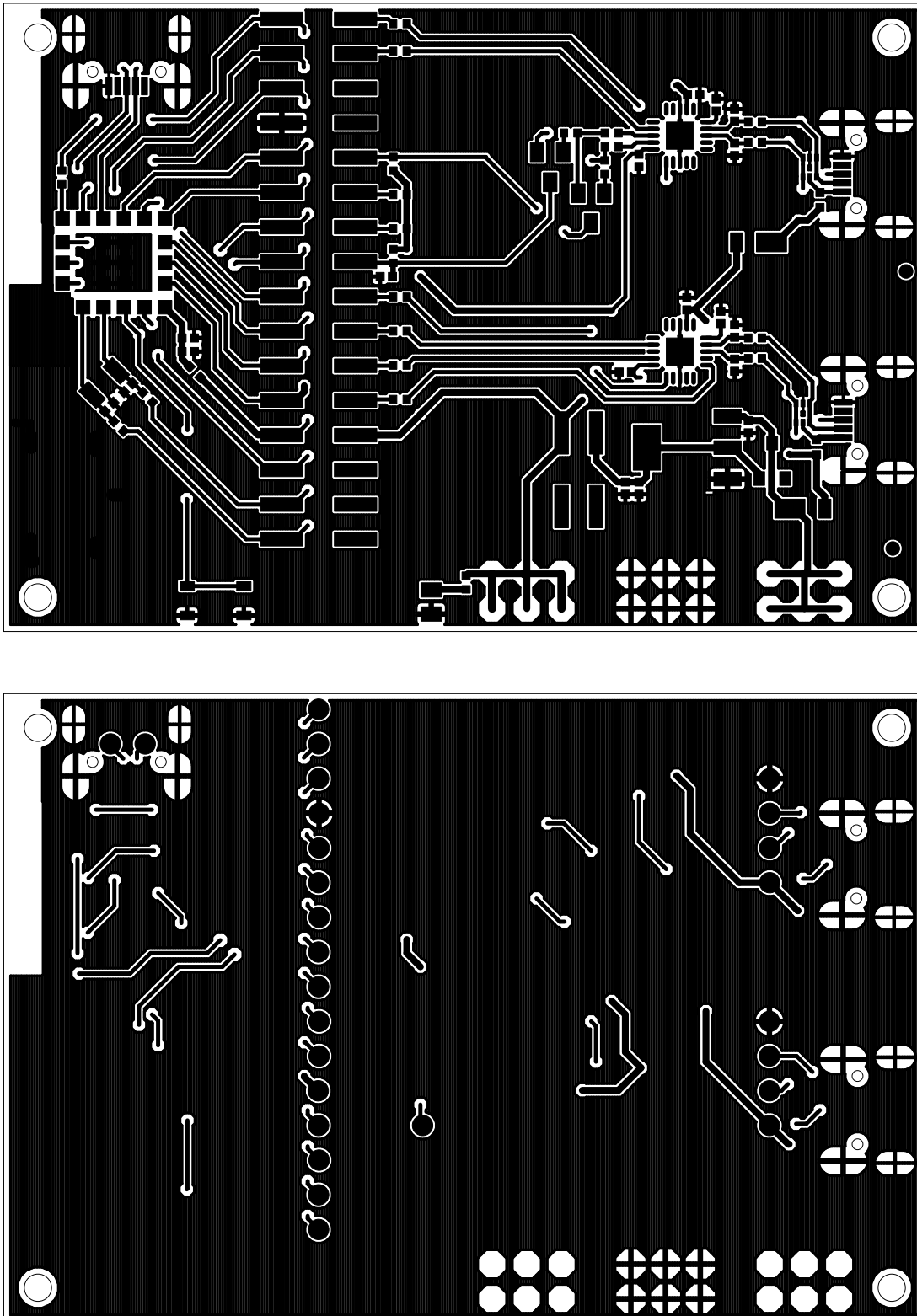

Figure 8: Top layer (top), bottom layer (bottom)

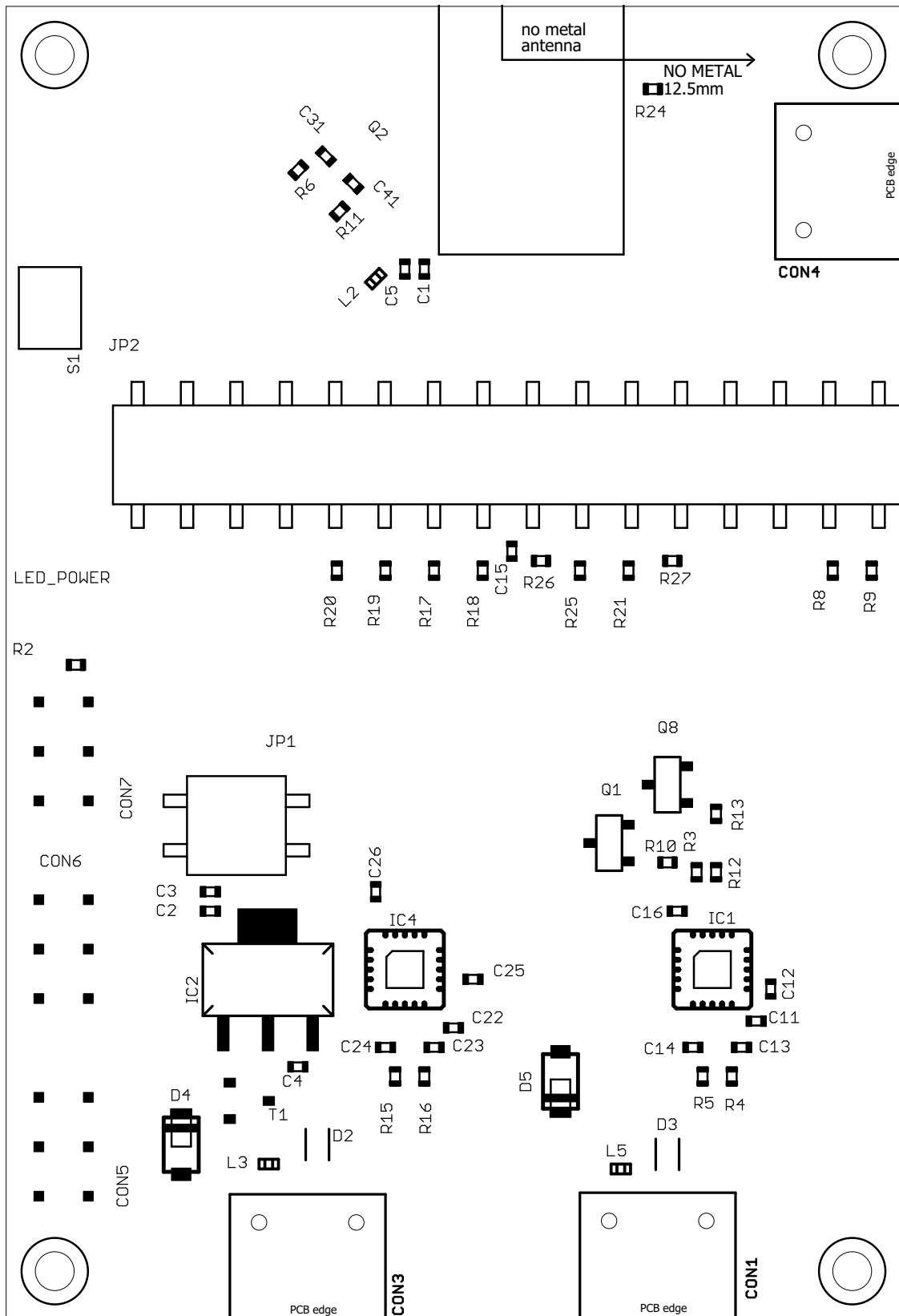

Figure 9: Reference design assembly plan

6.3 Flashing or erasing of the chipset

The debug UART (UART0) of the Orthosie-I is used to bring any kind of firmware on the module. Thus, the debug UART (UART0) must be accessible and an electronic circuit must be added, which controls the */RESET* and *BOOT_EN* pin of the radio module (see figure 10).

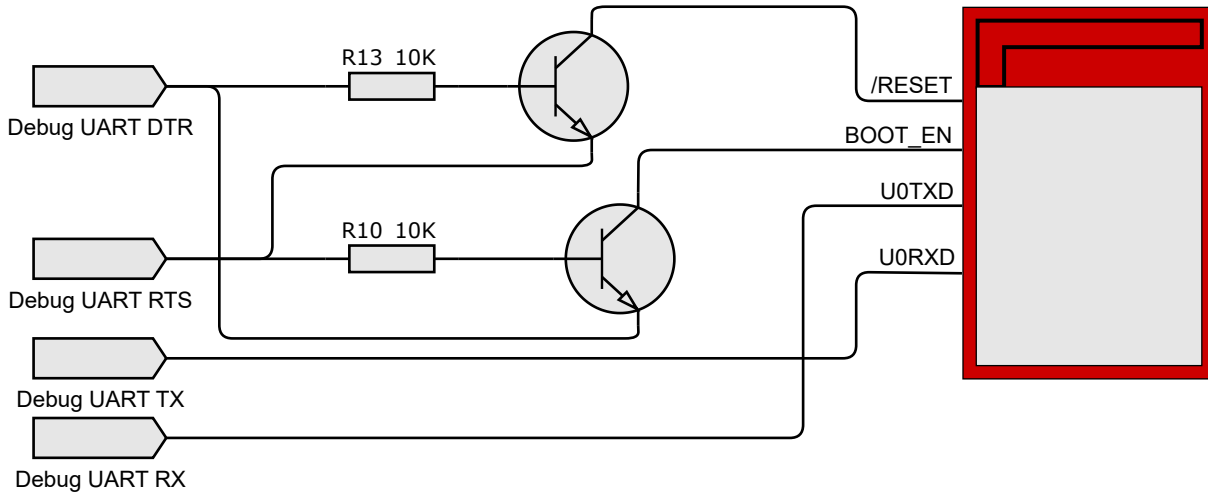

Figure 10: Flash circuit

Having the debug UART interface accessible, allows to erase or flash any kind of firmware on the module using the so called "Espressif Flash Download Tool" [2].



Please note that any PC tool provided by Espressif requires the hardware setup as shown in figure 10.

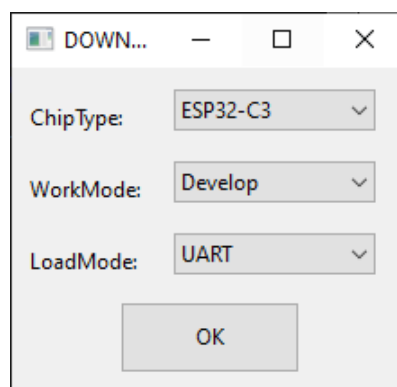

Figure 11: Flash download tool: Chip selection

After start-up of the tool, the selection of the ESP32-C3 chipset, firmware image, start address and the COM port of the debug UART, the radio module can be erased or flashed with a new firmware image.

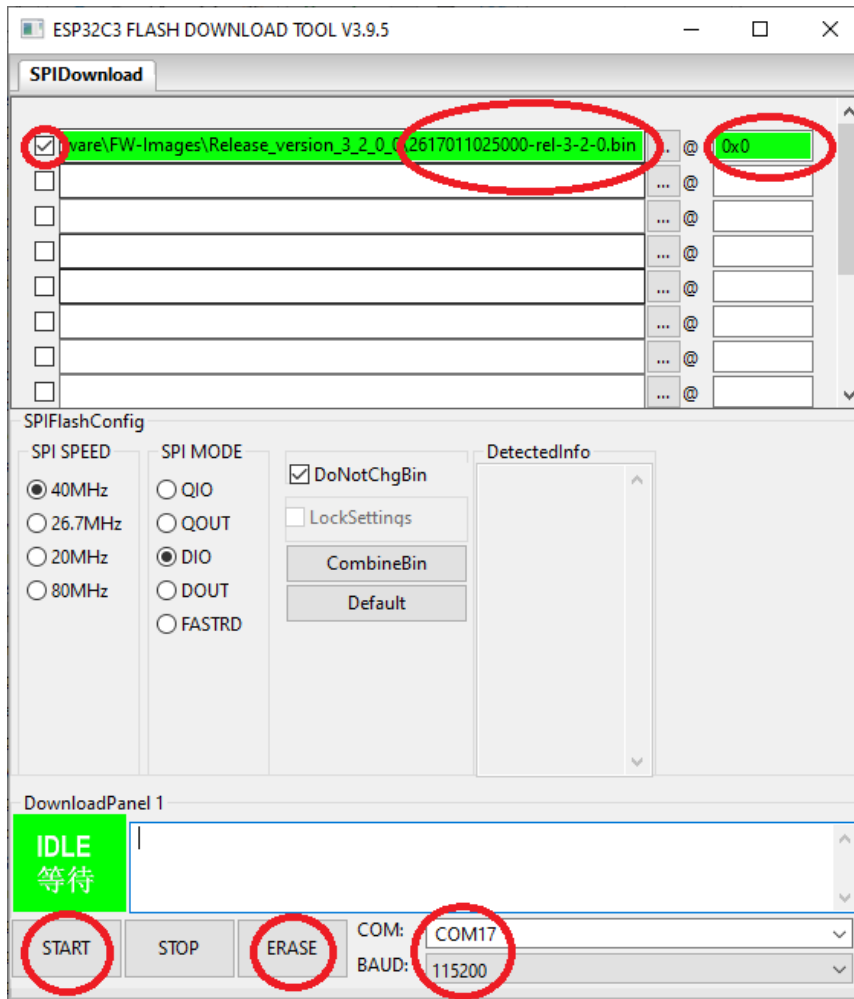

Figure 12: Flash download tool: Erase or flash chipset

7 Manufacturing information

7.1 Moisture sensitivity level

This wireless connectivity product is categorized as JEDEC Moisture Sensitivity Level 3 (MSL3), which requires special handling.

More information regarding the MSL requirements can be found in the IPC/JEDEC J-STD-020 standard on www.jedec.org.

More information about the handling, picking, shipping and the usage of moisture/reflow and/or process sensitive products can be found in the IPC/JEDEC J-STD-033 standard on www.jedec.org.

7.2 Soldering

7.2.1 Reflow soldering

Attention must be paid on the thickness of the solder resist between the host PCB top side and the modules bottom side. Only lead-free assembly is recommended according to JEDEC J-STD020.

Profile feature		Value
Preheat temperature Min	$T_{S \text{ Min}}$	150 °C
Preheat temperature Max	$T_{S \text{ Max}}$	200 °C
Preheat time from $T_{S \text{ Min}}$ to $T_{S \text{ Max}}$	t_S	60 - 120 seconds
Ramp-up rate (T_L to T_P)		3 °C / second max.
Liquidous temperature	T_L	217 °C
Time t_L maintained above T_L	t_L	60 - 150 seconds
Peak package body temperature	T_P	260 °C
Time within 5 °C of actual peak temperature	t_P	20 - 30 seconds
Ramp-down Rate (T_P to T_L)		6 °C / second max.
Time 20 °C to T_P		8 minutes max.

Table 10: Classification reflow soldering profile, Note: refer to IPC/JEDEC J-STD-020E

It is recommended to solder this module on the last reflow cycle of the PCB. For solder paste use a LFM-48W or Indium based SAC 305 alloy (Sn 96.5 / Ag 3.0 / Cu 0.5 / Indium 8.9HF / Type 3 / 89%) type 3 or higher.

The reflow profile must be adjusted based on the thermal mass of the entire populated PCB, heat transfer efficiency of the reflow oven and the specific type of solder paste used. Based on the specific process and PCB layout the optimal soldering profile must be adjusted and verified. Other soldering methods (e.g. vapor phase) have not been verified and have to be validated

by the customer at their own risk. Rework is not recommended.

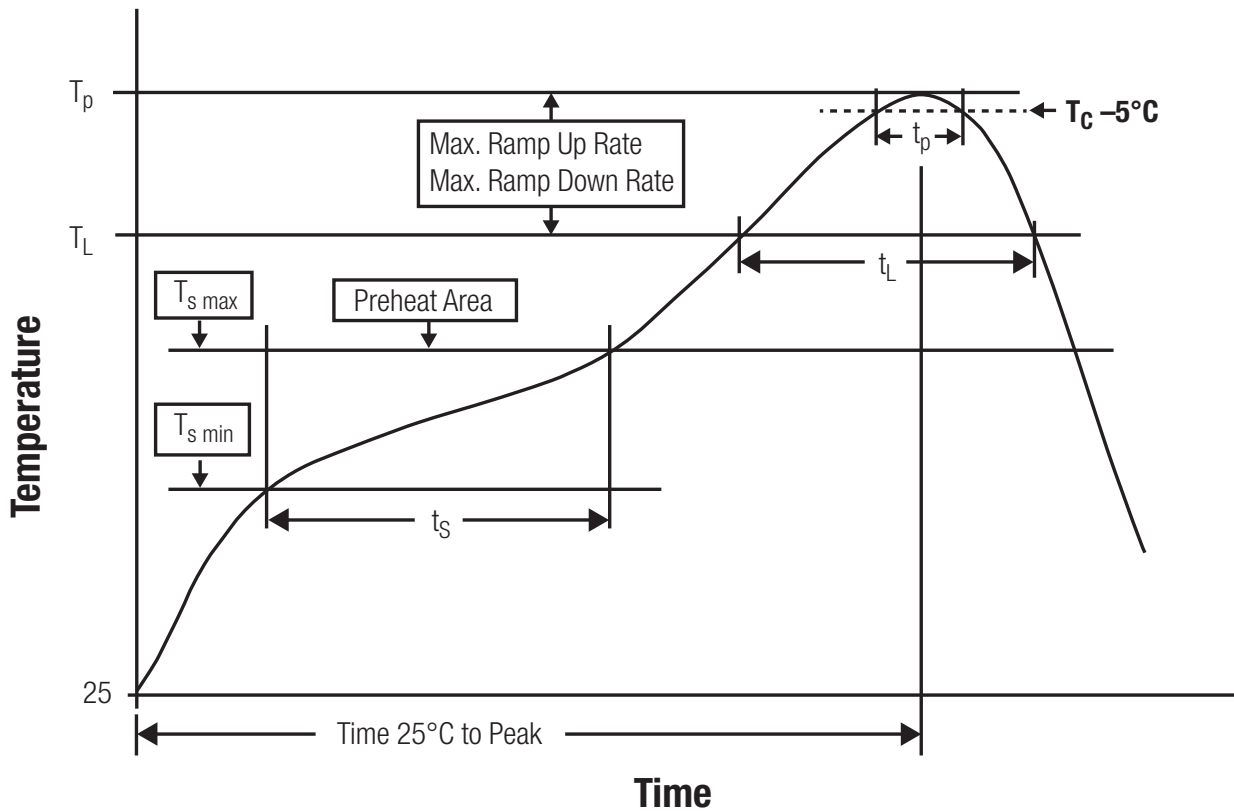

Figure 13: Reflow soldering profile

After reflow soldering, visually inspect the board to confirm proper alignment

7.2.2 Cleaning

Do not clean the product. Any residue cannot be easily removed by washing. Use a "no clean" soldering paste and do not clean the board after soldering.

- Do not clean the product with water. Capillary effects can draw water into the gap between the host PCB and the module, absorbing water underneath it. If water is trapped inside, it may short-circuit adjoining pads. The water may also destroy the label and ink-jet printed text on it.
- Cleaning processes using alcohol or other organic solvents may draw solder flux residues into the housing, which won't be detected in a post-wash inspection. The solvent may also destroy the label and ink-jet printed text on it.
- Do not use ultrasonic cleaning as it will permanently damage the part, particularly the crystal oscillators.

7.2.3 Potting and coating

- If the product is potted in the customer application, the potting material might shrink or expand during and after hardening. Shrinking could lead to an incomplete seal, allowing contaminants into the component. Expansion could damage components. We recommend a manual inspection after potting to avoid these effects.
- Conformal coating or potting results in loss of warranty.
- The RF shield will not protect the part from low-viscosity coatings and potting. An undefined amount of coating and potting will enter inside the shielding.
- Conformal coating and potting will influence the parts of the radio front end and consequently influence the radio performance.
- Potting will influence the temperature behaviour of the device. This might be critical for components with high power.

7.2.4 Other notations

- Do not attempt to improve the grounding by forming metal strips directly to the EMI covers or soldering on ground cables, as it may damage the part and will void the warranty.
- Always solder every pad to the host PCB even if some are unused, to improve the mechanical strength of the module.
- The part is sensitive to ultrasonic waves, as such do not use ultrasonic cleaning, welding or other processing. Any ultrasonic processing will void the warranty.

7.3 ESD handling

This product is highly sensitive to electrostatic discharge (ESD). As such, always use proper ESD precautions when handling. Make sure to handle the part properly throughout all stages of production, including on the host PCB where the module is installed. For ESD ratings, refer to the module series' maximum ESD section. For more information, refer to the relevant chapter 2. Failing to follow the aforementioned recommendations can result in severe damage to the part.

- the first contact point when handling the PCB is always between the local GND and the host PCB GND, unless there is a galvanic coupling between the local GND (for example work table) and the host PCB GND.
- Before assembling an antenna patch, connect the grounds.
- While handling the RF pin, avoid contact with any charged capacitors and be careful when contacting any materials that can develop charges (for example coaxial cable with around 50-80 pF/m, patch antenna with around 10 pF, soldering iron etc.)
- Do not touch any exposed area of the antenna to avoid electrostatic discharge. Do not let the antenna area be touched in a non ESD-safe manner.
- When soldering, use an ESD-safe soldering iron.

7.4 Safety recommendations

It is your duty to ensure that the product is allowed to be used in the destination country and within the required environment. Usage of the product can be dangerous and must be tested and verified by the end user. Be especially careful of:

- Use in areas with risk of explosion (for example oil refineries, gas stations).
- Use in areas such as airports, aircraft, hospitals, etc., where the product may interfere with other electronic components.

It is the customer's responsibility to ensure compliance with all applicable legal, regulatory and safety-related requirements as well as applicable environmental regulations. Disassembling the product is not allowed. Evidence of tampering will void the warranty.

- Compliance with the instructions in the product manual is recommended for correct product set-up.
- The product must be provided with a consolidated voltage source. The wiring must meet all applicable fire and security prevention standards.
- Handle with care. Avoid touching the pins as there could be ESD damage.

Be careful when working with any external components. When in doubt consult the technical documentation and relevant standards. Always use an antenna with the proper characteristics.



Würth Elektronik eiSos radio modules with high output power of up to 500 mW, as for example the radio module Thebe-II, generate a high amount of warmth while transmitting. The manufacturer of the end device must take care of potentially necessary actions for his application.

8 Physical specifications

8.1 Dimensions

Dimensions
9.5 x 13 x 2 mm

Table 11: Dimensions

8.2 Weight

Weight
<1 g

Table 12: Weight

8.3 Module drawing

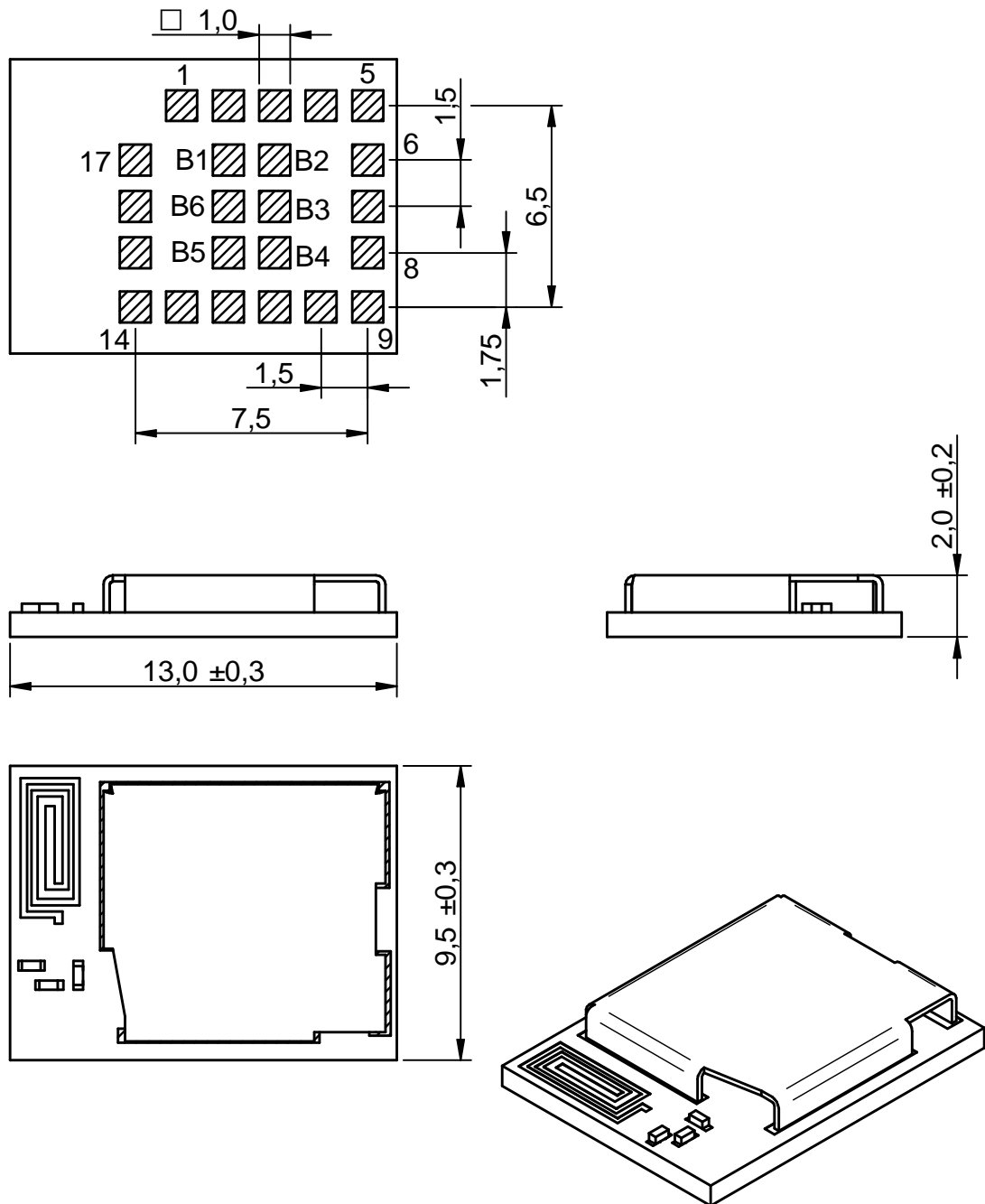

Figure 14: Module dimensions [mm]

8.4 Footprint

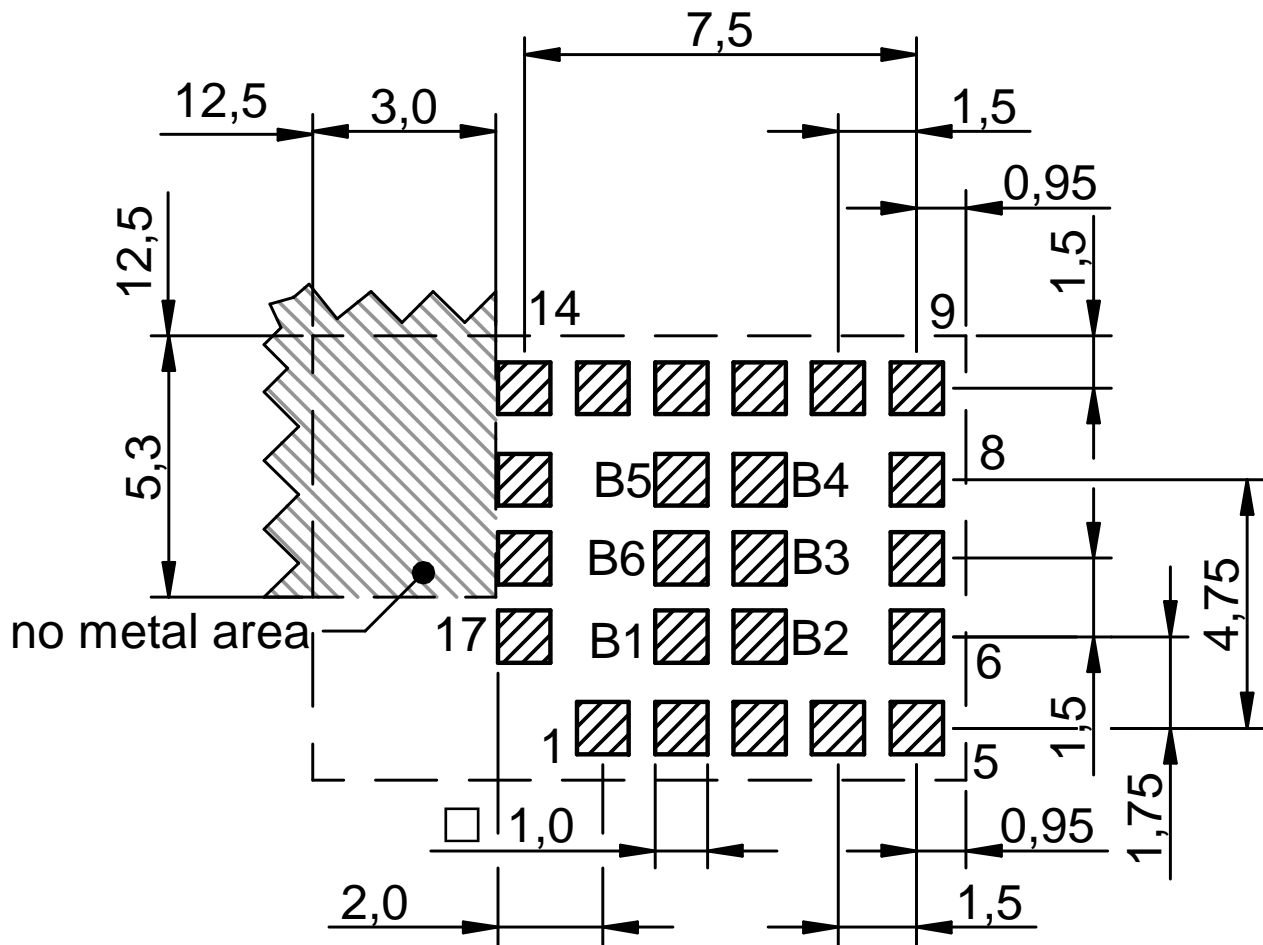

Figure 15: Footprint [mm]

8.5 Antenna free area

To avoid influence and mismatching of the antenna, the recommended free area around the antenna should be maintained. As rule of thumb, a minimum distance of metal parts to the antenna of $\lambda/10$ should be kept (see figure 15). Even though metal parts would influence the characteristic of the antenna, but the direct influence and matching keep an acceptable level.

9 Marking

9.1 Lot number

The 15 digit lot number is printed in numerical digits as well as in form of a machine readable bar code. It is divided into 5 blocks as shown in the following picture and can be translated according to the following table.

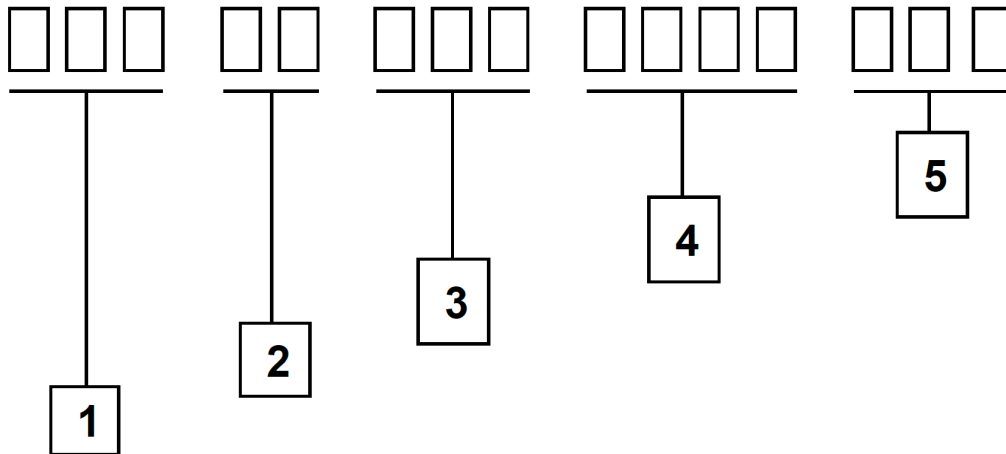

Figure 16: Lot number structure

Block	Information	Example(s)
1	eiSos internal, 3 digits	439
2	eiSos internal, 2 digits	01
3	Hardware version, 3 digits	V2.4 = 024, V12.2 = 122
4	Date code, 4 digits	1703 = week 03 in year 2017, 1816 = week 16 in year 2018
5	Firmware version, 3 digits	V3.2 = 302, V5.13 = 513

Table 13: Lot number details

As the user can perform a firmware update the printed lot number only shows the factory delivery state. The currently installed firmware can be requested from the module using the corresponding product specific command. The firmware version as well as the hardware version are restricted to show only major and minor version not the patch identifier.

9.2 General labeling information

Labels of Würth Elektronik eiSos radio modules include several fields. Besides the manufacturer identification, the product's *WE* order code, serial number and certification information are placed on the label. In case of small labels, additional certification marks are placed on the label of the reel.

The informations on the label are fixed. Only the serial number changes with each entity of the radio module. For Orthosie-I the label is as follows:

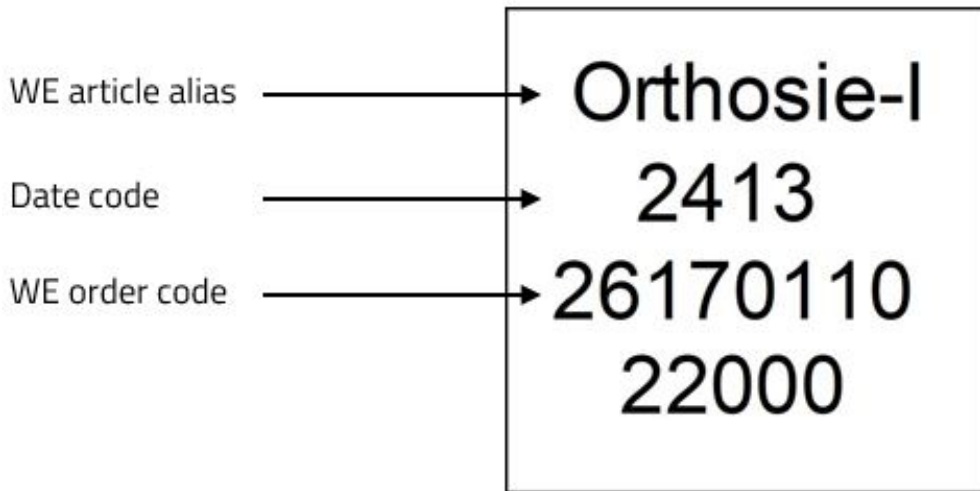

Figure 17: Label of the Orthosie-I

10 Information for explosion protection

In case the end product should be used in explosion protection areas, the following information can be used:

- The module itself is unfused.
- The maximum power of the module is 15 dBm for internal antenna.
- The total amount of capacitance of all capacitors is 3.61 μF .
- The total amount of inductance of all inductors is 27.9 nH.

11 Bluetooth SIG listing/qualification

Type	Data
Design name	Stephano-I
Declaration ID	D066310
QDID	227283 (Controller Subsystem) ¹
Specification name	Bluetooth® LE 5.0
Project type	End product

Each product containing intellectual property of the Bluetooth® Special Interest Group (SIG) must be qualified by the SIG to obtain the corresponding declaration ID.

Due to the qualification as "Controller Subsystem", no further Bluetooth® LE tests are required. The only arising expenses are those for purchasing a Bluetooth® declaration ID.

To obtain the Bluetooth® listing of the end device, refer to the application note ANR027 [3].

¹For listing of the end device, the controller subsystem QDID (227283) must be used in addition to the QDID of the Bluetooth® LE stack. For example the stack "ESP-IDF Bluedroid Host" with QDID 198312 listed as "Host Subsystem" can be used.

12 References

- [1] Espressif. Espressif SDKs. <https://www.espressif.com/en/products/software/esp-sdk/overview>.
- [2] Espressif. Espressif tools download page. <https://www.espressif.com/en/support/download/other-tools>.
- [3] Würth Elektronik. Application note 27 - Bluetooth listing guide. <http://www.we-online.com/ANR027>.

13 Important notes

The following conditions apply to all goods within the wireless connectivity and sensors product range of Würth Elektronik eiSos GmbH & Co. KG:

General customer responsibility

Some goods within the product range of Würth Elektronik eiSos GmbH & Co. KG contain statements regarding general suitability for certain application areas. These statements about suitability are based on our knowledge and experience of typical requirements concerning the areas, serve as general guidance and cannot be estimated as binding statements about the suitability for a customer application. The responsibility for the applicability and use in a particular customer design is always solely within the authority of the customer. Due to this fact, it is up to the customer to evaluate, where appropriate to investigate and to decide whether the device with the specific product characteristics described in the product specification is valid and suitable for the respective customer application or not. Accordingly, the customer is cautioned to verify that the documentation is current before placing orders.

Customer responsibility related to specific, in particular safety-relevant applications

It has to be clearly pointed out that the possibility of a malfunction of electronic components or failure before the end of the usual lifetime cannot be completely eliminated in the current state of the art, even if the products are operated within the range of the specifications. The same statement is valid for all software source code and firmware parts contained in or used with or for products in the wireless connectivity and sensor product range of Würth Elektronik eiSos GmbH & Co. KG. In certain customer applications requiring a high level of safety and especially in customer applications in which the malfunction or failure of an electronic component could endanger human life or health, it must be ensured by most advanced technological aid of suitable design of the customer application that no injury or damage is caused to third parties in the event of malfunction or failure of an electronic component.

Best care and attention

Any product-specific data sheets, manuals, application notes, PCN's, warnings and cautions must be strictly observed in the most recent versions and matching to the products revisions. This documents can be downloaded from the product specific sections on the wireless connectivity and sensors homepage.

Customer support for product specifications

Some products within the product range may contain substances, which are subject to restrictions in certain jurisdictions in order to serve specific technical requirements. Necessary information is available on request. In this case, the field sales engineer or the internal sales person in charge should be contacted who will be happy to support in this matter.

Product improvements

Due to constant product improvement, product specifications may change from time to time. As a standard reporting procedure of the Product Change Notification (PCN) according to the JEDEC-Standard, we inform about major changes. In case of further queries regarding the PCN, the field sales engineer, the internal sales person or the technical support team in charge should be contacted. The basic responsibility of the customer as per section 13 and 13 remains unaffected.

All software like "wireless connectivity SDK", "Sensor SDK" or other source codes as well as all PC software tools are not subject to the Product Change Notification information process.

Product life cycle

Due to technical progress and economical evaluation we also reserve the right to discontinue production and delivery of products. As a standard reporting procedure of the Product Termination Notification (PTN) according to the JEDEC-Standard we will inform at an early stage about inevitable product discontinuance. According to this, we cannot ensure that all products within our product range will always be available. Therefore, it needs to be verified with the field sales engineer or the internal sales person in charge about the current product availability expectancy before or when the product for application design-in disposal is considered. The approach named above does not apply in the case of individual agreements deviating from the foregoing for customer-specific products.

Property rights

All the rights for contractual products produced by Würth Elektronik eiSos GmbH & Co. KG on the basis of ideas, development contracts as well as models or templates that are subject to copyright, patent or commercial protection supplied to the customer will remain with Würth Elektronik eiSos GmbH & Co. KG. Würth Elektronik eiSos GmbH & Co. KG does not warrant or represent that any license, either expressed or implied, is granted under any patent right, copyright, mask work right, or other intellectual property right relating to any combination, application, or process in which Würth Elektronik eiSos GmbH & Co. KG components or services are used.

General terms and conditions

Unless otherwise agreed in individual contracts, all orders are subject to the current version of the "General Terms and Conditions of Würth Elektronik eiSos Group", last version available at www.we-online.com.

14 Legal notice

Exclusion of liability

Würth Elektronik eiSos GmbH & Co. KG considers the information in this document to be correct at the time of publication. However, Würth Elektronik eiSos GmbH & Co. KG reserves the right to modify the information such as technical specifications or functions of its products or discontinue the production of these products or the support of one of these products without any written announcement or notification to customers. The customer must make sure that the information used corresponds to the latest published information. Würth Elektronik eiSos GmbH & Co. KG does not assume any liability for the use of its products. Würth Elektronik eiSos GmbH & Co. KG does not grant licenses for its patent rights or for any other of its intellectual property rights or third-party rights.

Notwithstanding anything above, Würth Elektronik eiSos GmbH & Co. KG makes no representations and/or warranties of any kind for the

provided information related to their accuracy, correctness, completeness, usage of the products and/or usability for customer applications. Information published by Würth Elektronik eiSos GmbH & Co. KG regarding third-party products or services does not constitute a license to use such products or services or a warranty or endorsement thereof.

Suitability in customer applications

The customer bears the responsibility for compliance of systems or units, in which Würth Elektronik eiSos GmbH & Co. KG products are integrated, with applicable legal regulations. Customer acknowledges and agrees that it is solely responsible for compliance with all legal, regulatory and safety-related requirements concerning its products, and any use of Würth Elektronik eiSos GmbH & Co. KG components in its applications, notwithstanding any applications-related information or support that may be provided by Würth Elektronik eiSos GmbH & Co. KG. Customer represents and agrees that it has all the necessary expertise to create and implement safeguards which anticipate dangerous consequences of failures, monitor failures and their consequences lessen the likelihood of failures that might cause harm and take appropriate remedial actions. The customer will fully indemnify Würth Elektronik eiSos GmbH & Co. KG and its representatives against any damages arising out of the use of any Würth Elektronik eiSos GmbH & Co. KG components in safety-critical applications.

Trademarks

AMBER wireless is a registered trademark of Würth Elektronik eiSos GmbH & Co. KG. All other trademarks, registered trademarks, and product names are the exclusive property of the respective owners.

Usage restriction

Würth Elektronik eiSos GmbH & Co. KG products have been designed and developed for usage in general electronic equipment only. This product is not authorized for use in equipment where a higher safety standard and reliability standard is especially required or where a failure of the product is reasonably expected to cause severe personal injury or death, unless the parties have executed an agreement specifically governing such use. Moreover, Würth Elektronik eiSos GmbH & Co. KG products are neither designed nor intended for use in areas such as military, aerospace, aviation, nuclear control, submarine, transportation (automotive control, train control, ship control), transportation signal, disaster prevention, medical, public information network etc. Würth Elektronik eiSos GmbH & Co. KG must be informed about the intent of such usage before the design-in stage. In addition, sufficient reliability evaluation checks for safety must be performed on every electronic component, which is used in electrical circuits that require high safety and reliability function or performance. By using Würth Elektronik eiSos GmbH & Co. KG products, the customer agrees to these terms and conditions.

15 License terms

These License terms will take effect upon the purchase and usage of the Würth Elektronik eiSos GmbH & Co. KG wireless connectivity products. You hereby agree that these license terms are applicable to the product and the incorporated software, firmware and source codes (collectively, "Software") made available by Würth Elektronik eiSos in any form, including but not limited to binary, executable or source code form. The software included in any Würth Elektronik eiSos wireless connectivity product is purchased to you on the condition that you accept the terms and conditions of these license terms. You agree to comply with all provisions under these license terms.

Limited license

Würth Elektronik eiSos hereby grants you a limited, non-exclusive, non-transferable and royalty-free license to use the software and under the conditions that will be set forth in these license terms. You are free to use the provided software only in connection with one of the products from Würth Elektronik eiSos to the extent described in these license terms. You are entitled to change or alter the source code for the sole purpose of creating an application embedding the Würth Elektronik eiSos wireless connectivity product. The transfer of the source code to third parties is allowed to the sole extent that the source code is used by such third parties in connection with our product or another hardware provided by Würth Elektronik eiSos under strict adherence of these license terms. Würth Elektronik eiSos will not assume any liability for the usage of the incorporated software and the source code. You are not entitled to transfer the source code in any form to third parties without prior written consent of Würth Elektronik eiSos.

You are not allowed to reproduce, translate, reverse engineer, decompile, disassemble or create derivative works of the incorporated software and the source code in whole or in part. No more extensive rights to use and exploit the products are granted to you.

Usage and obligations

The responsibility for the applicability and use of the Würth Elektronik eiSos wireless connectivity product with the incorporated firmware in a particular customer design is always solely within the authority of the customer. Due to this fact, it is up to you to evaluate and investigate, where appropriate, and to decide whether the device with the specific product characteristics described in the product specification is valid and suitable for your respective application or not.

You are responsible for using the Würth Elektronik eiSos wireless connectivity product with the incorporated firmware in compliance with all applicable product liability and product safety laws. You acknowledge to minimize the risk of loss and harm to individuals and bear the risk for failure leading to personal injury or death due to your usage of the product.

Würth Elektronik eiSos' products with the incorporated firmware are not authorized for use in safety-critical applications, or where a failure of the product is reasonably expected to cause severe personal injury or death. Moreover, Würth Elektronik eiSos' products with the incorporated firmware are neither designed nor intended for use in areas such as military, aerospace, aviation, nuclear control, submarine, transportation (automotive control, train control, ship control), transportation signal, disaster prevention, medical, public information network etc. You shall inform Würth Elektronik eiSos about the intent of such usage before design-in stage. In certain customer applications requiring a very high level of safety and in which the malfunction or failure of an electronic component could endanger human life or health, you must ensure to have all necessary expertise in the safety and regulatory ramifications of your applications. You acknowledge and agree that you are solely responsible for all legal, regulatory and safety-related requirements concerning your products and any use of Würth Elektronik eiSos' products with the incorporated firmware in such safety-critical applications, notwithstanding any applications-related information or support that may be provided by Würth Elektronik eiSos. **YOU SHALL INDEMNIFY WÜRTH ELEKTRONIK EISOS AGAINST ANY DAMAGES ARISING OUT OF THE USE OF WÜRTH ELEKTRONIK EISOS' PRODUCTS WITH THE INCORPORATED FIRMWARE IN SUCH SAFETY-CRITICAL APPLICATIONS.**

Ownership

The incorporated firmware created by Würth Elektronik eiSos is and will remain the exclusive property of Würth Elektronik eiSos.

Firmware update(s)

You have the opportunity to request the current and actual firmware for a bought wireless connectivity product within the time of warranty. However, Würth Elektronik eiSos has no obligation to update a modules firmware in their production facilities, but can offer this as a service on request. The upload of firmware updates falls within your responsibility, e.g. via ACC or another software for firmware updates. Firmware updates will not be communicated automatically. It is within your responsibility to check the current version of a firmware in the latest version of the product manual on our website. The revision table in the product manual provides all necessary information about firmware updates. There is no right to be provided with binary files, so called "firmware images", those could be flashed through JTAG, SWD, Spi-Bi-Wire, SPI or similar interfaces.

Disclaimer of warranty

THE FIRMWARE IS PROVIDED "AS IS". YOU ACKNOWLEDGE THAT WÜRTH ELEKTRONIK EISOS MAKES NO REPRESENTATIONS AND WARRANTIES OF ANY KIND RELATED TO, BUT NOT LIMITED TO THE NON-INFRINGEMENT OF THIRD PARTIES' INTELLECTUAL PROPERTY RIGHTS OR THE MERCHANTABILITY OR FITNESS FOR YOUR INTENDED PURPOSE OR USAGE. WÜRTH ELEKTRONIK EISOS DOES NOT WARRANT OR REPRESENT THAT ANY LICENSE, EITHER EXPRESS OR IMPLIED, IS GRANTED UNDER ANY PATENT RIGHT, COPYRIGHT, MASK WORK RIGHT, OR OTHER INTELLECTUAL PROPERTY RIGHT RELATING TO ANY COMBINATION, MACHINE, OR PROCESS IN WHICH THE WÜRTH ELEKTRONIK EISOS' PRODUCT WITH THE INCORPORATED FIRMWARE IS USED. INFORMATION PUBLISHED BY WÜRTH ELEKTRONIK EISOS REGARDING THIRD-PARTY PRODUCTS OR SERVICES DOES NOT CONSTITUTE A LICENSE FROM WÜRTH ELEKTRONIK EISOS TO USE SUCH PRODUCTS OR SERVICES OR A WARRANTY OR ENDORSEMENT THEREOF.

Limitation of liability

Any liability not expressly provided by Würth Elektronik eiSos shall be disclaimed.

You agree to hold us harmless from any third-party claims related to your usage of the Würth Elektronik eiSos' products with the incorporated firmware, software and source code. Würth Elektronik eiSos disclaims any liability for any alteration, development created by you or your customers as well as for any combination with other products.

Applicable law and jurisdiction

Applicable law to these license terms shall be the laws of the Federal Republic of Germany. Any dispute, claim or controversy arising out of or relating to these license terms shall be resolved and finally settled by the court competent for the location of Würth Elektronik eiSos registered office.

Severability clause

If a provision of these license terms is or becomes invalid, unenforceable or null and void, this shall not affect the remaining provisions of the terms. The parties shall replace any such provisions with new valid provisions that most closely approximate the purpose of the terms.

Miscellaneous

Würth Elektronik eiSos reserves the right at any time to change this terms at its own discretion. It is your responsibility to check at Würth Elektronik eiSos homepage for any updates. Your continued usage of the products will be deemed as the acceptance of the change.

We recommend you to be updated about the status of new firmware and software, which is available on our website or in our data sheet and manual, and to implement new software in your device where appropriate.

By ordering a product, you accept these license terms in all terms.

List of Figures

1	Orthosie-I	6
2	Block diagram	7
3	Pinout (top view)	10
4	Layout	14
5	Placement of the module with integrated antenna	15
6	Reference design: schematic page 1	17
7	Reference design: schematic page 2	18
8	Top layer (top), bottom layer (bottom)	19
9	Reference design assembly plan	20
10	Flash circuit	21
11	Flash download tool: Chip selection	21
12	Flash download tool: Erase or flash chipset	22
13	Reflow soldering profile	24
14	Module dimensions [mm]	28
15	Footprint [mm]	29
16	Lot number structure	30
17	Label of the Orthosie-I	31

List of Tables

1	Ordering information	7
2	Recommended operating conditions	8
3	Absolute maximum ratings	8
4	Power consumption	8
5	WiFi radio characteristics (radiated)	9
6	Bluetooth® LE radio characteristics (radiated)	9
7	Pin characteristics	9
8	Pinout	11
9	Maximum allowed power setting	12
10	Classification reflow soldering profile, Note: refer to IPC/JEDEC J-STD-020E	23
11	Dimensions	27
12	Weight	27
13	Lot number details	30



Contact

Würth Elektronik eiSos GmbH & Co. KG
Division Wireless Connectivity & Sensors

Max-Eyth-Straße 1
74638 Waldenburg
Germany

Tel.: +49 651 99355-0
Fax.: +49 651 99355-69
www.we-online.com/wireless-connectivity

WÜRTH ELEKTRONIK MORE THAN YOU EXPECT