

650nm 7mW 70 °C Reliable Operation! Ideal for DVD optical pick-up head

• Features

1. Low operating current
2. Higher power
3. High efficiency

• Applications

1. DVD player/ROM optical pick up
2. Combo drive optical pick up
3. Bar code scanner

• Absolute maximum ratings

Parameter	Symbol	Condition	Rating	Unit
Light output power	P_O	CW	10	mW
Reverse voltage (LD)	V_{RL}	-	2	V
Reverse voltage (PD)	V_{RD}	-	30	V
Forward current (PD)	I_{FD}	-	10	mA
Case temperature	T_C	-	-10~+70	°C
Storage temperature	T_S	-	-40~+85	°C

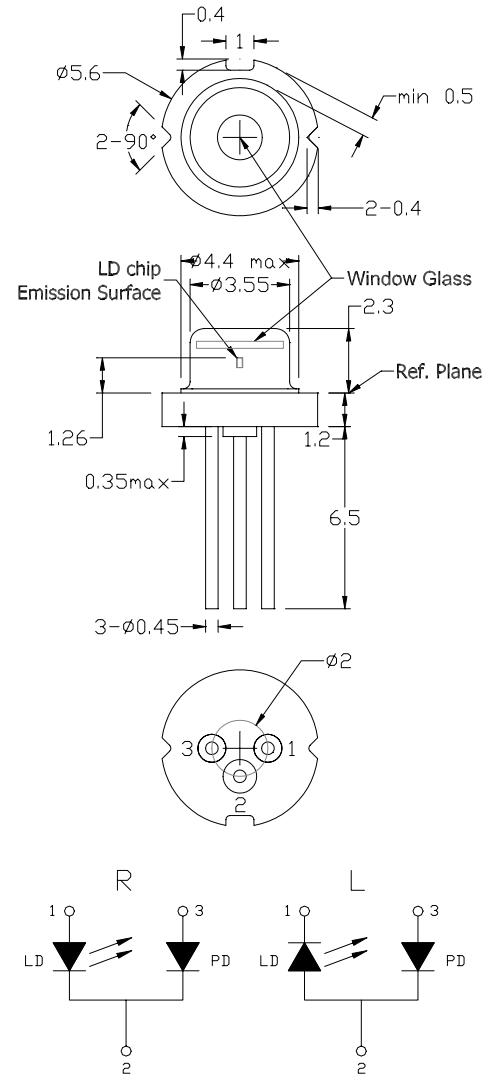

• Electrical and optical characteristics ($T_c=25^\circ\text{C}$)

Parameter	Symbol	Min.	Typ.	Max.	Unit	Conditions
Peak wavelength	λ	645	655	660	nm	$P_o=7\text{mW}$
Threshold current	I_{th}	-	20	25	mA	
Operating current	I_{op}	-	25	35	mA	$P_o=7\text{mW}$
Operating voltage	V_{op}	-	2.2	2.5	V	$P_o=7\text{mW}$
Differential efficiency	η	0.7	0.9	1.2	mW/mA	$P_o=3-5\text{mW}$
Monitor current	I_m	0.1	0.2	0.3	mA	$P_o=7\text{mW}, V_{RD}=0\text{V}$
Parallel divergence angle	$\theta_{//}$	6	9	12	deg	
Perpendicular divergence angle	θ_{\perp}	25	28	32	deg	
Parallel FFP deviation angle	$\Delta\theta_{//}$	-2	0	+2	deg	$P_o=7\text{mW}$
Perpendicular FFP deviation angle	$\Delta\theta_{\perp}$	-2	0	+2	deg	
Emission point accuracy	$\Delta x\Delta y\Delta z$	-80	0	+80	um	

• Precautions

1. Do not operate the device above the maximum rating condition, even momentarily. It may cause unexpected permanent damage to the device.
2. Semiconductor laser device is very sensitive to electrostatic discharge. High voltage spike current may change the characteristics of the device, or malfunction at any time during its service period. Therefore, proper measures for preventing electrostatic discharge are strongly recommended.
3. Effective heat sink can help the device operates under a more relax condition; as a result, a more stable characteristics and better reliability can be achieved. So it is recommended that always apply proper heat sink before the device is operating.
4. Do not look into the laser beam directly by bare eyes. The laser beam may cause severe damage to human eyes.

* For reference only. Contents above are subject to change without notice.

AlGaInP Visible Laser Diode

ADL-65075TR/L

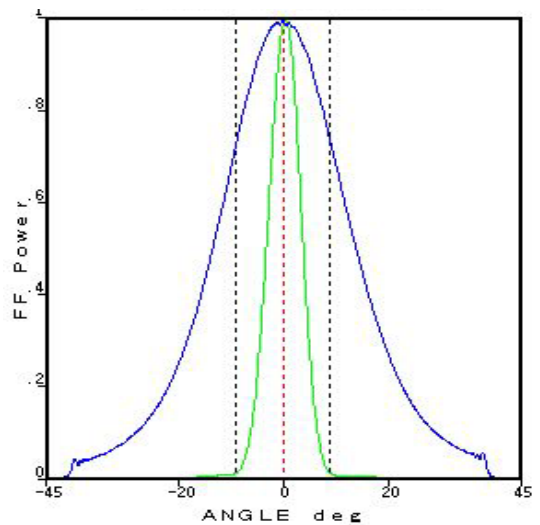
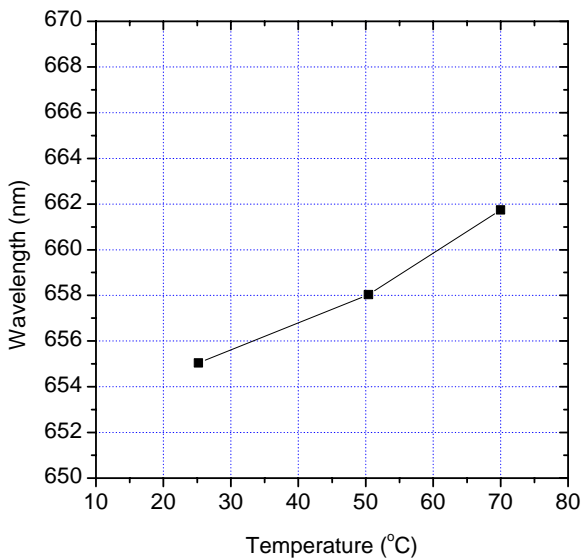
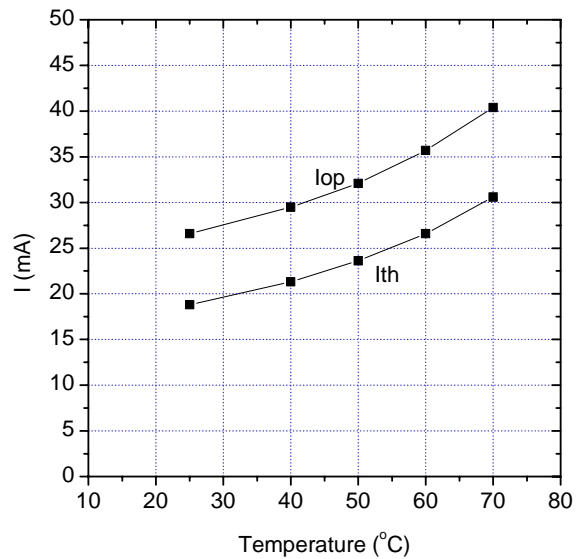
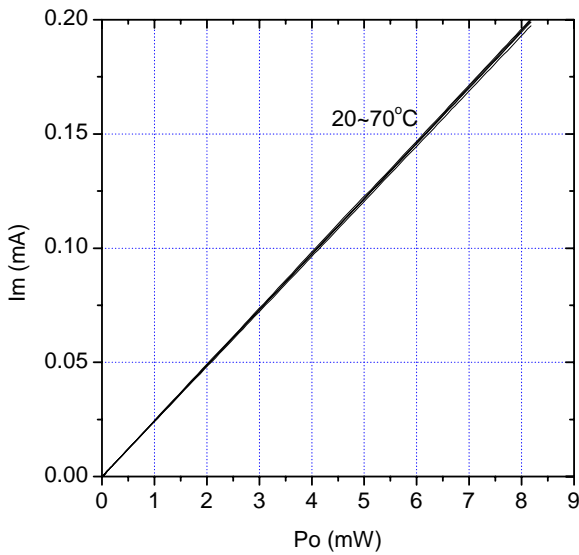
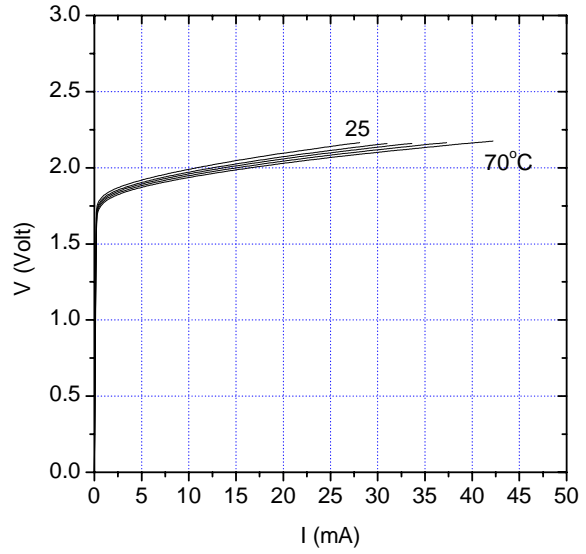
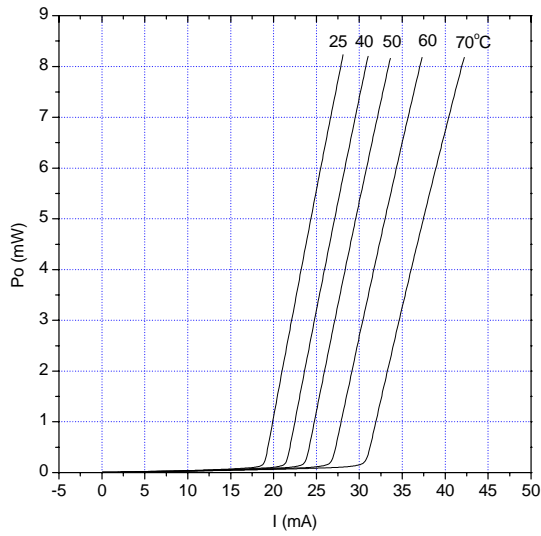

* For reference only. Contents above are subject to change without notice.