

Star-Delta Starters, Open Type Version

Protection by Thermal O/L Relay

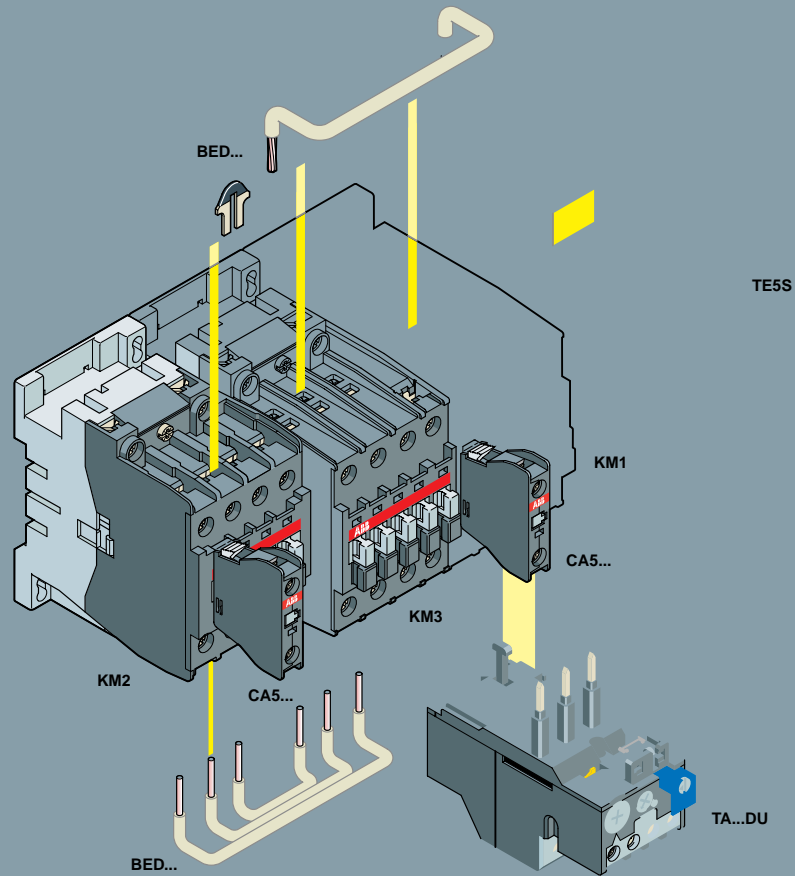

YKA...-30 version

Starters with electrical interlock

>> YKA...-30 Star-delta starters	page 2/1
>> Star-delta starters in kit form	page 2/8

Starters with mechanical and electrical interlock

>> YKA...-30E Star-delta starters	page 2/10
>> Star-delta starters in kit form	page 2/16

YKA ..-30, YDA ..-30 Star-Delta Starters Open Type Version Protection by Thermal O/L Relay

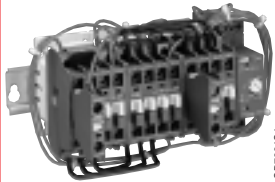
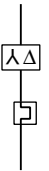

YKA 16-30

SB7634

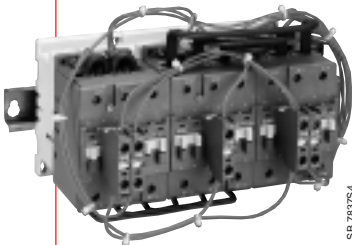

YKA 75-30

SB 7637S4



YDA 95-30

YDA95-30

Application

Starters for the control of three-phase asynchronous motors:

- up to an operational voltage of 690 V, 50 or 60 Hz,
- in compliance with standard IEC 947-4-1,
- air temperature close to contactors $\leq 55^{\circ}\text{C}$.

Maximum duty as per the chart below.

(Switching frequency/hour, according to acceleration time and load factor).

Respect of the following conditions enables utilization of the starter without excessive overheating of the connections or nuisance tripping of the thermal O/L relay.

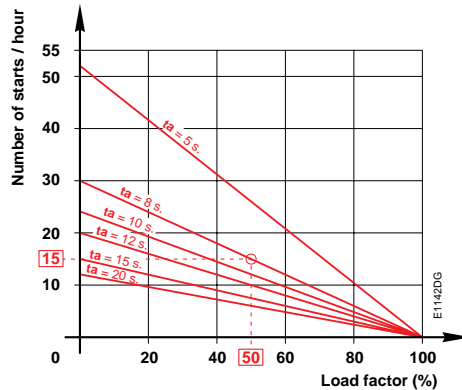

Example:

- Switching frequency = **15 starts/hr**
- Acceleration time "ta" = **7s** (use the 8 s curve)
- Maximum load factor = **50 %**

This corresponds to a 4-minute operating cycle (15 starts/hr) with 7 seconds acceleration, 2 minutes operation and 2 minutes rest.

Description

Each starter is delivered assembled, bare, cabled by us and contains:

- 1 KM1 "line" contactor,
- 1 KM2 "star" contactor,
- 1 KM3 "delta" contactor,
- the hold-in contacts,
- the electrical interlocking contacts for both the "star" and "delta" contactors,
- the space for the thermal O/L relay (direct mounting).

The thermal O/L relay must be supplied separately for you to mount and connect in the "delta" circuit. The **setting current** value of the thermal O/L relay must be equal to **motor rated current I_n x 0.58**; choose the thermal O/L relay with the right setting range for the setting current in question.

- 1 TE5S electronic timer with time lapse,
- the power circuit connections,
- the control circuit connections.

YKA 9 to YKA 26 : The assembly is mounted on a 35 x 7.5 mm mounting rail acc. to EN 50022

YKA 30 to YKA 75 : The assembly is mounted on a 35 x 15 mm mounting rail acc. to EN 50022

YKA 95 and YKA 110 : The assembly is supplied on a plate

- Degree of protection:
- IP20 for the main terminals of contactors A 9 ... A 40
 - IP10 for the main terminals of contactors A 50 ... A 110
 - IP20 for the control circuit terminals.

>> Ordering details page 2/2
>> Starters in kit form page 2/8
>> Wiring diagrams page 2/4

>> Accessories page 2/2
>> Dimensions page 2/5

YKA ...-30, YDA ...-30 Star-Delta Starters

Open Type Version

Protection by Thermal O/L Relay

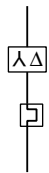

Ordering details - (Order the thermal O/L relay separately, see page 2/3)

Rated operat. current AC-3 400 V A	Power AC-3 4-pole motor - 50/60 Hz 380 V 400 V 415 V 690 V			Short-circuit protection * Type 1 co-ordination as per EN 60947-4-1 / IEC 947-4-1 380-400 V aM fuses gG fuses		Type State control voltage <input type="checkbox"/>	Order code to be completed with control voltage code <input type="checkbox"/>	Weight in kg Packing 1 piece
	kW	kW	kW	aM fuses	gG fuses			
15.5	7.5	7.5	5.5	16	25	YKA 9-30 <input type="checkbox"/>	1SBK 142 301R8 <input type="checkbox"/> 00	1.612
22	11	11	7.5	25	35	YKA 12-30 <input type="checkbox"/>	1SBK 162 301R8 <input type="checkbox"/> 00	1.612
30	15	15	11	32	50	YKA 16-30 <input type="checkbox"/>	1SBK 182 301R8 <input type="checkbox"/> 00	1.612
44	22	22	15	50	63	YKA 26-30 <input type="checkbox"/>	1SBK 242 301R8 <input type="checkbox"/> 00	2.119
50	25	25	18.5	63	100	YKA 30-30 <input type="checkbox"/>	1SBK 282 301R8 <input type="checkbox"/> 00	3.124
72	37	37	37	80	100	YKA 40-30 <input type="checkbox"/>	1SBK 322 301R8 <input type="checkbox"/> 00	3.135
85	45	45	45	100	125	YKA 50-30 <input type="checkbox"/>	1SBK 352 301R8 <input type="checkbox"/> 00	4.130
105	55	55	59	125	160	YKA 63-30 <input type="checkbox"/>	1SBK 372 301R8 <input type="checkbox"/> 00	4.136
119	63	70	63	160	200	YKA 75-30 <input type="checkbox"/>	1SBK 412 301R8 <input type="checkbox"/> 00	4.477
140	75	75	90	160	200	YDA 95-30 <input type="checkbox"/>	1SFK 432 302R8 <input type="checkbox"/> 00	7.000
170	90	100	132	200	250	YDA 110-30 <input type="checkbox"/>	1SFK 452 302R8 <input type="checkbox"/> 00	7.000

* For other short-circuit protection devices, please consult our co-ordination tables

Control circuit

Designed for "separate control supply":

The star-delta starters are delivered with their control circuit not connected to the power circuit.

The control circuit supply is to be connected according to the wiring diagram when putting the starter into service.

Please consult us for "direct control supply".

Control voltage code

Voltage V 50 Hz	Code	Control circuit
V 60 Hz	8 <input type="checkbox"/>	
24	24	1 must be connected
110	110 ... 120	4 - to a separate
110 ... 115	115 ... 120	9 supply
220 ... 230	230 ... 240	0 - or phase-to-phase
230 ... 240	240	8 - or phase-to-neutral
380 ... 400	400 ... 415	5
400 ... 415	415 ... 440	6
415 ... 440	440	7*

* Unsuitable for YKA 50-30 ... YKA 75-30 starters.

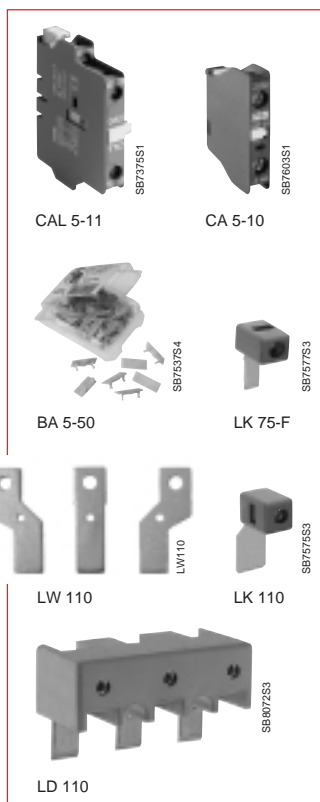

Ordering details, contactors accessories

Description	Type	Order code	Packing	Weight in kg
Function markers (50 pieces)	BA5-50	1 SBN 11 0000 R1000	box	0.017
1 x "N.O." auxiliary contact block	CA5-10	1 SBN 01 0010 R1010	10	0.014
1 x "N.C." auxiliary contact block	CA5-01	1 SBN 01 0010 R1001	10	0.014
"N.O."+"N.C." side-mnted cont. blk	CAL5-11	1 SBN 01 0020 R1011	2	0.050
Control lead terminals (A 50 ... A 75) Right/left connection	LK 75-L	1 SBN 07 3552 R1003	2	0.006
Front connection	LK 75-F	1 SBN 07 3552 R1002	2	0.006
Control lead terminals (A 95, A 110) Right/left connection	LK 110	1 SFN 07 4352 R1000	2	0.010
Add. terminal block (A 95 / A 110)	LD 110	1 SFN 07 4308 R1000	1	0.150
Terminal enlargement pieces (set of 3 bars) for A 95 / A 110	LW110	1 SFN 07 4307 R1000	1	0.100

>> Starters in kit form page 2/8
>> Wiring diagrams page 2/4

>> Thermal O/L relay page 2/3
>> Dimensions page 2/5

YKA ..-30, YDA ..-30 Star-Delta Starters Open Type Version Protection by Thermal O/L Relay

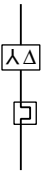

2

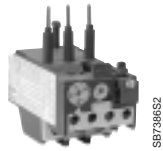

TA 25 DU

SB7398S2

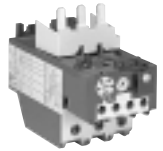

TA 42 DU

SB7398S3

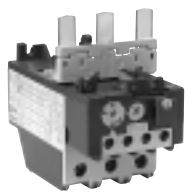

TA 75 DU

SB77387S2

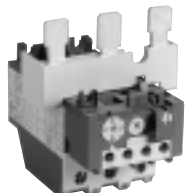

TA 80 DU

SB7398S3

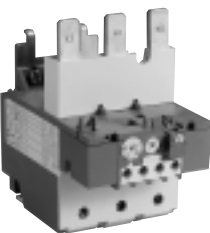

TA 110 DU

SB7398S4

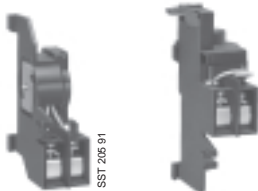

DS 25 A

DR 25 A

SST 205 91

SST 204 91

Coil voltage code for DS 25-A/DR 25-A

Voltage (V) 50/60 Hz	Coil voltage code	<input type="checkbox"/>
24	1	
48	2	
110	3	
220/380	5	
500	6	

Ordering details, thermal O/L relay

Starter	Setting range (1)		Type	Order code	Weight in kg Packing 1 piece
	A	... A			
YKA 9-30 to YKA 30-30	0.1 ... 0.16 0.16 ... 0.25 0.25 ... 0.4	0.16 ... 0.25 0.25 ... 0.4 0.4 ... 0.63	TA 25 DU 0.16 TA 25 DU 0.25 TA 25 DU 0.4	1SAZ 21 1201 R1005 1SAZ 21 1201 R1009 1SAZ 21 1201 R1013	0.150 0.150 0.150
	0.4 ... 0.63 0.63 ... 1.0 1.0 ... 1.4 1.3 ... 1.8 1.7 ... 2.4 2.2 ... 3.1	0.63 ... 1.0 1.0 ... 1.4 1.4 ... 1.8 1.8 ... 2.4 2.4 ... 3.1 3.1 ... 4.0	TA 25 DU 0.63 TA 25 DU 1.0 TA 25 DU 1.4 TA 25 DU 1.8 TA 25 DU 2.4 TA 25 DU 3.1	1SAZ 21 1201 R1017 1SAZ 21 1201 R1021 1SAZ 21 1201 R1023 1SAZ 21 1201 R1025 1SAZ 21 1201 R1028 1SAZ 21 1201 R1031	0.150 0.150 0.150 0.150 0.150 0.150
	2.8 ... 4.0 3.5 ... 5.0 4.5 ... 6.5 6.0 ... 8.5 7.5 ... 11 10 ... 14 13 ... 19 18 ... 25 24 ... 32	4.0 ... 5.0 5.0 ... 6.5 6.5 ... 8.5 8.5 ... 11 11 ... 14 14 ... 19 19 ... 25 25 ... 32	TA 25 DU 4.0 TA 25 DU 5.0 TA 25 DU 6.5 TA 25 DU 8.5 TA 25 DU 11 TA 25 DU 14 TA 25 DU 19 TA 25 DU 25 TA 25 DU 32	1SAZ 21 1201 R1033 1SAZ 21 1201 R1035 1SAZ 21 1201 R1038 1SAZ 21 1201 R1040 1SAZ 21 1201 R1043 1SAZ 21 1201 R1045 1SAZ 21 1201 R1047 1SAZ 21 1201 R1051 1SAZ 21 1201 R1053	0.150 0.150 0.150 0.150 0.150 0.150 0.150 0.150 0.170
YKA 40-30	18 ... 25 22 ... 32 29 ... 42	25 ... 32 32 ... 42 42 ... 42	TA 42 DU 25 TA 42 DU 32 TA 42 DU 42	1SAZ 31 1201 R1001 1SAZ 31 1201 R1002 1SAZ 31 1201 R1003	0.330 0.330 0.330
YKA 50-30 to YKA 75-30	18 ... 25 22 ... 32 29 ... 42	25 ... 32 32 ... 42 42 ... 42	TA 75 DU 25 TA 75 DU 32 TA 75 DU 42	1SAZ 32 1201 R1001 1SAZ 32 1201 R1002 1SAZ 32 1201 R1003	0.330 0.330 0.330
	36 ... 52 45 ... 63 60 ... 80	52 ... 63 63 ... 80 80 ... 80	TA 75 DU 52 TA 75 DU 63 TA 75 DU 80	1SAZ 32 1201 R1004 1SAZ 32 1201 R1005 1SAZ 32 1201 R1006	0.330 0.330 0.330
YKA -95-30 and YKA 110-30	29 ... 42 36 ... 52 45 ... 63 60 ... 80	42 ... 52 52 ... 63 63 ... 80 80 ... 80	TA 80 DU 42 TA 80 DU 52 TA 80 DU 63 TA 80 DU 80	1SAZ 33 1201 R1003 1SAZ 33 1201 R1004 1SAZ 33 1201 R1005 1SAZ 33 1201 R1006	0.360 0.360 0.360 0.360
YKA 95-30 and YKA 110-30	65 ... 90 80 ... 110	90 ... 110 110 ... 110	TA 110 DU 90 TA 110 DU 110	1SAZ 41 1201 R1001 1SAZ 41 1201 R1002	0.750 0.750

(1) The setting current value is the motor rated current I_n x 0.58

Example: For a motor rated current of 30 A, the setting current will be $30 \text{ A} \times 0.58 = 17.4 \text{ A}$.

Choose the thermal O/L relay TA 25 DU 19 - setting range 13 ... 19 A.

Ordering details, thermal O/L relay accessories

Description	Type	Order code	Pack- ing	Weight in kg
	State control voltage <input type="checkbox"/>	to be completed with control voltage code <input type="checkbox"/>		
Function markers (50 pieces)	BA5-50	1 SBN 11 0000 R1000	box	0.017
Remote tripping coil for TA 25 DU	DS 25-A- <input type="checkbox"/>	1 SAZ 20 1501 R000 <input type="checkbox"/>	1	0.100
Remote resetting coil for TA 25 DU	DR 25-A- <input type="checkbox"/>	1 SAZ 20 1504 R000 <input type="checkbox"/>	1	0.100

YKA ...-30, YDA ...-30 Star-Delta Starters

Open Type Version

Protection by Thermal O/L Relay

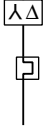

Wiring Diagrams

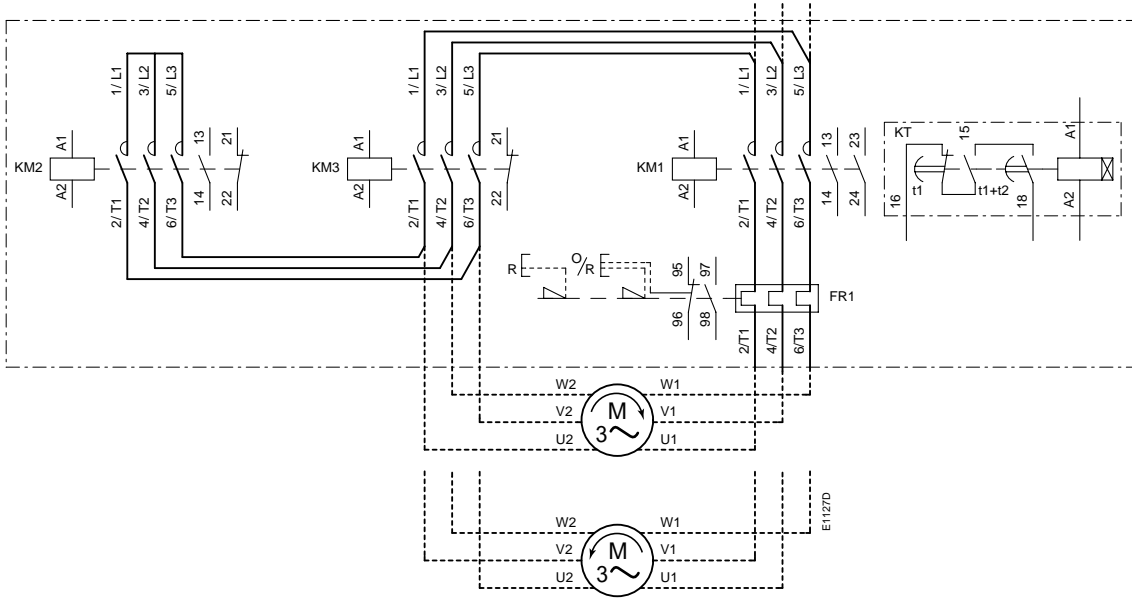

Power Circuit

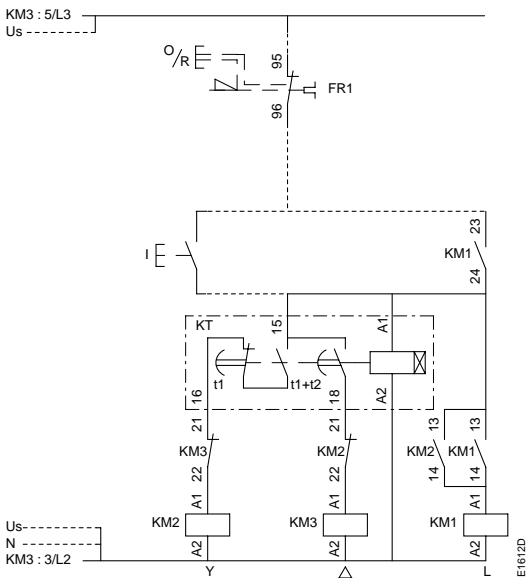

Local Control

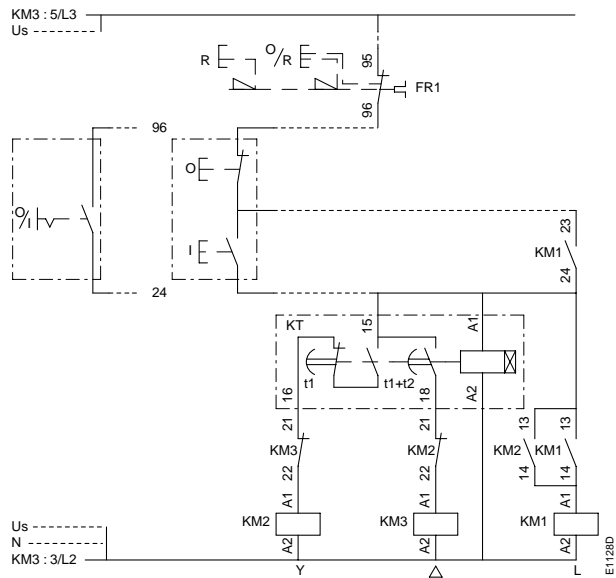

Remote Control

YKA ..-30, YDA ..-30 Star-Delta Starters

Open Type Version

Protection by Thermal O/L Relay



2

Dimensions (in mm)

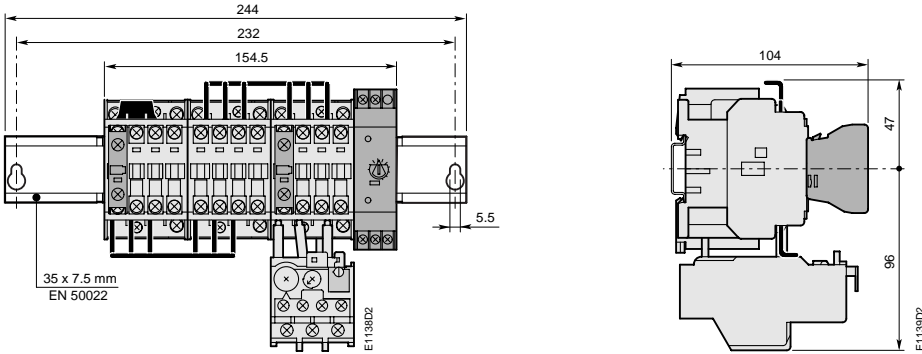

YKA 9-30 ... YKA 16-30 + TA 25

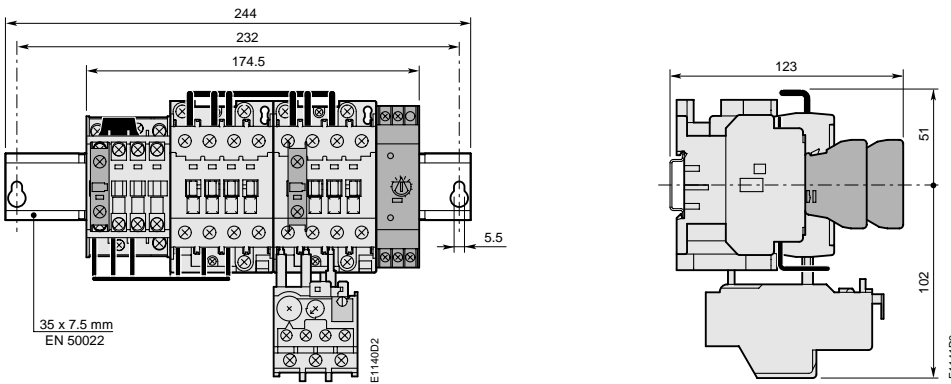

YKA 26-30 + TA 25

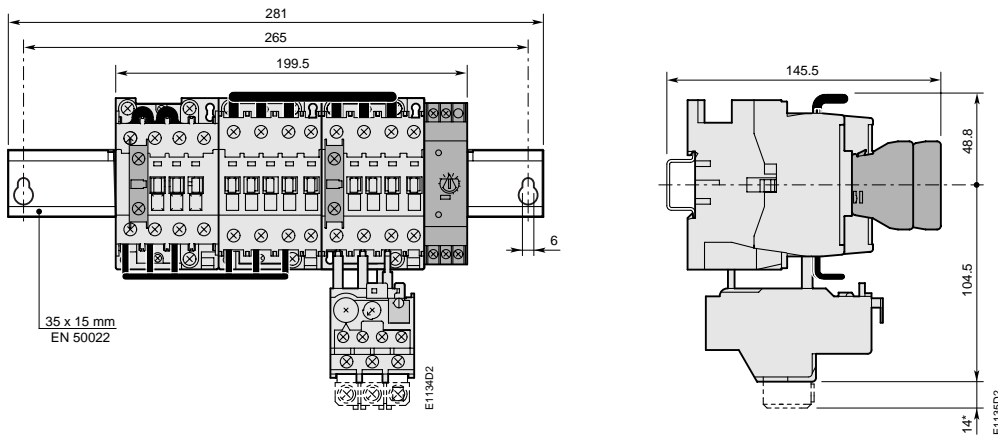

YKA 30-30 + TA 25

* for TA 25 DU 32 only

YKA ...-30, YDA ...-30 Star-Delta Starters

Open Type Version

Protection by Thermal O/L Relay

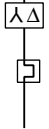

Dimensions (in mm)

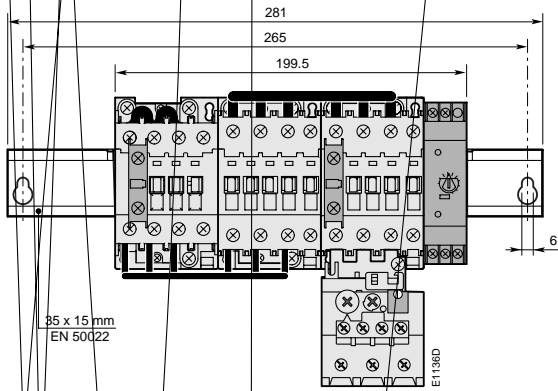

YKA 40-30 + TA 42

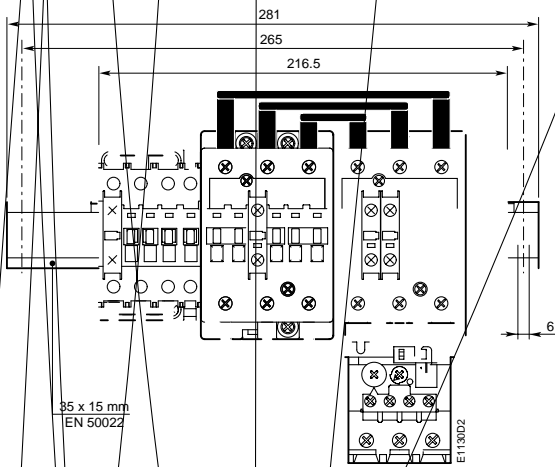

YKA 50-30 ... YKA 63-30 + TA 75

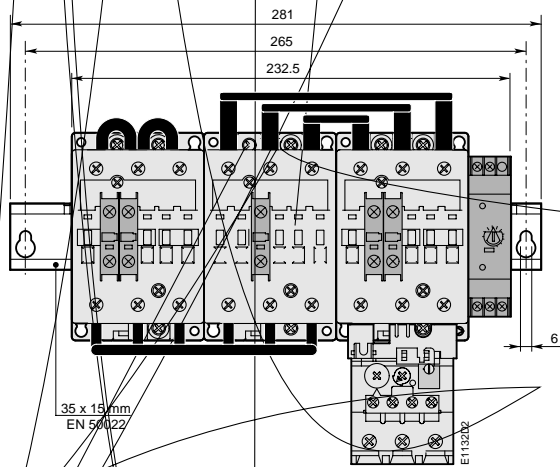

YKA 75-30 + TA 75

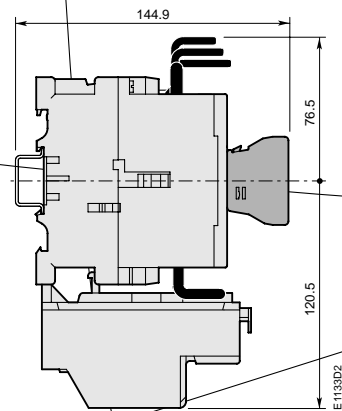
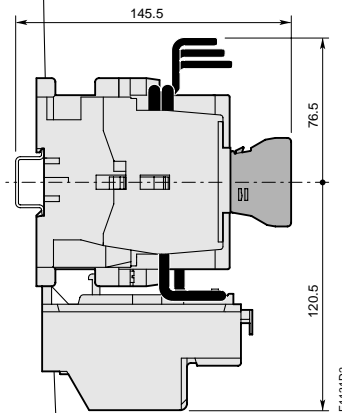
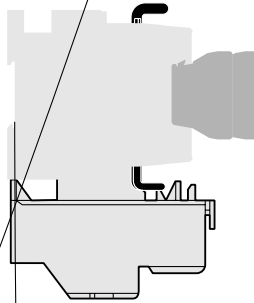

YKA ..-30, YDA ..-30 Star-Delta Starters Open Type Version Protection by Thermal O/L Relay



Dimensions (in mm)

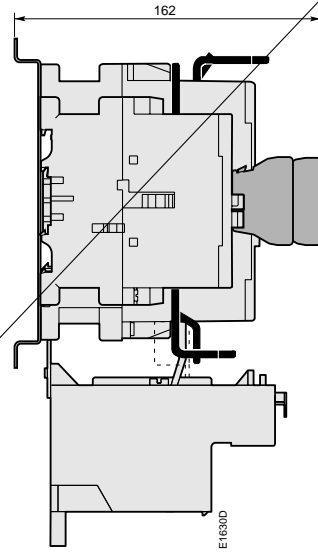
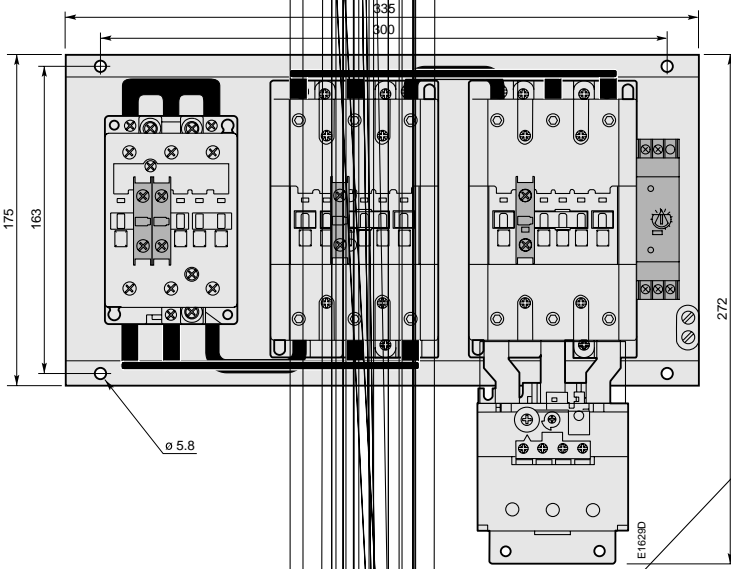

YDA 95-30 + TA 110

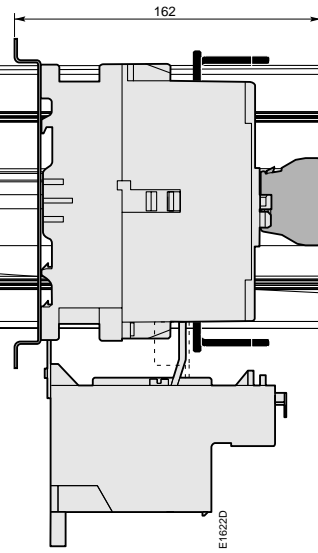
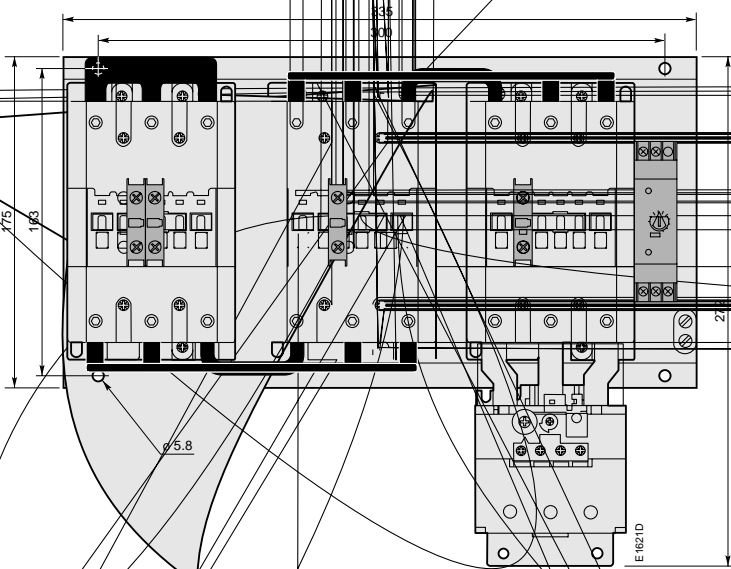

YDA 110-30 + TA 110

Star-Delta Starters, in Kit Form

Open Type Version

Protection by Thermal O/L Relay

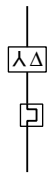

Components for starters in kit form (ordering details on next page)

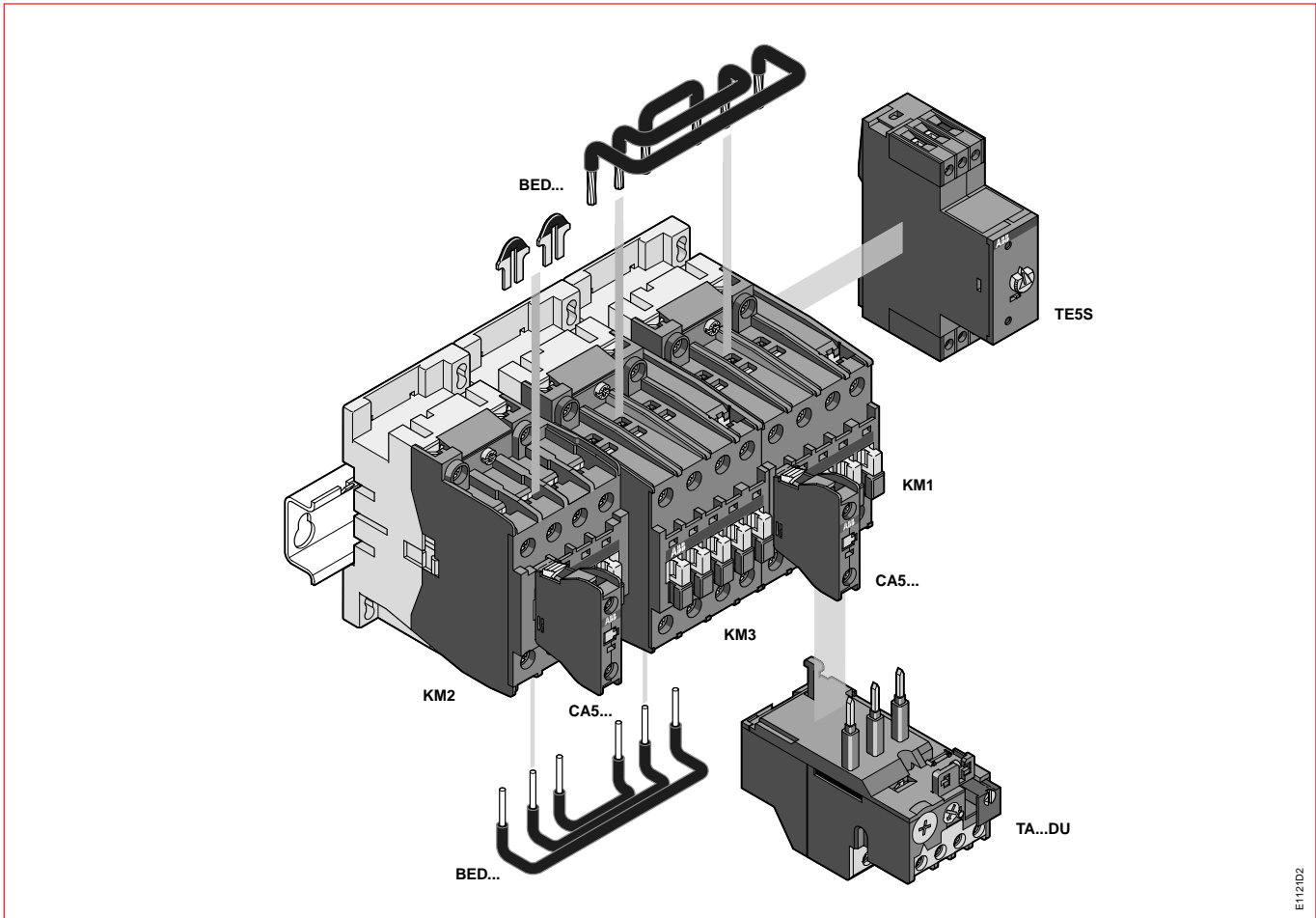

E1121D2

Details of power connections

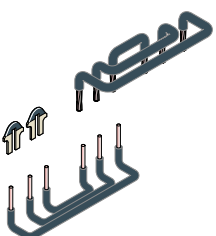
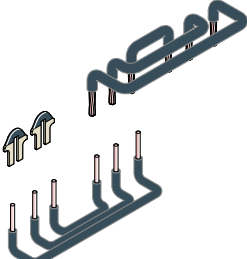
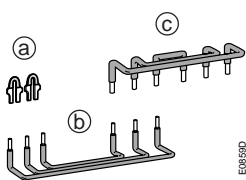
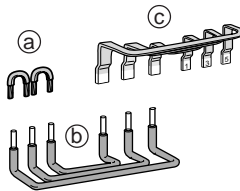
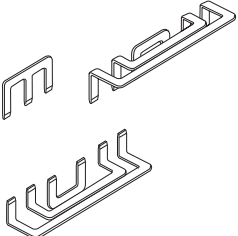
BED 16-1	BED 26-1	BED 40-1	BED 50-1 / BED 75-1	BED 95 / BED 110
				
2.5 mm² cable insulated rigid, solid copper	4 mm² cable insulated rigid, solid copper	(a) + (b) 4 mm² cable (c) 10 mm² cable insulated rigid stranded copper	(a) 16 mm² cable (b) 6 mm² cable insulated rigid stranded copper (c) 8 x 3 mm bar insulated copper	12 x 3 mm bar insulated copper

Star-Delta Starters, in Kit Form

Open Type Version

Protection by Thermal O/L Relay



2

Contactors and thermal O/L relay

Rated operat. current AC-3	Power AC-3 4-pole motor 50/60 Hz		Line contactor	△ Contactor	△ Contactor	Thermal O/L relay (1) FR1 (see page 2/3) Type Order code	Required accessories (see table below) Reference letter
	Nominal voltage	kW	KM1	KM2	KM3		
A	V	kW	Type and state coil voltage : <input type="checkbox"/> <input type="checkbox"/>				
	Order code to be completed with coil voltage code : <input type="checkbox"/> (see page 2/2)						
15.5	380-400	7.5	A 9-30-10 <input type="checkbox"/>	A 9-30-01 <input type="checkbox"/>	A 9-30-01 <input type="checkbox"/>	TA 25 DU <input type="checkbox"/>	A
14	415	7.5	1SBL 14 1001 R8 <input type="checkbox"/> 10	1SBL 14 1001 R8 <input type="checkbox"/> 01	1SBL 14 1001 R8 <input type="checkbox"/> 01	1SAZ 21 1201 R10 <input type="checkbox"/> 00	
6.7	690	5.5					
22	380-400	11	A 12-30-10 <input type="checkbox"/>	A 9-30-01 <input type="checkbox"/>	A 12-30-01 <input type="checkbox"/>	TA 25 DU <input type="checkbox"/>	A
21	415	11	1SBL 16 1001 R8 <input type="checkbox"/> 10	1SBL 14 1001 R8 <input type="checkbox"/> 01	1SBL 16 1001 R8 <input type="checkbox"/> 01	1SAZ 21 1201 R10 <input type="checkbox"/> 00	
9	690	7.5					
30	380-400	15	A 16-30-10 <input type="checkbox"/>	A 12-30-01 <input type="checkbox"/>	A 16-30-01 <input type="checkbox"/>	TA 25 DU <input type="checkbox"/>	A
28	415	15	1SBL 18 1001 R8 <input type="checkbox"/> 10	1SBL 16 1001 R8 <input type="checkbox"/> 01	1SBL 18 1001 R8 <input type="checkbox"/> 01	1SAZ 21 1201 R10 <input type="checkbox"/> 00	
13	690	11					
44	380-400	22	A 26-30-10 <input type="checkbox"/>	A 16-30-01 <input type="checkbox"/>	A 26-30-01 <input type="checkbox"/>	TA 25 DU <input type="checkbox"/>	B
40	415	22	1SBL 24 1001 R8 <input type="checkbox"/> 10	1SBL 18 1001 R8 <input type="checkbox"/> 01	1SBL 24 1001 R8 <input type="checkbox"/> 01	1SAZ 21 1201 R10 <input type="checkbox"/> 00	
17.5	690	15					
50	380-400	25	A 30-30-10 <input type="checkbox"/>	A 26-30-01 <input type="checkbox"/>	A 30-30-01 <input type="checkbox"/>	TA 25 DU <input type="checkbox"/>	C
47	415	25	1SBL 28 1001 R8 <input type="checkbox"/> 10	1SBL 24 1001 R8 <input type="checkbox"/> 01	1SBL 28 1001 R8 <input type="checkbox"/> 01	1SAZ 21 1201 R10 <input type="checkbox"/> 00	
21	690	18.5					
72	380-400	37	A 40-30-10 <input type="checkbox"/>	A 26-30-01 <input type="checkbox"/>	A 40-30-01 <input type="checkbox"/>	TA 42 DU <input type="checkbox"/>	C
66	415	37	1SBL 32 1001 R8 <input type="checkbox"/> 10	1SBL 24 1001 R8 <input type="checkbox"/> 01	1SBL 32 1001 R8 <input type="checkbox"/> 01	1SAZ 31 1201 R10 <input type="checkbox"/> 00	
42	690	37					
85	380-400	45	A 50-30-00 <input type="checkbox"/>	A 30-30-01 <input type="checkbox"/>	A 50-30-00 <input type="checkbox"/>	TA 75 DU <input type="checkbox"/>	D
80	415	45	1SBL 35 1001 R8 <input type="checkbox"/> 00	1SBL 28 1001 R8 <input type="checkbox"/> 01	1SBL 35 1001 R8 <input type="checkbox"/> 00	1SAZ 32 1201 R10 <input type="checkbox"/> 00	
49	690	45					
105	380-400	55	A 63-30-00 <input type="checkbox"/>	A 40-30-01 <input type="checkbox"/>	A 63-30-00 <input type="checkbox"/>	TA 75 DU <input type="checkbox"/>	D
96	415	55	1SBL 37 1001 R8 <input type="checkbox"/> 00	1SBL 32 1001 R8 <input type="checkbox"/> 01	1SBL 37 1001 R8 <input type="checkbox"/> 00	1SAZ 32 1201 R10 <input type="checkbox"/> 00	
66	690	59					
119	380-400	63	A 75-30-00 <input type="checkbox"/>	A 50-30-00 <input type="checkbox"/>	A 75-30-00 <input type="checkbox"/>	TA 75 DU <input type="checkbox"/>	E
126	415	70	1SBL 41 1001 R8 <input type="checkbox"/> 00	1SBL 35 1001 R8 <input type="checkbox"/> 00	1SBL 41 1001 R8 <input type="checkbox"/> 00	1SAZ 32 1201 R10 <input type="checkbox"/> 00	
70	690	63					
140	380-400	75	A 95-30-00 <input type="checkbox"/>	A 75-30-00 <input type="checkbox"/>	A 95-30-00 <input type="checkbox"/>	TA 110 DU <input type="checkbox"/>	F
135	415	75	1SFL 43 1001 R8 <input type="checkbox"/> 00	1SBL 41 1001 R8 <input type="checkbox"/> 00	1SFL 43 1001 R8 <input type="checkbox"/> 00	1SAZ 41 1201 R10 <input type="checkbox"/> 00	
98	690	90					
170	380-400	90	A 110-30-00 <input type="checkbox"/>	A 95-30-00 <input type="checkbox"/>	A 110-30-00 <input type="checkbox"/>	TA 110 DU <input type="checkbox"/>	G
182	415	100	1SFL 45 1001 R8 <input type="checkbox"/> 00	1SFL 43 1001 R8 <input type="checkbox"/> 00	1SFL 45 1001 R8 <input type="checkbox"/> 00	1SAZ 41 1201 R10 <input type="checkbox"/> 00	
140	690	132					

(1) The setting current value is : motor rated current $I_n \times 0.58$.

Required accessories

Ref. letter	Connection set Type Order code	KM1 Aux. contacts Type Order code	KM2 Aux. Contacts Type Order code	KM3 Aux. Contacts Type Order code	Timer Type Order code	Plate Type Order code
A	BED 16-1 1SBN 08 1403 R1001					-
B	BED 26-1 1SBN 08 2403 R1001	CA 5-10 1SBN 01 0010 R1010	CA 5-10 1SBN 01 0010 R1010	-	According to the control voltage (50/60Hz)	-
C	BED 40-1 1SBN 08 2803 R1001				24 V TE5S-24 1SBN 02 0010 R1001	-
D	BED 50-1 1SBN 08 3503 R1001	2 x CA 5-10 1SBN 01 0010 R1010	CA 5-10 1SBN 01 0010 R1010	CA 5-01 1SBN 01 0010 R1001	110...120 V TE5S-120 1SBN 02 0010 R1002	-
E	BED 75-1 1SBN 08 4103 R1001				220...240 V TE5S-240 1SBN 02 0010 R1003	-
F	BED 95 1 SFN 08 4303 R1000	2 x CA 5-10 1SBN 01 0010 R1010	1 x CA 5-10 1SBN 01 0010 R1010	CA 5-01 1SBN 01 0010 R1001	380...440 V TE5S-440 1SBN 02 0010 R1004	PN110-41 1SFN 09 4303 R1000
G	BED 110 1 SFN 08 4503 R1000		1SBN 01 0010 R1001			PN110-41 1SFN 09 4303 R1000

YKA ..-30E Star-Delta Starters

Open Type Version, with Interlock

Protection by Thermal O/L Relay

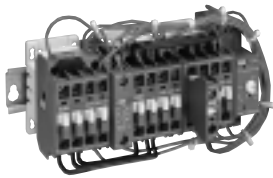
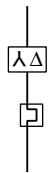

YKA 9-30 E

SB7827S4

Application

Starters for the control of three-phase asynchronous motors:

- in compliance with standard IEC 947-4-1,
- up to an operational voltage of 690 V, 50 or 60 Hz,
- air temperature close to contactors $\leq 55^{\circ}\text{C}$

Maximum duty as per the chart below.

(Switching frequency/hour, according to acceleration time and load factor).

Respect of the following conditions enables utilization of the starter without excessive overheating of the connections or nuisance tripping of the thermal O/L relay.

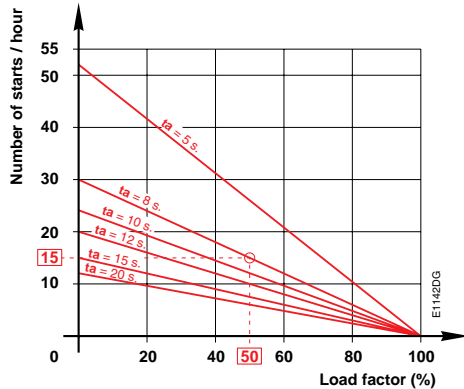

Example:

- Switching frequency = **15 starts/hr**
- Acceleration time "ta" = **7s** (use the 8 s curve)
- Maximum load factor = **50 %**

This corresponds to a 4-minute operating cycle (15 starts/hr) with 7 seconds acceleration, 2 minutes operation and 2 minutes rest.

Description

Each starter is delivered assembled, bare, cabled by us and contains:

- 1 KM1 "line" contactor,
- 1 KM2 "star" contactor,
- 1 KM3 "delta" contactor,
- the hold-in contacts,
- 1 "star" and "delta" contactor mechanical and electrical interlock device,
- the space for the thermal O/L relay (direct mounting).

The thermal O/L relay must be supplied separately for you to mount and connect in the "delta" circuit. The **setting current** value of the thermal O/L relay must be equal to **motor rated current I_n x 0.58**; choose the thermal O/L relay with the right setting range for the setting current in question.

- 1 TE5S electronic timer with time lapse,
- the power circuit connections,
- the control circuit connections.

The assembly is mounted on a mounting rail acc. to EN 50022:

- 35 x 7.5 mm for **YKA 9** to **YKA 26** types
- 35 x 15 mm for **YKA 30** to **YKA 75** types

- Degree of protection:
- IP20 for the main terminals of contactors A 9 ... A 40
 - IP10 for the main terminals of contactors A 50 ... A 75
 - IP20 for the control circuit terminals

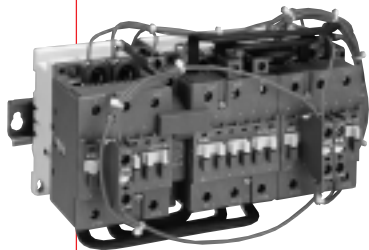

YKA 75-30 E

SB7828S4

>> Ordering details page 2/11
 >> Starters in kit form page 2/16
 >> Wiring diagrams page 2/13

>> Accessories page 2/12
 >> Dimensions page 2/14

YKA ..-30E Star-Delta Starters

Open Type Version, with Interlock

Protection by Thermal O/L Relay



2

Ordering details - (Order the thermal O/L relay separately, see page 2/12)

Rated operat. current AC-3 400 V A	Power AC-3 4-pole motor - 50/60 Hz 380 V 400 V 415 V 690 V			Short-circuit protection * Type 1 co-ordination as per EN 60947-4-1 / IEC 947-4-1 380-400 V aM fuses gG fuses		Type State control voltage <input type="checkbox"/>	Order code to be completed with control voltage code <input type="checkbox"/>	Weight in kg Packing 1 piece
	kW	kW	kW	aM	gG			
15.5	7.5	7.5	5.5	16	25	YKA 9-30E <input type="checkbox"/>	1SBK 142 501R8 <input type="checkbox"/> 00	1.655
22	11	11	7.5	25	35	YKA 12-30E <input type="checkbox"/>	1SBK 162 501R8 <input type="checkbox"/> 00	1.655
30	15	15	11	32	50	YKA 16-30E <input type="checkbox"/>	1SBK 182 501R8 <input type="checkbox"/> 00	1.655
44	22	22	15	50	63	YKA 26-30E <input type="checkbox"/>	1SBK 242 501R8 <input type="checkbox"/> 00	2.162
50	25	25	18.5	63	100	YKA 30-30E <input type="checkbox"/>	1SBK 282 501R8 <input type="checkbox"/> 00	3.167
72	37	37	37	80	100	YKA 40-30E <input type="checkbox"/>	1SBK 322 501R8 <input type="checkbox"/> 00	3.178
85	45	45	45	100	125	YKA 50-30E <input type="checkbox"/>	1SBK 352 501R8 <input type="checkbox"/> 00	4.197
105	55	55	59	125	160	YKA 63-30E <input type="checkbox"/>	1SBK 372 501R8 <input type="checkbox"/> 00	4.203
119	63	70	63	160	200	YKA 75-30E <input type="checkbox"/>	1SBK 412 501R8 <input type="checkbox"/> 00	4.544

* For other short-circuit protection devices, please consult our co-ordination tables

Control circuit

Designed for "separate control supply":

The star-delta starters are delivered with their control circuit not connected to the power circuit.

The control circuit supply is to be connected according to the wiring diagram when putting the starter into service.

Please consult us for "direct control supply".

Control voltage code

Voltage		Code	Control circuit
V 50 Hz	V 60 Hz	8 <input type="checkbox"/>	
24	24	1	must be connected
110	110 ... 120	4	- to a separate
110 ... 115	115 ... 120	9	supply
220 ... 230	230 ... 240	0	- or phase-to-phase
230 ... 240	240	8	- or phase-to-neutral
380 ... 400	400 ... 415	5	
400 ... 415	415 ... 440	6	
415 ... 440	440	7*	

* Unsuitable for YKA 50-30E ... YKA 75-30E starters.

YKA ..-30E Star-Delta Starters

Open Type Version, with Interlock Protection by Thermal O/L Relay

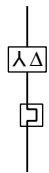

Ordering details, thermal O/L relay

Starter	Setting range (1)		Type	Order code	Weight in kg Packing 1 piece
	A	... A			
YKA 9-30E	0.1	... 0.16	TA 25 DU 0.16	1SAZ 21 1201 R1005	0.150
to	0.16	... 0.25	TA 25 DU 0.25	1SAZ 21 1201 R1009	0.150
YKA 30-30E	0.25	... 0.4	TA 25 DU 0.4	1SAZ 21 1201 R1013	0.150
	0.4	... 0.63	TA 25 DU 0.63	1SAZ 21 1201 R1017	0.150
	0.63	... 1.0	TA 25 DU 1.0	1SAZ 21 1201 R1021	0.150
	1.0	... 1.4	TA 25 DU 1.4	1SAZ 21 1201 R1023	0.150
	1.3	... 1.8	TA 25 DU 1.8	1SAZ 21 1201 R1025	0.150
	1.7	... 2.4	TA 25 DU 2.4	1SAZ 21 1201 R1028	0.150
	2.2	... 3.1	TA 25 DU 3.1	1SAZ 21 1201 R1031	0.150
	2.8	... 4.0	TA 25 DU 4.0	1SAZ 21 1201 R1033	0.150
	3.5	... 5.0	TA 25 DU 5.0	1SAZ 21 1201 R1035	0.150
	4.5	... 6.5	TA 25 DU 6.5	1SAZ 21 1201 R1038	0.150
	6.0	... 8.5	TA 25 DU 8.5	1SAZ 21 1201 R1040	0.150
	7.5	... 11	TA 25 DU 11	1SAZ 21 1201 R1043	0.150
	10	... 14	TA 25 DU 14	1SAZ 21 1201 R1045	0.150
	13	... 19	TA 25 DU 19	1SAZ 21 1201 R1047	0.150
	18	... 25	TA 25 DU 25	1SAZ 21 1201 R1051	0.150
	24	... 32	TA 25 DU 32	1SAZ 21 1201 R1053	0.170
YKA 40-30E	18	... 25	TA 42 DU 25	1SAZ 31 1201 R1001	0.330
	22	... 32	TA 42 DU 32	1SAZ 31 1201 R1002	0.330
	29	... 42	TA 42 DU 42	1SAZ 31 1201 R1003	0.330
YKA 50-30E	18	... 25	TA 75 DU 25	1SAZ 32 1201 R1001	0.330
to	22	... 32	TA 75 DU 32	1SAZ 32 1201 R1002	0.330
YKA 75-30E	29	... 42	TA 75 DU 42	1SAZ 32 1201 R1003	0.330
	36	... 52	TA 75 DU 52	1SAZ 32 1201 R1004	0.330
	45	... 63	TA 75 DU 63	1SAZ 32 1201 R1005	0.330
	60	... 80	TA 75 DU 80	1SAZ 32 1201 R1006	0.330

(1) The **setting current** value is the motor rated current I_n x 0.58

Example: For a motor rated current of 30 A, the **setting current** will be $30 \text{ A} \times 0.58 = 17.4 \text{ A}$.

Choose the thermal O/L relay **TA 25 DU 19** - setting range **13 ... 19 A**.

Ordering details, contactors accessories

Description	Type	Order code	Pack- ing	Weight in kg
Function markers (50 pieces)	BA5-50	1 SBN 11 0000 R1000	box	0.017
1 x "N.O." auxiliary contact block	CA5-10	1 SBN 01 0010 R1010	10	0.014
1 x "N.C." auxiliary contact block	CA5-01	1 SBN 01 0010 R1001	10	0.014
"N.O."+"N.C." side-mnted cont. blk	CAL5-11	1 SBN 01 0020 R1011	2	0.050
Control lead terminals (A 50 ... A 75)				
Right/left connection	LK 75-L	1 SBN 07 3552 R1003	2	0.006
Front connection	LK 75-F	1 SBN 07 3552 R1002	2	0.006

Ordering details, thermal O/L relay accessories

Description	Type	Order code	Pack- ing	Weight in kg
Function markers (50 pieces)	BA5-50	1 SBN 11 0000 R1000	box	0.017
Remote tripping coil for TA 25 DU	DS 25-A- <input type="checkbox"/>	1 SAZ 20 1501 R000 <input type="checkbox"/>	1	0.100
Remote resetting coil for TA 25 DU	DR 25-A- <input type="checkbox"/>	1 SAZ 20 1504 R000 <input type="checkbox"/>	1	0.100

Coil voltage code for DS 25-A/DR 25-A

Voltage (V) 50/60 Hz	Coil voltage code <input type="checkbox"/>
24	1
48	2
110	3
220/380	5
500	6

YKA ..-30E Star-Delta Starters

Open Type Version, with Interlock

Protection by Thermal O/L Relay



2

Wiring diagrams

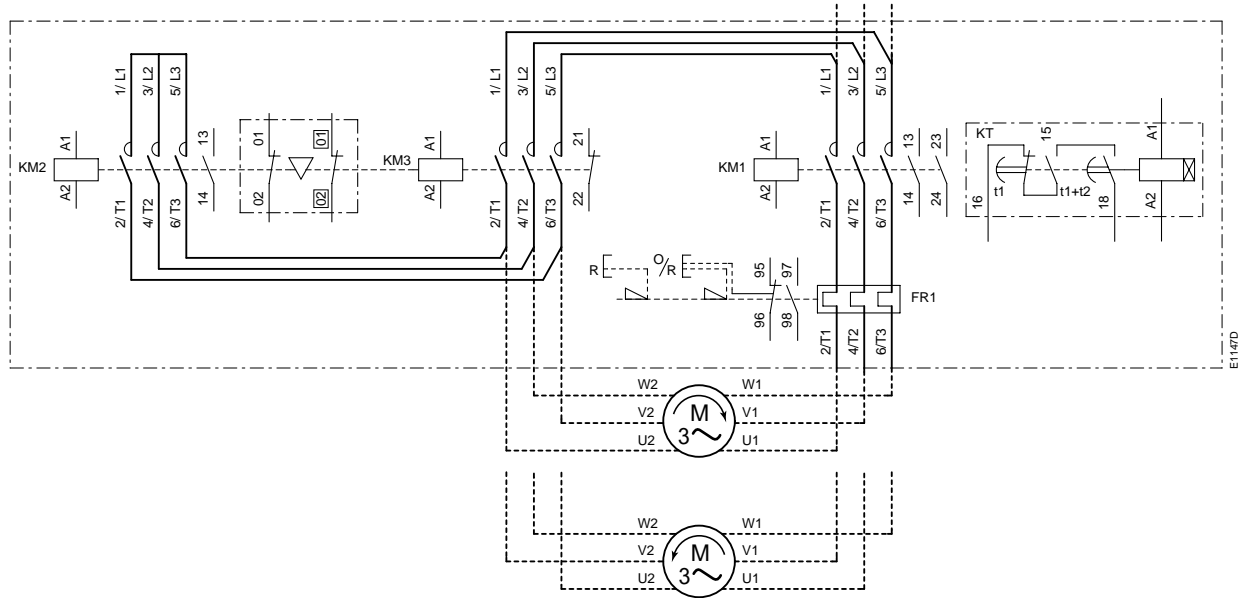

Power circuit

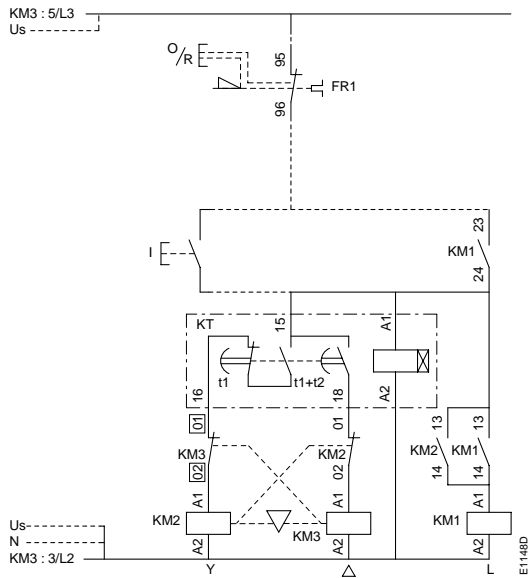

Local control

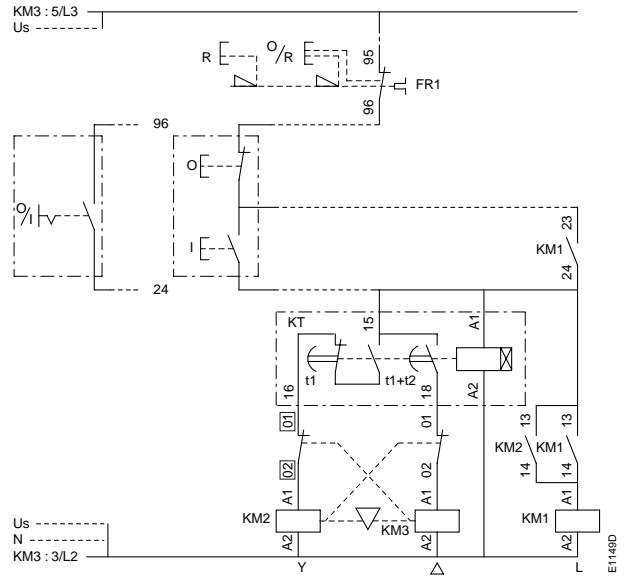

Remote control

YKA ..-30E Star-Delta Starters

Open Type Version, with Interlock

Protection by Thermal O/L Relay



Dimensions (in mm)

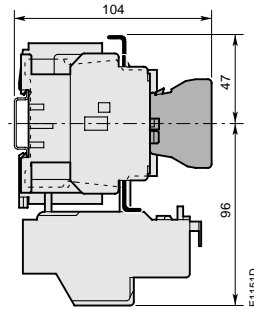
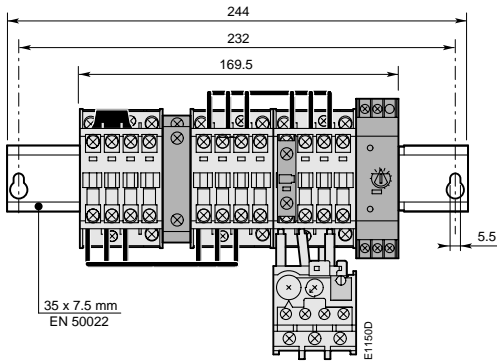

YKA 9-30E ... YKA 16-30E + TA 25

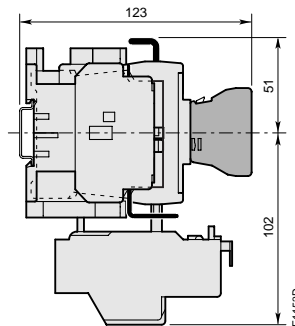
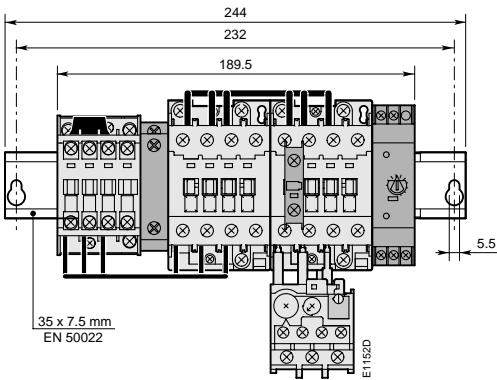

YKA 26-30E + TA 25

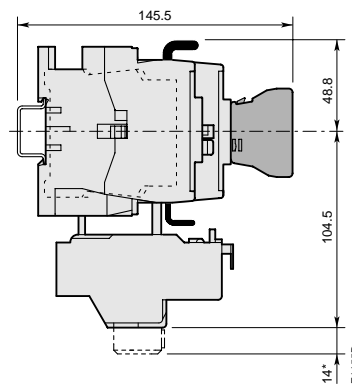
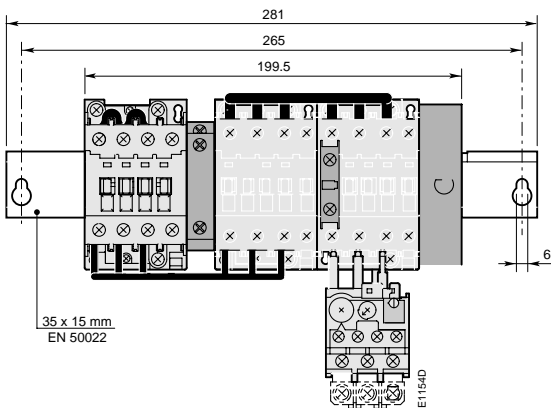

YKA 30-30E + TA 25

* for TA 25 DU 32 only

YKA ..-30E Star-Delta Starters

Open Type Version, with Interlock

Protection by Thermal O/L Relay

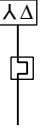

2

Dimensions (in mm)

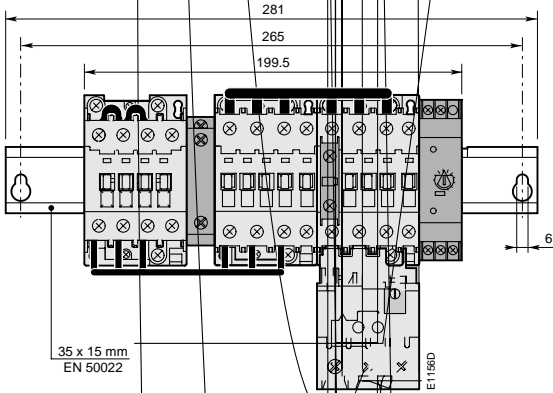

YKA 40-30E + TA 42

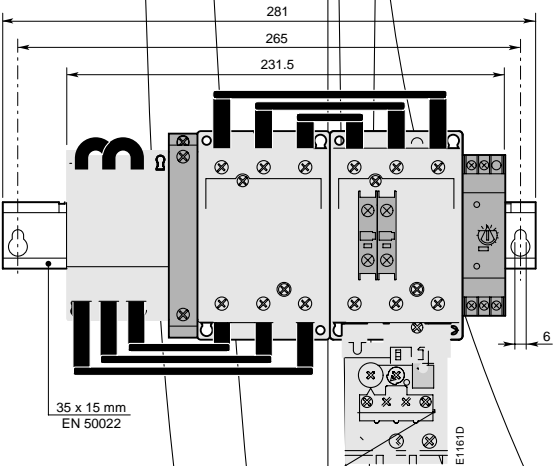
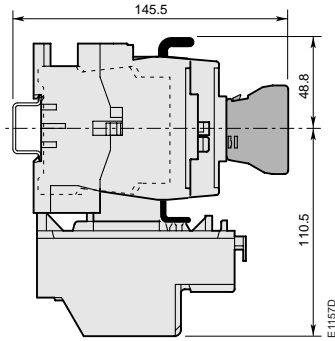

YKA 50-30E ... YKA 63-30E + TA 75

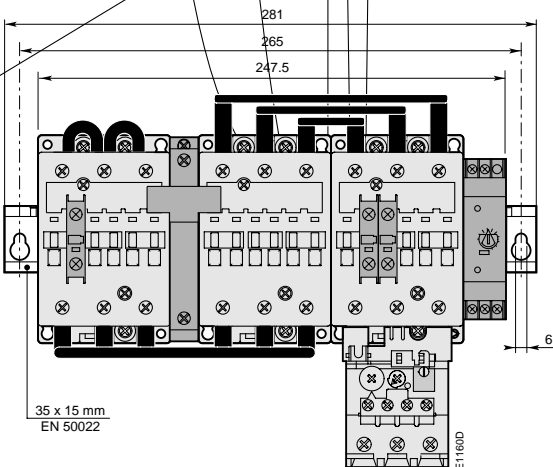
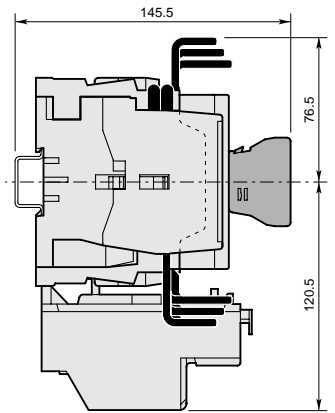

YKA 75-30E + TA 75

