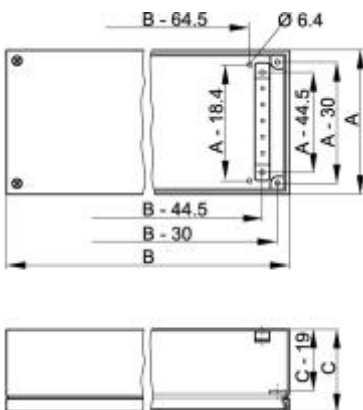

**Article number: 12405-021**

- Type of protection IP 66
- Pre-assembled and wired before installation with support rails
- Installation of mounting plate instead of mounting rail possible
- Screwed cover

Delivery quantity: assembled

Item	Qty	Description
1	1	Basic case, St, 1.4 mm, RAL 7032
2	1	Top cover, St, 1.4 mm, RAL 7032, with sealing
3	2	Assembly rail, St, 3.4 mm, zinc-plated
4	1	Assembly kit for internal configuration

Technical data:

A	B	C	Weight
150 mm	300 mm	120 mm	1,1 kg

Technical data:

A = height, B = width, C = depth

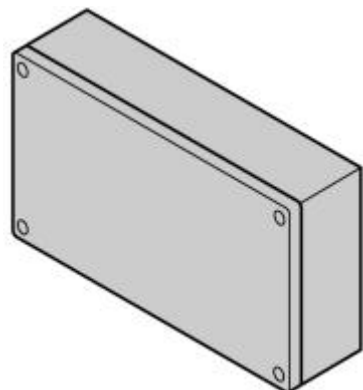
**Accessories:**

12405-120	Wall mounting bracket
32405-025	Mounting plate
62405-003	Support rail TS 35/7.5 (EN 50022)
62405-012	Support rail TS 35/15 (EN 50022)
21101-836	Earthing kit

Notes:

- Other sizes available on request