

Soft Ferrites

Multilayer suppressors

MULTILAYER SUPPRESSORS

Multilayer suppressors are a powerful solution for EMI/RFI attenuation for electronic equipment. Supplied in four standard sizes (0603, 0805, 1206 and 1806), they have impedances between 30 and 1 000 Ω at 100 MHz.

When installed in series with signal and/or power circuits, high frequency noise is suppressed. There is no need for ground termination, which makes these devices very suitable for circuits with difficult ground. Typical suppression frequencies range from 10 MHz to 1 000 MHz and rated currents are between 0.1 and 0.6 A.

Multilayer suppressors are specially designed to reduce noise in low impedance circuits while keeping the signal free from distortion. This is because at the interfering frequencies these components behave as a resistor. The high frequency noise is converted into heat rather than reflected to the source. This dissipation prevents ringing and parasitic oscillations.

These characteristics can be used for many different purposes:

- Absorption of generated noise.
- Filtering and wave-shape correction of digital signals from high speed clock oscillators.
- Prevention of high frequency interference entering circuit electronics.

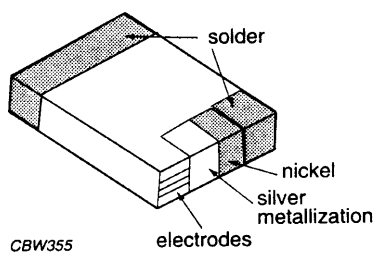

Fig.1 Structure of electrodes.

Product construction

The use of silver for electrodes and terminations in multilayer suppressors ensures high electrical conductivity, which minimizes heat generation and crosstalk.

The internal construction can be single layer or multilayer, depending on impedance requirements. Single layer products have a meander design and are suitable for lower impedances, while multilayer types have alternating layers of ferrite and conductor stacked up to achieve higher impedance levels.

The terminal electrode forms a conductive connection to the circuit. It is formed by three layers:

- Silver: for good conductivity
- Nickel: to protect silver termination against leaching
- Tin-lead: applied to ensure good solderability.

The products are suitable for both reflow and wave soldering.

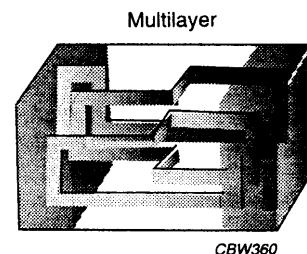
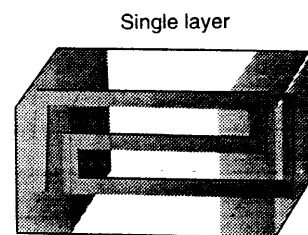

Fig.2 Internal structure of multilayer suppressors.

Soft Ferrites

Multilayer suppressors

TYPE NUMBER STRUCTURE

Type numbers for these products consist of the following:

- Product type
- Size
- Material
- Impedance.

Product type

MLS: multilayer suppressor.

Size

0603: 1.6 × 0.80 mm

0805: 2.0 × 1.25 mm

1206: 3.2 × 1.60 mm

1806: 4.5 × 1.60 mm.

Material

4S4

4S7

Impedance value

Expressed in ohms (Ω)

First two digits are significant figures

Last digit is the number of zeros to follow.

EXAMPLES

600: 60 Ω

101: 100 Ω

121: 120 Ω

151: 150 Ω

301: 300 Ω

102: 1000 Ω

Example of the ordering code: MLS0603-4S7-600

TYPE	SIZE	MATERIAL	IMPEDANCE
MLS	0603	4S7	60

Standard products are delivered taped on reel and have a tolerance on impedance of 25%. For different specifications a fifth group is added to the type number.

Soft Ferrites

MLS0603

MULTILAYER SUPPRESSORS MLS0603

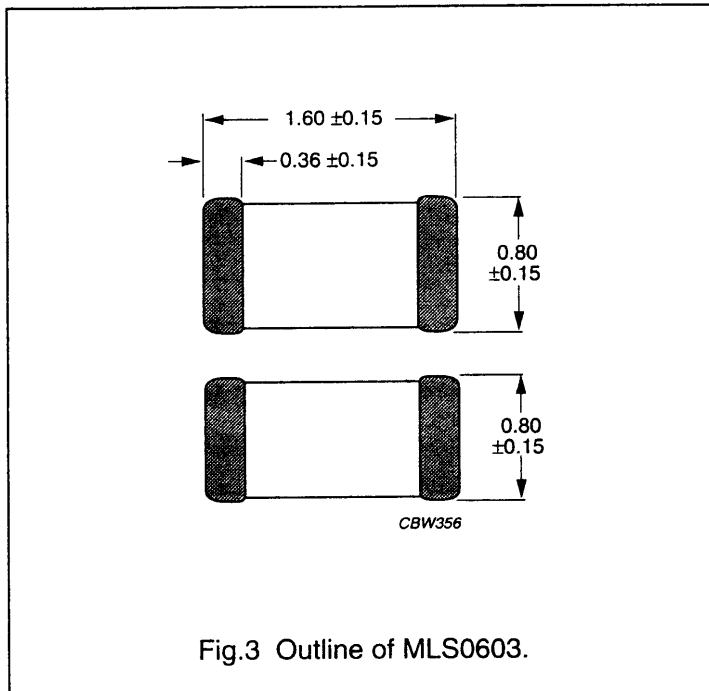
**Mass**

Approximately 5 mg.

Product specifications

GRADE	SIZE	Z at 100 MHz (Ω)	R _{DC} MAX. (Ω)	I MAX. (mA)	TYPE NUMBER	
4S7	0603	60	0.2	300	MLS0603-4S7-600	des
		100	0.3	250	MLS0603-4S7-101	des
		120	0.3	250	MLS0603-4S7-121	des
		150	0.3	250	MLS0603-4S7-151	des
		300	0.35	230	MLS0603-4S7-301	des
		600	0.45	210	MLS0603-4S7-601	des
		1000	0.6	190	MLS0603-4S7-102	des

Soft Ferrites

Multilayer suppressors

MOUNTING

Soldering profiles

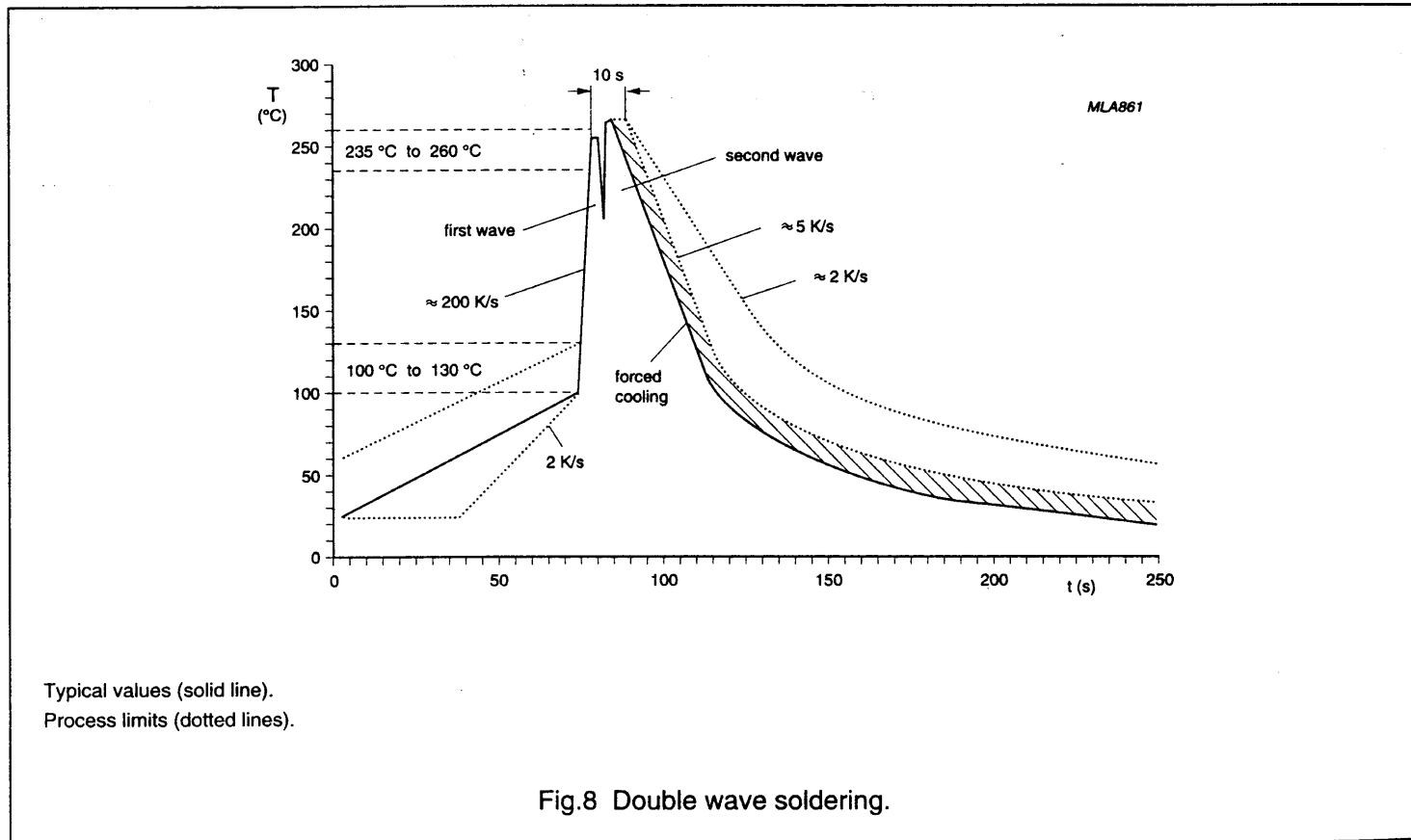
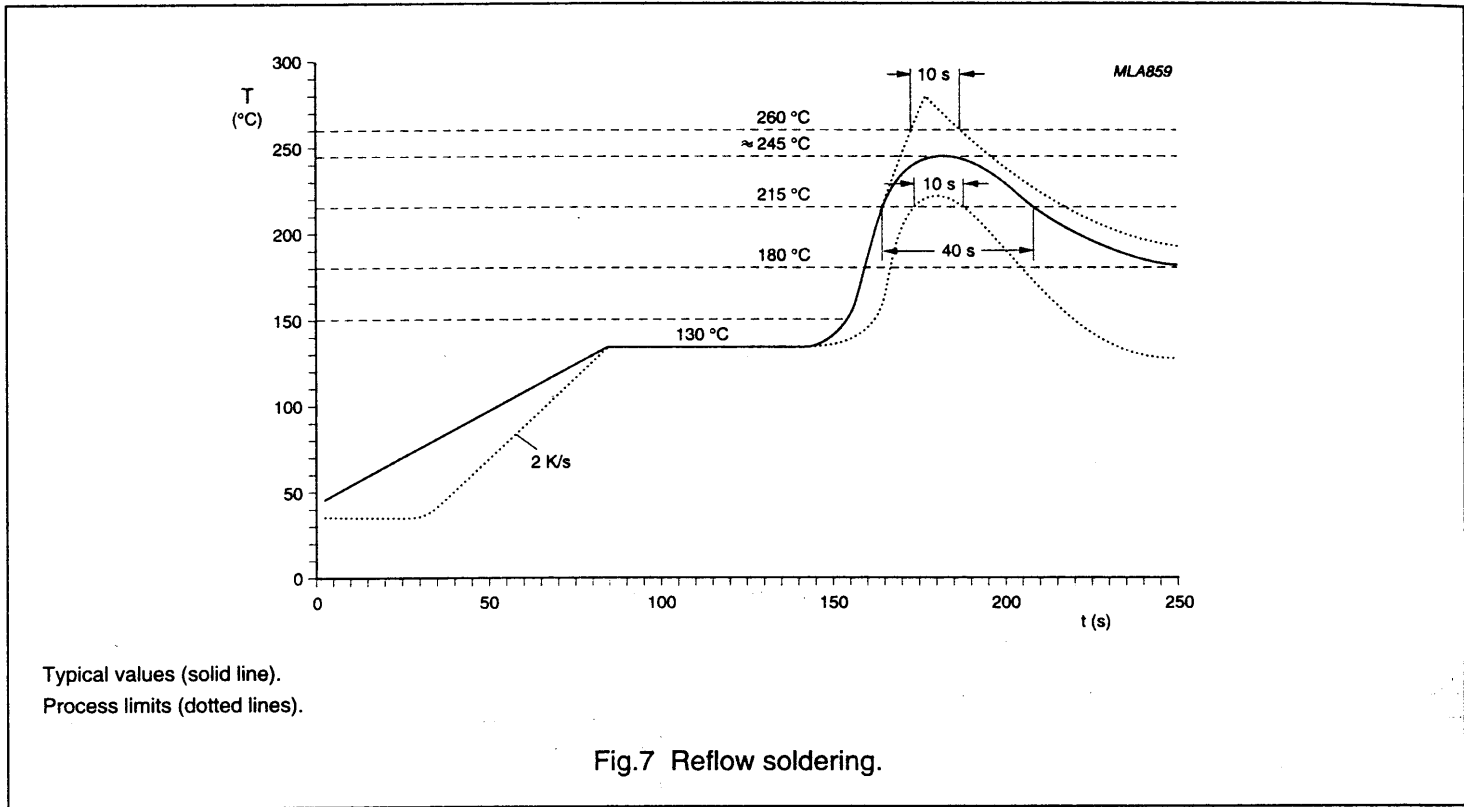

Soft Ferrites

Multilayer suppressors

Dimensions of solderlands

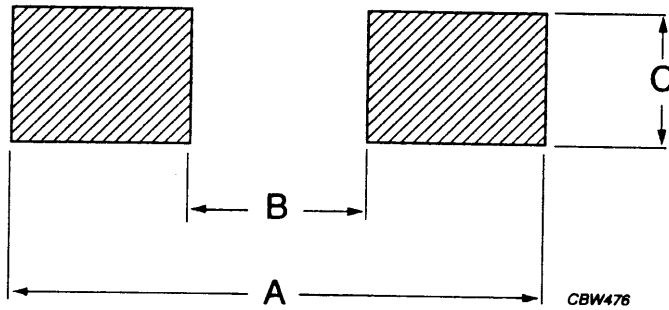

For dimensions see Table 1.

Fig.9 Recommended dimensions of solder lands.

Table 1 Solder land dimensions; see Fig.9

CASE SIZE	FOOTPRINT DIMENSIONS (mm)		
	A	B	C
0603	2.1	0.7	0.7
0805	2.6	1.0	1.0
1206	4.4	2.2	1.35
1806	6.0	3.0	1.35

Soft Ferrites

Multilayer suppressors

BLISTER TAPE AND REEL DIMENSIONS

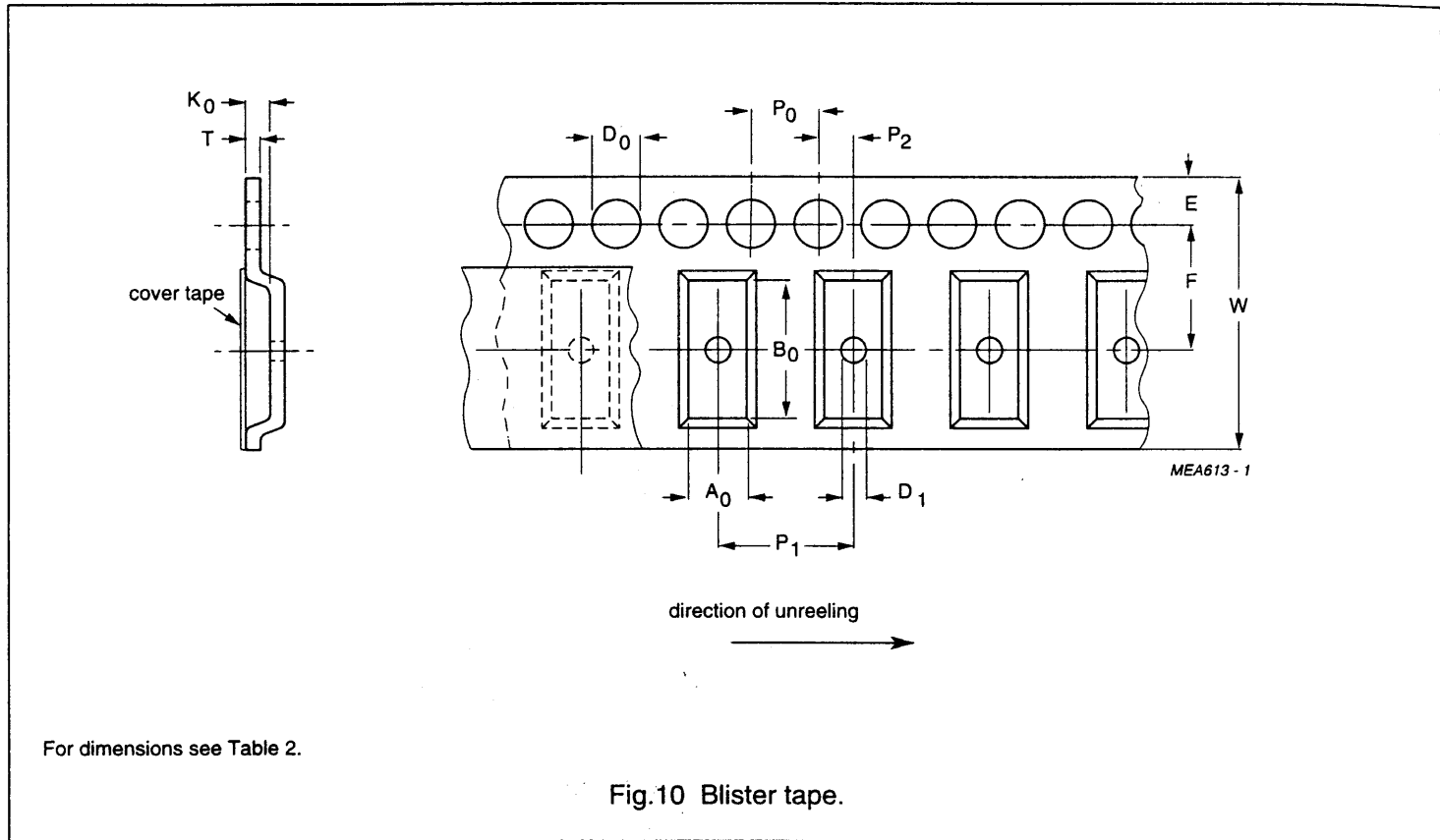

Table 2 Dimensions of blister tape for relevant product size code; see Fig.10

DIMENSION	PRODUCT SIZE CODE			
	0603	0805	1206	1806
A_0	1.1 ± 0.1	1.6 ± 0.1	2.0 ± 0.1	2.0 ± 0.1
B_0	1.9 ± 0.1	2.4 ± 0.1	3.6 ± 0.1	5.0 ± 0.2
K_0 minimum clearance; note 1	1.1	1.2	1.2	2.0
W	8.0 ± 0.2	8.0 ± 0.2	8.0 ± 0.2	12.0 ± 0.3
E	-	-	-	-
F	-	-	-	-
$D_{0 \text{ min}}$	0.5	0.5	0.5	0.5
$D_{1 \text{ min}}$	0.5	0.5	0.5	0.5
P_0	4.0	4.0	4.0	8.0
P_1	4.0 ± 0.1	4.0 ± 0.1	4.0 ± 0.1	4.0 ± 0.1
P_2	-	-	-	-
T_{max}	0.3	0.3	0.3	0.3

Note

1. Typical product displacement in pocket.

Soft Ferrites

Multilayer suppressors

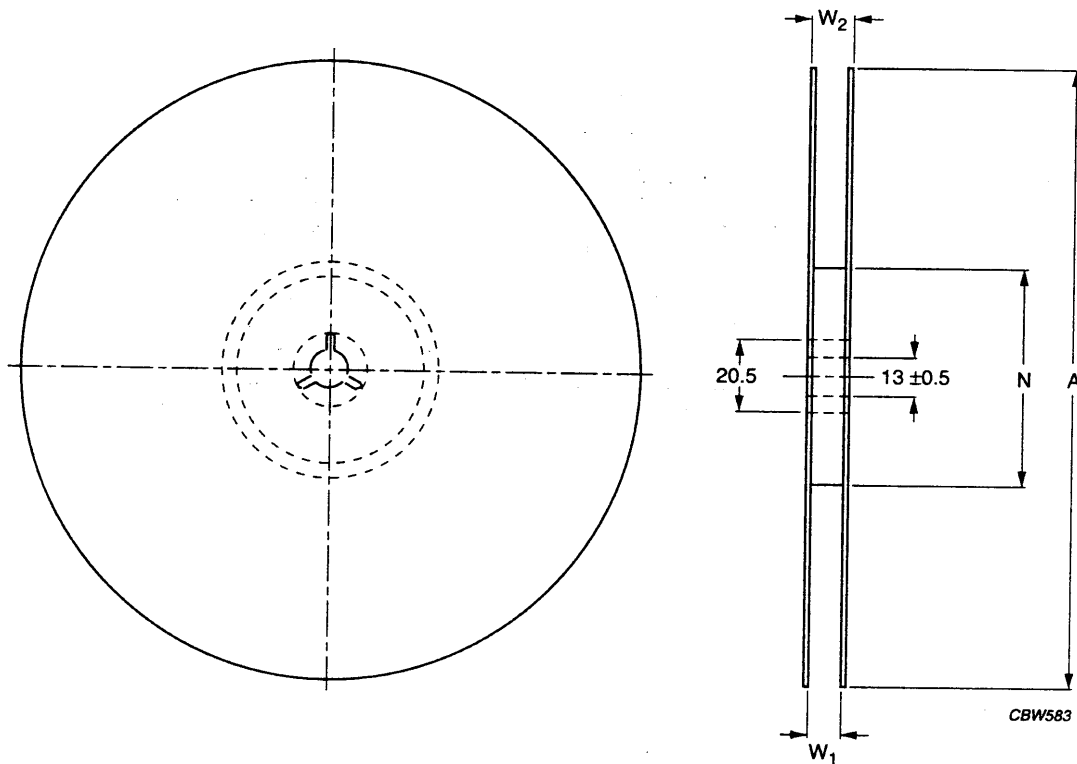

Dimensions in mm.
For dimensions see Table 3.

Fig.11 Reel.

Table 3 Reel dimensions; see Fig.11

TAPE WIDTH	DIMENSIONS (mm)			
	A	N MIN.	W ₁	W ₂
8	178 ±2	50	10 ±1.5	—
12			14 ±1.5	—