



### Description

The 1812L series device provides surface mount overcurrent protection for applications where resettable protection is desired.

### Features

- RoHS compliant and lead-free
- Fast response to fault currents
- Compact design saves board space
- Low resistance
- Low-profile
- Compatible with high temperature solders

### Agency Approvals

AGENCY	AGENCY FILE NUMBER
	E183209
	R50082521



### Applications

- Plug and play protection for motherboards and peripherals
- USB peripherals
- PCI cards
- Game console port protection

### Electrical Characteristics

Part Number	Marking	I <sub>hold</sub> (A)	I <sub>trip</sub> (A)	V <sub>max</sub> (Vdc)	I <sub>max</sub> (A)	P <sub>d</sub> max. (W)	Maximum Time To Trip		Resistance			Agency Approvals	
							Current (A)	Time (Sec.)	R <sub>min</sub> (Ω)	R <sub>typ</sub> (Ω)	R <sub>1max</sub> (Ω)		
1812L010	LF010	0.10	0.30	30	100	0.8	0.50	1.50	1.600	7.000	15.000	X	X
1812L014	LF014	0.14	0.34	60	10	0.8	1.50	0.15	1.500	4.000	6.000	X	X
1812L020	LF020	0.20	0.40	30	100	0.8	8.00	0.02	0.800	2.900	5.000	X	X
1812L050-C	LF050	0.50	1.00	15	100	0.8	8.00	0.15	0.150	0.600	1.000	X	X
1812L075-C	LF075	0.75	1.50	13.2	100	0.8	8.00	0.20	0.100	0.260	0.450	X	X
1812L075/24	LF075-24	0.75	1.50	24	100	0.8	8.00	0.20	0.110	0.200	0.290	X	X
1812L075/33	LF075-33	0.75	1.50	33	20	0.8	8.00	0.20	0.110	0.260	0.400	X	X
1812L110-C	LF110	1.10	2.20	6	100	0.8	8.00	0.30	0.040	0.120	0.210	X	X
1812L110/16	LF110-16	1.10	1.95	16	100	0.8	8.00	0.50	0.060	0.120	0.180	X	X
1812L110/33	LF110-33	1.10	1.95	33	20	0.8	8.00	0.50	0.060	0.120	0.200	X	X
1812L125-C	LF125	1.25	2.50	15	100	0.8	8.00	0.40	0.050	0.160	0.250	X	X
1812L125/6	LF125-6	1.25	2.50	6	100	0.8	8.00	0.40	0.050	0.090	0.140	X	X
1812L150-C	LF150	1.50	3.00	8	100	0.8	8.00	0.30	0.040	0.070	0.110	X	X
1812L150/12	LF150-12	1.50	3.00	12	100	0.8	8.00	0.50	0.040	0.070	0.110	X	X
1812L150/24	LF150-24	1.50	3.00	24	20	0.8	8.00	1.50	0.040	0.070	0.120	X	X
1812L160-C	LF160	1.60	2.80	8	100	0.8	8.00	1.00	0.030	0.066	0.100	X	X

**Electrical Characteristics (continued)**

Part Number	Marking	I <sub>hold</sub> (A)	I <sub>trip</sub> (A)	V <sub>max</sub> (Vdc)	I <sub>max</sub> (A)	P <sub>d</sub> max. (W)	Maximum Time To Trip		Resistance			Agency Approvals	
							Current (A)	Time (Sec.)	R <sub>min</sub> (Ω)	R <sub>typ</sub> (Ω)	R <sub>1max</sub> (Ω)		
1812L160/12	LF160-12	1.60	2.80	12	100	0.8	8.00	1.00	0.030	0.066	0.100	X	X
1812L200-C	LF200	2.00	3.50	8	100	0.8	8.00	2.00	0.020	0.040	0.060	X	X
1812L260-C	LF260	2.60	5.00	6	100	0.8	8.00	2.50	0.015	0.030	0.047	X	X

I<sub>hold</sub> = Hold current: maximum current device will pass without tripping in 20°C still air.

I<sub>trip</sub> = Trip current: minimum current at which the device will trip in 20°C still air.

V<sub>max</sub> = Maximum voltage device can withstand without damage at rated current (I<sub>max</sub>)

I<sub>max</sub> = Maximum fault current device can withstand without damage at rated voltage (V<sub>max</sub>)

P<sub>d</sub> = Power dissipated from device when in the tripped state at 20°C still air.

R<sub>min</sub> = Minimum resistance of device in initial (un-soldered) state.

R<sub>typ</sub> = Typical resistance of device in initial (un-soldered) state.

R<sub>1max</sub> = Maximum resistance of device at 20°C measured one hour after tripping or reflow soldering of 260°C for 20 sec.

**Caution:** Operation beyond the specified rating may result in damage and possible arcing and flame.

**Temperature Derating**

Part Number	Ambient Operation Temperature								
	-40°C	-20°C	0°C	23°C	40°C	50°C	60°C	70°C	85°C
	Hold Current (A)								
1812L010	0.16	0.14	0.12	0.10	0.08	0.07	0.06	0.05	0.03
1812L014	0.23	0.19	0.17	0.14	0.12	0.10	0.09	0.08	0.06
1812L020	0.29	0.26	0.23	0.20	0.17	0.15	0.14	0.12	0.10
1812L050-C	0.77	0.68	0.59	0.50	0.44	0.40	0.37	0.33	0.29
1812L075-C	1.15	1.01	0.88	0.75	0.65	0.60	0.55	0.49	0.43
1812L075/24	1.06	0.95	0.84	0.75	0.60	0.55	0.50	0.45	0.37
1812L075/33	1.10	1.00	0.88	0.75	0.66	0.60	0.56	0.47	0.36
1812L110-C	1.59	1.43	1.26	1.10	0.95	0.87	0.80	0.71	0.60
1812L110/16	1.58	1.43	1.27	1.10	0.95	0.85	0.77	0.71	0.58
1812L110/33	1.55	1.40	1.25	1.10	0.93	0.83	0.73	0.63	0.50
1812L125-C	2.00	1.75	1.52	1.25	1.00	0.95	0.90	0.75	0.53
1812L125/6	2.00	1.75	1.52	1.25	1.00	0.95	0.90	0.75	0.53
1812L150-C	2.06	1.93	1.79	1.50	1.28	1.10	1.02	0.80	0.68
1812L150/12	2.04	1.88	1.68	1.50	1.25	1.10	1.00	0.80	0.60
1812L150/24	2.05	1.87	1.67	1.50	1.25	1.08	0.95	0.77	0.60
1812L160-C	2.20	2.06	1.91	1.60	1.36	1.17	1.09	0.85	0.72
1812L160/12	2.18	2.01	1.79	1.60	1.34	1.16	1.07	0.83	0.60
1812L200-C	3.08	2.71	2.35	2.00	1.80	1.60	1.50	1.07	0.80
1812L260-C	4.00	3.52	3.06	2.60	2.34	2.08	1.95	1.39	1.04

**Average Time Current Curves**

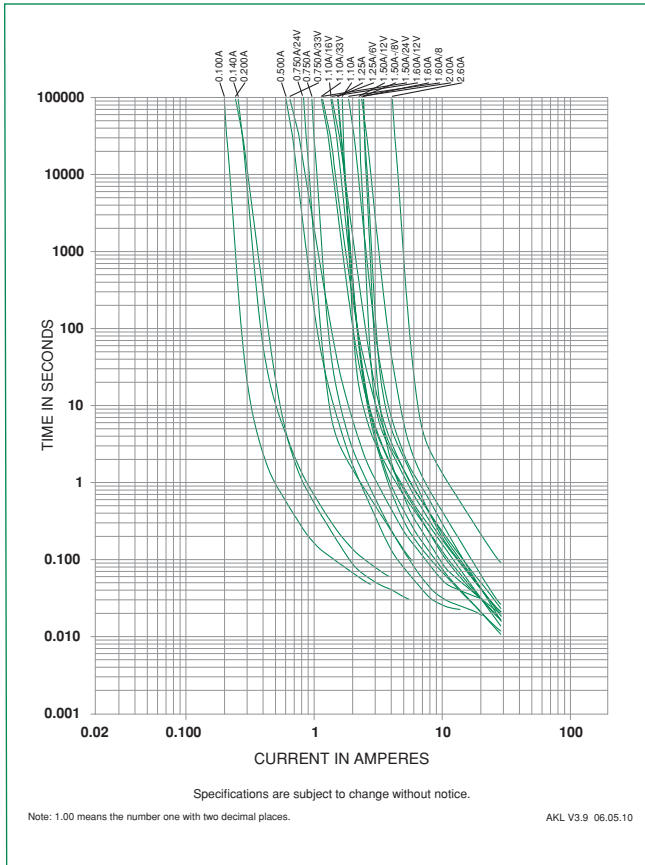

The average time current curves and temperature derating curve performance is affected by a number of variables, and these curves provided as guidance only. Customer must verify the performance in their application.

**Temperature Derating Curve**

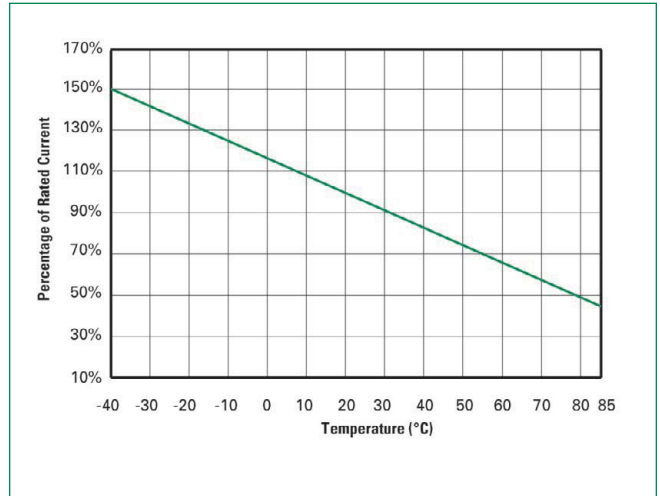

**1812L Series**

**Soldering Parameters**

Condition	Reflow
Peak Temp/ DurationTime	260°C / 10 Sec
Time above liquids (TAL) 220°C	60 Sec ~ 100 Sec
Preheat 120°C~ 180°C	50 Sec ~ 150 Sec
Storage Condition	0°C~35°C, ≤70%RH

- Recommended reflow methods: IR, vapor phase oven, hot air oven, N<sub>2</sub> environment for lead-free
- Recommended maximum paste thickness is 0.25mm (0.010 inch)
- Devices can be cleaned using standard industry methods and solvents.

**Note:** If reflow temperatures exceed the recommended profile, devices may not meet the performance requirements.

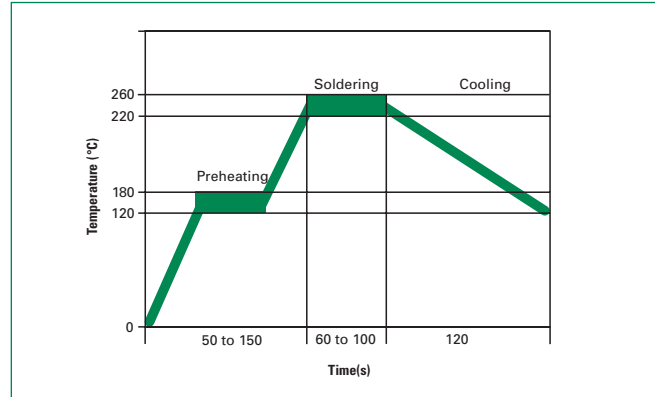

**Physical Specifications**

<b>Terminal Material</b>	Solder-Plated Copper (Solder Material: Matte Tin (Sn))
<b>Lead Solderability</b>	Meets EIA Specification RS186-9E, ANSI/J-STD-002 Category 3.

**Environmental Specifications**

<b>Operating/Storage Temperature</b>	-40°C to +85°C
<b>Maximum Device Surface Temperature in Tripped State</b>	125°C
<b>Passive Aging</b>	+85°C, 1000 hours ±5% typical resistance change
<b>Humidity Aging</b>	+85°C, 85%R.H. 1000 hours ±5% typical resistance change
<b>Thermal Shock</b>	MIL-STD-202 Method 107G +85°C/-40°C 20 times -30% typical resistance change
<b>Solvent Resistance</b>	MIL-STD-202, Method 215 No change
<b>Vibration</b>	MIL-STD-883C, Method 2007.1, Condition A No change

**Dimensions**

MARKING CODE VARIES  
WITH AMPERAGE AND VOLTAGE RATING  
(SEE CHART)  
SHOWN ARE:  
- 1.1A/6V RATING (LEFT)  
- 1.1A/33V RATING (RIGHT)

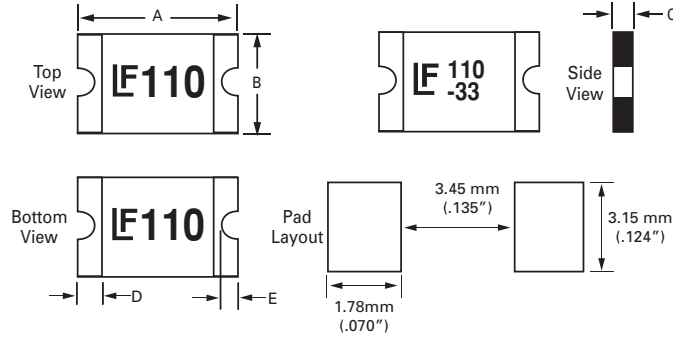

Part Number	A				B				C				D		E			
	Inches		mm		Inches		mm		Inches		mm		Inches	mm	Inches		mm	
	Min.	Max.	Min.	Max.	Min.	Max.	Min.	Max.	Min.	Max.	Min.	Max.	Min.	Min.	Min.	Max.	Min.	Max.
1812L010	0.17	0.19	4.37	4.73	0.12	0.13	3.07	3.41	0.03	0.05	0.75	1.25	0.01	0.30	0.01	0.03	0.25	0.65
1812L014	0.17	0.19	4.37	4.73	0.12	0.13	3.07	3.41	0.03	0.08	0.75	1.95	0.01	0.30	0.01	0.03	0.25	0.65
1812L020	0.17	0.19	4.37	4.73	0.12	0.13	3.07	3.41	0.02	0.04	0.55	1	0.01	0.30	0.01	0.03	0.25	0.65
1812L050-C	0.17	0.19	4.37	4.73	0.12	0.13	3.07	3.41	0.02	0.03	0.5	0.75	0.01	0.30	0.01	0.02	0.25	0.5
1812L075-C	0.17	0.19	4.37	4.73	0.12	0.13	3.07	3.41	0.02	0.03	0.5	0.75	0.01	0.30	0.01	0.02	0.25	0.5
1812L075/24	0.17	0.19	4.37	4.73	0.12	0.13	3.07	3.41	0.03	0.06	0.75	1.55	0.01	0.30	0.01	0.03	0.25	0.65
1812L075/33	0.17	0.19	4.37	4.73	0.12	0.13	3.07	3.41	0.03	0.06	0.75	1.55	0.01	0.30	0.01	0.03	0.25	0.65
1812L110-C	0.17	0.19	4.37	4.73	0.12	0.13	3.07	3.41	0.02	0.03	0.5	0.71	0.01	0.30	0.01	0.02	0.25	0.5
1812L110/16	0.17	0.19	4.37	4.73	0.12	0.13	3.07	3.41	0.03	0.05	0.75	1.25	0.01	0.30	0.01	0.03	0.25	0.65
1812L110/33	0.17	0.19	4.37	4.73	0.12	0.13	3.07	3.41	0.05	0.08	1.2	2	0.01	0.30	0.01	0.03	0.25	0.65
1812L125-C	0.17	0.19	4.37	4.73	0.12	0.13	3.07	3.41	0.03	0.05	0.75	1.25	0.01	0.30	0.01	0.02	0.25	0.5
1812L125/6	0.17	0.19	4.37	4.73	0.12	0.13	3.07	3.41	0.02	0.03	0.45	0.75	0.01	0.30	0.01	0.03	0.25	0.65
1812L150-C	0.17	0.19	4.37	4.73	0.12	0.13	3.07	3.41	0.02	0.03	0.4	0.71	0.01	0.30	0.01	0.03	0.25	0.65
1812L150/12	0.17	0.19	4.37	4.73	0.12	0.13	3.07	3.41	0.03	0.05	0.75	1.25	0.01	0.30	0.01	0.03	0.25	0.65
1812L150/24	0.17	0.19	4.37	4.73	0.12	0.13	3.07	3.41	0.03	0.07	0.8	1.8	0.01	0.30	0.01	0.03	0.25	0.65
1812L160-C	0.17	0.19	4.37	4.73	0.12	0.13	3.07	3.41	0.02	0.03	0.4	0.75	0.01	0.30	0.01	0.03	0.25	0.65
1812L160/12	0.17	0.19	4.37	4.73	0.12	0.13	3.07	3.41	0.03	0.05	0.75	1.25	0.01	0.30	0.01	0.03	0.25	0.65
1812L200-C	0.17	0.19	4.37	4.73	0.12	0.13	3.07	3.41	0.03	0.05	0.81	1.2	0.01	0.30	0.01	0.02	0.25	0.5
1812L260-C	0.17	0.19	4.37	4.73	0.12	0.13	3.07	3.41	0.03	0.05	0.8	1.34	0.01	0.30	0.01	0.02	0.25	0.5

1812L Series

**Part Numbering System**

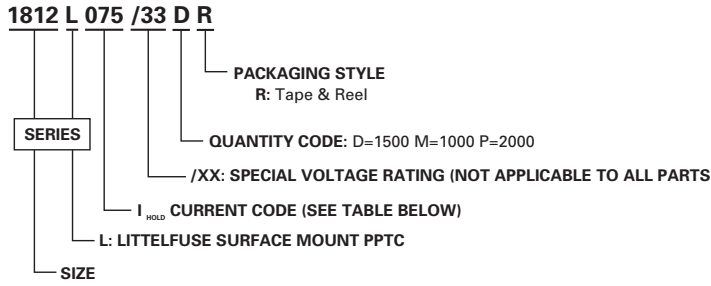

**Packaging**

I <sub>hold</sub> (A)	I <sub>hold</sub> Code	Voltage Option	Packaging Option	Quantity	Quantity & Packaging Codes
0.10	010		Tape and Reel	1500	DR
0.14	014		Tape and Reel	1500	DR
0.20	020		Tape and Reel	2000	PR
0.50	050		Tape and Reel	2000	PR
0.75	075		Tape and Reel	2000	PR
		/24	Tape and Reel	1500	DR
		/33	Tape and Reel	1500	DR
1.10	110		Tape and Reel	2000	PR
		/16	Tape and Reel	1500	DR
		/33	Tape and Reel	1000	MR
1.25	125		Tape and Reel	1500	DR
		/6	Tape and Reel	2000	PR
1.50	150		Tape and Reel	2000	ZR
		/12	Tape and Reel	1500	DR
		/24	Tape and Reel	1000	MR
1.60	160		Tape and Reel	2000	PR
		/12	Tape and Reel	1500	DR
2.00	200		Tape and Reel	1500	DR
2.60	260		Tape and Reel	1000	ZR