

40A, 100V, 0.040 Ohm, N-Channel Power MOSFETs

These are N-Channel power MOSFETs manufactured using the MegaFET process. This process, which uses feature sizes approaching those of LSI integrated circuits gives optimum utilization of silicon, resulting in outstanding performance. They were designed for use in applications such as switching regulators, switching converters, motor drivers, relay drivers and emitter switches for bipolar transistors. These transistors can be operated directly from integrated circuits.

Formerly developmental type TA9846

Ordering Information

PART NUMBER	PACKAGE	BRAND
RFG40N10	TO-247	RFG40N10
RFP40N10	TO-220AB	RFP40N10
RF1S40N10	TO-262AA	F1S40N10
RF1S40N10SM	TO-263AB	F1S40N10

NOTE: When ordering, use the entire part number. Add the suffix, 9A, to obtain the TO-263AB variant in tape and reel, i.e. RF1S40N10SM9A.

Features

- 40A, 100V
- $r_{DS(ON)} = 0.040\Omega$
- UIS Rating Curve
- SOA is Power Dissipation Limited
- 175°C Operating Temperature
- Related Literature
 - TB334 "Guidelines for Soldering Surface Mount Components to PC Boards"

Symbol

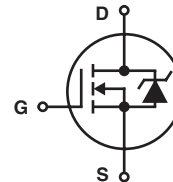

Packaging

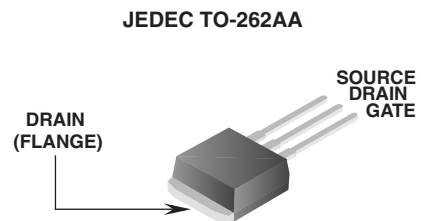
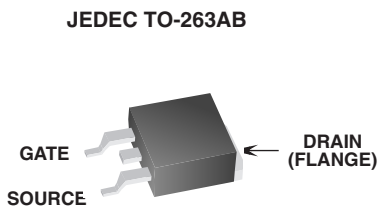
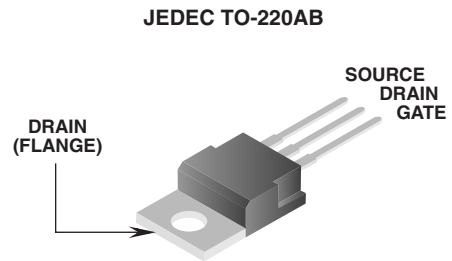
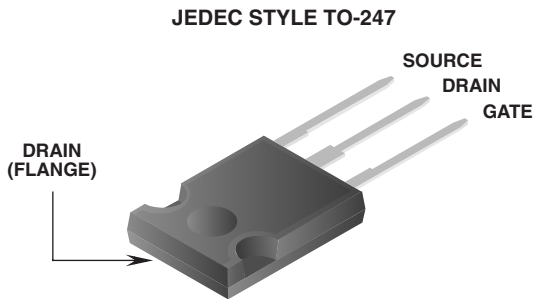

RFG40N10, RFP40N10, RF1S40N10, RF1S40N10SM

Absolute Maximum Ratings $T_C = 25^\circ\text{C}$, Unless Otherwise Specified

	RFG40N10, RFP40N10, RF1S40N10, RF1S40N10SM	UNITS
Drain to Source Breakdown Voltage (Note 1)	V_{DSS} 100	V
Drain to Gate Voltage ($R_{GS} = 1\text{M}\Omega$) (Note 1)	V_{DGR} 100	V
Gate to Source Voltage	V_{GS} ± 20	V
Drain Current		
Continuous (Figure 2).	I_D 40	A
Pulsed Drain Current (Note 2)	I_{DM} 100	A
Pulsed Avalanche Rating	E_{AS} Figures 4, 12, 13	
Power Dissipation	P_D 160	W
Derate Above 25°C	1.07	W/ $^\circ\text{C}$
Operating and Storage Temperature	T_J, T_{STG} -55 to 175	$^\circ\text{C}$
Maximum Temperature for Soldering		
Leads at 0.063in (1.6mm) from case for 10s	T_L 300	$^\circ\text{C}$
Package Body for 10s, see Techbrief 334	T_{pkg} 260	$^\circ\text{C}$

CAUTION: Stresses above those listed in "Absolute Maximum Ratings" may cause permanent damage to the device. This is a stress only rating and operation of the device at these or any other conditions above those indicated in the operational sections of this specification is not implied.

NOTES:

1. $T_J = 25^\circ\text{C}$ to 150°C .
2. Repetitive Rating: pulse width limited by maximum junction temperature.

Electrical Specifications $T_C = 25^\circ\text{C}$, Unless Otherwise Specified

PARAMETER	SYMBOL	TEST CONDITIONS	MIN	TYP	MAX	UNITS	
Drain to Source Breakdown Voltage	BV_{DSS}	$I_D = 250\mu\text{A}, V_{GS} = 0\text{V}$ (Figure 9)	100	-	-	V	
Gate Threshold Voltage	$V_{GS(TH)}$	$V_{GS} = V_{DS}, I_D = 250\mu\text{A}$ (Figure 8)	2	-	4	V	
Zero Gate Voltage Drain Current	I_{DSS}	$V_{DS} = 80\text{V}, V_{GS} = 0\text{V}$	$T_C = 25^\circ\text{C}$	-	-	1	μA
			$T_C = 150^\circ\text{C}$	-	-	50	μA
Gate to Source Leakage Current	I_{GSS}	$V_{GS} = \pm 20\text{V}$	-	-	± 100	nA	
Drain to Source On Resistance	$r_{DS(ON)}$	$I_D = 40\text{A}, V_{GS} = 10\text{V}$ (Figure 7)	-	-	0.040	Ω	
Turn-On Time	t_{ON}	$V_{DD} = 50\text{V}, I_D = 20\text{A}, R_L = 2.5\Omega, V_{GS} = 10\text{V}, R_{GS} = 4.2\Omega$ (Figure 11)	-	-	80	ns	
Turn-On Delay Time	$t_{d(ON)}$		-	17	-	ns	
Rise Time	t_r		-	30	-	ns	
Turn-Off Delay Time	$t_{d(OFF)}$		-	42	-	ns	
Fall Time	t_f		-	20	-	ns	
Turn-Off Time	t_{OFF}		-	-	100	ns	
Total Gate Charge	$Q_{g(TOT)}$	$V_{GS} = 0\text{V to } 20\text{V}$	-	-	300	nC	
Gate Charge at 10V	$Q_{g(10)}$	$V_{GS} = 0\text{V to } 10\text{V}$					
Threshold Gate Charge	$Q_{g(TH)}$	$V_{GS} = 0\text{V to } 2\text{V}$					
Thermal Resistance Junction to Case	$R_{\theta JC}$		-	-	0.94	$^\circ\text{C/W}$	
Thermal Resistance Junction to Ambient	$R_{\theta JA}$	TO-247	-	-	30	$^\circ\text{C/W}$	
		TO-220AB and TO-263AB	-	-	62	$^\circ\text{C/W}$	

Source to Drain Diode Specifications

PARAMETER	SYMBOL	TEST CONDITIONS	MIN	TYP	MAX	UNITS
Source to Drain Diode Voltage	V_{SD}	$I_{SD} = 40\text{A}$	-	-	1.5	V
Reverse Recovery Time	t_{rr}	$I_{SD} = 40\text{A}, dI_{SD}/dt = 100\text{A}/\mu\text{s}$	-	-	200	ns

Typical Performance Curves Unless Otherwise Specified

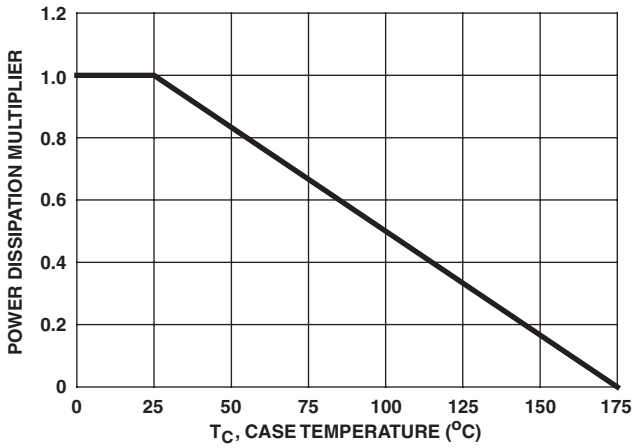

FIGURE 1. NORMALIZED POWER DISSIPATION vs CASE TEMPERATURE

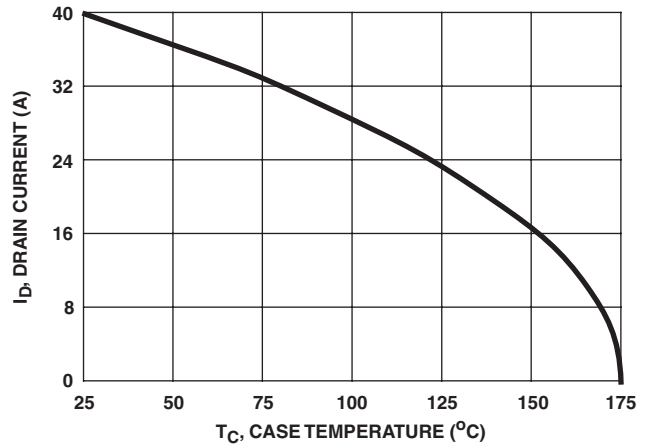

FIGURE 2. MAXIMUM CONTINUOUS DRAIN CURRENT vs CASE TEMPERATURE

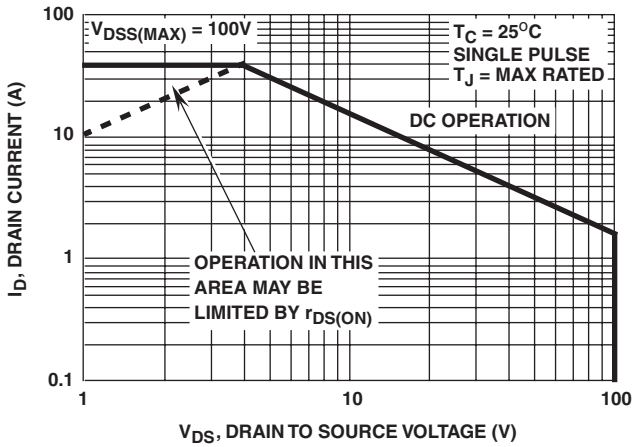
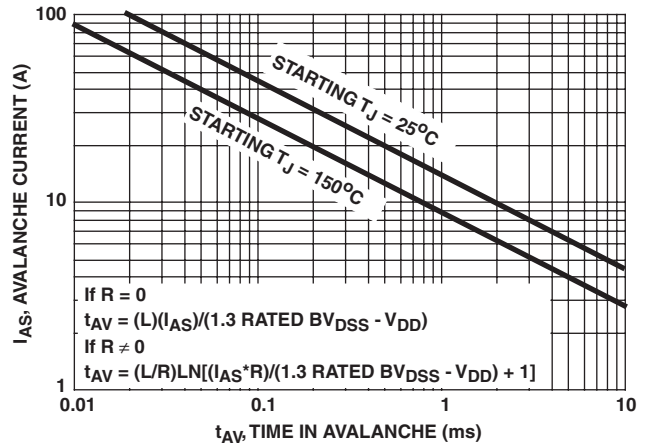

FIGURE 3. FORWARD BIAS SAFE OPERATING AREA



NOTE: Refer to application notes AN9321 and AN9322.

FIGURE 4. UNCLAMPED INDUCTIVE SWITCHING CAPABILITY

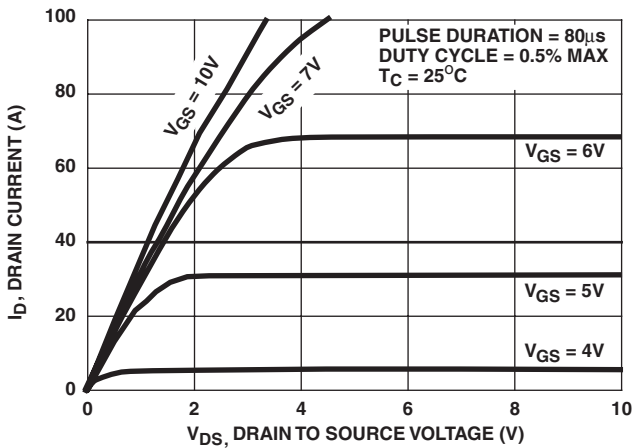

FIGURE 5. SATURATION CHARACTERISTICS

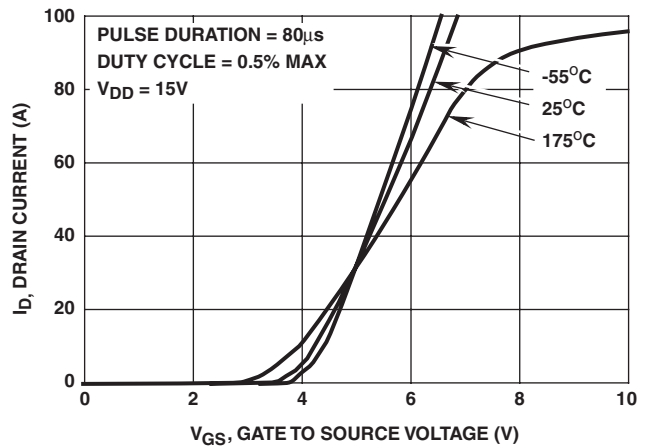

FIGURE 6. TRANSFER CHARACTERISTICS

Typical Performance Curves Unless Otherwise Specified (Continued)

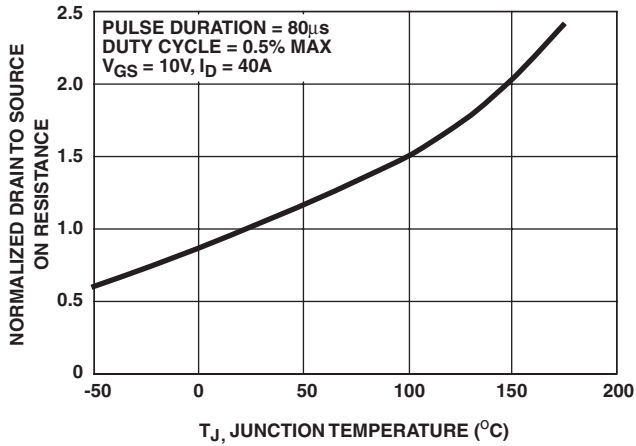

FIGURE 7. NORMALIZED DRAIN TO SOURCE ON RESISTANCE vs JUNCTION TEMPERATURE

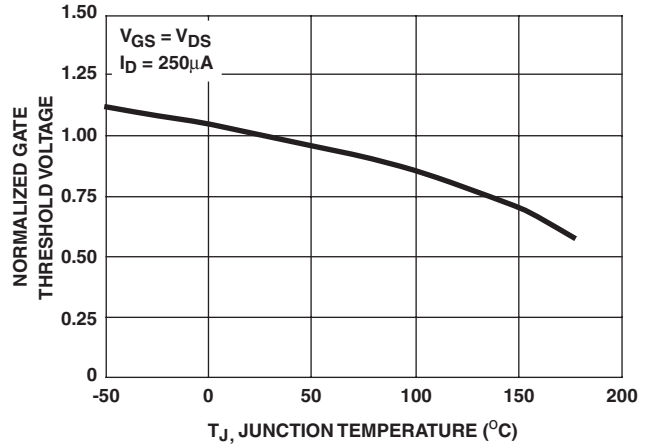

FIGURE 8. NORMALIZED GATE THRESHOLD VOLTAGE vs JUNCTION TEMPERATURE

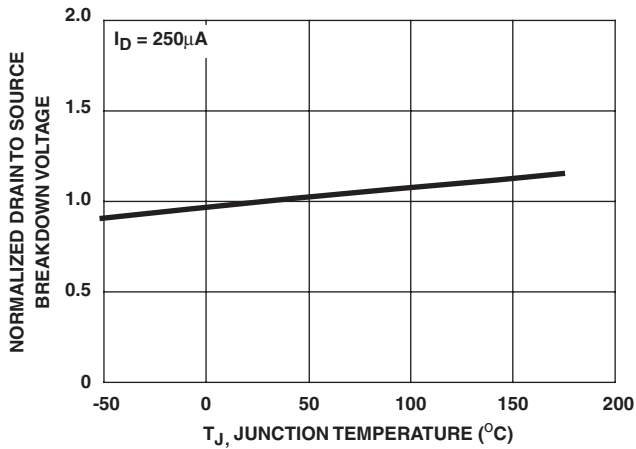

FIGURE 9. NORMALIZED DRAIN TO SOURCE BREAKDOWN VOLTAGE vs JUNCTION TEMPERATURE

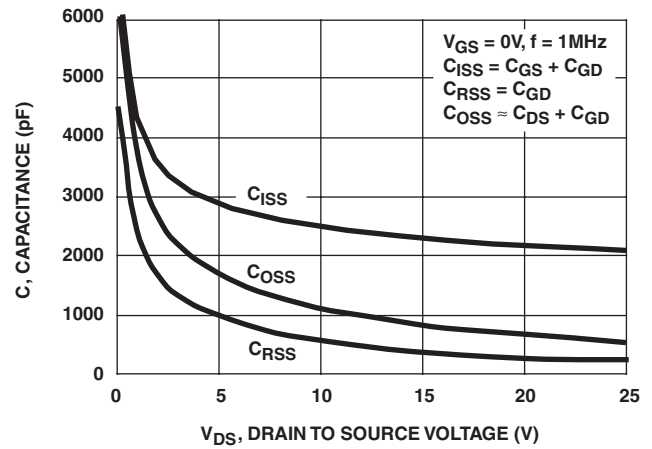
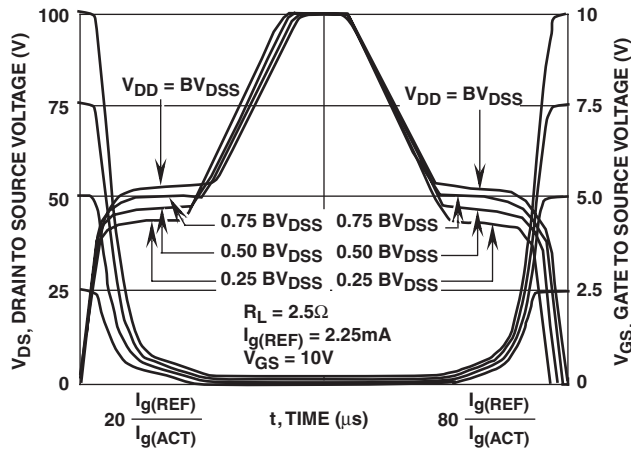

FIGURE 10. CAPACITANCE vs DRAIN TO SOURCE VOLTAGE



NOTE: Refer to Application Notes AN7254 and AN7260.

FIGURE 11. NORMALIZED SWITCHING WAVEFORMS FOR CONSTANT GATE CURRENT

Test Circuits and Waveforms

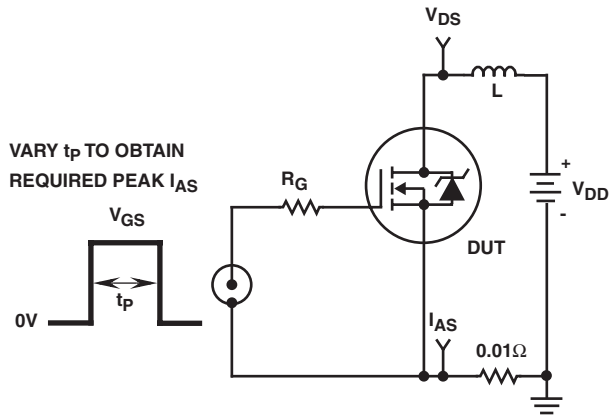

FIGURE 12. UNCLAMPED ENERGY TEST CIRCUIT

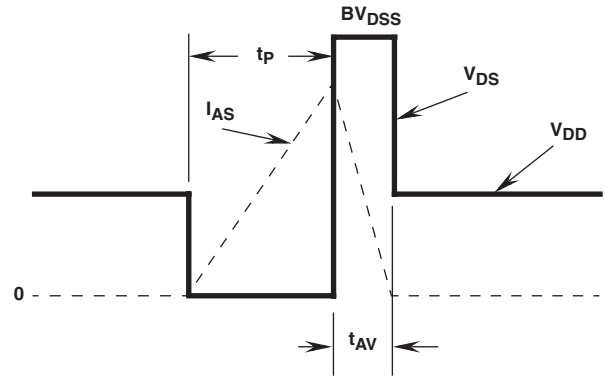

FIGURE 13. UNCLAMPED ENERGY WAVEFORMS

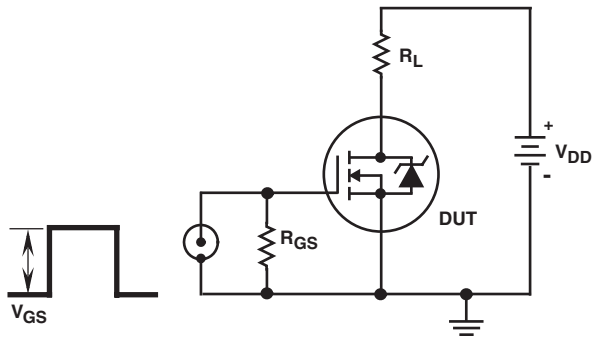

FIGURE 14. SWITCHING TIME TEST CIRCUIT

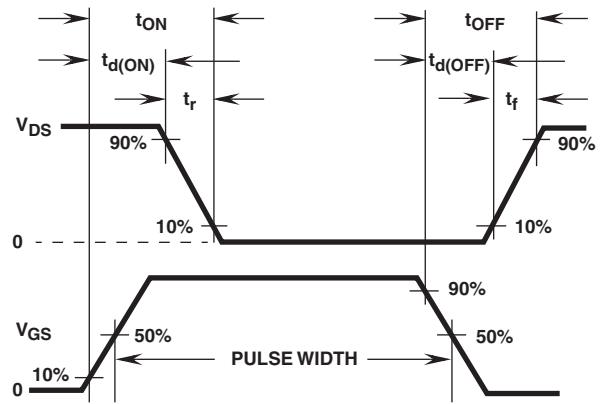

FIGURE 15. RESISTIVE SWITCHING WAVEFORMS

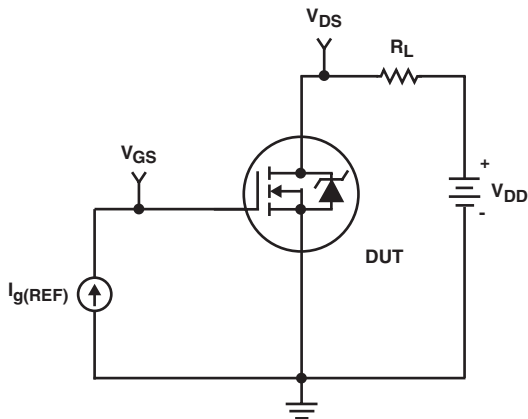

FIGURE 16. GATE CHARGE TEST CIRCUIT

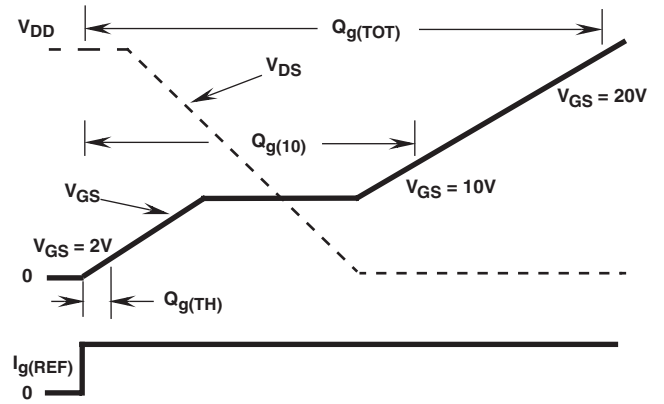

FIGURE 17. GATE CHARGE WAVEFORMS

TRADEMARKS

The following are registered and unregistered trademarks Fairchild Semiconductor owns or is authorized to use and is not intended to be an exhaustive list of all such trademarks.

ACE _x TM	FAST [®]	OPTOLOGIC TM	SMART START TM	VCX TM
Bottomless TM	FAST _r TM	OPTOPLANAR TM	STAR*POWER TM	
CoolFET TM	FRFET TM	PACMAN TM	Stealth TM	
CROSSVOLT TM	GlobalOptoisolator TM	POPT TM	SuperSOT TM -3	
DenseTrench TM	GTO TM	Power247 TM	SuperSOT TM -6	
DOME TM	HiSeC TM	PowerTrench [®]	SuperSOT TM -8	
EcoSPARK TM	ISOPLANAR TM	QFET TM	SyncFET TM	
E ² CMOS TM	LittleFET TM	QST TM	TinyLogic TM	
EnSigna TM	MicroFET TM	QT Optoelectronics TM	TruTranslation TM	
FACT TM	MicroPak TM	Quiet Series TM	UHC TM	
FACT Quiet Series TM	MICROWIRE TM	SILENT SWITCHER [®]	UltraFET [®]	

STAR*POWER is used under license

DISCLAIMER

FAIRCHILD SEMICONDUCTOR RESERVES THE RIGHT TO MAKE CHANGES WITHOUT FURTHER NOTICE TO ANY PRODUCTS HEREIN TO IMPROVE RELIABILITY, FUNCTION OR DESIGN. FAIRCHILD DOES NOT ASSUME ANY LIABILITY ARISING OUT OF THE APPLICATION OR USE OF ANY PRODUCT OR CIRCUIT DESCRIBED HEREIN; NEITHER DOES IT CONVEY ANY LICENSE UNDER ITS PATENT RIGHTS, NOR THE RIGHTS OF OTHERS.

LIFE SUPPORT POLICY

FAIRCHILD'S PRODUCTS ARE NOT AUTHORIZED FOR USE AS CRITICAL COMPONENTS IN LIFE SUPPORT DEVICES OR SYSTEMS WITHOUT THE EXPRESS WRITTEN APPROVAL OF FAIRCHILD SEMICONDUCTOR CORPORATION.

As used herein:

1. Life support devices or systems are devices or systems which, (a) are intended for surgical implant into the body, or (b) support or sustain life, or (c) whose failure to perform when properly used in accordance with instructions for use provided in the labeling, can be reasonably expected to result in significant injury to the user.
2. A critical component is any component of a life support device or system whose failure to perform can be reasonably expected to cause the failure of the life support device or system, or to affect its safety or effectiveness.

PRODUCT STATUS DEFINITIONS

Definition of Terms

Datasheet Identification	Product Status	Definition
Advance Information	Formative or In Design	This datasheet contains the design specifications for product development. Specifications may change in any manner without notice.
Preliminary	First Production	This datasheet contains preliminary data, and supplementary data will be published at a later date. Fairchild Semiconductor reserves the right to make changes at any time without notice in order to improve design.
No Identification Needed	Full Production	This datasheet contains final specifications. Fairchild Semiconductor reserves the right to make changes at any time without notice in order to improve design.
Obsolete	Not In Production	This datasheet contains specifications on a product that has been discontinued by Fairchild semiconductor. The datasheet is printed for reference information only.

This datasheet has been download from:

www.datasheetcatalog.com

Datasheets for electronics components.