

Magnetic Level Sensor

Vertical Float

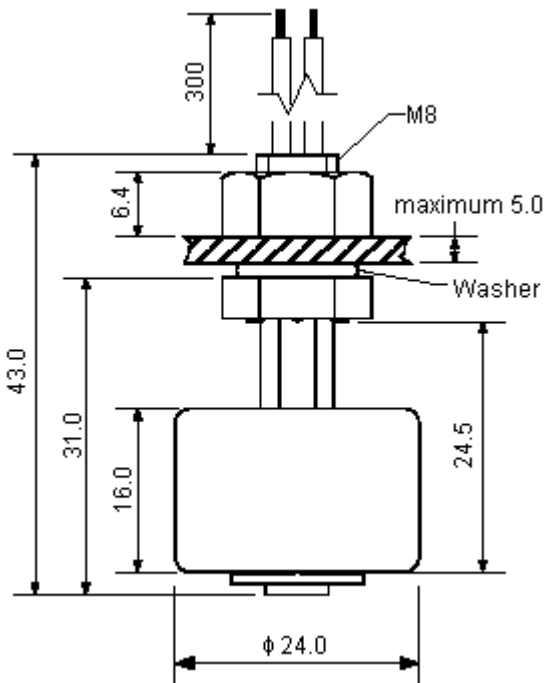

Operating Diagram

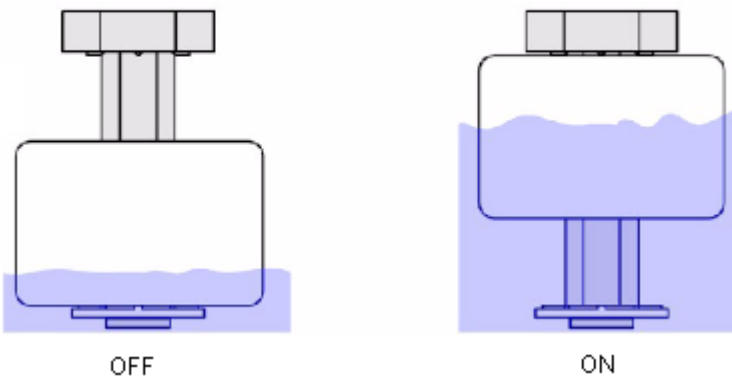

Magnetic Level Sensor

Vertical Float



Specifications:

Electrical Characteristics

Contact form (ASA) : A.
Contact material : Ru.
Maximum contact rating : 10W/VA.
Maximum switching current : 1.0A.
Maximum carry current : 1.2A.
Maximum switching voltage : 200V DC.
: 140V AC.
Minimum breakdown voltage : 240V DC.

Temperature Range

Operating temperature : -20 to +80°C.
Storage temperature : -30 to +80°C.

Material

Case/Nut : PP.
Float : PP.
Washer : TEP.
Potting compound : Epoxy.
Cable : UL 1007, AWG 24.

Testing

Sensors tested 100% for electrical function and operating distance.

Remarks

When mounted near ferromagnetic parts switching points may vary.

Part Number Table

Description	Part Number
Float Switch, NO, 140V	MCPLS-031-A-3

Disclaimer This data sheet and its contents (the "Information") belong to the Premier Farnell Group (the "Group") or are licensed to it. No licence is granted for the use of it other than for information purposes in connection with the products to which it relates. No licence of any intellectual property rights is granted. The Information is subject to change without notice and replaces all data sheets previously supplied. The Information supplied is believed to be accurate but the Group assumes no responsibility for its accuracy or completeness, any error in or omission from it or for any use made of it. Users of this data sheet should check for themselves the Information and the suitability of the products for their purpose and not make any assumptions based on information included or omitted. Liability for loss or damage resulting from any reliance on the Information or use of it (including liability resulting from negligence or where the Group was aware of the possibility of such loss or damage arising) is excluded. This will not operate to limit or restrict the Group's liability for death or personal injury resulting from its negligence. SPC Multicomp is the registered trademark of the Group. © Premier Farnell plc 2009.

<http://www.farnell.com>
<http://www.newark.com>
<http://www.cpc.co.uk>

