

6 Amp Bi-polar drive module

PM 546

Built on the 3U high International standard extended Eurocard format, the PM546 utilises surface mount technology for optimum space utilisation and reliability. With a width of only 34 mm (7E) up to 12 units can be fitted in single 19 in. standard Euro-rack.

Ideal choice for size 34 hybrid motors

With adjustable current from 2.5 to 6 amps / phase, combined with chopped constant current drive technology which enables current forcing from supply voltages up to 85 Vdc, the unit provides high efficiency and optimum performance characteristics when using size 23 & 34 hybrid stepper motors.



Advanced control features

The PM 546 design is based on many years experience in stepper motor drive technology and incorporates the following features to provide flexible control:

- High efficiency chopped constant current power stage provides increased performance and reduced current consumption
- Single supply rail simplifies power supply requirements
- Short circuit and open circuit protected power stage for increased reliability.
- Selectable full or half step phase logic control
- Adjustable current settings from 2.5A to 6 Amps per phase
- Choice of automatic or externally selectable reduced current for stationary motor conditions to reduce power consumption and motor heating.
- Over-temperature monitor with selectable automatic drive shutdown.
- Opto-isolated 'drive healthy' status output
- Opto-isolated control inputs.
- Control from external clock and direction signals
- Alternative control using on-board voltage controlled oscillator featuring:
externally gated adjustable base and high speed settings
adjustable acceleration/deceleration ramping.
choice of oscillator gating procedures to suit alternative control philosophies.
automatic ramping and controlled motor reversal eliminates motor stalling when high speed direction changes are required.

Simplified system integration

PM546 is designed for incorporation in standard 19 in Euro-rack units such as the PM175 racked power supply. A matched motherboard, MSB543 is recommended which enables all connections to be made via solder-free terminals. The PM546 will have particular appeal to systems engineers who wish to utilise the unit in modular form since it incorporates a filtered output stage to minimise electrical emissions and significantly reduces the need for additional suppression components.

The slim profile of the PM546 (only 7E wide) enables up to 6 units to be fitted in a single 3U high PM175 racked power supply.

Alternatively 3 units together with matched controllers to provide a complete self contained motion system can be integrated in a PM175 based package.

The drive is configured in the same way as the 2 Amp MSE542 unit. A single 8 way DIP switch is used to set the following functions, additional trimmers being provided at the front of the unit for adjustment of the internal oscillator when this is used.

Control settings

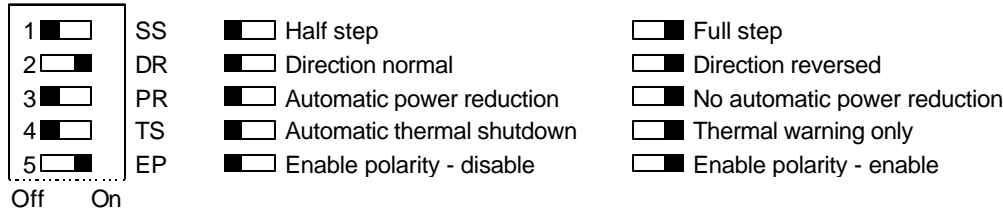

The above example shown the drive set for half step, with the direction reversed, automatic power reduction and automatic thermal shutdown (recommended), and requiring an external enable signal.

Current settings

The motor phase current may be set to the required value using on board switches as shown below. Since the motor winding inductance may affect the actual current applied by the drive, the actual phase current applied to the motor should be checked during commissioning when the motor is in a stationary condition.

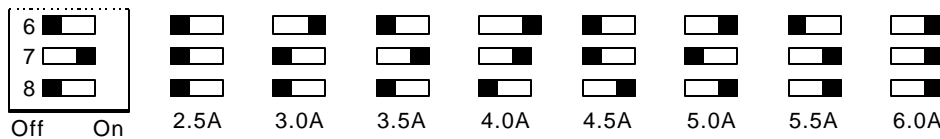

This example shows a selected current of 3.5 amps per phase.

When using greater than 4.0A, either automatic power reduction or forced air cooling is recommended.

If required, external adjustment of the set current value may be obtained by using a 10KΩ potentiometer or a resistor connected between the CURRENT ADJUST input (IA) and 0V. This will allow an adjustment range of between 25% and 80% of the current value set on the switches.

Connections using on board oscillator

A 10KΩ potentiometer should be connected externally to set the high speed.

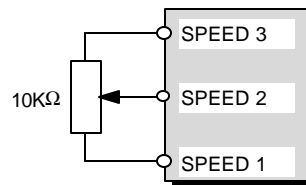

The on board oscillator may be controlled by manual control switches. This example uses three push buttons;

If movement at base speed is not required, then the high speed switch may be replaced by a link.

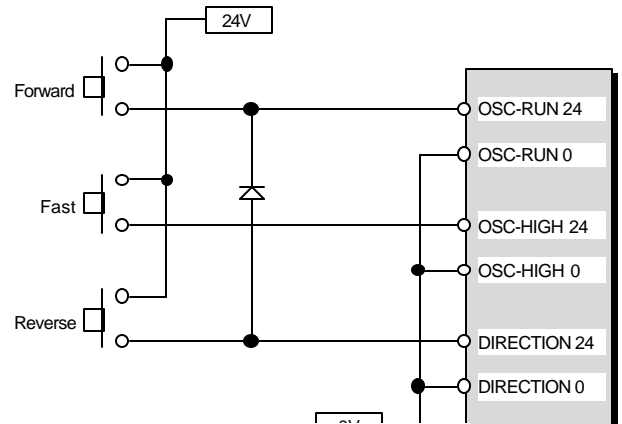

Type without front panel		panel fitted as standard	Notes
Type with front panel		PM 546	
Supply voltage	Vdc	24-85	Max ripple: 3 V peak/peak
Current consumption	Amps	2.0 to 4.0	Depending on motor current selected
Output stage		2 phase Bi-polar	
Output current per phase	Amps	2.5 to 6.0	set by on-board DIP switch
Step logic		Full step / Half step	set by on-board DIP switch
Control Signals	Vdc	3-5 or 10-30	optically isolated
External current setting		25 - 90%	using external 10K Ohm potentiometer
Current reduction @ standstill		typically 20 - 25%	using on-board current setting
Current reduction selection		automatic or external	set by on-board DIP switch
Thermal Warning		front panel status lamp	and output signal @ 80°C
Thermal shutdown		automatic or external	set by on-board DIP switch
Enable / inhibit		External signal	sense set by on-board DIP switch
Direction		External signal	sense set by on-board DIP switch
External Clock signal		one step per pulse	Opto-isolated input
Max input frequency	KHz	20	6 µsec. minimum pulse width
Internal clock functions			Opto-isolated inputs
Low frequency range (BASE)	KHz	0.002 to 0.7	set by front panel trimmer
Slew frequency range (HIGH)	KHz	0.6 to 18	set by external 10 K Ohm potentiometer
Acceleration/ decel. RAMP		adjustable	set by front panel trimmer
Auto-Ramp on reverse signal		standard	set by on board DIP switch
Front panel Status Lamp		Green Yellow Red	Drive OK. & enabled Drive not enabled Fault: Over temperature / Over current
Status output signal	mA	10 max.	Optically isolated: ON when OK
Operating ambient temperature	°C	0-30	Use forced cooling for operation at higher temperatures
Dimensions	mm	228 long x 100 x 34	Uses 3U x 7E wide front panel
Recommended Motherboard		MSB543	

Power Supply considerations

Standard drive current settings	2.5 A	3.0 A	3.5A	4.0 A	4.5 A	5.0 A	5.5 A	6.0 A
Typical Current Consumption	1.5 A	2.0 A	2.5 A	2.7 A	3.0 A	3.2 A	3.6 A	4.0 A
Typical Standby Current	0.9 A	0.9 A	0.9 A	1.0 A	1.0 A	1.2 A	1.2 A	1.3 A

Typical drive / motor combinations

Motor	23HS-108	23HS-304	23HS-409	34HS-109	34HSX108 34HSX208	34HS-209	34HSX314 34HS-311
Coil Connection	coils in series	coils in parallel	coils in series	coils in parallel	coils in parallel	coils in parallel	coils in parallel
Drive setting	2.5 Amps	2.5 Amps	3.5 Amps	4.0 Amps	5.0 Amps	5.5 Amps	6.0 Amps

Recommended Racked 70 Vdc Power Supply :

PM175: 6 Amp rating for single & multi-axis installations

Performance using PM546 with 70Vdc supply

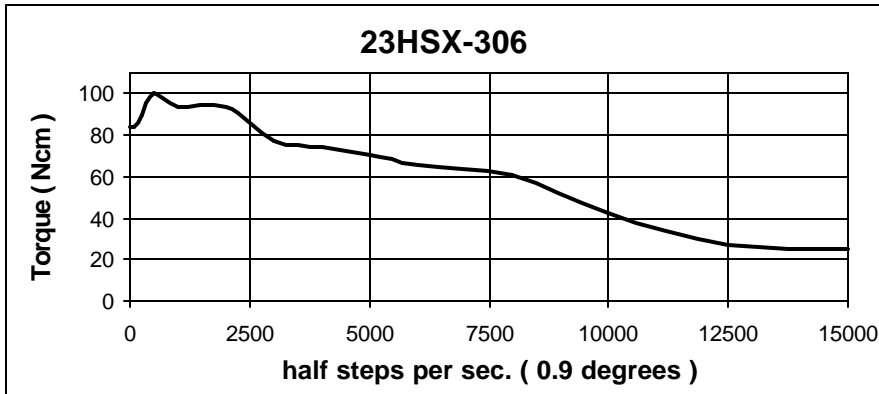

Coils in parallel, 4.0 Amps per phase



Coils in parallel, 5 amps per phase



Coils in parallel, 5 amps per phase

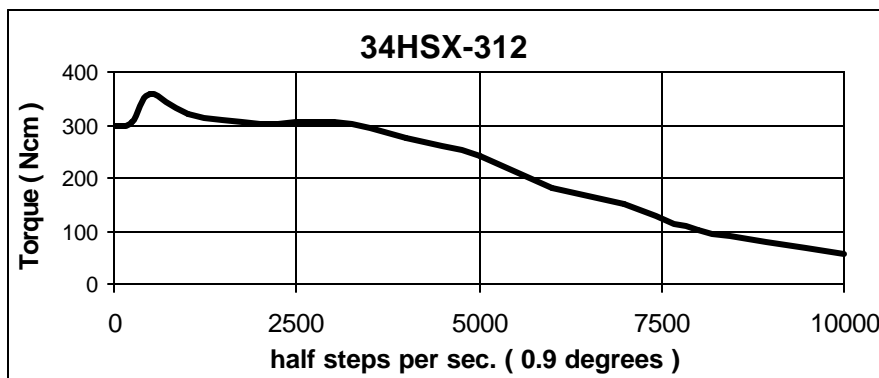

Coils in parallel, 6 amps per phase

Performance using PM546 with 70Vdc supply

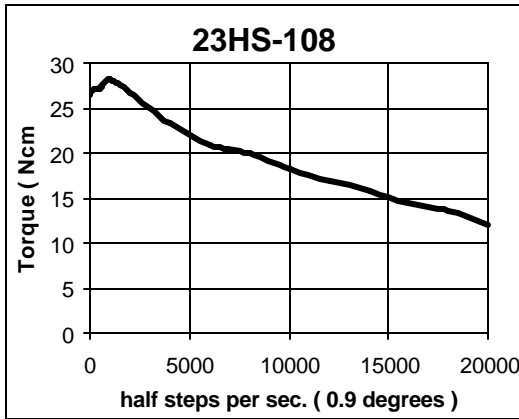

Coils in parallel, 3.5 amps per phase

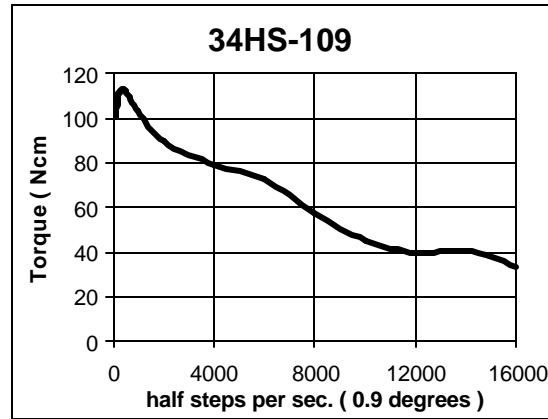

Coils in parallel, 4.5 amps per phase

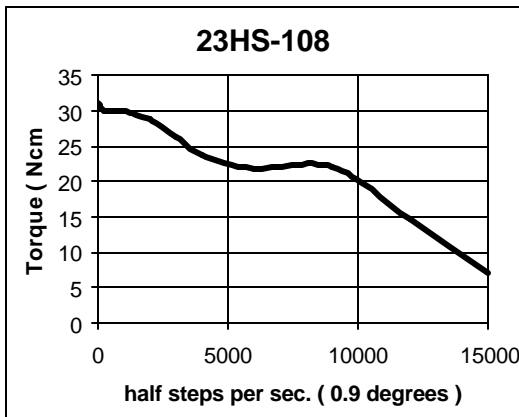

Coils in series, 2.5 amps per phase

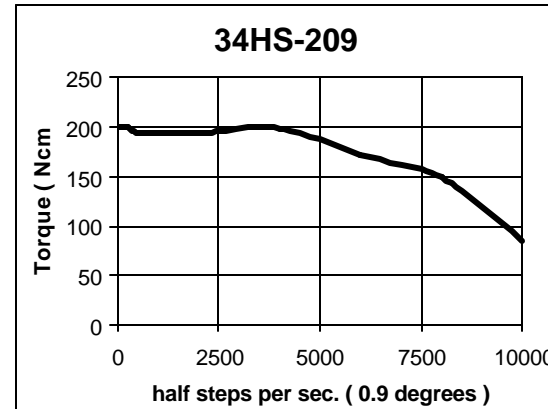

Coils in parallel, 5.5 amps per phase

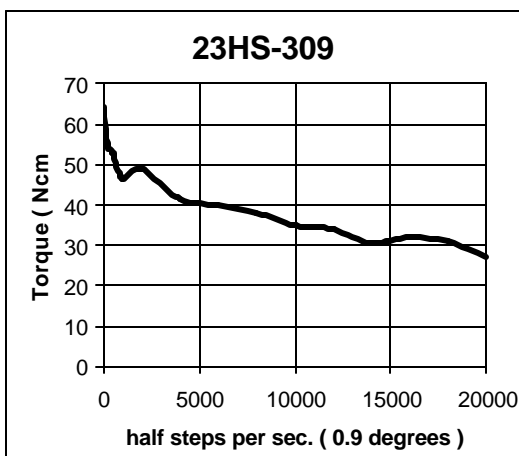

Coils in parallel, 4.0 amps per phase

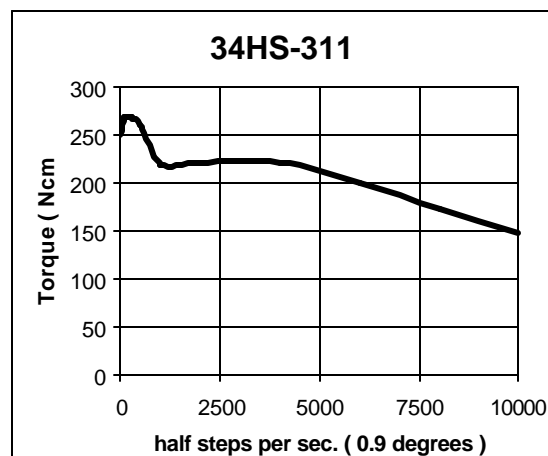

Coils in parallel, 6.0 amps per phase