

Our most popular beacon is now even better!

The New Lucas Premium Beacon



Features

- **NEW!** belt drive mechanism
- All models 12/24V*
- 4 popular mounting options
- Low profile lens
- Advanced reflector technology gives up to 20% increase in light output
- Extended 2 Year Warranty
- Available in amber, blue, red and green

* Requires belt adjustment

See over for part number guide and technical specifications





Lucas



The power to ALERT



TECHNICAL SPECIFICATIONS

1 Bolt

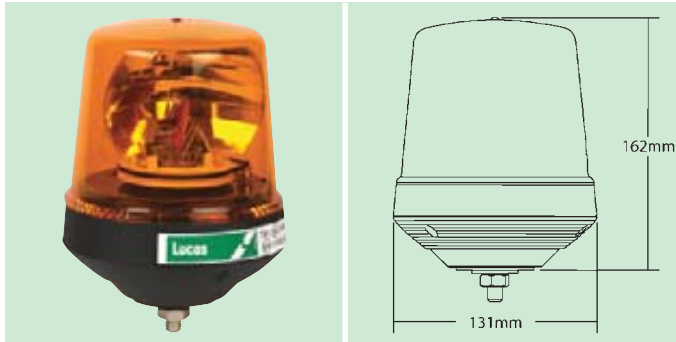
-  LBB122
amber
-  LBB122C
blue
-  LBB122R
red
-  LBB122G
green



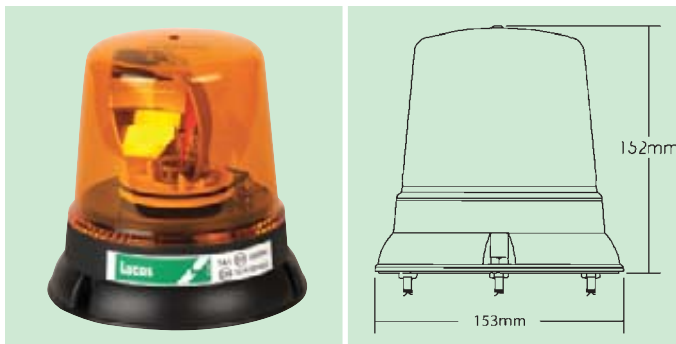

3 Bolt

-  LBB255K
amber
-  LBB255C
blue
-  LBB255R
red
-  LBB255G
green





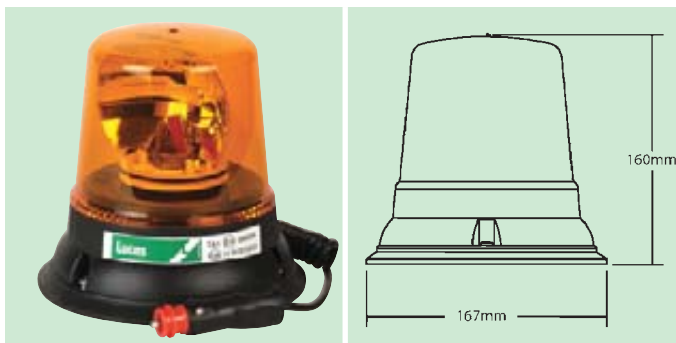

Magnetic

-  LBB260K
amber
-  LBB260C
blue
-  LBB260R
red
-  LBB260G
green



Flexi DIN

-  LBB272
amber
-  LBB272C
blue
-  LBB272R
red
-  LBB272G
green

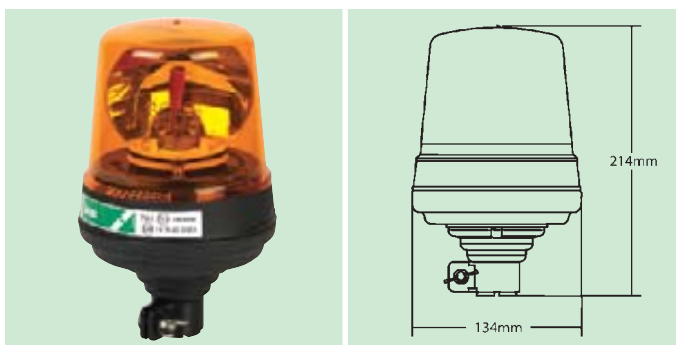

Specification

Voltage:	12/24V
Flash rate:	160 FPM
Temperature range:	-20°C to +50°C
Lens material:	Polycarbonate
Amps:	4.6A @ 12V 3.0A @ 24V
Bulb:	H1 12V 55W included

Approvals

ECE Reg 65 'E' (amber only)

ECE Reg 10 'E'

Lucas



The power to ALERT

Lucas Warning & Safety
Victoria Industrial Estate
Victoria Road
Leeds
LS14 2LA
Tel: 0870 608 0763
Fax: 0113 237 5630