

PART NUMBER

AW4P

DIMENSIONS

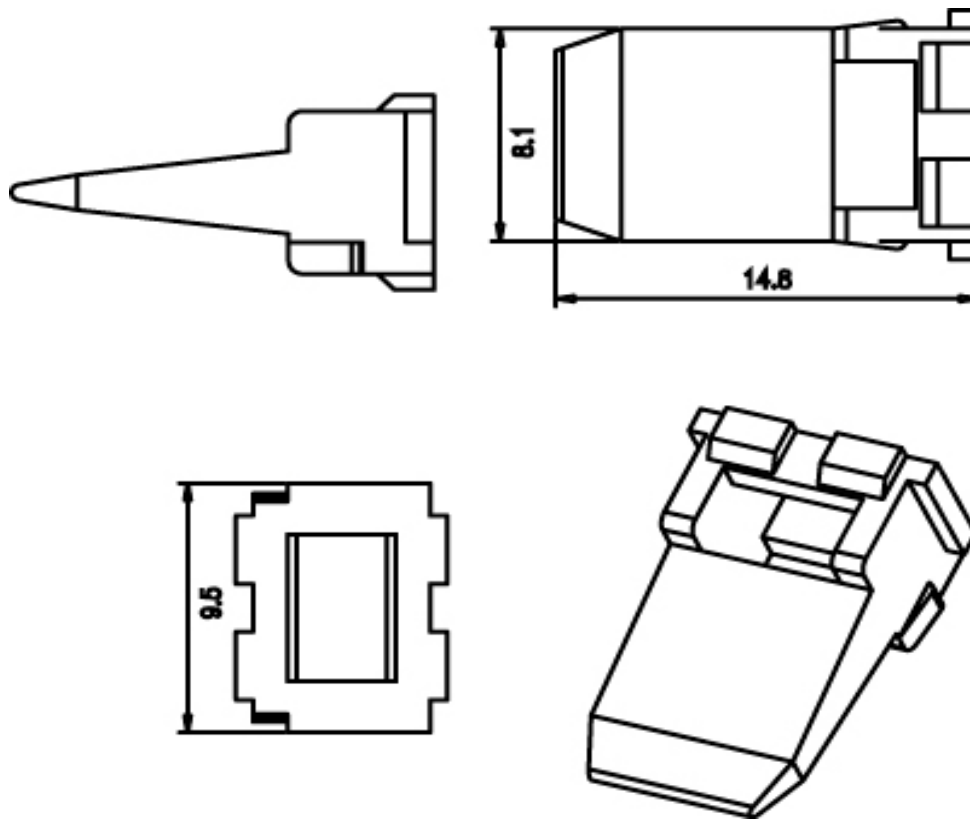

All measurements are in millimeters.

NOTES:

HOUSING COLOR	GREEN
MATING CONNECTOR:	AT04-4P
REV: NC	UNCONTROLLED DOCUMENT
DATE 23-MARCH-2009	INFORMATION SUBJECT TO CHANGE WITHOUT NOTICE

© 2009 Amphenol Sine Systems Corporation. Every effort has been made to ensure that the information contained in this document is accurate at the time of publication. Specifications or information stated in this publication are subject to change without notice.