

- ◆ **Low Power Consumption** : 25 μ A (TYP)
- ◆ **Output Current** : 150 mA ($V_{OUT} < 1.7V$)
240 mA ($V_{OUT} \geq 1.8V$)
(300mA limit)
- ◆ **Dropout Voltage** : 60mV ($I_{OUT}=30mA$)
200mV ($I_{OUT}=100mA$)
- ◆ **Output Current** : More than 150 mA (300mA limit)
- ◆ **Highly Accurate** : $\pm 2\%$ ($\pm 30mV$ when $V_{OUT}=1.5V$)
- ◆ **Output Voltage Range** : 0.9V ~ 5.0 V (50mV Step)
- ◆ **Low ESR capacitor compatible**

■ General Description

The XC6219 series are highly accurate, low noise, CMOS LDO Voltage Regulators. Offering low output noise, high ripple rejection ratio, low dropout and very fast turn-on times, the XC6219 series is ideal for today's cutting edge mobile phone.

Internally the XC6219 includes a reference voltage source, error amplifiers, driver transistors, current limiters and phase compensators. The XC6219's current limiters' foldback circuit also operates as a short protect for the output current limiter and the output pin.

The output voltage is set by laser trimming. Voltages are selectable in 50mV steps within a range of 0.9V to 5.0V. The XC6219 series is also fully compatible with low ESR ceramic capacitors, reducing cost and improving output stability. This high level of output stability is maintained even during frequent load fluctuations, due to the excellent transient response performance and high PSRR achieved across a broad range of frequencies.

The CE function allows the output of regulator to be turned off, resulting in greatly reduced power consumption.

The XC6219 series is available in the SOT-23-5, SOT-89 or USP-6B 'chip-scale' package. Measuring only 2.0mm x 1.8mm the USP-6B is perfect for applications where PCB area is critical.

■ Applications

- Mobile phones
- Cordless phones and radio communication equipment
- Portable games
- Cameras, Video recorders
- Reference Voltage Source
- Battery Powered Equipment

■ Features

Maximum Output Current	: 150 mA ($V_{OUT} < 1.7V$) 240 mA ($V_{OUT} \geq 1.8V$) (300mA limit)
Dropout Voltage	: 200mV ($I_{OUT}=100mA$)
Operating Voltage Range	: 2.0V ~ 6.0V
Output Voltage Range	: 0.9V ~ 5.0V (50mV Step)
Highly Accurate	: $\pm 2\%$ ($V_{OUT}>1.5V$) : $\pm 30mV$ ($V_{OUT}\leq 1.5V$)
Low Power Consumption	: 25 μ A (TYP.)
Standby Current	: Less than 0.1 μ A (TYP.)
High Ripple Rejection	: 65dB (10kHz)
Operating Temperature Range	: -40°C ~ +85°C
Low ESR Capacitor Compatible	: Ceramic capacitor
Ultra Small Packages	: SOT-23-5 SOT-89 USP-6B

■ Typical Applications

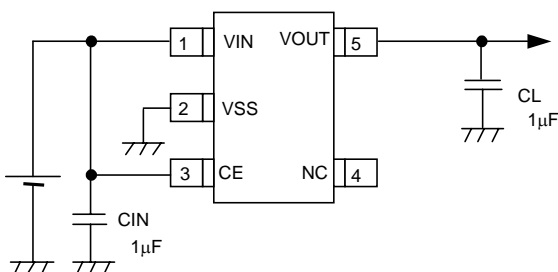

Pin Configuration

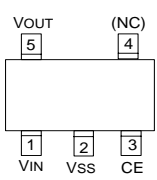

SOT-25
(SOT-23-5)
[TOP VIEW]

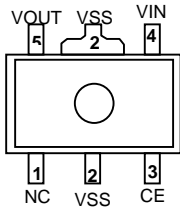

SOT-89
[TOP VIEW]

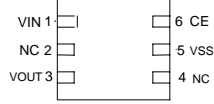

USP-6B
[TOP VIEW]

Pin Assignment

PIN NUMBER			PIN NAME	FUNCTION
SOT-25	SOT-89	USP-6B		
1	4	1	VIN	Input
2	2	5	VSS	Ground
3	3	6	CE	ON/OFF Control
4	1	2, 4	NC	No Connection
5	5	3	VOUT	Output

Block Diagram

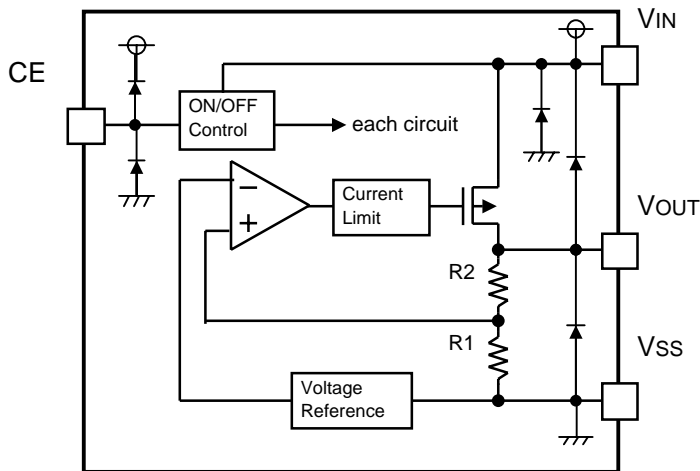

Product Classification

Selection Guide

The following options for the CE pin logic and internal pull-up/down are available:

Active 'High' + no pull-down resistor built-in (standard)

Active 'High' + 2.0MΩ pull-down resistor built-in <between CE-VSS> (semi-custom)

Active 'Low' + no pull-up resistor built-in (semi-custom)

Active 'Low' + 2.0MΩ pull-up resistor built-in <between VIN-CE> (semi-custom)

Note: *With the pull-up resistor or pull-down resistor built-in types,

the supply current during operation will increase by $V_{IN} / 2.0M\Omega$ (TYP.)

Ordering Information XC6219①②③④⑤⑥

DESIGNATOR	SYMBOL	DESCRIPTION
①		CE Pin Logic :
	A	Active 'High' (pull-down resistor built in)
	B	Active 'High' (no pull-down resistor built in)
	C	Active 'Low' (pull-up resistor built in)
	D	Active 'Low' (no pull-up resistor built in)
② ③	Integer	Output Voltage : e.g. ②=3, ③=0, ⇒ 3.0V
④	2	Output Voltage: 100mV increments, ±2% accuracy e.g. ②=2, ③=8, ④=2 ⇒ 2.80V, ±2%
	A	Output Voltage : 50mV increments, ±2% accuracy e.g. ②=2, ③=8, ④=A ⇒ 2.85V
⑤		Package Type :
	M	SOT-25 (SOT-23-5)
	P	SOT-89
	D	USP - 6B
⑥		Device Orientation :
	R	Embossed Tape : Standard Feed
	L	Embossed Tape : Reverse Feed

Absolute Maximum Rating

Ta = 25°C

PARAMETER	SYMBOL	RATINGS	UNITS
Input Voltage	VIN	7.0	V
Output Current	IOUT	500	mA
Output Voltage	VOUT	VSS -0.3 ~ VIN +0.3	V
CE Pin Voltage	VCE	VSS -0.3 ~ VIN +0.3	V
Power Dissipation	SOT-25 (SOT-23-5)	Pd	250
	SOT-89		500
	USP-6B		100
Operating Ambient Temperature	Topr	-40 ~ +85	°C
Storage Temperature	Tstg	-55 ~ +125	°C

Electrical Characteristics XC6219B Series

Ta=25°C

PARAMETER	SYMBOL	CONDITIONS	MIN	TYP	MAX	UNITS	CIRCUIT
Output Voltage	VOUT (E)	IOUT=30mA	× 0.98	VOUT(T)	× 1.02	V	1
Maximum Output Current	IOUTMAX	* 1	150			mA	1
Load Regulation	ΔVOUT	1mA≤IOUT≤100mA		15	50	mV	1
Dropout Voltage	Vdif1	IOUT=30mA	E-1			mV	1
	Vdif2	IOUT=100mA	E-2			mV	
Supply Current	IDD	VCE=VIN		25	50	μA	2
Standby Current	Istby	VCE=VSS		0.01	0.10	μA	2
Line Regulation	ΔVOUT / ΔVIN · VOUT	VOUT(T)+1.0V≤VIN≤7.0V IOUT=30mA		0.01	0.20	% / V	1
Input Voltage	VIN		2.0		6.0	V	-
Output Voltage Temperature Characteristics	ΔVOUT / ΔTopr · VOUT	IOUT=30mA -40°C≤Topr≤85°C		100		ppm/°C	1
Ripple Rejection Rate	PSRR	IOUT=50mA, f=10kHz		65		dB	4
Current Limiter	Ilim			300		mA	1
Short-circuit Current	Ishort			50		mA	1
EN "High" Voltage	VCEH		1.60		VIN	V	1
EN "Low" Voltage	VCEL				0.25	V	2
EN "High" Current	ICEH	VCE=VIN	-0.10		0.10	μA	2
EN "Low" Current	ICEL	VCE=VSS	-0.10		0.10	μA	2

NOTE

*1 : 150mA (VOUT<1.7V), 240mA (VOUT≥1.8V)

(NOTE 1) VOUT(T)=Specified Output Voltage

(NOTE 2) VOUT(E)=Effective Output Voltage

(I.e. the output voltage when "VOUT(T)+1.0V" is provided at the VIN pin while maintaining a certain IOUT value).

(NOTE 3) Vdif={VIN1(NOTE5)-VOUT1(NOTE4)}

(NOTE 4) VOUT1=A voltage equal to 98% of the Output Voltage whenever an amply stabilized IOUT {VOUT(T)+1.0V} is input.

(NOTE 5) VIN1=The Input Voltage when VOUT1 appears as Input Voltage is gradually decreased.

(NOTE 6) Unless otherwise stated, VIN=VOUT(T)+1.0V

Dropout Voltage

SYMBOL	E-1			E-2		
	Vdif 1			Vdif 2		
PARAMETER	MIN	TYP	MAX	MIN	TYP	MAX
OUTPUT VOLTAGE						
0.90	1100	1100	1110	1100	1150	1200
1.50	500	500	510	500	550	600
1.80 ~ 1.85	200	200	210	200	300	400
1.90 ~ 1.95	100	120	150	100	280	380
2.00 ~ 2.05	-	80	120	-	240	350
2.10 ~ 2.25	-	80	120	-	240	330
2.30 ~ 2.45	-	80	120	-	240	310
2.50 ~ 2.75	-	70	100	-	220	290
2.80 ~ 2.95	-	70	100	-	220	270
3.00 ~ 3.05	-	60	90	-	200	270
3.10 ~ 3.95	-	60	90	-	200	250
4.00 ~ 4.95	-	60	80	-	180	230
5.00	-	50	70	-	160	210

* The input voltage 2.0V (Min.) is needed to operate the series. When the output voltage is less than 2.0V,

2.0V-VOUT(T) of dropout voltage is needed at minimum.

Test Circuits

Circuit ①

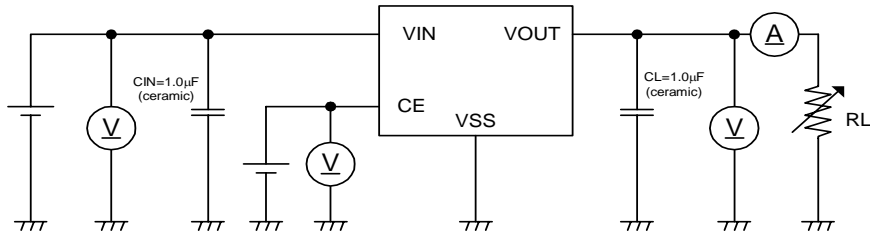

Circuit ②

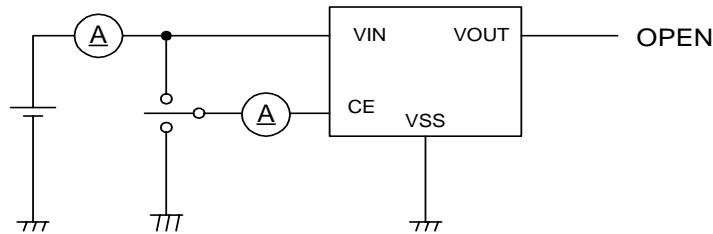

Circuit ③

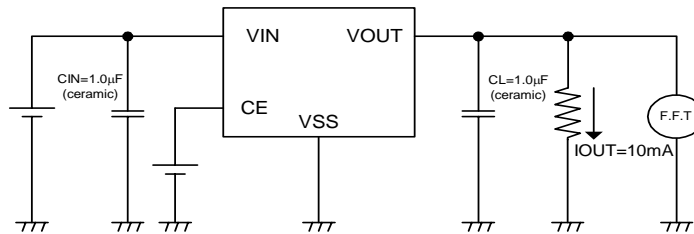

Circuit ④

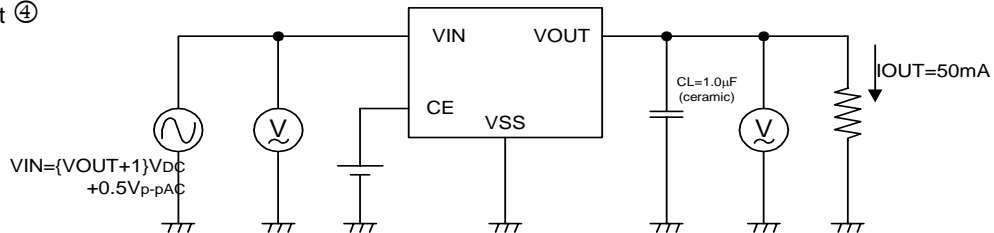

Operational Explanation

Output voltage control with the XC6219 series:

The voltage divided by resistors R1 & R2 is compared with the internal reference voltage by the error amplifier. The P-Channel MOSFET, which is connected to the VOUT pin, is then driven by the subsequent output signal. The output voltage at the VOUT pin is controlled and stabilized by a system of negative feedback. The current limit circuit and short protect circuit operate in relation to the level of output current. Further, the IC's internal circuitry can be shutdown via the CE pin's signal.

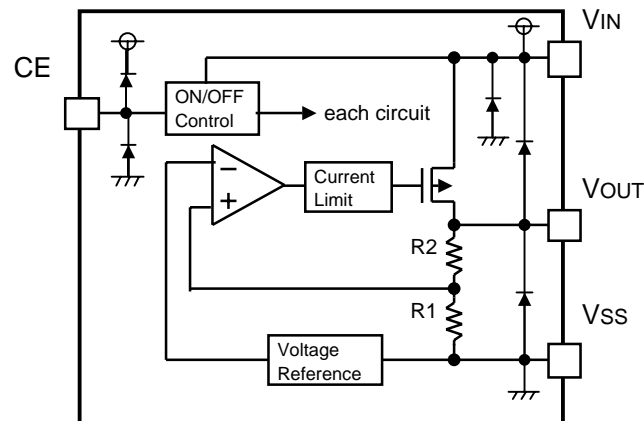

Low ESR Capacitors

With the XC6219 series, a stable output voltage is achievable even if used with low ESR capacitors as a phase compensation circuit is built-in. In order to ensure the effectiveness of the phase compensation, we suggest that an output capacitor (CL) is connected as close as possible to the output pin (VOUT) and the VSS pin. Please use an output capacitor with a capacitance value of at least 1 μ F. Also, please connect an input capacitor (CIN) of 0.1 μ F between the VIN pin and the VSS pin in order to ensure a stable power input.

Current Limiter, Short-Circuit Protection

The XC6219 series includes a combination of a fixed current limiter circuit & a foldback circuit which aid the operations of the current limiter and circuit protection. When the load current reaches the current limit level, the fixed current limiter circuit operates and output voltage drops. As a result of this drop in output voltage, the foldback circuit operates, output voltage drops further and output current decreases. When the output pin is shorted, a current of about 50mA flows.

CE Pin

The IC's internal circuitry can be shutdown via the signal from the CE pin with the XC6219 series. In shutdown mode, output at the VOUT pin will be pulled down to the VSS level via R1 & R2. The operational logic of the IC's CE pin is selectable (please refer to the selection guide on page 3). Note that as the standard XC6219B type's regulator 1 and 2 are both 'High Active/No Pull Down', operations will become unstable with the CE pin open. Although the CE pin is equal to an inverter input with CMOS hysteresis, with either the pull-up or pull-down options, the CE pin input current will increase when the IC is in operation. We suggest that you use this IC with either a VIN voltage or a VSS voltage input at the CE pin. If this IC is used with the correct specifications for the CE pin, the operational logic is fixed and the IC will operate normally. However, supply current may increase as a result of through current in the IC's internal circuitry.

Notes on Use

- 1 Please use this IC within the stated absolute maximum ratings.
The IC is liable to malfunction should the ratings be exceeded.
- 2 Where wiring impedance is high, operations may become unstable due to noise and/or phase lag depending on output current. Please keep the resistance low between VIN and VSS wiring in particular.
- 3 Please wire the input capacitor (CIN) and the output capacitor (CL) as close to the IC as possible.

■ Typical Performance Characteristics

(1) Output Voltage vs. Output Current

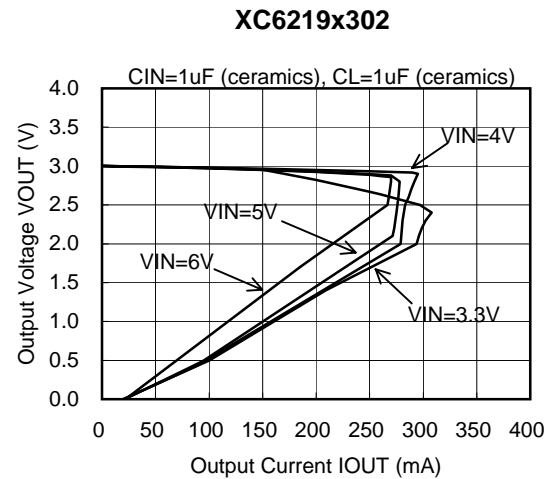
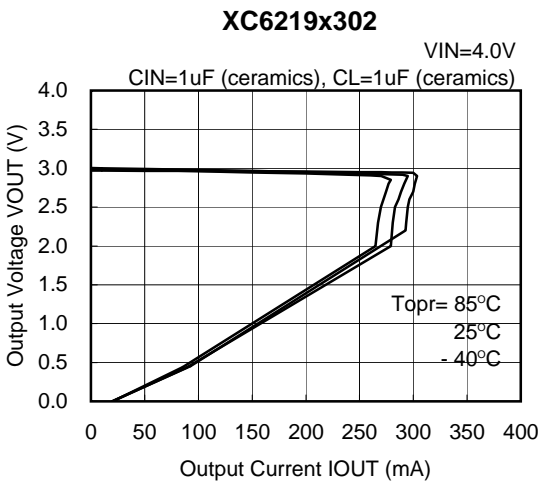
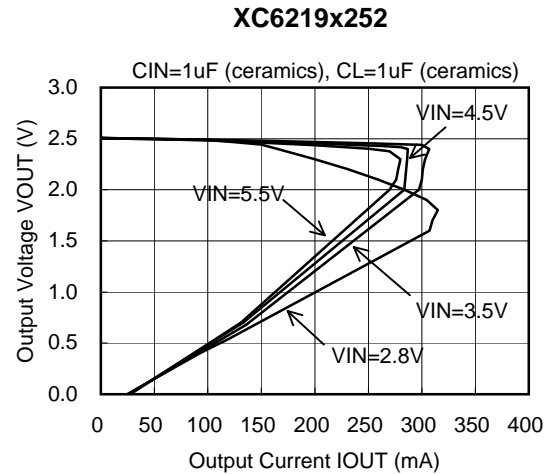
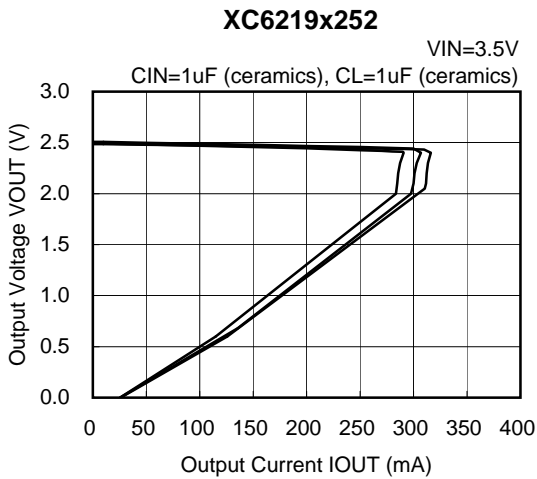
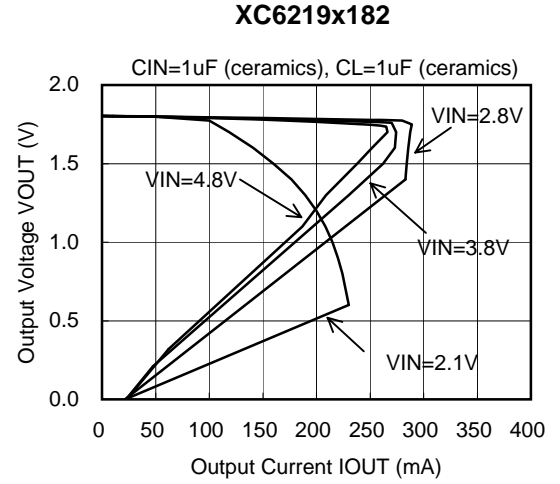
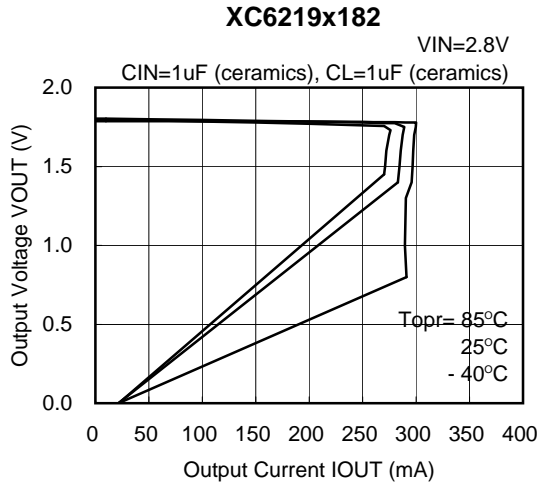

(2) Output Voltage vs. Input Voltage

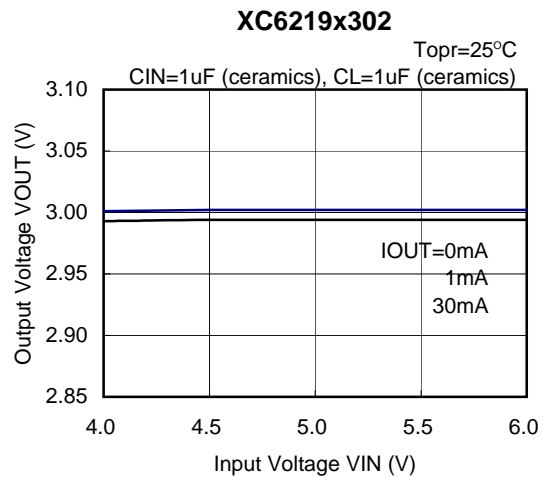
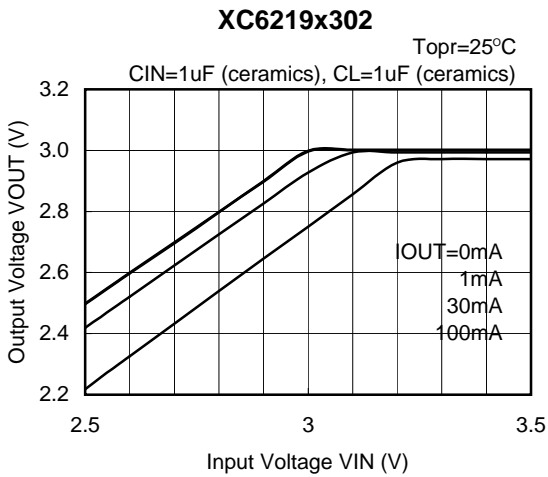
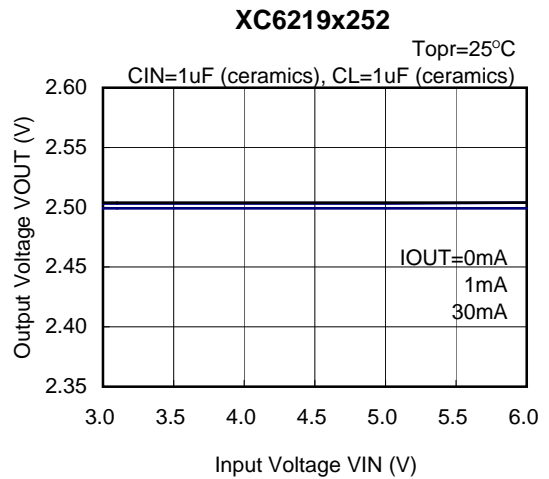
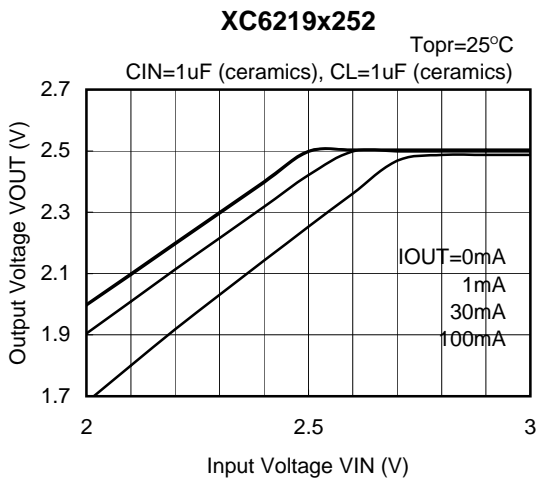
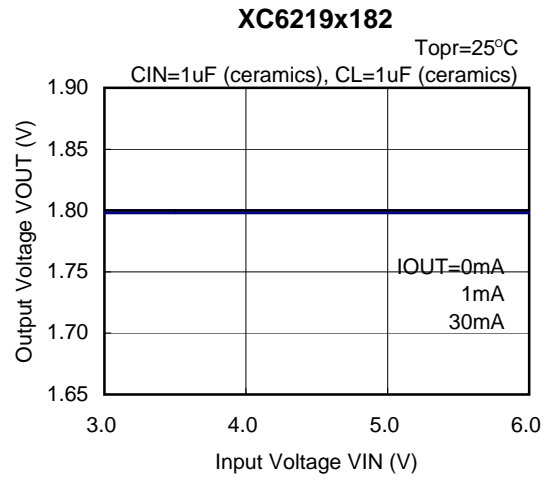
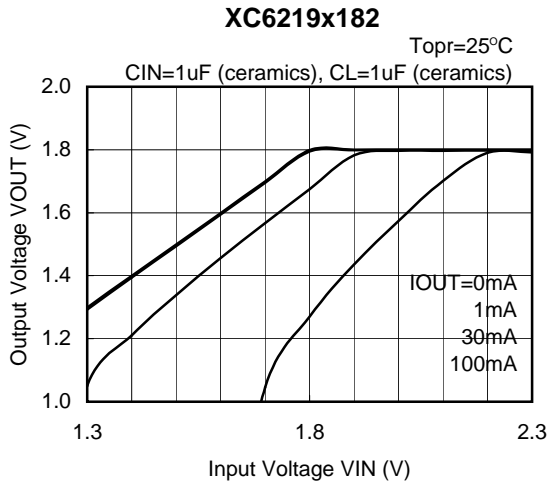

(3) Input Voltage vs. Output Current

XC6219x182

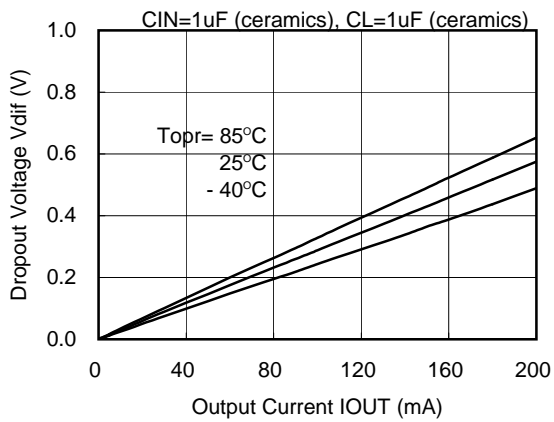

XC6219x252

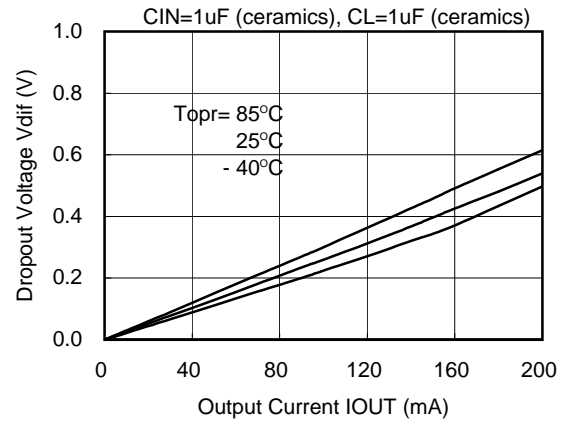

XC6219x302

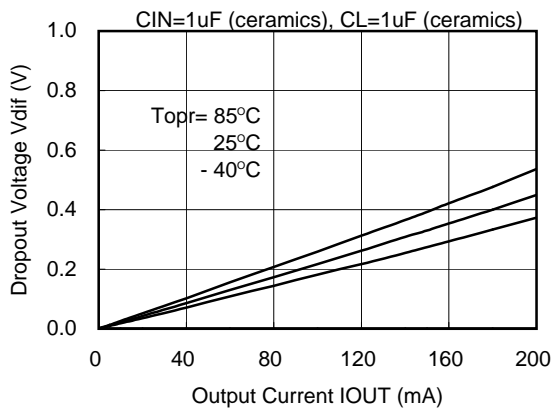

(4) Supply Current vs. Input Voltage

XC6219x182

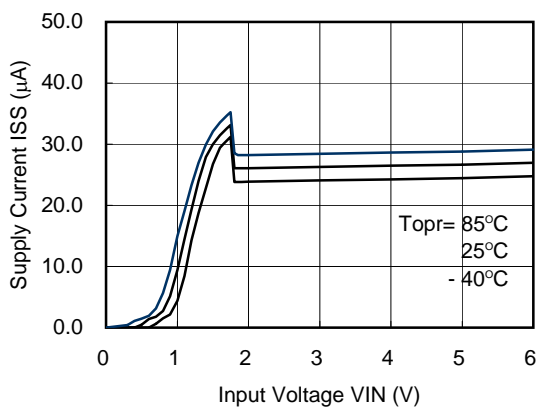

XC6219x252

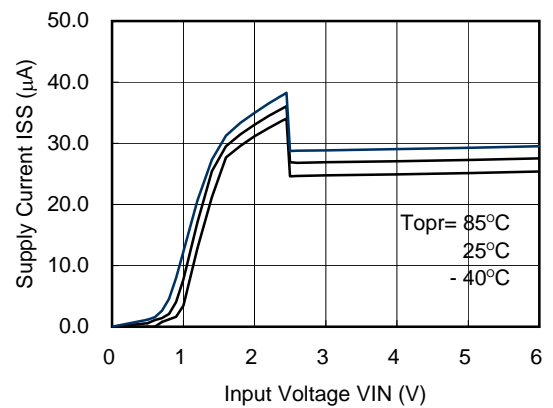

(4) Supply Current vs. Input Voltage (Continued)

XC6210x302

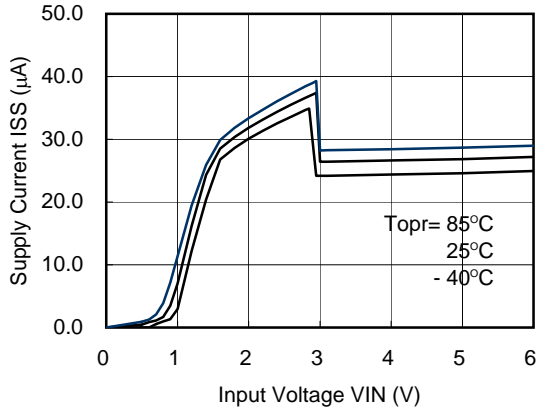

(5) Output Voltage vs. Ambient Temperature

XC6219x182

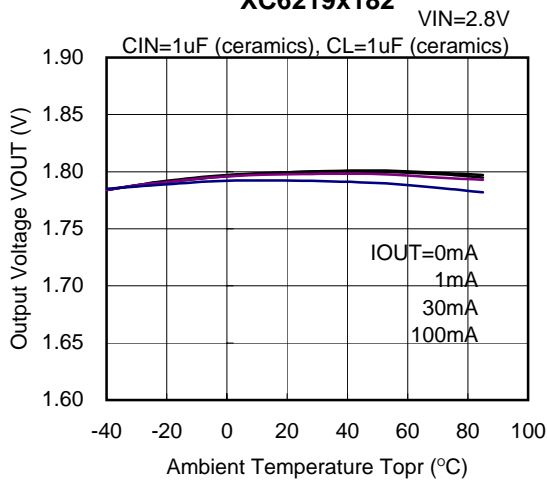

XC6219x252

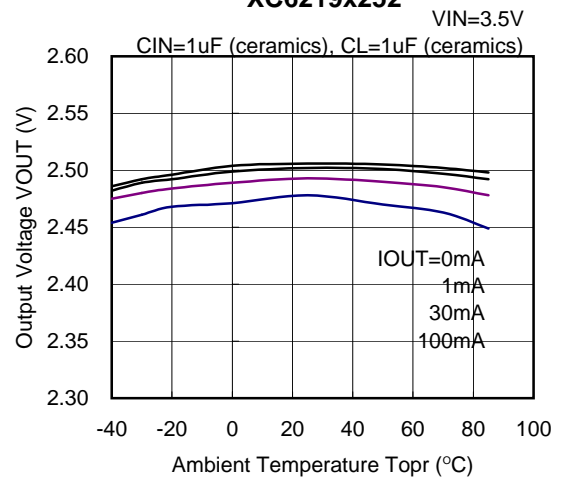

XC6219x302

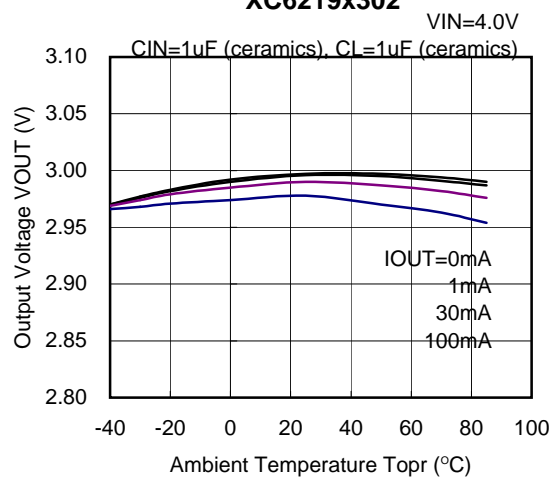

(6) Supply Current vs. Ambient Temperature

XC6219x182

VIN=2.8V

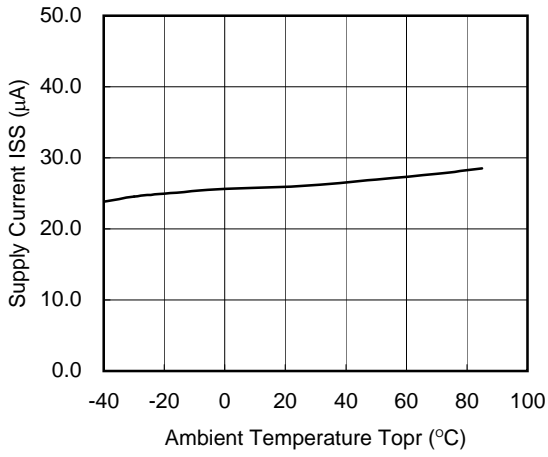

XC6219x252

VIN=3.5V

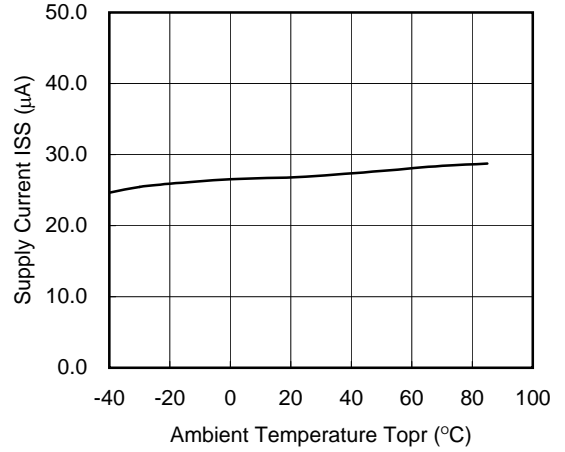

XC6219x302

VIN=4.0V

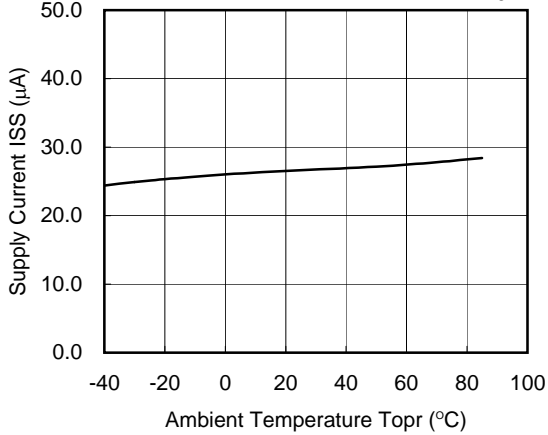

(7) Input Transient Response

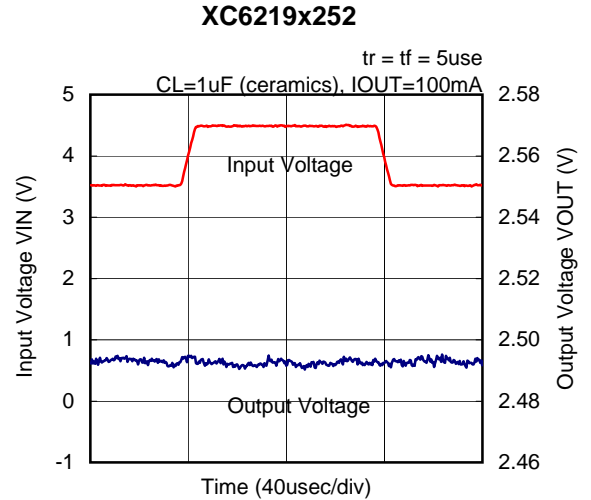
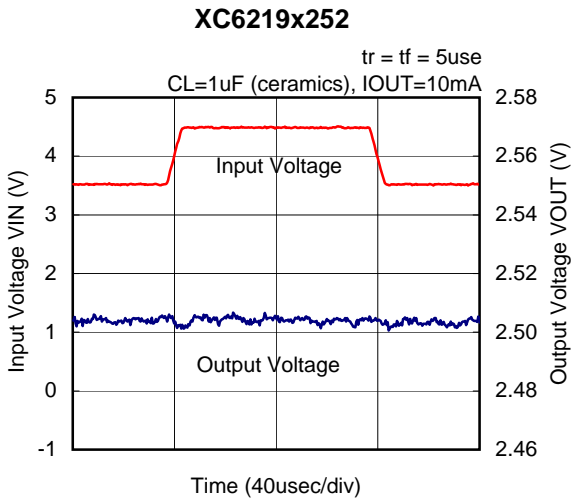
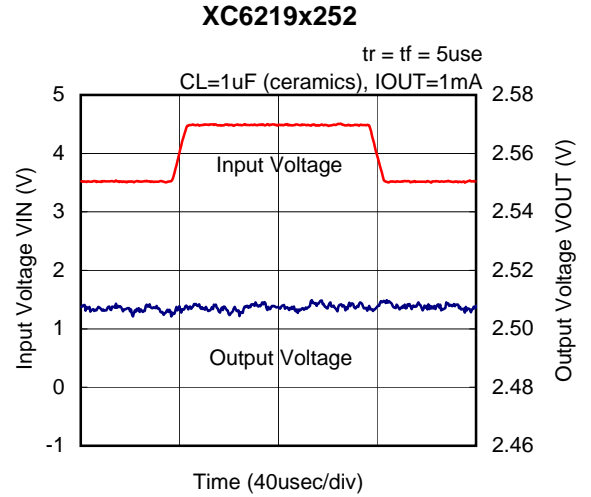
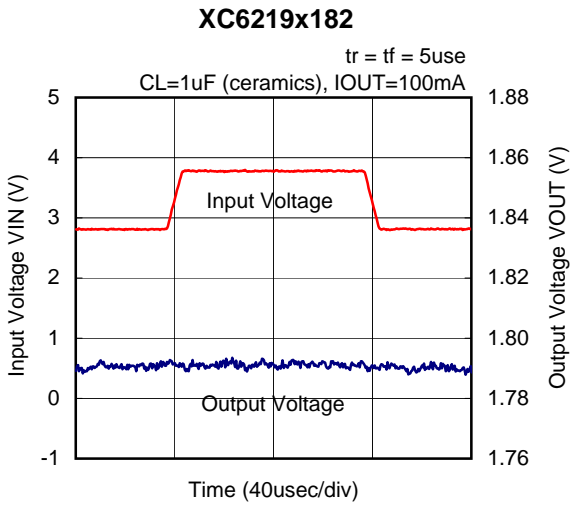
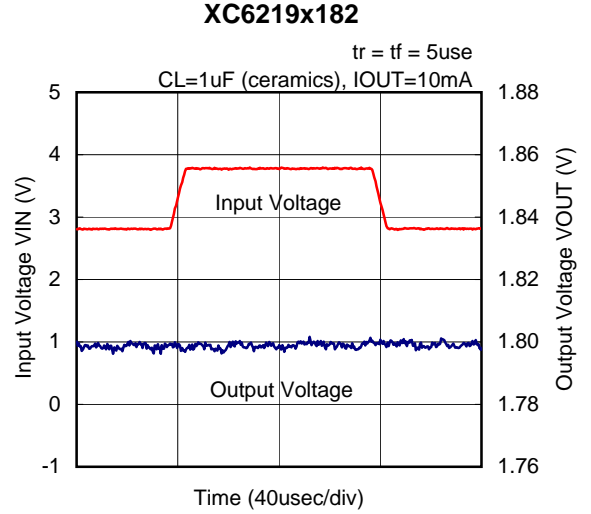
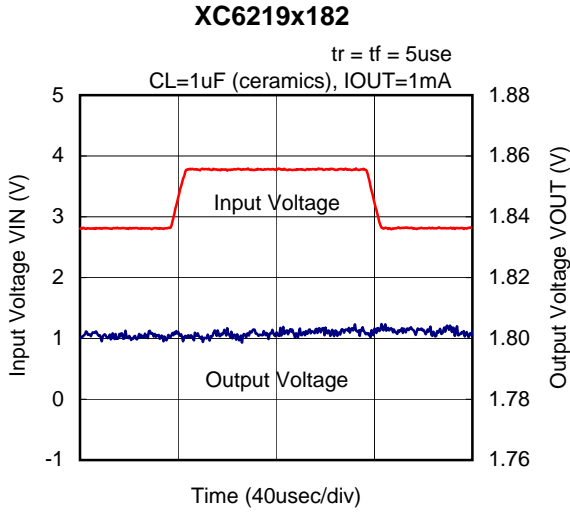

(7) Input Transient Response (Continued)

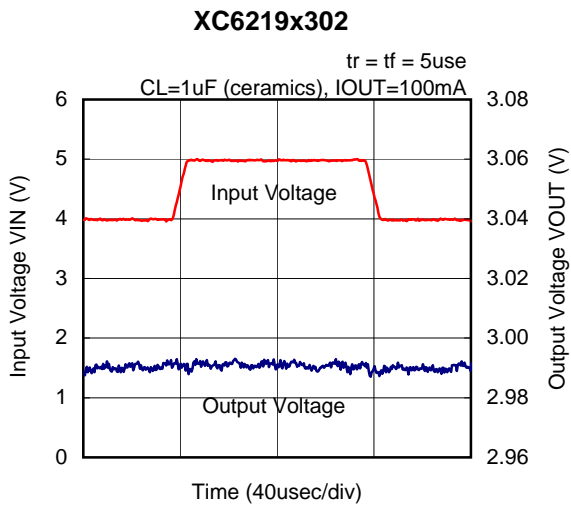
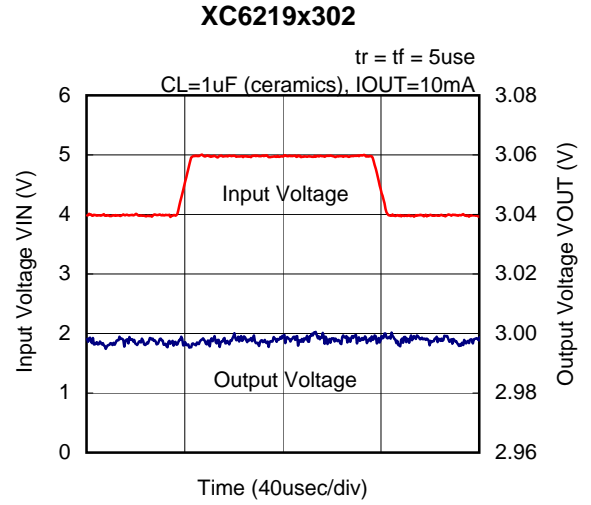
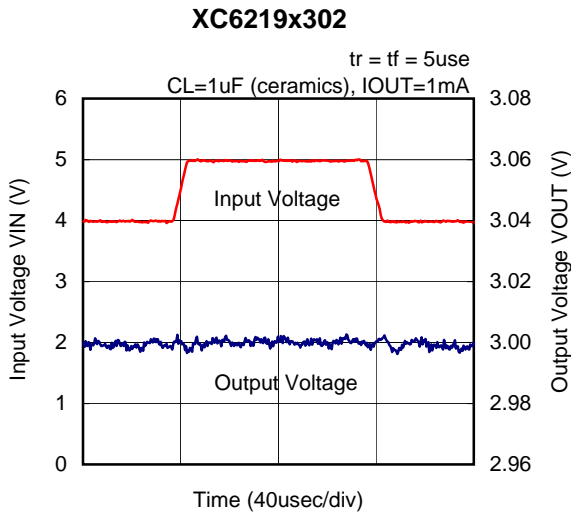

(8) Load Transient Response

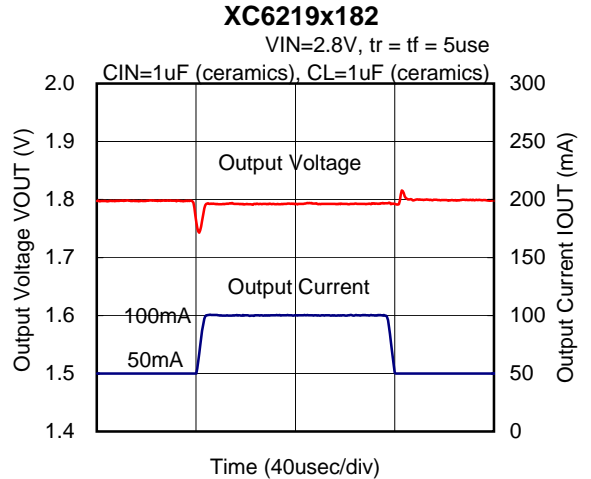
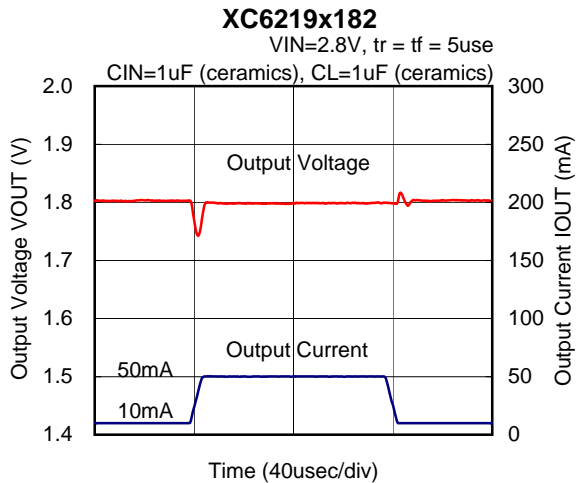

(8) Load Transient Response (Continued)

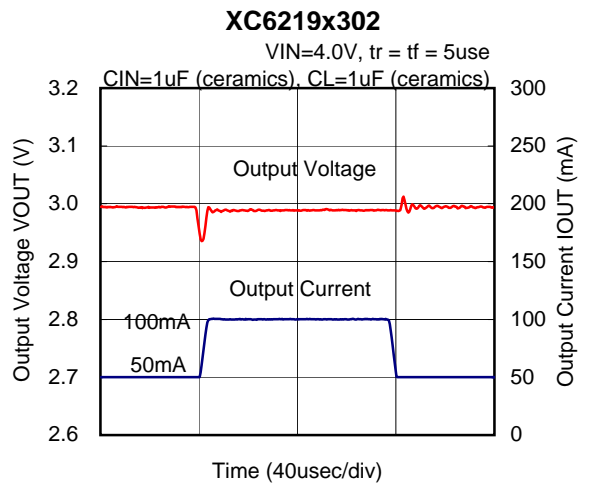
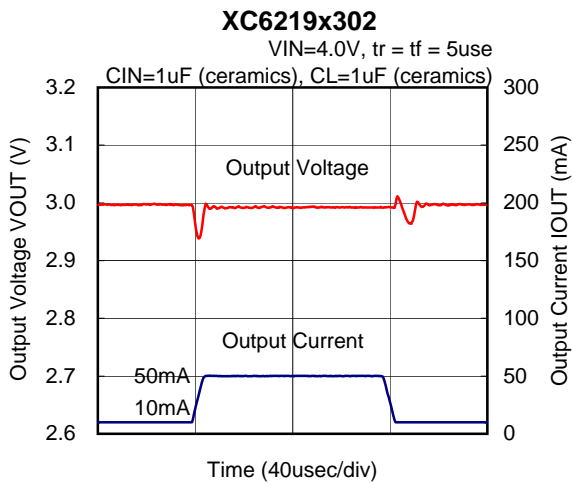
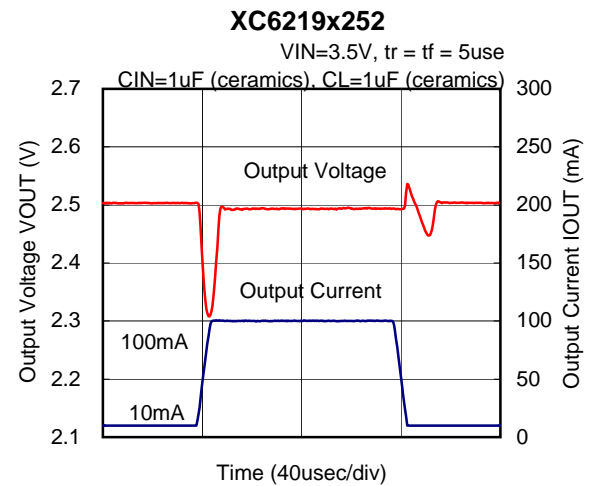
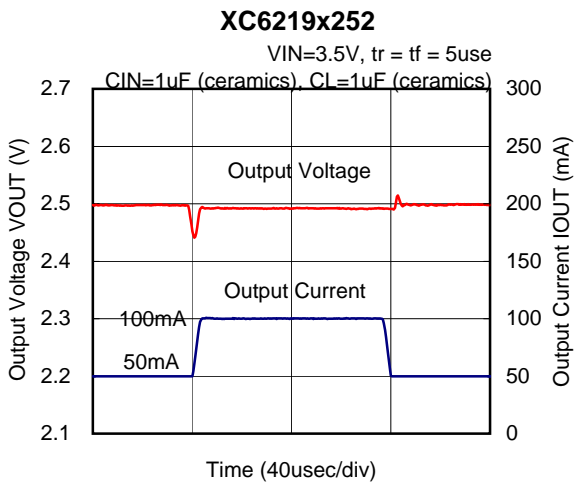
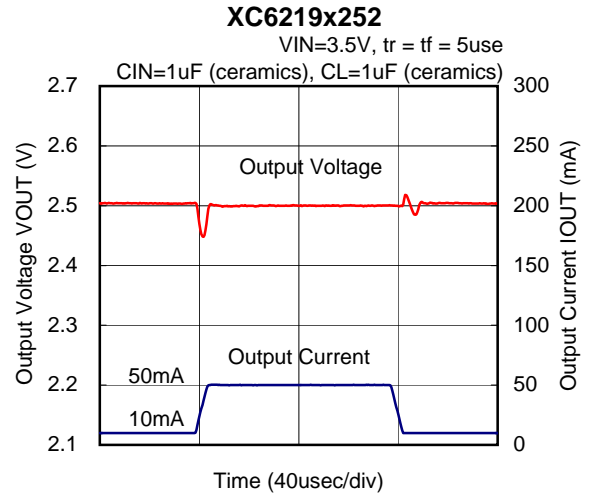
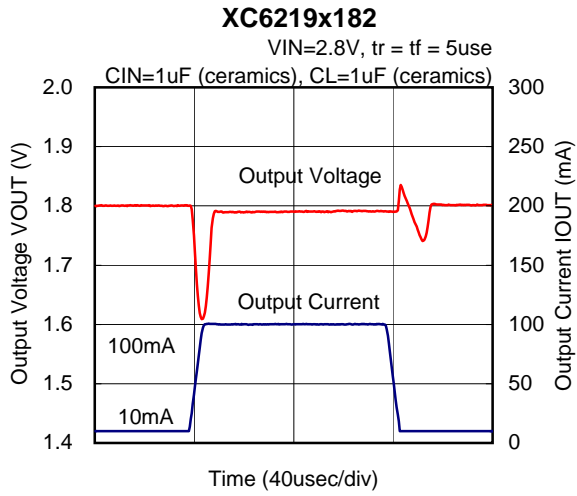

(8) Load Transient Response (Continued)

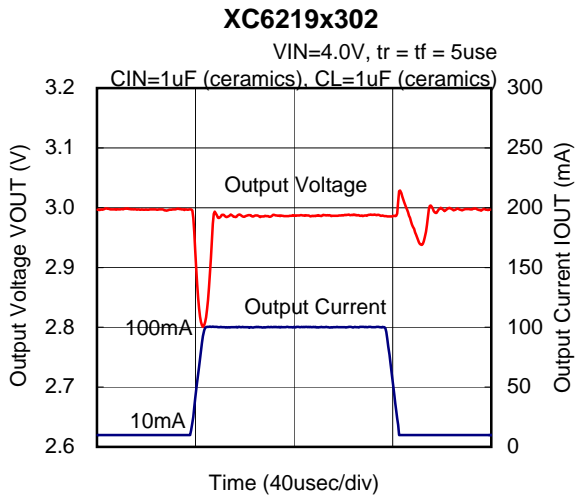

(9) Ripple Rejection Rate

