

High Intensity LED, \varnothing 5 mm Untinted Non-Diffused

Description

The TLH.51.. series is a clear, non diffused 5 mm LED for outdoor application.

These clear lamps utilize the highly developed technologies like AlInGaP and GaP.

The lens and the viewing angle is optimized to achieve best performance of light output and visibility.

The subtypes TLH.5101 and TLH.5102 with their very stable light output are especially recommended for applications where a homogeneous appearance is required.

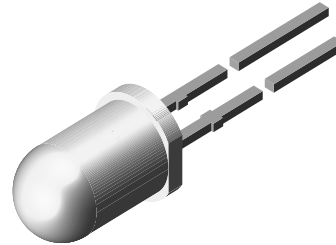

19223



Features

- Untinted non diffused lens
- Choice of four colors
- TLH.5101 and TLH.5102 with reduced light matching factor
- TLH.5100 for cost effective design
- Medium viewing angle
- Lead-free device

Applications

- Outdoor LED panels
- Central high mounted stop lights (CHMSL) for motor vehicles
- Instrumentation and front panel indicators
- Light guide design
- Traffic signals

Parts Table

Part	Color, Luminous Intensity	Angle of Half Intensity ($\pm\phi$)	Technology
TLHK5100	Red, $I_V > 320$ mcd	9 °	AllnGaP on GaAs
TLHE5100	Yellow, $I_V > 750$ mcd	9 °	AllnGaP on GaAs
TLHG5100	Green, $I_V > 240$ mcd	9 °	GaP on GaP
TLHG5101	Green, $I_V > 240$ mcd	9 °	GaP on GaP
TLHG5102	Green, $I_V > 240$ mcd	9 °	GaP on GaP
TLHP5100	Pure green, $I_V > 66$ mcd	9 °	GaP on GaP
TLHP5101	Pure green, $I_V > 66$ mcd	9 °	GaP on GaP
TLHP5102	Pure green, $I_V > 66$ mcd	9 °	GaP on GaP

Absolute Maximum Ratings

$T_{amb} = 25$ °C, unless otherwise specified

TLHK51.. , TLHE51.. , TLHG51.. , TLHP51..

Parameter	Test condition	Symbol	Value	Unit
Reverse voltage		V_R	6	V
DC Forward current	$T_{amb} \leq 65$ °C	I_F	30	mA
Surge forward current	$t_p \leq 10$ μ s	I_{FSM}	1	A
Power dissipation	$T_{amb} \leq 65$ °C	P_V	100	mW
Junction temperature		T_j	100	°C

Parameter	Test condition	Symbol	Value	Unit
Operating temperature range		T_{amb}	- 40 to + 100	°C
Storage temperature range		T_{stg}	- 55 to + 100	°C
Soldering temperature	$t \leq 5$ s, 2 mm from body	T_{sd}	260	°C
Thermal resistance junction/ambient		R_{thJA}	350	K/W

Optical and Electrical Characteristics

$T_{amb} = 25$ °C, unless otherwise specified

Red

TLHK51..

Parameter	Test condition	Part	Symbol	Min	Typ.	Max	Unit
Luminous intensity ¹⁾	$I_F = 20$ mA	TLHK5100	I_V	320			mcd
Dominant wavelength	$I_F = 10$ mA		λ_d	626	630	639	nm
Peak wavelength	$I_F = 10$ mA		λ_p		643		nm
Angle of half intensity	$I_F = 10$ mA		ϕ		± 9		deg
Forward voltage	$I_F = 20$ mA		V_F		1.9	2.6	V
Reverse voltage	$I_R = 10$ μ A		V_R	5			V
Junction capacitance	$V_R = 0$, $f = 1$ MHz		C_j		15		pF

¹⁾ in one Packing Unit $I_{Vmin}/I_{Vmax} \leq 0.5$

Yellow

TLHE51..

Parameter	Test condition	Part	Symbol	Min	Typ.	Max	Unit
Luminous intensity ¹⁾	$I_F = 20$ mA	TLHE5100	I_V	750			mcd
Dominant wavelength	$I_F = 10$ mA		λ_d	581	588	594	nm
Peak wavelength	$I_F = 10$ mA		λ_p		590		nm
Angle of half intensity	$I_F = 10$ mA		ϕ		± 9		deg
Forward voltage	$I_F = 20$ mA		V_F		2	2.6	V
Reverse voltage	$I_R = 10$ μ A		V_R	5			V
Junction capacitance	$V_R = 0$, $f = 1$ MHz		C_j		15		pF

¹⁾ in one Packing Unit $I_{Vmin}/I_{Vmax} \leq 0.5$

Green

TLHG51..

Parameter	Test condition	Part	Symbol	Min	Typ.	Max	Unit
Luminous intensity ¹⁾	$I_F = 20 \text{ mA}$	TLHG5100	I_V	240			mcd
		TLHG5101	I_V	240		480	mcd
		TLHG5102	I_V	240		640	mcd
Dominant wavelength	$I_F = 10 \text{ mA}$		λ_d	562		575	nm
Peak wavelength	$I_F = 10 \text{ mA}$		λ_p		565		nm
Angle of half intensity	$I_F = 10 \text{ mA}$		ϕ		± 9		deg
Forward voltage	$I_F = 20 \text{ mA}$		V_F		2.4	3	V
Reverse voltage	$I_R = 10 \mu\text{A}$		V_R	6	15		V
Junction capacitance	$V_R = 0, f = 1 \text{ MHz}$		C_j		50		pF

¹⁾ in one Packing Unit $I_{Vmin}/I_{Vmax} \leq 0.5$

Pure green

TLHP51..

Parameter	Test condition	Part	Symbol	Min	Typ.	Max	Unit
Luminous intensity ¹⁾	$I_F = 20 \text{ mA}$	TLHP5100	I_V	66			mcd
		TLHP5101	I_V	66		132	mcd
		TLHP5102	I_V	66		200	mcd
Dominant wavelength	$I_F = 10 \text{ mA}$		λ_d	555		565	nm
Peak wavelength	$I_F = 10 \text{ mA}$		λ_p		555		nm
Angle of half intensity	$I_F = 10 \text{ mA}$		ϕ		± 9		deg
Forward voltage	$I_F = 20 \text{ mA}$		V_F		2.4	3	V
Reverse voltage	$I_R = 10 \mu\text{A}$		V_R	6	15		V
Junction capacitance	$V_R = 0, f = 1 \text{ MHz}$		C_j		50		pF

¹⁾ in one Packing Unit $I_{Vmin}/I_{Vmax} \leq 0.5$

Typical Characteristics ($T_{amb} = 25 \text{ }^\circ\text{C}$ unless otherwise specified)

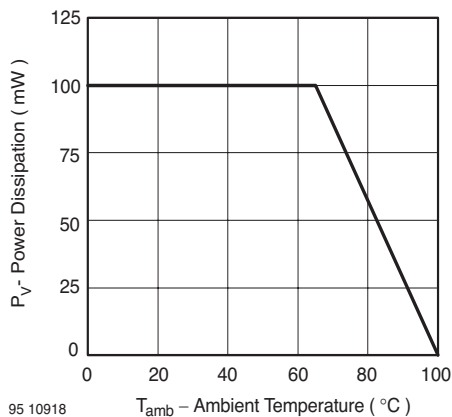

Figure 1. Power Dissipation vs. Ambient Temperature

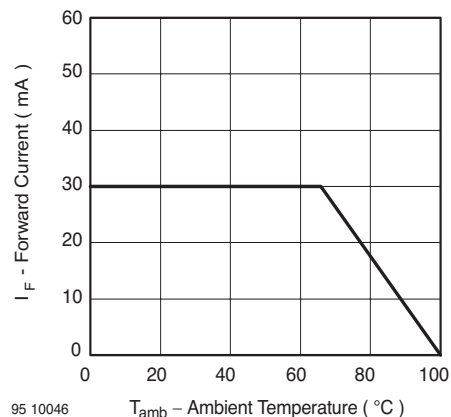

Figure 2. Forward Current vs. Ambient Temperature

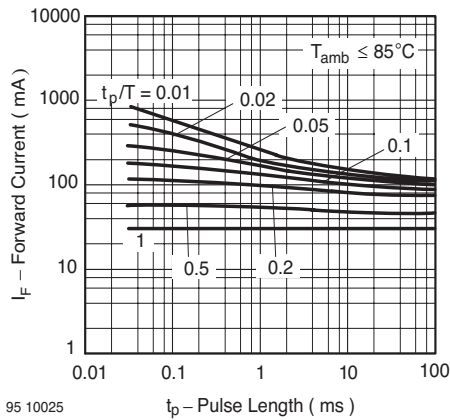

Figure 3. Forward Current vs. Pulse Length

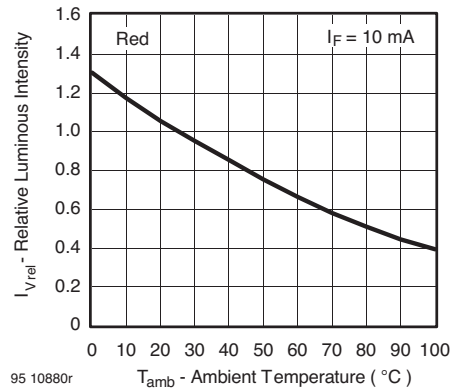

Figure 6. Rel. Luminous Intensity vs. Ambient Temperature

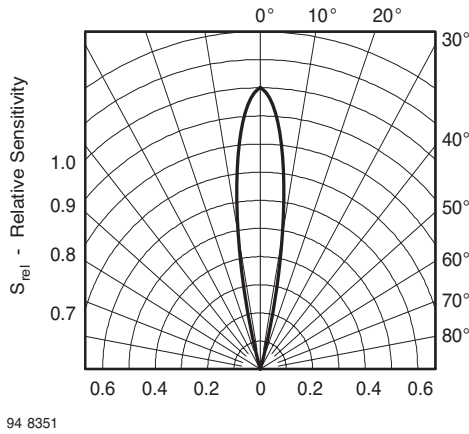

Figure 4. Relative Radiant Sensitivity vs. Angular Displacement

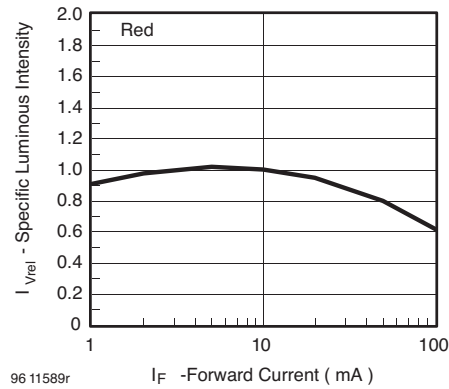

Figure 7. Specific Luminous Intensity vs. Forward Current

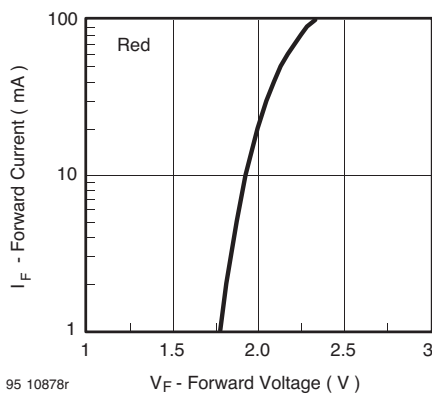

Figure 5. Forward Current vs. Forward Voltage

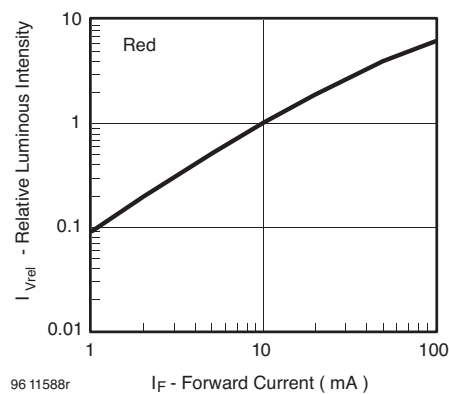

Figure 8. Relative Luminous Intensity vs. Forward Current

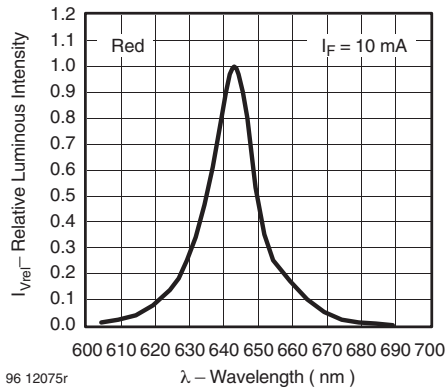

Figure 9. Relative Intensity vs. Wavelength

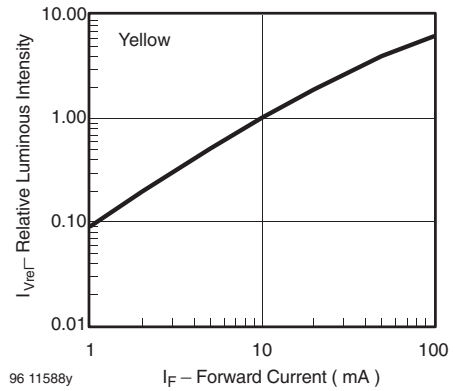

Figure 12. Relative Luminous Intensity vs. Forward Current

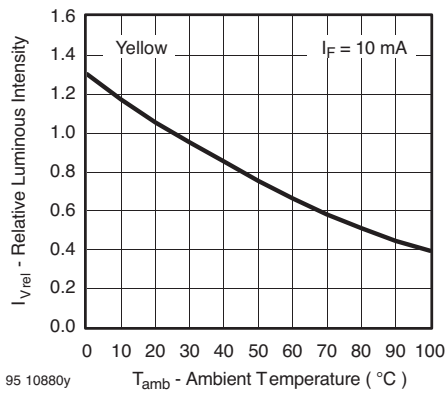

Figure 10. Rel. Luminous Intensity vs. Ambient Temperature

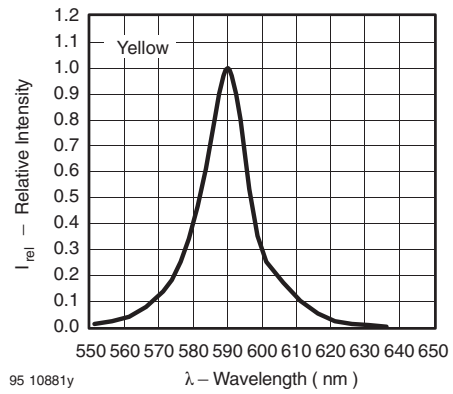

Figure 13. Relative Intensity vs. Wavelength

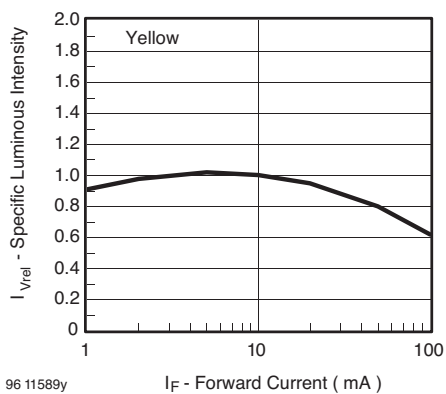

Figure 11. Specific Luminous Intensity vs. Forward Current

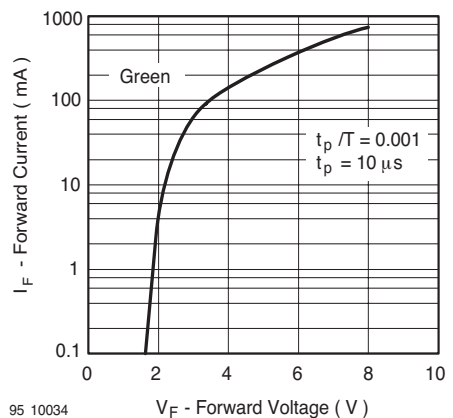

Figure 14. Forward Current vs. Forward Voltage

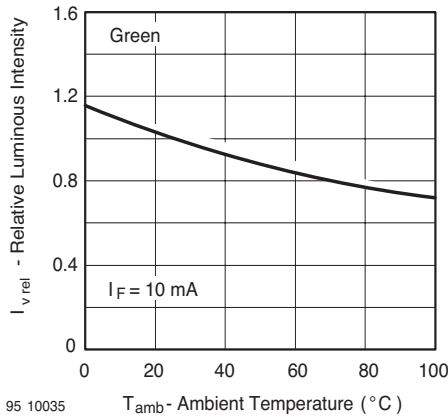

Figure 15. Rel. Luminous Intensity vs. Ambient Temperature

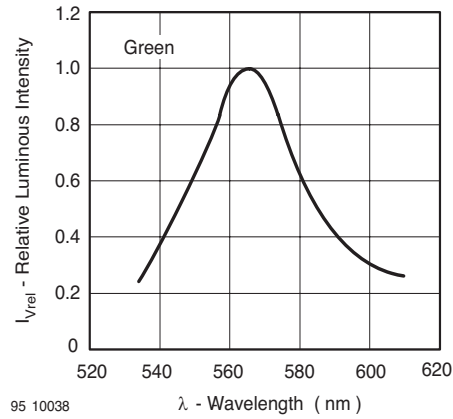

Figure 18. Relative Intensity vs. Wavelength

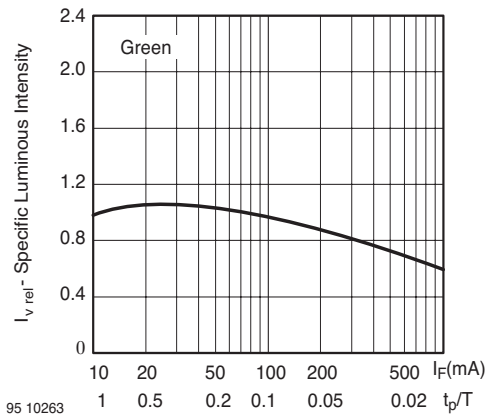

Figure 16. Specific Luminous Intensity vs. Forward Current

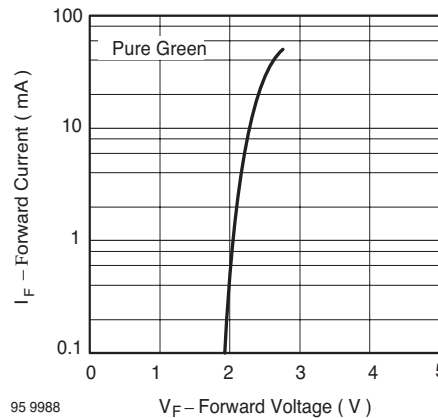

Figure 19. Forward Current vs. Forward Voltage

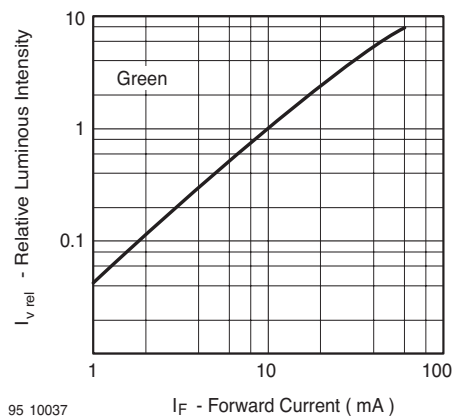

Figure 17. Relative Luminous Intensity vs. Forward Current

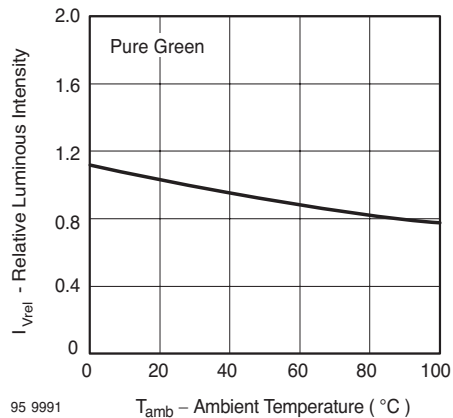

Figure 20. Rel. Luminous Intensity vs. Ambient Temperature

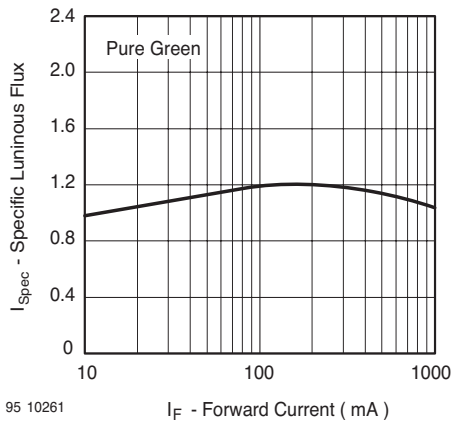

Figure 21. Specific Luminous Intensity vs. Forward Current

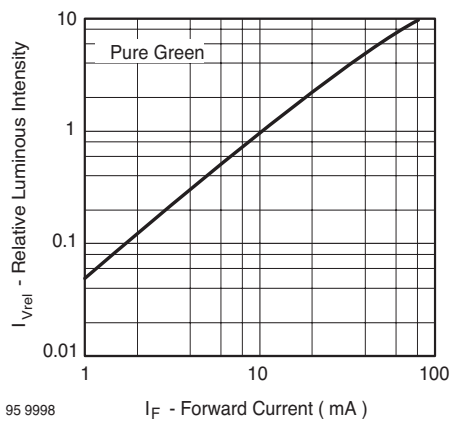

Figure 22. Relative Luminous Intensity vs. Forward Current

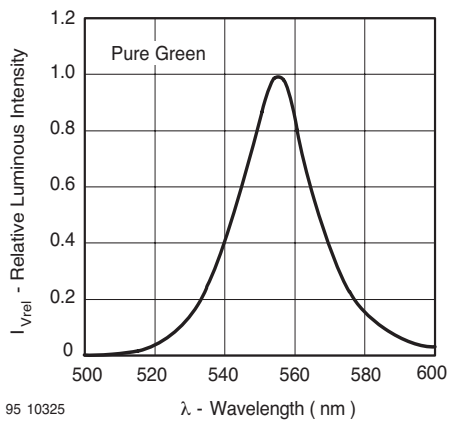
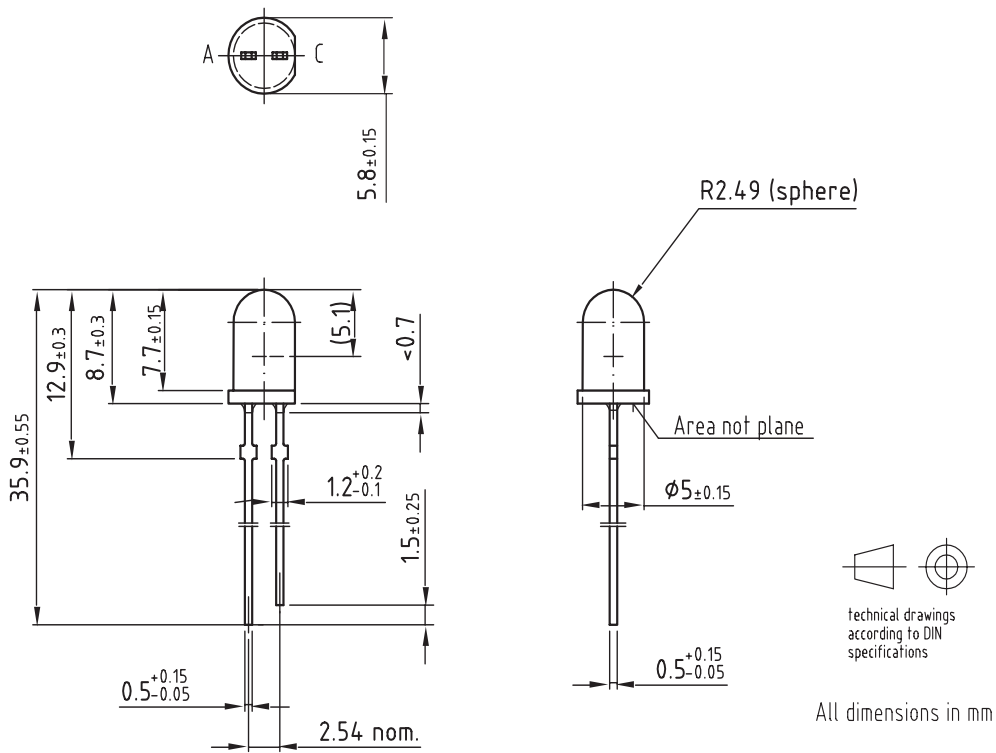

Figure 23. Relative Intensity vs. Wavelength

Package Dimensions in mm



Drawing-No.: 6.544-5258.04-4
Issue: 6; 04.07.03

9612121



Ozone Depleting Substances Policy Statement

It is the policy of **Vishay Semiconductor GmbH** to

1. Meet all present and future national and international statutory requirements.
2. Regularly and continuously improve the performance of our products, processes, distribution and operating systems with respect to their impact on the health and safety of our employees and the public, as well as their impact on the environment.

It is particular concern to control or eliminate releases of those substances into the atmosphere which are known as ozone depleting substances (ODSs).

The Montreal Protocol (1987) and its London Amendments (1990) intend to severely restrict the use of ODSs and forbid their use within the next ten years. Various national and international initiatives are pressing for an earlier ban on these substances.

Vishay Semiconductor GmbH has been able to use its policy of continuous improvements to eliminate the use of ODSs listed in the following documents.

1. Annex A, B and list of transitional substances of the Montreal Protocol and the London Amendments respectively
2. Class I and II ozone depleting substances in the Clean Air Act Amendments of 1990 by the Environmental Protection Agency (EPA) in the USA
3. Council Decision 88/540/EEC and 91/690/EEC Annex A, B and C (transitional substances) respectively.

Vishay Semiconductor GmbH can certify that our semiconductors are not manufactured with ozone depleting substances and do not contain such substances.

**We reserve the right to make changes to improve technical design
and may do so without further notice.**

Parameters can vary in different applications. All operating parameters must be validated for each customer application by the customer. Should the buyer use Vishay Semiconductors products for any unintended or unauthorized application, the buyer shall indemnify Vishay Semiconductors against all claims, costs, damages, and expenses, arising out of, directly or indirectly, any claim of personal damage, injury or death associated with such unintended or unauthorized use.

Vishay Semiconductor GmbH, P.O.B. 3535, D-74025 Heilbronn, Germany
Telephone: 49 (0)7131 67 2831, Fax number: 49 (0)7131 67 2423



Notice

Specifications of the products displayed herein are subject to change without notice. Vishay Intertechnology, Inc., or anyone on its behalf, assumes no responsibility or liability for any errors or inaccuracies.

Information contained herein is intended to provide a product description only. No license, express or implied, by estoppel or otherwise, to any intellectual property rights is granted by this document. Except as provided in Vishay's terms and conditions of sale for such products, Vishay assumes no liability whatsoever, and disclaims any express or implied warranty, relating to sale and/or use of Vishay products including liability or warranties relating to fitness for a particular purpose, merchantability, or infringement of any patent, copyright, or other intellectual property right.

The products shown herein are not designed for use in medical, life-saving, or life-sustaining applications. Customers using or selling these products for use in such applications do so at their own risk and agree to fully indemnify Vishay for any damages resulting from such improper use or sale.