

Reflective Object Sensor
OPB700Z, OPB700ALZ, OPB701Z, OPB701ALZ

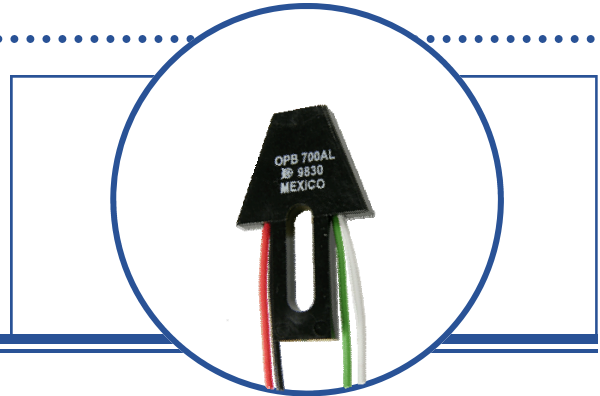

Features:

- Low profile to facilitate stacking
- Low cost plastic housing
- Choice of phototransistor or photodarlington output
- #26 AWG lead wire in 4" (101 mm), or 18" (457 mm) lengths



Description:

OPB700 and **OPB700ALZ** sensors consist of an infrared emitting diode and a NPN silicon phototransistor, mounted side-by-side on converging optical axes in a black plastic housing.

OPB701 and **OPB701ALZ** sensors consist of an infrared emitting diode and a NPN silicon photodarlington, mounted side-by-side on converging optical axes in a black plastic housing.

The interconnect wires for these devices are UL approved #26 AWG, with Teflon insulation, stripped and tinned. The **OPB700** and **OPB701** have 4" (101 mm) wire length while the **OPB700ALZ** and **OPB701ALZ** have 18" (457 mm) wire length.

Custom electrical, wire, cabling and connectors are available. Contact your local representative or OPTEK for more information.

Applications:

- Non-contact reflective object sensor
- Assembly line automation
- Machine automation
- Machine safety
- End of travel sensor
- Door sensor

Ordering Information				
Part Number	LED Peak Wavelength	Sensor	Reflection Distance Inch (mm)	Lead Length / Spacing
OPB700Z	890 nm	Transistor	0.200" (5.08mm)	4" / 26 AWG Wire
OPB700ALZ				18" / 26 AWG Wire
OPB701Z		Darlington		4" / 26 AWG Wire
OPB701ALZ				18" / 26 AWG Wire



RoHS

OPTEK reserves the right to make changes at any time in order to improve design and to supply the best product possible.

OPB700Z, OPB701Z

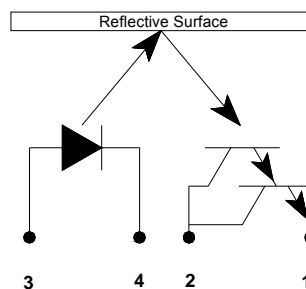
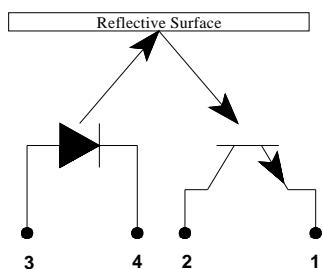
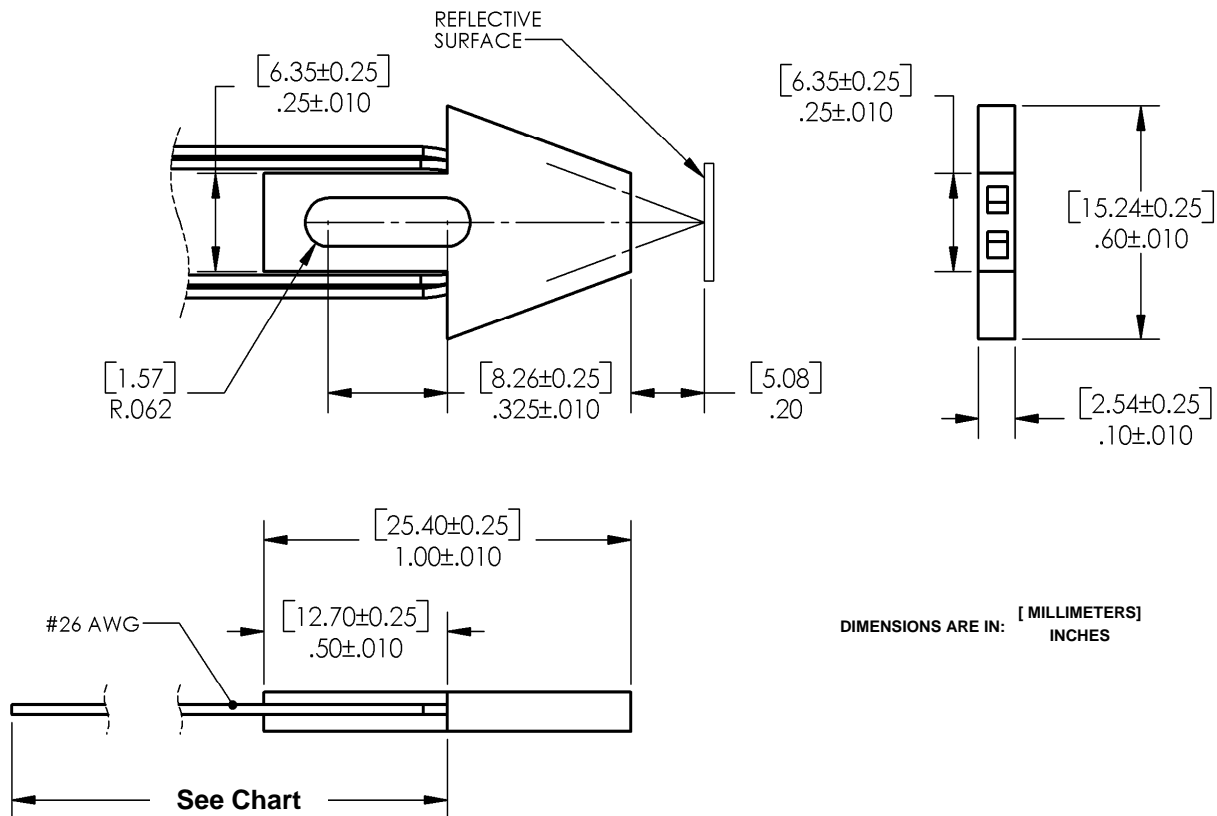

Part Number	Wire Length
OPB700Z	4" Min
OPB700ALZ	18" Min
OPB701Z	4" Min
OPB701ALZ	18" Min

OPB701			
Color/Pin #	LED	Color/Pin #	LED
Red-3	Anode	White-2	Collector
Black-4	Cathode	Green-1	Emitter

OPTEK reserves the right to make changes at any time in order to improve design and to supply the best product possible.

Absolute Maximum Ratings ($T_A=25^{\circ}\text{C}$ unless otherwise noted)

Storage Temperature Range	-40° C to + 125° C
Operating Temperature Range	-40° C to + 100° C
Lead Soldering Temperature	260° C

Input Diode

Continuous Forward Current	100 mA
Reverse Voltage	2 V
Power Dissipation ⁽¹⁾	80 mW

Output Phototransistor

Collector-Emitter Voltage OPB700Z, OPB700ALZ OPB701Z, OPB701ALZ	24 V 15 V
Emitter-Collector Voltage	5 V
Power Dissipation ⁽¹⁾	50 mW

Notes:

(1) Derate linearly 1.07 mW/°C above 25 ° C.

Electrical Characteristics ($T_A = 25^{\circ}\text{C}$ unless otherwise noted)

SYMBOL	PARAMETER	MIN	TYP	MAX	UNITS	TEST CONDITIONS
--------	-----------	-----	-----	-----	-------	-----------------

Input Diode

V_F	Forward Voltage	-	-	1.7	V	$I_F = 50\text{ mA}$
I_R	Reverse Current	-	-	100	μA	$V_R = 2\text{ V}$

Output Phototransistor

$V_{(BR)CEO}$	Collector-Emitter Breakdown Voltage	25	-	-	V	$I_C = 100\ \mu\text{A}$ $I_C = 100\ \mu\text{A}$
	OPB700Z, OPB700ALZ OPB701Z, OPB701ALZ	15	-	-	V	
$V_{(BR)ECO}$	Emitter-Collector Breakdown Voltage	5	-	-	V	$I_E = 100\ \mu\text{A}$
I_{CEO}	Collector Dark Current	-	-	100	nA	$V_{CE} = 10\text{ V}, I_F = 0, E_E = \leq 0.1\ \mu\text{W}/\text{cm}^2$ $V_{CE} = 10\text{ V}, I_F = 0, E_E = \leq 0.1\ \mu\text{W}/\text{cm}^2$
	OPB700Z, OPB700ALZ OPB701Z, OPB701ALZ	-	-	250	nA	

Notes:

(1) Measured using Eastman Kodak neutral white test card with 90% diffuse reflectance as a reflecting surface. Reference: Eastman Kodak, Catalog # E 152 7795.

OPTEK reserves the right to make changes at any time in order to improve design and to supply the best product possible.

Electrical Characteristics ($T_A = 25^\circ\text{C}$ unless otherwise noted)

SYMBOL	PARAMETER	MIN	TYP	MAX	UNITS	TEST CONDITIONS
--------	-----------	-----	-----	-----	-------	-----------------

Coupled Parameters OPB700Z, OPB700ALZ (Phototransistor)

$I_{C(ON)}$	Collector current	0.10	-	2.50	mA	$V_{CE} = 5.0V^{(1)}$, $I_F = 40mA$
$V_{CE(SAT)}$	Saturation Voltage	-	-	0.40	V	$I_C = 10\mu A$, $I_F = 40mA$
I_{CX}	Leakage Current	-	-	2.00	μA	$V_{CE} = 5.0V$, $I_F = 40mA$, NO Reflective Surface

Coupled Parameters OPB701Z, OPB701ALZ (Photodarlington)

$I_{C(ON)}$	Collector current	2.50	-	43.00	mA	$V_{CE} = 5.0V^{(1)}$
$V_{CE(SAT)}$	Saturation Voltage	-	-	1.10	V	$I_C = 10\mu A$, $I_F = 40mA$
I_{CX}	Leakage Current	-	-	20.0	μA	$V_{CE} = 5.0V$, $I_F = 40mA$, NO Reflective Surface

Notes:

- (1) Measured using Eastman Kodak neutral white test card with 90% diffuse reflectance as a reflecting surface. Reference: Eastman Kodak, Catalog # E 152 7795.

OPB700 - Normalized Collector Current vs Distance

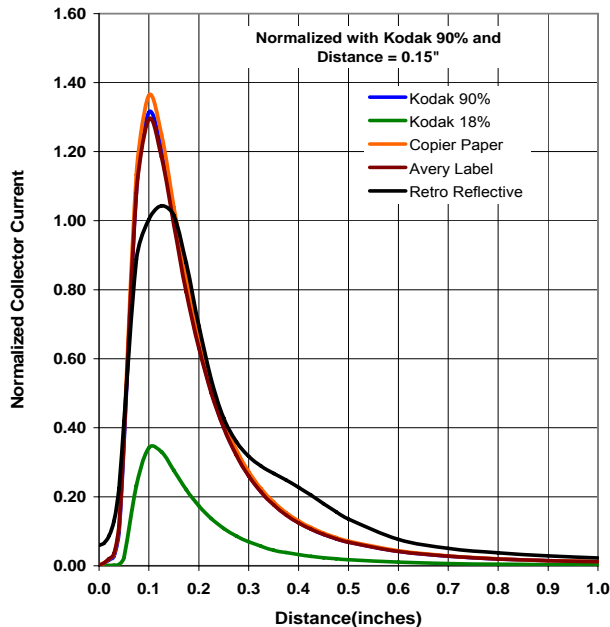

OPB700 - Normalized Collector Current vs Forward Current vs Temperature

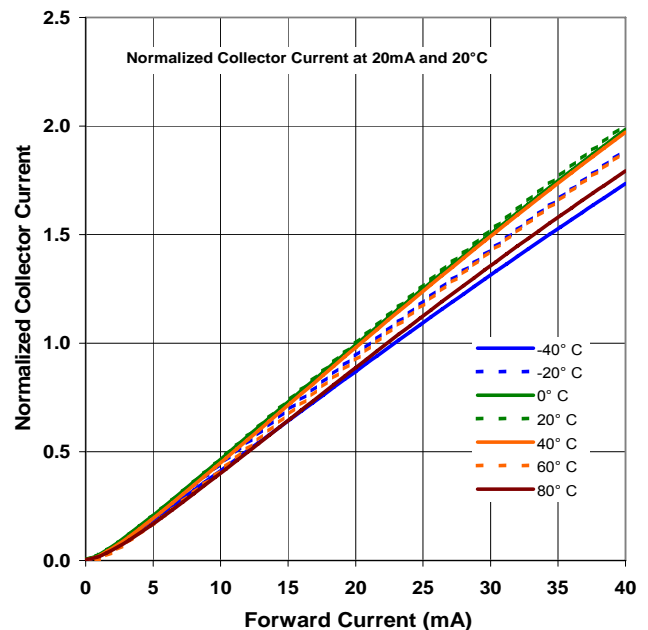

OPTEK reserves the right to make changes at any time in order to improve design and to supply the best product possible.

OPB701 - Normalized Collector Current vs Distance

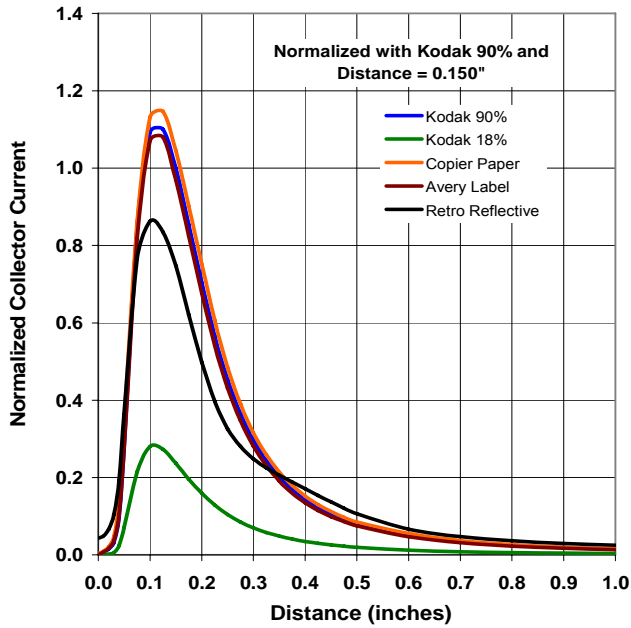

OPB701 - Normalized Collector Current vs Forward Current vs Temperature

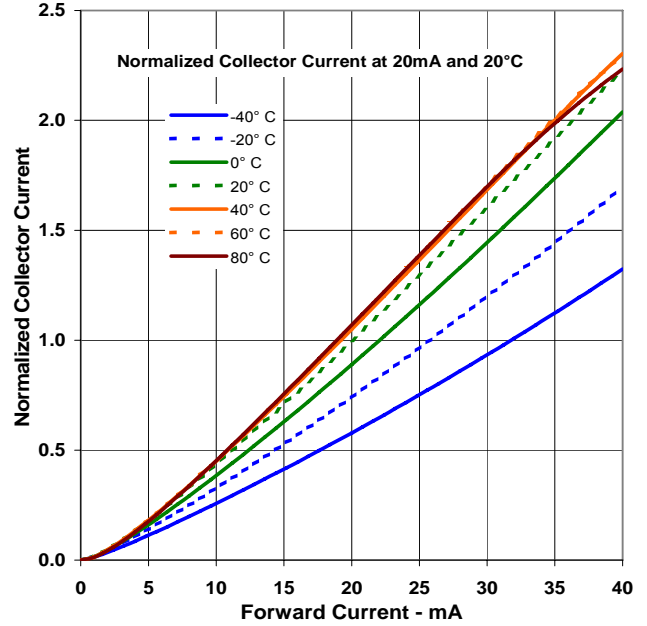

LED—Forward Voltage vs Forward Current vs Temperature

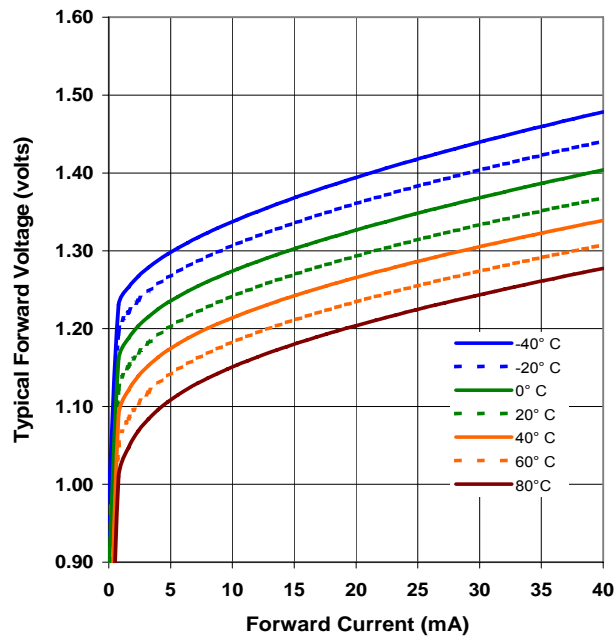

OPTEK reserves the right to make changes at any time in order to improve design and to supply the best product possible.